



Model Number

RAVE-D-GB

Radar sensor

Features

- Degree of protection IP67
- Differentiated detection of people and vehicles, each with one output relay
- Cross-traffic suppression and rotation direction monitoring
- Simplified adjustment options via remote control or integrated push buttons
- Wall and ceiling mountable

Product information

The RAVE-D is a radar sensor for harsh industrial environments.

The robust housing with IP67 degree of protection makes it the ideal door opener up to a height of 7 m. The housing concept enables time-saving mounting due to the convenient wall bracket and locking plate for adjusting the detection field. Differentiated detection of people and vehicles provides targeted door opening. This enables optimized transport routes and energy savings.

Release date: 2017-11-28 09:39 Date of issue: 2017-11-28 285647_eng.xml

Dimensions

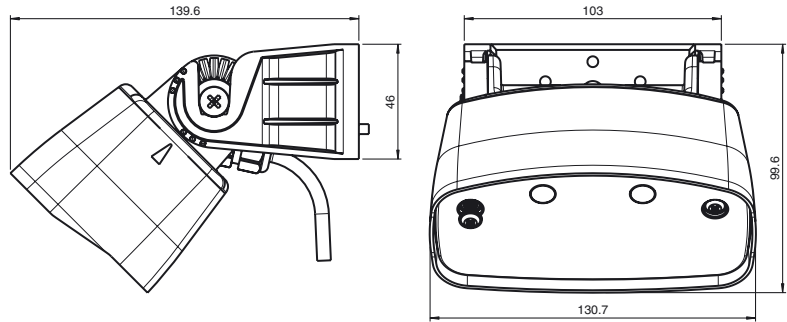

Electrical connection

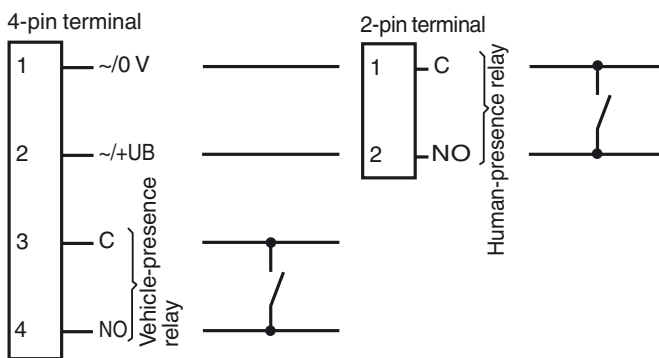

Indicators/operating means

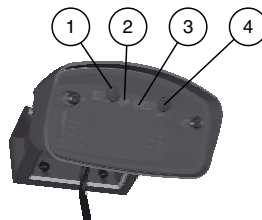

1	"MENU" control button
2	Green status indicator LED
3	Red status indicator LED
4	"VALUE" control button

Technical data

General specifications

Sensing range	9000 x 6500 mm (d x w) at installation height of 5000 mm and 45° angle 10000 x 5500 mm (d x w) at installation height of 7000 mm and 45° angle
Function principle	Microwave module
Detection speed	min. 0.1 m/s
Marking	CE
Setting angle	-90 ... 90 ° in 15 ° increments
Operating frequency	24.15 ... 24.25 GHz K-Band
Operating mode	Radar motion sensor
Transmitter radiated power (EIRP)	< 20 dBm

Functional safety related parameters

MTTF _d	620 a
Mission Time (T _M)	20 a
Diagnostic Coverage (DC)	0 %

Indicators/operating means

Function indicator	LED red/green
Control elements	Programming push-button for selection of operating modes : Direction detection , Cross traffic suppression , Vehicle detection , Switching type
Control elements	Adjustment for off delay
Control elements	Programming via 2 keys , alternative via remote control (Accessories ordered separately)

Electrical specifications

Operating voltage	U _B	12 ... 36 V DC , 12 ... 28 V AC
No-load supply current	I ₀	≤ 50 mA at 24 V DC
Power consumption	P ₀	≤ 1 W

Output

Switching type	NO/NC	
Signal output	2 relay outputs	
Switching voltage	max. 48 V AC / 48 V DC	
Switching current	max. 0.5 A AC / 1 A DC	
Switching power	max. 24 W / 60 VA	
De-energized delay	t _{off}	0.5 ... 300 s adjustable

Directive conformity

Radio and telecommunication terminal equipment	
Directive 2014/53/EU	yes This device can be used in all countries within the EU including the United Kingdom. Use in North America is not permitted. In other countries, all applicable national regulations must be observed.

Ambient conditions

Operating temperature	-20 ... 60 °C (-4 ... 140 °F)
Storage temperature	-30 ... 70 °C (-22 ... 158 °F)
Relative humidity	max. 90 % non-condensing

Mechanical specifications

Mounting height	max. 7000 mm
Degree of protection	IP67
Connection	plug-in screw terminals 4-pin and 2 pin , 8 m connecting cable included with delivery
Material	
Housing	ABS, anthracite
Mass	650 g
Dimensions	with Mounting bracket : 131 mm x 73 mm x 136 mm

Suitable series

Series	RAVE
--------	------

Functional principle

Microwave sensors are microwave scanners that use the principle of the Doppler radar. The most important requirement for microwave detection is that the object to be detected is moving. The microwave sensors emit microwaves of a defined frequency in order to detect people and large objects moving at speeds between 100 mm/sec. and 5 m/sec. The microwaves emitted by the emitter are reflected back from the ground or other surfaces to the receiver. If there is no motion in the monitored zone, the emitted and reflected frequencies are identical. Nothing is detected. If people, animals or objects are moving in the monitored zone, the reflected frequency changes and therefore triggers a detection. Based on the latest 24 GHz technology with integrated microprocessor control, these sensors provide a high degree of reliability even in difficult operating conditions. The 24 GHz frequency, known as the 'K-band,' is reserved by CETECOM for this application area worldwide. The RAVE series of sensors are equipped with intelligent functions to enable them to be used in a wide variety of applications. The cross-traffic suppression system can be configured so that the door only opens when vehicles or people approach it, while passing pedestrians are ignored.

Typical applications

- Opening impulse sensor for industrial doors
- Motion sensor for people and objects

Detection area



Accessories

RMS Remote Control

Infrared remote control for RMS series and RAVE

RADAR RC

Infrared remote control for radar sensors

Other suitable accessories can be found at www.pepperl-fuchs.com

Release date: 2017-11-28 09:39 Date of issue: 2017-11-28 285647_eng.xml

With direction detection, the opening impulse can be triggered based on the direction of motion. Depending on the setting, only movements towards or away from the sensor are detected.

Settings

The RAVE sensor is adjusted in programming mode directly on the device using two buttons: --> 8 = button/menu; 7 = button/value. The flashing sequence of the LEDs indicates the settings. With the RMS remote control, available as an accessory, the sensor can be easily and quickly programmed from the ground. The bidirectional infrared remote control with an LCD display and self-explanatory menu interface has a range of 10 m. Even sensors with considerable installation heights can be precisely and easily adjusted.

Model number for remote control: RMS remote control

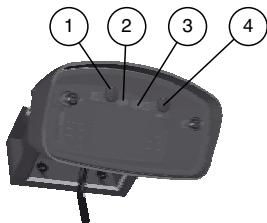

1	"MENU" control button
2	Green status indicator LED
3	Red status indicator LED
4	"VALUE" control button

1)

The following properties are adjustable:

1. Dimensions of the detection area

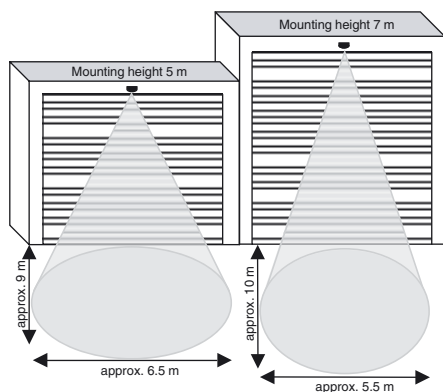

At maximum sensitivity and angle of incidence

2. Dimensions of the detection area

The size of the sensing area can be changed by adjusting the sensitivity using the buttons or remote control.



High sensitivity = Large area

Low sensitivity = small area

3. Position of the sensing area:

Snap-in positions are provided every 15 degrees to allow the sensor to be tilted depending on requirements.

To adjust the tilt angle, loosen the long screw, move the sensor into the required position (the sensor will snap into place) and tighten the long screw again.

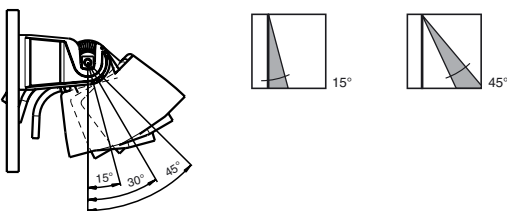

4. Inclined detection area

Installing the mounting bracket on an incline has the following effects on the detection field:

Release date: 2017-11-28 09:39 Date of issue: 2017-11-28 285647_eng.xml

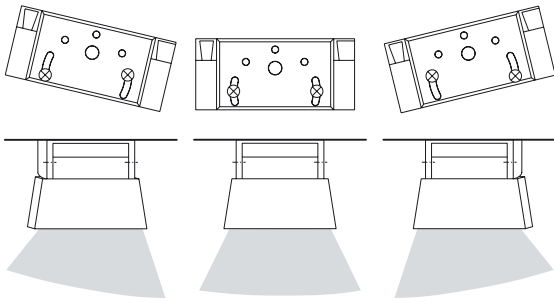

5. Detection without rotation direction monitoring

Forward/backward

6. Detection with rotation direction monitoring

Forward (toward the sensor)

Backward (away from the sensor)

7. Cross-traffic suppression

Without suppression: door opens even in the event of cross-traffic

With suppression: door remains closed in the event of cross-traffic

8. Detection of people/vehicles

The sensor evaluates movements of people and vehicles in different ways and switches the vehicle relay or the person relay according to the setting.

The ability to distinguish between people/vehicles makes it possible to open the door only for vehicles. Approaching people must use the side entry.

Function indicator

LED

Red/green flashing

Green

Flashing green 3x

Flashing red in quick succession

Flashing green in quick succession

Red/green flashing in quick succession.

Status

Sensor initialization in progress

Sensor ready for operation, no detection

Command received from remote control

Vehicle-presence relay active

Human-presence relay active

Vehicle-presence relay and human-presence relay both active

Application examples:

Distinguishes between people and vehicles

Example 1: Vehicle recognition at a door

Door controller with one switch input.

Output function for vehicle-presence relay "Vehicle forward".

Vehicle approaches: Vehicle-presence relay is activated.
The door opens.

Person approaches: Vehicle-presence relay is not activated. Door remains closed



Example 2: Door with vehicle recognition and separate entrance for people

Door control with two switching inputs (vehicle-presence relay and human-presence relay).

Output function for vehicle-presence relay "Vehicle forward". Output function for human-presence relay "Person forward". Relay configuration as per factory settings.*

Person approaches: Vehicle-presence relay is not activated. Door remains closed. Human-presence relay is activated. Entrance for people opens.

Vehicle approaches: Vehicle-presence relay is activated. The door opens. Human-presence relay is not activated. Entrance for people remains closed.

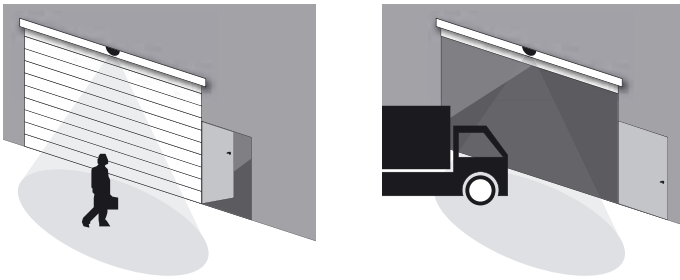

Example 3: Door with vehicle recognition without separate entrance for people

Door control with two switching inputs (vehicle-presence relay and human-presence relay). Output function for vehicle-presence relay "Vehicle forward". Output function for human-presence relay "Person forward". Relay configuration as per factory settings.*

Person approaches: Vehicle-presence relay is not activated. No action. Human-presence relay is activated. The door opens half-way.

Vehicle approaches: Vehicle-presence relay is activated. The door opens fully. Human-presence relay is not activated. No action.

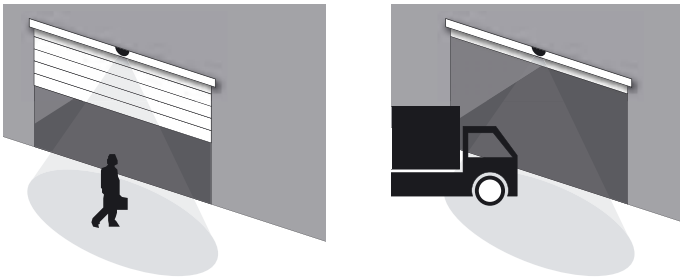

*) Vehicles crossing the detection range of the sensor may cause the human-presence relay to be activated unexpectedly.