

Illuminated pushbutton, 22mm, round, plastic, blue, pushbutton, raised, with holder for 3 elements, with holder !!! Phased-out product !!! SIRIUS ACT 3SU1 is successor Preferred successor type is >>3SU1001-0BB50-0AA0 + 3SU1500-0AA10-0AA0<<



Figure similar

Design of the product	Single device round
Enclosure	
Number of command points	1
Actuator	
Design of the operating mechanism	Illuminated pushbutton
Manner of function of the actuating element	Momentary contact type
Product extension optional Light source	Yes
Color	
• of the actuating element	Blue
Material of the actuating element	plastic
Shape of the actuating element	Raised pushbutton
Outer diameter of the actuating element	28.5 mm
Type of unlocking device	without
Number of switching positions	2
Front ring	
Product component front ring	Yes
Design of the front ring	Standard

Material of the front ring	plastic
Color of the front ring	black

Holder

Material of the holder	Plastic
------------------------	---------

General technical data

Product function	
• EMERGENCY OFF function	No
• EMERGENCY STOP function	No
Protection class IP	IP66
Vibration resistance	
• acc. to IEC 60068-2-6	20 ... 200 Hz: 5g
Operating frequency maximum	1 000 1/h
Mechanical service life (switching cycles)	
• typical	3 000 000
Equipment marking	
• acc. to DIN 40719 extended according to IEC 204-2 acc. to IEC 750	S
• acc. to DIN EN 61346-2	S
• acc. to DIN EN 81346-2	S

Connections/Terminals

Tightening torque of the screws in the bracket	1 ... 1.2 N·m
--	---------------



Ambient conditions



Ambient temperature	
• during operation	-25 ... +70 °C
• during storage	-40 ... +80 °C
Environmental category during operation acc. to IEC 60721	3K6

Installation/ mounting/ dimensions

Mounting type	front mounting
Shape of the installation opening	round
Mounting diameter	22 mm
Mounting height	12 mm
Installation width	29.5 mm
Installation depth	29 mm

Certificates/approvals

General Product Approval			Declaration of Conformity	Test Certificates	Marine / Shipping
				Special Test Certificate	
CSA	UL		EG-Konf.		ABS

Marine / Shipping			other		
			Confirmation	Miscellaneous	Environmental Confirmations
LRS	PRS	RINA			

Further information

Information- and Downloadcenter (Catalogs, Brochures,...)

<http://www.siemens.com/industrial-controls/catalogs>

Industry Mall (Online ordering system)

<https://mall.industry.siemens.com/mall/en/en/Catalog/product?mlfb=3SB3001-0BA51>

Cax online generator

<http://support.automation.siemens.com/WW/CAXorder/default.aspx?lang=en&mlfb=3SB3001-0BA51>

Service&Support (Manuals, Certificates, Characteristics, FAQs,...)

<https://support.industry.siemens.com/cs/ww/en/ps/3SB3001-0BA51>

Image database (product images, 2D dimension drawings, 3D models, device circuit diagrams, EPLAN macros, ...)

http://www.automation.siemens.com/bilddb/cax_de.aspx?mlfb=3SB3001-0BA51&lang=en

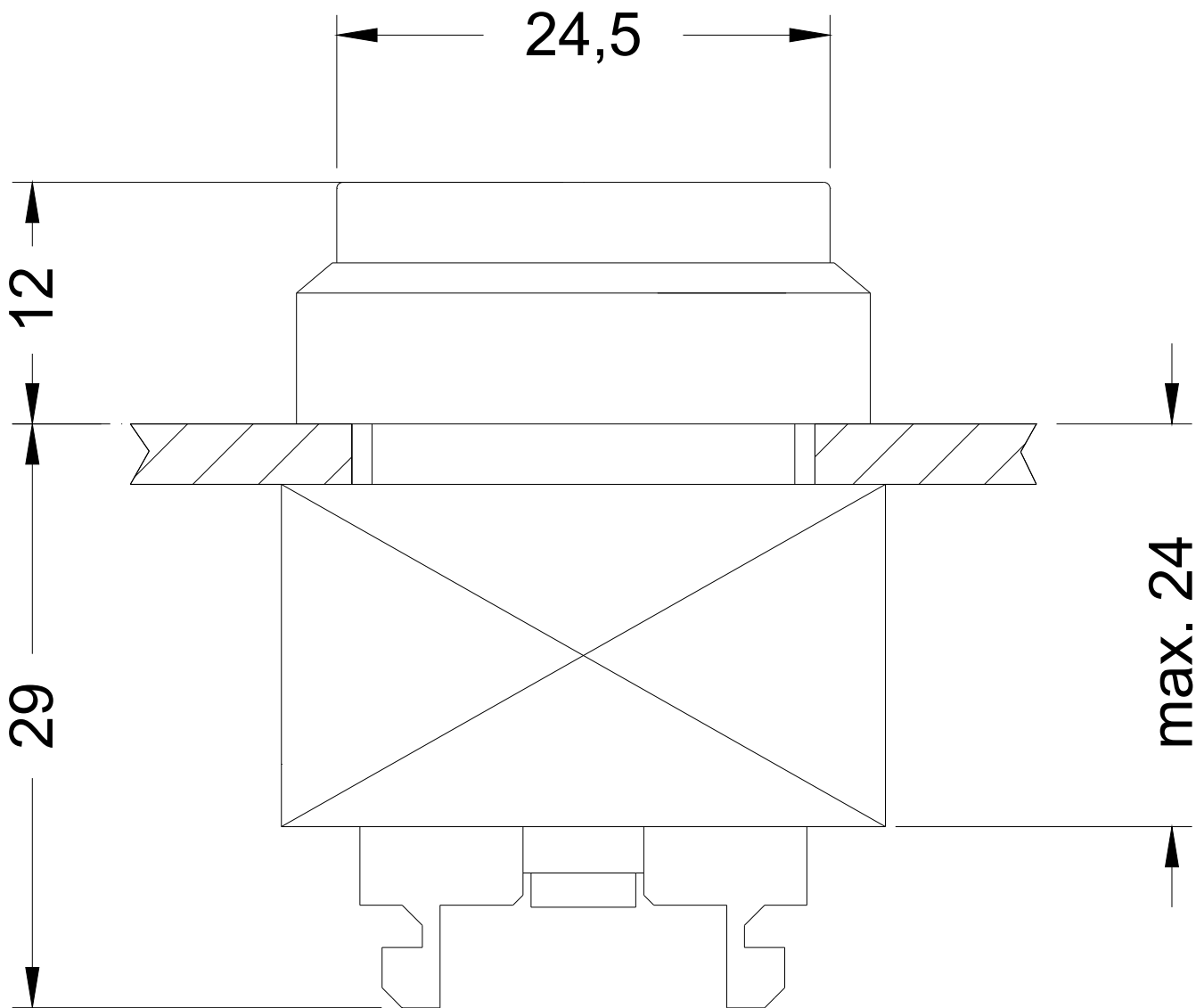

last modified:

09/25/2017