



**Pushbuttons, Indicating lights,
Selector switches and Stacklights**

Product Guide

- E22 Series
- 9100T Series
- E26 Series



**Innovative
Solutions
for Control
and Indication**

Contents

22.5mm operators – E22 Series

Description	Page	Description	Page
Pushbutton operators non-illuminating	4	Double-headed pushbutton operators suitable for illuminating	10
Double-headed pushbutton operators	4	Press to test light source units	10
Contact blocks	4	Key selector switches	11
Mushroom operators - Latched	5	Knob & lever selector switches non illuminating	12
Mushroom operators - Spring return	5	Knob & lever selector switches suitable for illuminating	13
Mushroom operators - Trigger action	5	Cam & contact block selection charts for selector switches	14
Push-Pull operators non-illuminating	6	Complete rotary cam selector switches	16
Push-Pull operators suitable for illuminating	6	Ammeter & voltmeter rotary cam selector switches	19
Light source units - push-pull operators	7	Legend plates	20
Indicating lights	8	Accessories	21
Light source units for indicating lights and illuminated pushbuttons	8	Enclosures - Polycarbonate	24
Bulbs	8	Enclosures - die cast aluminium	25
Direct voltage indicating lights	9	Assembled stations	26
Pushbutton operators suitable for illuminating	10	Technical data	27

30.5mm operators – 9100T Series

Description	Page	Description	Page
Pushbutton operators	32	Roto-push pushbuttons	38
Mechanical push operators	32	Joystick controllers	39
Illuminated pushbuttons	33	Legend plates	40
Cylinder lock pushbuttons	33	Accessories	41
Contact blocks	33	Assembled pushbutton stations	43
Knob or lever operated selector switches	34	Emergency stop stations	43
Key operated selector switches	35	Aluminium alloy enclosures	44
Standard indicating lights	36	Technical data	45
Pretest Indicating lights	37		

Stacklights – E26 Series

Description	Page	Description	Page
Product description	48	Technical data	54
Catalogue number selection guide	48	Application data	54
Light and xenon strobe modules	49	Mounting options and dimensions	55
Accessories	50	Dimensions	56
LEDs - Cluster or cylindrical	53		

Contents

E22 Series – pages 3-30

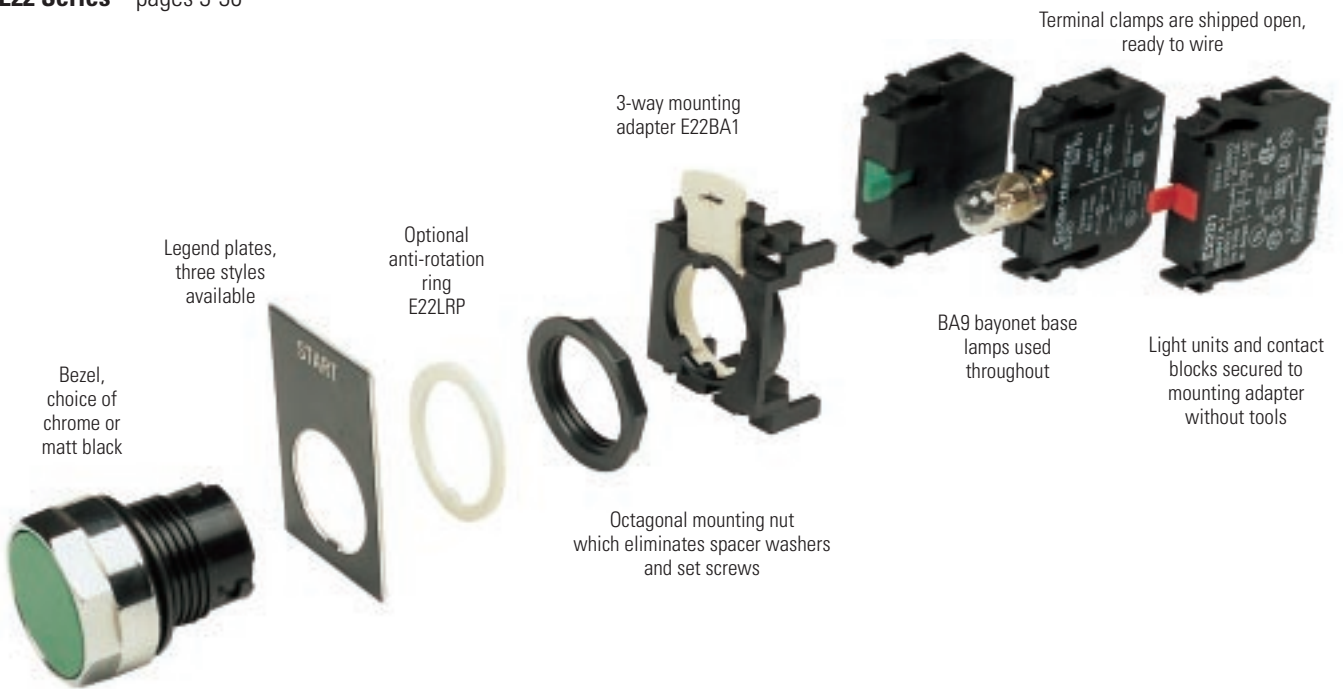

91000T Series – pages 31-45



E26 Series – pages 47-56

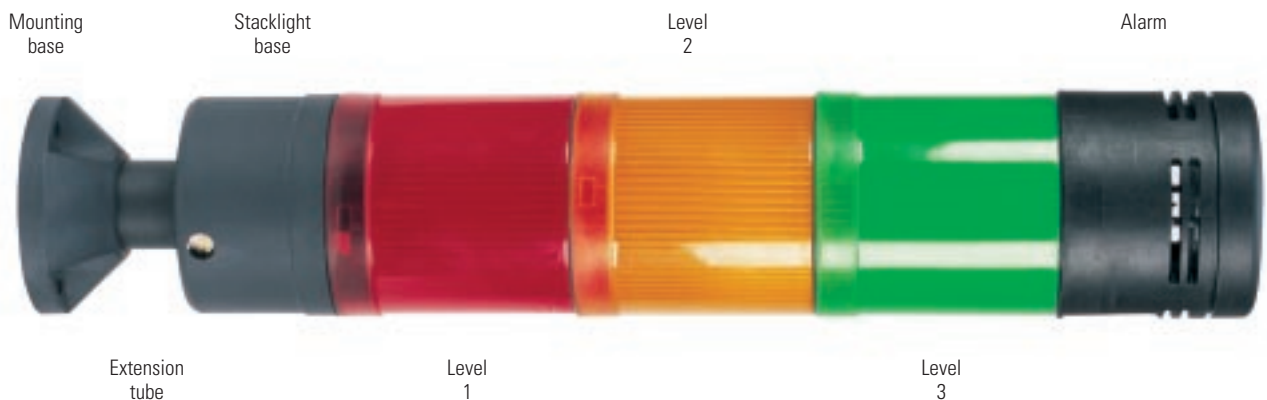

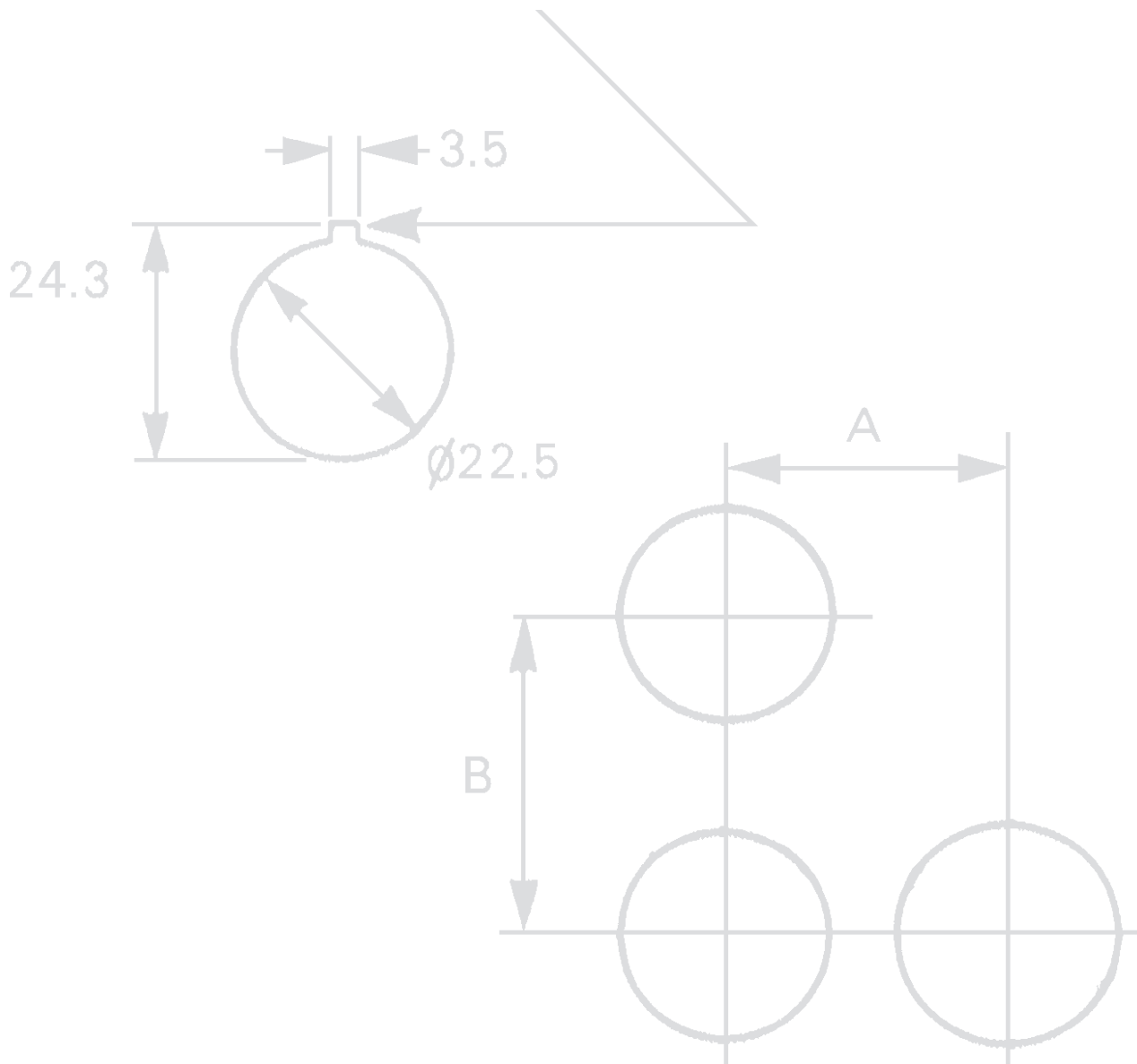

22.5mm operators – E22 Series

Description

Pushbutton operators non-illuminating	4
Double-headed pushbutton operators	4
Contact blocks	4
Mushroom operators - Latched	5
Mushroom operators - Spring return	5
Mushroom operators - Trigger action	5
Push-Pull operators non-illuminating	6
Push-Pull operators suitable for illuminating	6
Light source units - push-pull operators	7
Indicating lights	8
Light source units for indicating lights and illuminated pushbuttons	8
Bulbs	8
Direct voltage indicating lights	9
Pushbutton operators suitable for illuminating	10

Page





Description

Double-headed pushbutton operators suitable for illuminating	10
Press to test light source units	10
Key selector switches	11
Knob & lever selector switches non illuminating	12
Knob & lever selector switches suitable for illuminating	13
Cam & contact block selection charts for selector switches	14
Complete rotary cam selector switches	16
Ammeter & voltmeter rotary cam selector switches	19
Legend plates	20
Accessories	21
Enclosures - Polycarbonate	24
Enclosures - die cast aluminium	25
Assembled stations	26
Technical data	27

Page

E22 Series - Non-illuminating operators, double-headed operators and contact blocks

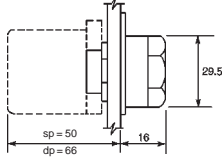
Pushbutton operators non-illuminating *See notes 3,4 & 5*

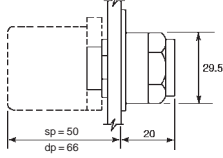
Chrome bezel	Black bezel	Button colour	Catalogue numbers Chrome bezel	Black bezel	Overall dimensions (mm)
Flush  25mm diameter push		Black Red Green Yellow White Blue Grey	E22P1 E22P2 E22P3 E22P4 E22P5 E22P6 E22P7	E22PB1 E22PB2 E22PB3 E22PB4 E22PB5 E22PB6 E22PB7	 Weight 0.043kg
Extended  25mm diameter push		Black Red Green Yellow White Blue Grey	E22E1 E22E2 E22E3 E22E4 E22E5 E22E6 E22E7	E22EB1 E22EB2 E22EB3 E22EB4 E22EB5 E22EB6 E22EB7	 Weight 0.043kg

Full shroud bezel operator Add the letter **F** to the flush button catalogue number eg **E22PF1**

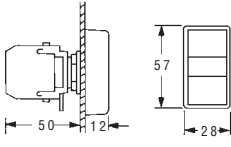

Double headed pushbutton operators *See note 6*

Description	Colour of operators	Marking	Ingress protection	Catalogue numbers Black bezel	Overall dimensions (mm)
	Green - Red	Unmarked	IP40 IP65	E22DB1A11 E22DB1B11	
	Green - Red	I O	IP40 IP65	E22DB1A21 E22DB1B21	

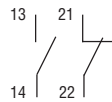
Assembled operators

Description	Colour of operators	Marking	Ingress protection	Contact block/ light unit	Operator black bezel	Circuit diagram	Catalogue numbers Black bezel
2 Flush buttons	Green	I	IP40	E22B2	E22DB1A21		E22DB1A21C
	Red	O	IP65	E22B1			E22DB1B21C

Contact blocks

 Single pole	 Double pole	Description	Catalogue numbers		Weight (kg)
			Screw terminals	Push-on terminals	
		1N.C.	E22B1	E22BF1	0.013
		1N.O.	E22B2	E22BF2	0.013
		1N.O. - 1N.C.	E22B11	E22BF11	0.022
		2N.O.	E22B20	E22BF20	0.022
		1N.O. early make	E22B3	E22BF3	0.013
		1N.C. late break	E22B4*	E22BF4*	0.013
		1N.C. low power	E22B1E	—	0.013
		1N.O. low power	E22B2E	—	0.013

* Cannot be used with 5 way adaptor

Notes: 3. Mounting adaptor for 3 contact blocks included.

4. Use operator plug E22BA2 to operate centre contact block.

5. For printed operators see page 9

6. Only 2 contact blocks can be fitted.

7. See page 30 for technical information

E22 Series - Mushroom operators - latched, spring return and trigger action

Mushroom operators – latched *See notes 5 & 6*

Chrome bezel	Black bezel	Button colour	Catalogue numbers Chrome bezel	Black bezel	Overall dimensions (mm)
Push to latch-twist to release (6)		Black Red Green Yellow Blue	E22ML1 E22ML2 E22ML3 E22ML4 E22ML6	E22MLB1 E22MLB2 E22MLB3 E22MLB4 E22MLB6	 Weight 0.039kg
28mm diameter head					
40mm diameter head		Black Red Green Yellow Blue	E22LL1 E22LL2 E22LL3 E22LL4 E22LL6	E22LLB1 E22LLB2 E22LLB3 E22LLB4 E22LLB6	 Weight 0.041kg
Push to latch-pull to release		Red (marked EMERGENCY STOP) Black Red Green Aluminium head Red	E22JPL2N8 E22JPL1 E22JPL2 E22JPL3 E22JL2	E22JPLB2N8 E22JPLB1 E22JPLB2 E22JPLB3 E22JLB2	 Weight 0.043kg
50mm diameter head					
Push to latch-key release (6)		Black Red Green	E22G1 E22G2 E22G3	E22GB1 E22GB2 E22GB3	 Weight 0.043kg
40mm diameter head					

Mushroom operators – spring return *See notes 3, 4 & 5*

28mm diameter head		Black Red Green Yellow Blue	E22M1 E22M2 E22M3 E22M4 E22M6	E22MB1 E22MB2 E22MB3 E22MB4 E22MB6	 Weight 0.039kg
40mm diameter head		Black Red Green Yellow Blue	E22L1 E22L2 E22L3 E22L4 E22L6	E22LB1 E22LB2 E22LB3 E22LB4 E22LB6	 Weight 0.041kg
50mm diameter head		Black Red Green Aluminium head Red Red (marked EMERGENCY STOP)	E22JP1 E22JP2 E22JP3 E22J2 E22J2N8	E22JPB1 E22JPB2 E22JPB3 E22JB2 E22JB2N8	 Weight 0.043kg

Trigger action operators – spring return *See note 7*

40mm red twist-to-release with red arrow legend		1N.C 2N.C	E22LTA2QB E22LTA2QE	– –	
40mm red twist-to-release with white Emergency Machine Off legend		1N.C	E22LTA2N123QB	–	
Rectangular safety emergency stop shroud		Yellow	E22MGTA	–	

E22 Series - Push-pull operators - non-illuminating and suitable for illuminating

Push-Pull operators non-illuminating *See note 12*

Chrome bezel	Black bezel	Head diameter (mm)	Catalogue numbers		Overall dimensions (mm)
			Chrome bezel	Black bezel	
2 position stayput					
		40	Red push (marked EMERGENCY STOP) E22ED2N8	E22EDB2N8	
		40	Operators without markings E22ED*	E22EDB*	
		29.5	E22EH*	E22EHB*	
3 position spring return to centre (13)					
		40	Red push (marked EMERGENCY STOP) E22FD2N8	E22FDB2N8	
		40	Operators without markings E22FD*	E22FDB*	
		29.5	E22FH*	E22FHB*	

Weight 0.032kg

Push-Pull operators suitable for illuminating *See note 12*

2 position stayput					
		40	Red push (marked EMERGENCY STOP) E22GD2N8	E22GDB2N8	
		40	Operators without markings E22GD*	E22GDB*	
		29.5	E22GH*	E22GHB*	
3 position spring return to centre (13)					
		40	Red push (marked EMERGENCY STOP) E22HD2N8	E22HDB2N8	
		40	Operators without markings E22HD*	E22HDB*	
		29.5	E22HH*	E22HDB*	

Weight 0.032kg

Mushroom operators suitable for illuminating *See note 12*

Push to latch – Pull to release		Red	E22JPT2	E22JPTB2
		Green	E22JPT3	E22JPTB3
		Yellow	E22JPT4	E22JPTB4
		White	E22JPT5	E22JPTB5
		Blue	E22JPT6	E22JPTB6
		Amber	E22JPT9	E22JPTB9
		Clear	E22JPT0	E22JPTB0

50mm diameter head

Weight 0.043kg

Colour code selection for operator pushes 29.5 & 40 mm dia.

Colour	Code	Colour	Code	Colour	Code
Black	1	Yellow	4	Grey	7
Red	2	White	5	Amber	9
Green	3	Blue	6	Clear	0

* Add push colour selection code from table above

Notes:

10 Transformers E22TL2 to 4 will accommodate 2 contact blocks.



Transformer E22TL1 will not accommodate contact blocks.

12 Operators will accommodate 2 contact blocks.

13 Contact block E22B2 can not be used on 3 position Push Pulls.

E22 Series - Push-pull operators - light source units

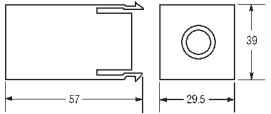
Light source units – push-pull operators *BA9s bayonet fitting. Bulb supplied with unit*

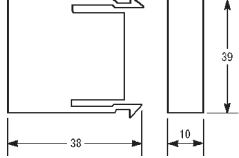

	Description	Supply voltage		Catalogue numbers	Overall dimensions (mm)	Weight (kg)
		50Hz	60Hz			
	Transformer (10) 6V secondary	110	120	E22TL1		0.08
		240	240	E22TL2		0.08
		380/415	–	E22TL3		0.08
		440	480	E22TL4		0.08
	Resistor unit	110/120V 60V bulb		E22R2		0.018
	Direct voltage	6.3V (1W)		E22D6		0.018
		12V (1.2W)		E22D12		0.018
		24V (1.2W)		E22D24		0.018
		50V (1W)		E22D50		0.018
		60V (1.2W)		E22D60		0.018
	Without bulb		E22D	0.018		

Bulbs For use with E22D above. See page 8 for LED type bulbs.

Description	Operating voltage	Catalogue numbers	Operating voltage	Catalogue numbers
Type BA9s	6 (1W) flasher	28-2225-26	24 (1.2W)	28-2225-30
bayonet	6.3 (1W)	28-2225-72	50 (1W)	28-2225-31
bulb	12 (1.2W)	28-2225-29	60 (1.2W)	28-2225-32

Contact block selection chart *See note 13*

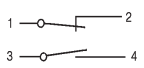
O = circuit open X = circuit closed

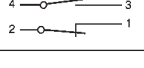
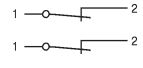
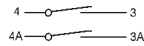
2 position push-pull		Circuit	Catalogue numbers	3 position push-pull			Circuit	Catalogue numbers
Pulled	Pushed			Pulled	Centre	Pushed		
X	O		E22B1	X	O	O		E22B1
O	X			X	X	O		
O	X		E22B11	X	O	O		E22B1
O	X			O	O	X		
O	X		E22B20					
O	X							

Typical push-pull applications *BA9s bayonet fitting. Bulb supplied with unit*

2 position push-pull with E22B1

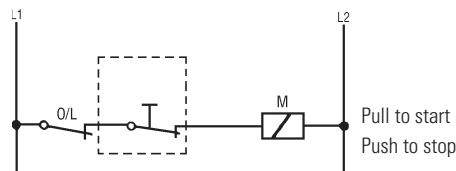

3 position push-pull with E22B1 & E22B5

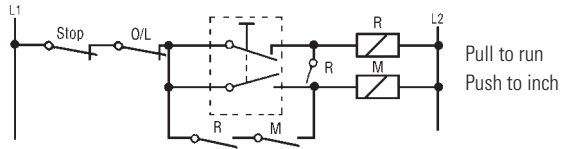

3 position push-pull with E22B1 & E22B4

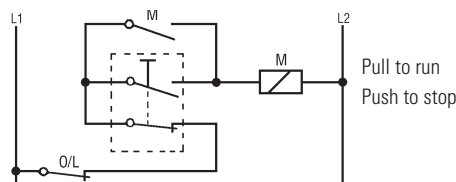

3 position push-pull with E22B1 & E22B5

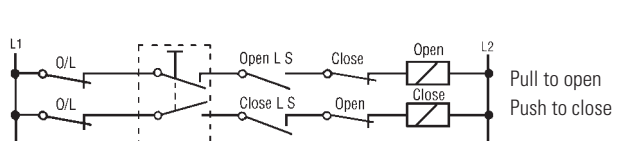



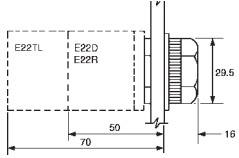

E22 Series - Indicating lights, light sources and bulbs

Indicating lights with plastic lens

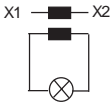
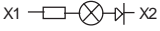
Description		Lens colour	Catalogue numbers Standard lens	Lens suitable for printing (7)	Overall dimensions (mm)
	Standard	Red	E22H2	E22A2	
	Printable	Green	E22H3	E22A3	
		Yellow	E22H4	E22A4	
		White	E22H5	E22A5	
		Blue	E22H6	E22A6	
		Amber	E22H9	E22A9	
		Clear	E22H0	E22A0	
Weight 0.023kg					

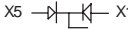
Light source units *BA9s bayonet fitting. Bulb supplied with unit.*

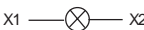
Description Operator unit	Circuit diagram	Supply voltage 50Hz	60Hz	Catalogue numbers	Weight (kg)
 Transformer (10) 6V secondary		110	120	E22TL1	0.08
		240	220	E22TL2	0.08
		380/415	—	E22TL3	0.08
		440	480	E22TL4	0.08
Resistor/Diode (110V bulb) (8) Resistor unit (60V bulb)	 	220/240ac		E22R1	0.018
		110/120ac		E22R2	0.018
Single diode unit Double diode unit	 	6 – 120dc		E22D1	0.018
		6 – 120dc		E22D2	0.018
Direct voltage 		6Vdc (1W)		E22D6	0.018
		12Vdc (1.2W)		E22D12	0.018
		24Vdc (1.2W)		E22D24	0.018
		50Vdc (1W)		E22D50	0.018
		110Vdc (2.2W) (8)		E22D110	0.018
		Without bulb		E22D	0.018

For operator light source units with push-on terminals add the letter **F** to the light source catalogue number eg **E22TLF1**

Bulbs

Filament and Neon type bulbs For use with E22D and E22R above.

Description	Operating voltage	Catalogue numbers	Description	Operating voltage	Catalogue numbers
Filament type	6V (1W) flasher	28-2225-26	Neon type	50V (1W)	28-2225-31
	6.3V (1W)	28-2225-72		60V (1.2W)	28-2225-32
	12V (1.2W)	28-2225-29		110V (2.2W) (8)	28-2225-24
	24V (1.2W)	28-2225-30		110V (0.8mA)	28-2225-48
	28V (1.12W)	28-2225-73		240V (1.5mA)	28-2225-49





LED bulbs

Colour	Catalogue numbers				Voltage code	
	Upto 60Vac/dc	120Vac	120Vdc	135Vac/dc	Voltage	Code
Blue	E22LED*BN	E22LED120BA	E22LED120BD	E22LED135BD	10Vac – 6Vdc	006
Green	E22LED*GN	E22LED120GA	E22LED120GD	E22LED135GD	12Vac – 12Vdc	012
Orange	E22LED*ON	E22LED120OA	E22LED120OD	E22LED135OD	24Vac – 24Vdc	024
Red	E22LED*RN	E22LED120RA	E22LED120RD	E22LED135RD	35Vac – 35Vdc	035
White	E22LED*WN	E22LED120WA	-	E22LED135WD	48Vac – 48Vdc	048
Yellow	E22LED*YN	E22LED120YA	E22LED120YD	E22LED135YD	60Vac – 60Vdc	060

*Add voltage code alongside to complete catalogue number

E22 Series - Direct voltage indicating lights

Direct voltage type – bulb not included (order bulb separately)

Description	Supply voltage/ wattage	Lens colour	Catalogue numbers		Lens with printable insert			
			Standard lens IP40	IP65	IP40	IP65		
Direct voltage without resistor (Excludes bulb)  X1 —  — X2	6 - 130V (2.6W max.) (Not suitable for 240V bulb.)	No lens (2)	E22HVP	E22HV	E22HVP	E22HV		
		Red	E22HVP2	E22HV2	E22HVR2	E22HVA2		
		Green	E22HVP3	E22HV3	E22HVR3	E22HVA3		
		Yellow	E22HVP4	E22HV4	E22HVR4	E22HVA4		
		White	E22HVP5	E22HV5	E22HVR5	E22HVA5		
		Blue	E22HVP6	E22HV6	E22HVR6	E22HVA6		
		Amber	E22HVP9	E22HV9	E22HVR9	E22HVA9		
		Clear	E22HVP0	E22HV0	E22HVR0	E22HVA0		
		Direct voltage with built-in resistor (Excludes bulb)  X1 —  —  — X2	220/240V input 110V output (2.6W max.) Use filament bulb only	No lens (2)	E22HRP	E22HR	E22HRP	E22HR
				Red	E22HRP2	E22HR2	E22HRR2	E22HRA2
Green	E22HRP3			E22HR3	E22HRR3	E22HRA3		
Yellow	E22HRP4			E22HR4	E22HRR4	E22HRA4		
White	E22HRP5			E22HR5	E22HRR5	E22HRA5		
Blue	E22HRP6			E22HR6	E22HRR6	E22HRA6		
Amber	E22HRP9			E22HR9	E22HRR9	E22HRA9		
Clear	E22HRP0			E22HR0	E22HRR0	E22HRA0		

Printed legends for operators and indicating lights

Add the following suffix code to the selected catalogue number. For legends not listed please refer to Eaton.

Legend	Suffix	Legend	Suffix	Legend	Suffix
Close	N11	Off	N24	Motor running	N56
Open	N26	On	N25	Motor stopped	N57
Power on	N80	Supply on	N61		

Notes:

- 2 Order lens and/or insert separately. See page 23
- 7 For printed inserts see page 23
- 8 For use with indicating lights only
- 10 Transformers E22TL2 to 4 will accommodate 2 contact blocks.
Transformer E22TL1 does not accommodate contact blocks.

Light source unit master test applications

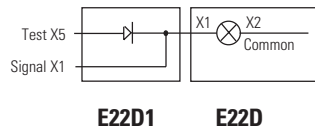
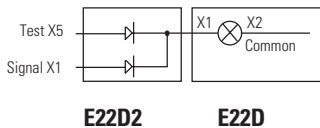

Mounting position for light source units

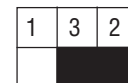



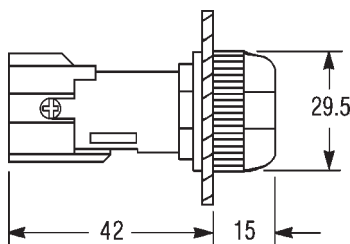



Dimensions (mm)

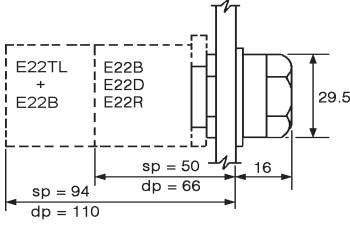

Weight: 0.022kg

E22 Series - Operators suitable for illuminating and press to test light source units

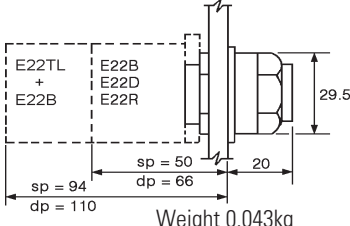
Pushbutton operators suitable for illuminating *See notes 7, 9 & 11*

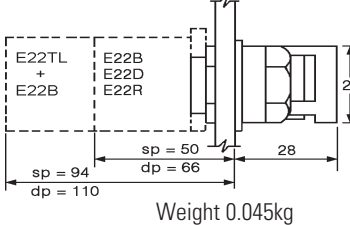
Chrome bezel	Black bezel	Lens colour	Catalogue numbers Chrome bezel	Black bezel	Overall dimensions (mm)
Flush button 		Red Green Yellow White Blue Amber Clear	E22N2 E22N3 E22N4 E22N5 E22N6 E22N9 E22N0	E22NB2 E22NB3 E22NB4 E22NB5 E22NB6 E22NB9 E22NB0	 Weight 0.043kg
Extended button 		Red Green Yellow White Blue Amber Clear	E22T2 E22T3 E22T4 E22T5 E22T6 E22T9 E22T0	E22TB2 E22TB3 E22TB4 E22TB5 E22TB6 E22TB9 E22TB0	 Weight 0.043kg
Full shroud 		Red Green Yellow White Blue Amber Clear	E22TX2 E22TX3 E22TX4 E22TX5 E22TX6 E22TX9 E22TX0	— — — — — — —	 Weight 0.045kg

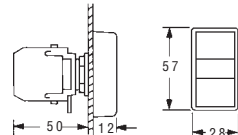

Double headed pushbutton operators *See note 6*

Description	Colour of operators	Marking	Ingress protection	Catalogue numbers Black bezel	Overall dimensions (mm)
2 Flush buttons & 1 pilot light with clear lens 	Green - Red	Unmarked	IP40 IP65	E22DB1A10 E22DB1B10	
	Green - Red	I O	IP40 IP65	E22DB1A20 E22DB1B20	

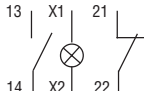
Assembled operators

Description	Colour of operators	Marking	Ingress protection	Contact block/ light unit	Operator black bezel	Circuit diagram	Catalogue numbers Black bezel
2 Flush buttons & 1 pilot light with clear lens	Green	I	IP40	E22B2	E22DB1A20		E22DB1A20X1C
	Red	O	IP65	E22B1 E22D			E22DB1B20X1C

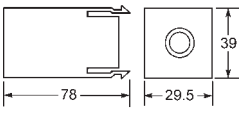
Press to test light source units *For use with illuminated operators*

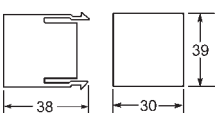
Description	Supply voltage 50Hz	60Hz	Catalogue numbers	Overall dimensions (mm)
Transformer 6V filament bulb supplied  6V secondary	110 240	120 220	E22TL1C E22TL2C	 Weight 0.106kg
Resistor unit 60V filament bulb supplied 	110/120V		E22R2C	 Weight 0.044kg
Direct voltage Filament bulb supplied	12V 24V 50V		E22D12C E22D24C E22D50C	

Contact blocks

A light source unit ordered from the table alongside comes complete with 1N.O. & 1N.C. contact blocks.
If the pushbutton is required to be used without a light source unit, select the contact blocks from page 4.

Press to test circuit diagram

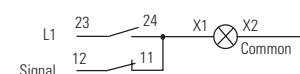

E22 Series - Key selector switches



Key selector switches *See note 14*

Chrome bezel



Black bezel

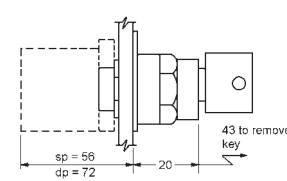

Description	Key removal position	Cam number	Catalogue numbers		Overall dimensions (mm)	
			Chrome bezel	Black bezel		
2 Position						
Stayput 	Right & left	2	E22K53	E22KB53	 <p>Weight 0.055kg</p>	
Spring return from right to left	Left only	2	E22K62	E22KB62		
2 Position						
Stayput 	Centre & right	2	E22KF5	E22KBF5		
Spring return from right to centre	Centre	2	E22KE4	E22KBE4		
3 Position						
Stayput & right 	Left, centre	1 2	E22KG7 E22KH7	E22KBG7 E22KBH7		
Spring return from left to centre	Centre & right	1 2	E22KJ5 E22KK5	E22KBJ5 E22KBK5		
Spring return from right and left to centre	Centre	1 2	E22KL4 E22KM4	E22KBL4 E22KBM4		
Spring return from right to centre	Left & centre	1 2	E22KN6 E22KP6	E22KBN6 E22KBP6		

Alternative key removal position selection

To select an alternative key removal position change the last digit of the listed catalogue number with a code from the table below. e.g. **E22KG6** is a 3 position switch with the key removable from left and centre. Key removal in a spring return position is not available.

Key removal position	Code	Key removal position	Code	Key removal position	Code	Key removal position	Code
Right only	1	Right & left	3	Right & centre	5	Right, left & centre	7
Left only	2	Centre only	4	Left & centre	6		

Special lock selection

Key operated devices listed above are supplied with a standard lock and key, ref. no. 92239. Different locks and keys are available on request.

Notes:

- 6 Only 2 contact blocks can be fitted.
- 7 For printed inserts see page 23
- 9 Operators will accommodate 2 contact blocks and 1 direct unit or 1 transformer
- 11 For printed operators see page 23
- 14 For contact block sequences see pages 14 & 15

Selector switch switching angles



E22 Series - Knob and lever selector switches non illuminating

Selector switches non-illuminating *See note 14*

Chrome bezel



Black bezel



Knob operator



Chrome bezel





Black bezel

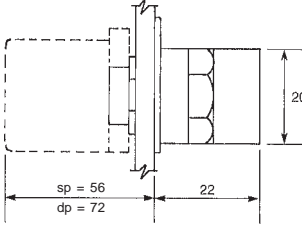

Lever operator

Description	Cam number	Catalogue numbers		Overall dimensions (mm)	
		Chrome bezel	Black bezel		
Knob selector switch (black)					
2 Position 					
Stayput	2	E22X51	E22XB51		
Spring return from right to left	2	E22X61	E22XB61		
2 Position 					
Stayput	2	E22XF1	E22XBF1		
Spring return from right to centre	2	E22XE1	E22XBE1		
3 Position 					
Stayput	1	E22XG1	E22XBG1		
	2	E22XH1	E22XBH1		
Spring return from left to centre	1	E22XJ1	E22XBJ1		
	2	E22XK1	E22XBK1		
Spring return from right and left to centre	1	E22XL1	E22XBL1		
	2	E22XM1	E22XBM1		
Spring return from right to centre	1	E22XN1	E22XBN1		
	2	E22XP1	E22XBP1		
				Weight 0.043kg	

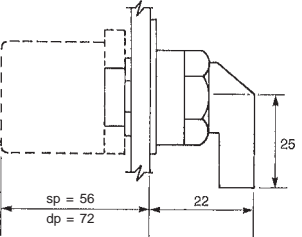
Lever selector switch (black)

2 Position 					
Stayput	2	E22V51	E22VB51		
Spring return from right to left	2	E22V61	E22VB61		
2 Position 					
Stayput	2	E22VF1	E22VBF1		
Spring return from right to centre	2	E22VE1	E22VBE1		
3 Position 					
Stayput	1	E22VG1	E22VBG1		
	2	E22VH1	E22VBH1		
Spring return from left to centre	1	E22VJ1	E22VBJ1		
	2	E22VK1	E22VBK1		
Spring return from right and left to centre	1	E22VL1	E22VBL1		
	2	E22VM1	E22VBM1		
Spring return from right to centre	1	E22VN1	E22VBN1		
	2	E22VP1	E22VBP1		
				Weight 0.043kg	

Note:

Different colour knobs and levers are available. Please contact Eaton.

Selector switches suitable for illuminating *See note 14*

Chrome bezel



Black bezel



Knob operator

Chrome bezel



Black bezel



Lever operator

Description	Cam number	Catalogue numbers Chrome bezel	Black bezel	Overall dimensions (mm)
-------------	------------	-----------------------------------	-------------	-------------------------

Knob selector switch (red) (15)

2 Position



Stayput	2	E22S52	E22SB52
Spring return from right to left	2	E22S62	E22SB62

2 Position



Stayput	2	E22SF2	E22SBF2
Spring return from right to centre	2	E22SE2	E22SBE2

3 Position



Stayput	1	E22SG2	E22SBG2
	2	E22SH2	E22SBH2
Spring return from left to centre	1	E22SJ2	E22SBJ2
	2	E22SK2	E22SBK2
Spring return from right and left to centre	1	E22SL2	E22SBL2
	2	E22SM2	E22SBM2
Spring return from right to centre	1	E22SN2	E22SBN2
	2	E22SP2	E22SBP2

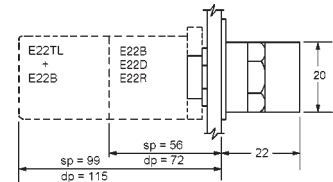

Weight 0.043kg

Lever selector switch (red) (15)

2 Position



Stayput	2	E22W52	E22WB52
Spring return from right to left	2	E22W62	E22WB62

2 Position



Stayput	2	E22WF2	E22WBF2
Spring return from right to centre	2	E22WE2	E22WBE2

3 Position



Stayput	1	E22WG2	E22WBG2
	2	E22WH2	E22WBH2
Spring return from left to centre	1	E22WJ2	E22WBJ2
	2	E22WK2	E22WBK2
Spring return from right and left to centre	1	E22WL2	E22WBL2
	2	E22WM2	E22WBM2
Spring return from right to centre	1	E22WN2	E22WBN2
	2	E22WP2	E22WBP2

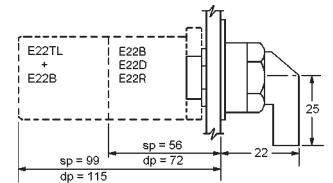

Weight 0.043kg

Notes:

14 For contact block sequences see pages 14 & 15

15 For light source units see page 8

E22 Series - Cam and contact block selection charts for selector switches

Cam and contact block selection chart – 3 way adaptor *See note 16*

Circuit configurations. Viewed from front of panel

2 position Cam II	3 position Cam I	Cam II	Contact block mounting position. Viewed from rear of panel			Contact arrangement	Catalogue number
			Left 1	Central 3	Right 2		
			■	□	□	14 —○— 13	E22B2
X 0	X 0 0	X 0 X	■	□	□	12 —○— 11	E22B1
0 X	0 X X	0 X 0	■	□	□	14 —○— 13 12 —○— 11	E22B11
0 X	X 0 0	X 0 X	■	□	□	14 —○— 13 14A —○— 13A	E22B20
0 X	0 0 X	0 0 X	□	□	■	24 —○— 23	E22B2
X 0	X X 0	X X 0	□	□	■	22 —○— 21	E22B1
0 X	0 0 X	0 0 X	□	□	■	24 —○— 23 22 —○— 21	E22B11
X 0	X X 0	X X 0	□	□	■	24 —○— 23 22 —○— 21	E22B11
0 X	0 0 X	0 0 X	□	□	■	24 —○— 23 24A —○— 23A	E22B20
0 X	X 0 0	X 0 X	■	□	■	14 —○— 13 12 —○— 11 22 —○— 21	E22B11+B1
X 0	0 X 0	0 X 0	■	□	■	14 —○— 13 12 —○— 11 22 —○— 21	E22B11+B1
0 X	0 0 X	0 0 X	■	□	■	14 —○— 13 12 —○— 11 22 —○— 21	E22B11+B1

Explanation of how to use selector switch contact block selection chart

1. Determine the "X O" sequence you require for your application.

Example:

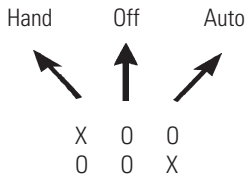

X = Circuit closed
O = Circuit open

2. Locate the first sequence "X O 0" under column marked Cam I or Cam II, then identify which Cam and contact is used and in what position it is assembled.

Example: "X O 0" uses Cam I, E22B2, mounting position 1 (left)

3. Repeat for second sequence "0 0 X". Do not mix sequences from Cam I and Cam II.

Example: "0 0 X" uses Cam I, E22B2, mounting position 2 (right)

4. Assemble contact block(s) to adaptor in the mounting position selected (two contact blocks per switch), using the selector switch with the appropriate cam and switch positions. Cam I has 1 peak, Cam II has 2 peaks, viewed from the rear.

Terminal numbers

These identify the contact block position and contact function.

Example: 14 —○— 13.

The "1" indicates mounting position number 1 (left), "3 & 4" indicates the circuit is N.O.

Note: 16 Illuminated selector switches will accommodate 1 direct voltage or 1 transformer unit with 2 contact blocks.

5 Way adaptor mounting example

Requirement	Contact status	Mounting position					Contact arrangement	Contact block catalogue number
		5-	1-	3-	2-	4-		
Hand Off Auto	X 0 0	□	■	□	□	□	14 —○— 13	E22B2
X 0 0	0 0 X	□	□	□	■	□	24 —○— 23	E22B2
X 0 0	X 0 0	■	□	□	□	□	34 —○— 33	E22B2
0 X X	X 0 0	□	□	■	□	□	54 —○— 53	E22B11
	0 X X			"			52 —○— 51	









With contact block printing facing position 2

The above example uses a 3 position selector switch cam 1 plus mounting adaptor E22BA12

Cam and contact block selection charts – 5 way adaptor

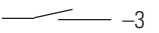
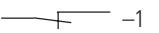
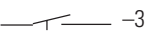

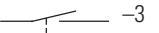





2 position selector switch operators and pushbuttons

Circuit configurations viewed from front of panel

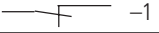
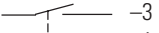
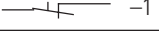
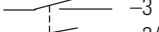
2 position cam 2 	or 	or 	or 	Contact block mounting position					Contact arrangement	Contact block catalogue number		
				5-	1-	3-	2-	4-				
0	X			■	■	■	■	■	-4		-3	E22B2
X	0			■	■	■	■	■	-2		-1	E22B1
0	X			■	■	■	■	■	-4		-3	E22B11
X	0			■	■	■	■	■	-2		-1	E22B11
0	X			■	■	■	■	■	-4		-3	E22B20
0	X			■	■	■	■	■	-4A		-3A	E22B20

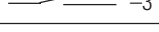
3 position selector switch operators

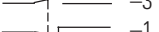
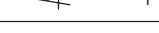
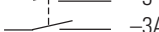
Circuit configurations viewed from front of panel

3 position cam 1 	3 position cam 2 	Contact block mounting position					Contact arrangement	Contact block catalogue number				
		5-	1-	3-	2-	4-						
X	0	0	Not suitable	■	■	□ A	□	□	-4		-3	E22B2
0	X	X	"	■	■	□ A	□	□	-2		-1	E22B1
X	0	0	"	■	■	□ A	□	□	-4		-3	E22B11
0	X	X	"	■	■	□ A	□	□	-2		-1	E22B11
X	0	0	"	■	■	□ A	□	□	-4		-3	E22B20
X	0	0	"	■	■	□ A	□	□	-4A		-3A	E22B20
0	0	X	"	□	□	□ B	■	■	-4		-3	E22B2
X	X	0	"	□	□	□ B	■	■	-2		-1	E22B1
0	0	X	"	□	□	□ B	■	■	-4		-3	E22B11
X	X	0	"	□	□	□ B	■	■	-2		-1	E22B11
0	0	X	"	□	□	□ B	■	■	-4		-3	E22B20
0	0	X	"	□	□	□ B	■	■	-4A		-3A	E22B20

□ A. Operated as positions 1 & 5 with contact block printing facing position 2. □ B. Operated as positions 2 & 4 with contact block printing facing position 1.

Applications

Use any combination of contact blocks/light source except where noted

Front of panel device	5 way adaptor/back of panel options				Front of panel device	5 way adaptor/back of panel options			
	Non ill operators		Ill operators			Non ill operators		Ill operators	
	E22BA11	BA12	E22BA11L	BA12L		E22BA11	BA12	E22BA11L	BA12L
Flush & extended pushbuttons	Yes	No	Yes	No	29.5 and 40mm 3 position push pull	No	No	No	No
28, 40, 50mm mushroom (momentary)	Yes	No	No	No	Double headed pushbutton	No	No	No	No
50mm mushroom latch (pull to release)	Yes	No	Yes	No	2 position selector switch cam 2	Yes	No	Yes	No
40mm mushroom latch (key release)	Yes †	No	No	No	3 position selector switch cam 1	No	Yes	No	Yes
28 & 40mm mushroom latch (twist to release)	Yes †	No	No	No	3 position selector switch cam 2	No	No	No	No
29.5 and 40mm 2 position push pull	Yes	No	Yes	No	† 4 single circuit contact blocks maximum				

Notes:

E22B4 & E22BF4 can not be used with 5 way adaptors.

5 way adaptors can only be used in single way double contact block depth enclosures.

E22 Series - Complete rotary cam selector switches

Complete rotary cam selector switches *See notes 17 & 18*



Lever operator

Knob operator

Key operator

Description, circuit and terminal numbers	Contact sequence	Switch position	Operator type	Catalogue numbers Chrome bezel	Black bezel
4 Position 2 —○— 1 6 —○— 5 4 —○— 3 8 —○— 7	1 2 3 4 X 0 0 0 0 X 0 0 0 0 X 0 0 0 0 X		Lever Knob Key	E22JD4W1 E22LD4W1 E22KD4W8	E22JDB4W1 E22LDB4W1 E22KDB4W8
5 Position 2 —○— 1 8 —○— 7 10 —○— 9 6 —○— 5 4 —○— 3	1 2 3 4 5 X 0 0 0 0 0 X 0 0 0 0 0 X 0 0 0 0 0 X 0 0 0 0 0 X		Lever Knob Key	E22JD5W1 E22LD5W1 E22KD5W8	E22JDB5W1 E22LDB5W1 E22KDB5W8
6 Position 2 —○— 1 6 —○— 5 10 —○— 9 12 —○— 11 4 —○— 3 8 —○— 7	1 2 3 4 5 6 X 0 0 0 0 0 0 X 0 0 0 0 0 0 X 0 0 0 0 0 0 X 0 0 0 0 0 0 X 0 0 0 0 0 0 X		Lever Knob Key	E22JD6W1 E22LD6W1 E22KD6W8	E22JDB6W1 E22LDB6W1 E22KDB6W8
7 Position 2 —○— 1 6 —○— 5 10 —○— 9 14 —○— 13 4 —○— 3 8 —○— 7 12 —○— 11	1 2 3 4 5 6 7 X 0 0 0 0 0 0 0 X 0 0 0 0 0 0 0 X 0 0 0 0 0 0 0 X 0 0 0 0 0 0 0 X 0 0 0 0 0 0 0 X 0 0 0 0 0 0 0 X		Lever Knob Key	E22JD7W E22LD7W1 E22KD7W8	E22JDB7W1 E22LDB7W1 E22KDB7W8
8 Position 2 —○— 1 6 —○— 5 10 —○— 9 14 —○— 13 4 —○— 3 8 —○— 7 12 —○— 11 16 —○— 15	1 2 3 4 5 6 7 8 X 0 0 0 0 0 0 0 0 X 0 0 0 0 0 0 0 0 X 0 0 0 0 0 0 0 0 X 0 0 0 0 0 0 0 0 X 0 0 0 0 0 0 0 0 X 0 0 0 0 0 0 0 0 X 0 0 0 0 0 0 0 0 X		Lever Knob Key	E22JD8W1 E22LD8W1 E22KD8W8	E22JDB8W1 E22LDB8W1 E22KDB8W8

Complete rotary cam selector switches *See notes 17 & 18*

Description, circuit and terminal numbers	Contact sequence	Switch position	Operator type	Catalogue numbers Chrome bezel	Black bezel
4 Position 2 — 1 6 — 5 4 — 3	0 1 2 3 0 X 0 0 0 0 X 0 0 0 0 X		Lever Knob Key	E22JD4Y1 E22LD4Y1 E22KD4Y8	E22JDB4Y1 E22LDB4Y1 E22KDB4Y8
5 Position 2 — 1 6 — 5 4 — 3 8 — 7	0 1 2 3 4 0 X 0 0 0 0 0 X 0 0 0 0 0 X 0 0 0 0 0 X		Lever Knob Key	E22JD5Y1 E22LD5Y1 E22KD5Y8	E22JDB5Y1 E22LDB5Y1 E22KDB5Y8
6 Position 2 — 1 6 — 5 8 — 7 10 — 9 4 — 3	0 1 2 3 4 5 0 X 0 0 0 0 0 0 X 0 0 0 0 0 0 X 0 0 0 0 0 0 X 0 0 0 0 0 0 X		Lever Knob Key	E22JD6Y1 E22LD6Y1 E22KD6Y8	E22JDB6Y1 E22LDB6Y1 E22KDB6Y8
7 Position 2 — 1 6 — 5 10 — 9 12 — 11 4 — 3 8 — 7	0 1 2 3 4 5 6 0 X 0 0 0 0 0 0 0 X 0 0 0 0 0 0 0 X 0 0 0 0 0 0 0 X 0 0 0 0 0 0 0 X 0 0 0 0 0 0 0 X		Lever Knob Key	E22JD7Y1 E22LD7Y1 E22KD7Y8	E22JDB7Y1 E22LDB7Y1 E22KDB7Y8
8 Position 2 — 1 6 — 5 10 — 9 14 — 13 4 — 3 8 — 7 12 — 11	0 1 2 3 4 5 6 7 0 X 0 0 0 0 0 0 0 0 X 0 0 0 0 0 0 0 0 X 0 0 0 0 0 0 0 0 X 0 0 0 0 0 0 0 0 X 0 0 0 0 0 0 0 0 X 0 0 0 0 0 0 0 0 X		Lever Knob Key	E22JD8Y1 E22LD8Y1 E22KD8Y8	E22JDB8Y1 E22LDB8Y1 E22KDB8Y8

Dimensions (mm)

Lever operator

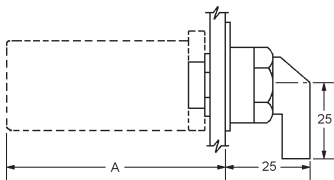

Knob operator

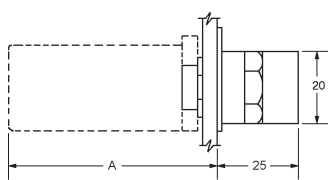

Key operator

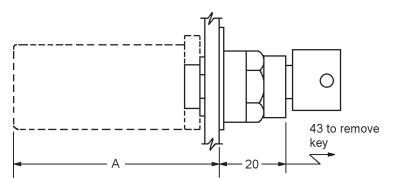

No. of circuits	Dim. A
1 - 2	72mm
3 - 4	84mm
5 - 6	96mm
7 - 8	108mm

Notes:

17 Lever and knob switches are fitted with black operators.

18 Key switches are fitted with standard lock key ref. 92239 with the key removable in all positions. For a non-standard lock refer to Eaton.

E22 Series - Complete rotary cam selector switches

Complete rotary cam selector switches *See notes 17 & 18*

















Lever operator



Knob operator



Key operator

Description terminal numbers	Circuit and sequence	Contact of poles	Number type	Operator Chrome bezel	Catalogue numbers	
					Black bezel	
2 Position changeover 	 Pole 1	XO OX	1	Lever Knob Key	E22JDP1 E22LDP1 E22KDP5	E22JDBP1 E22LDBP1 E22KDBP5
	 Pole 2	XO OX	2	Lever Knob Key	E22JDR1 E22LDR1 E22KDR5	E22JDBR1 E22LDBR1 E22KDBR5
	 Pole 3	XO OX	3	Lever Knob Key	E22JDS1 E22LDS1 E22KDS5	E22JDBS1 E22LDBS1 E22KDBS5
	 Pole 4	XO OX	4	Lever Knob Key	E22JDT1 E22LDT1 E22KDT5	E22JDBT1 E22LDBT1 E22KDBT5
2 Position changeover 	 Pole 1	XO OX	1	Lever Knob Key	E22JDP51 E22LDP51 E22KDP53	E22JDBP51 E22LDBP51 E22KDBP53
	 Pole 2	XO OX	2	Lever Knob Key	E22JDR51 E22LDR51 E22KDR53	E22JDBR51 E22LDBR51 E22KDBR53
	 Pole 3	XO OX	3	Lever Knob Key	E22JDS51 E22LDS51 E22KDS53	E22JDBS51 E22LDBS51 E22KDBS53
	 Pole 4	XO OX	4	Lever Knob Key	E22JDT51 E22LDT51 E22KDT53	E22JDBT51 E22LDBT51 E22KDBT53
3 Position without off	 Pole 1	XO0 OX0 OOX	2	Lever Knob Key	E22JDV1 E22LDV1 E22KDV7	E22JDBV1 E22LDBV1 E22KDBV7
	 Pole 2	XO0 OX0 OOX				
	 Pole 3	XO0 OX0 OOX	3	Lever Knob Key	E22JDW1 E22LDW1 E22KDW7	E22JDBW1 E22LDBW1 E22KDBW7
3 Position with centre position off	 Pole 1	XO0 OX0 OOX				
	 Pole 2	XO0 OX0 OOX				
	 Pole 3	XO0 OX0 OOX				

Switching angles



Overall dimensions. See page 19

E22 Series - Ammeter and voltmeter rotary cam selector switches

Complete rotary cam selector switches See notes 17 & 18

Description	Circuit and terminal numbers	Contact sequence	Number of poles	Operator type	Catalogue numbers Chrome bezel	Black bezel
3 Position with right hand position off	2 — 1 4 — 3	Pole 1 X00 OXO	2	Lever Knob Key	E22JDL1 E22LDL1 E22KDL7	E22JDBL1 E22LDBL1 E22KDBL7
	6 — 5 8 — 7					
3 Position with left hand position off	2 — 1 4 — 3	Pole 1 OXO OOX	2	Lever Knob Key	E22JDM1 E22LDM1 E22KDM7	E22JDBM1 E22LDBM1 E22KDBM7
	6 — 5 8 — 7					
4 Position without off	2 — 1 6 — 5 8 — 7 4 — 3	Pole 1 X000 OX00 00X0 000X	1	Lever Knob	E22JDN1 E22LDN1	E22JDBN1 E22LDBN1

Ammeter and voltmeter rotary cam selector switches

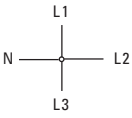
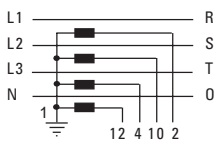
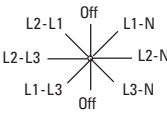
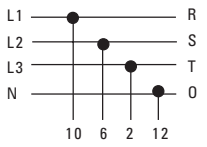
Description	Switch positions	Circuit and terminal numbers	Operator type	Catalogue numbers Chrome bezel	Black bezel
Ammeter switch (Single pole 4 current transformers)			1 — 5 Lever Knob	E22JDAM1 E22LDAM1	E22JDBAM1 E22LDBAM1
Voltmeter switch (3 Phase to phase and 3 phase to neutral)			1 — 3 Lever Knob	E22JDVM1 E22LDVM1	E22JDBVM1 E22LDBVM1

Dimensions (mm)

Lever operator

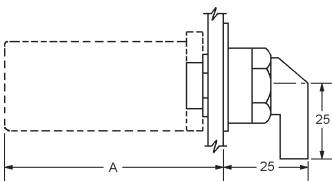

Knob operator

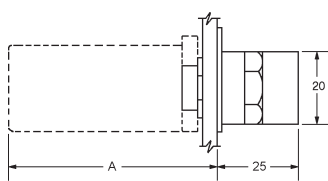

Key operator

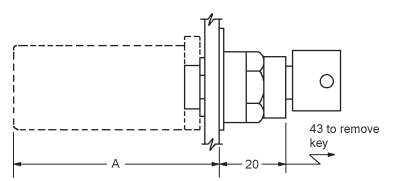

No. of circuits	Dim. A
1 — 2	72mm
3 — 4	84mm
5 — 6	96mm
7 — 8	108mm

Notes:

17 Lever and knob switches are fitted with black operators.

18 Key switches are fitted with standard lock key ref. 92239 with the key removable in all positions. For a non-standard lock refer to Eaton.

E22 Series - Legend plates

Legend plates

Description	Size (mm)	Catalogue numbers
Aluminium (IP65)	30 x 45 40 x 45	E22NE* E22NF*



Description	Size (mm)	Catalogue numbers
Enclosure legend plate (Adhesive backing)	19 x 19	E22NC*



Description	Size (mm)	Catalogue numbers
Clip-in legend (IP65)	30 x 45 40 x 45	Legend carrier Legend plate E22ND E22ND* Legend carrier Legend plate E22PD E22PD*

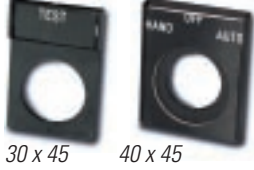

Special engraving

Where non-standard engraving is required the maximum number of letters (including spaces) 3mm high that can be engraved per row is as follows:

E22ND	2 rows, 8 letters
E22NE	3 rows, 8 letters
E22NF	3 rows, 11 letters
E22PD	2 rows, 11 letters

* Add relevant suffix code from list below for required legend. Example E22NE11 = aluminium legend plate engraved "close".

Legend	Code number	Legend	Code number	Legend	Code number	Legend	Code number
(Blank)	36	Inch reverse	59	Off On (19)	42	Slow	32
(Blank†)	37	Inch Run (19)	60	Off On (20)	105	Slower	88
Auto Off Hand	49	Inch Run (20)	114	On	25	Start	33
Clamp	90	Jog	19	Open	26	Start Inch (19)	77
Close	11	Jog for	96	Open Close (19)	43	Start Inch (20)	119
Down	12	Jog rev	21	Open Close (20)	106	Start Stop (19)	47
Emerg stop†	13	Left	10	Open Off Close	53	Start Stop (20)	110
Fast	14	Left Right (19)	66	Out	27	Stop†	34
For	4	Left Right (20)	117	Overload tripped	98	Stop reset†	58
Forward	15	Loc Rem (19)	63	Overload reset	100	Supply on	61
For Off Rev	50	Loc Rem (20)	116	Power on	80	Test	83
For Rev (19)	38	Low	22	Raise	28	Trip	84
For Rev (20)	101	Lower	23	Ready	86	Unclamp	91
Hand Auto (19)	39	Man Auto (19)	67	Reset	29	Up Down (19)	48
Hand Auto (20)	102	Man Auto (20)	118	Rev	6	Up Down (20)	111
Hand Off Auto	51	Man Off Auto	68	Reverse	30	Up	35
High	16	Motor run	81	Right	79	Special legend	36x
High Low (19)	40	Motor running	56	Run	31	Special legend†	37x
High Low (20)	103	Motor stop	82	Seq. Test (19)	62	Quote legend required.	
I	65	Motor stopped	57	Seq. Test (20)	115		
I O II	121	O†	64				
In	17	O I (19)	122				
Inch	18	O I (20)	120				
Inch forward	76	Off†	24				

Notes: (19) For selector switches with left/right switch angle.
(20) For selector switches with centre/right switch angle.

† The standard colour field is black except those marked with a dagger which are red.

Push-Pull legend plates aluminium IP65 rated

Legend	Catalogue number
Pull on, Push off	E22NP73
Pull open, Push close	E22NP74
Pull start, Push stop	E22NP75
Pull up, Push down	E22NP76
Blank	E22NP77

Visual aid plate

Description	Catalogue number
 70mm not printed	E22VA1
45mm not printed	E22VA2
70mm printed "EMERGENCY STOP"	E22VA8

Legend plates for 4 – 8 position selector switches

Description

Catalogue numbers

Legend plates with standard text
 Size 45 x 45mm (E22NJP*)
 60 x 60mm (E22NGP*)
 Black background, white letters.

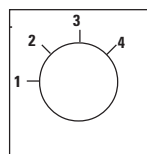

E22NJP215

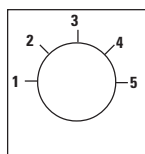

E22NJP216

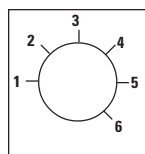

E22NJP217

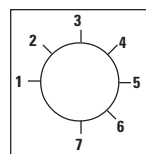

E22NJP218

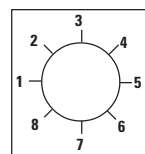

E22NJP219

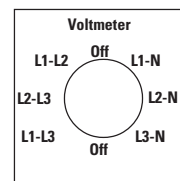

E22NGP220

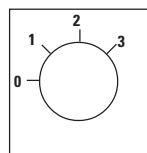

E22NJP210

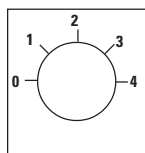

E22NJP211

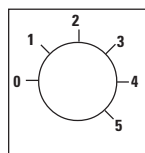

E22NJP212

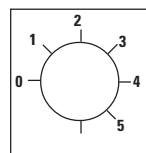

E22NJP213

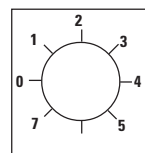

E22NJP214

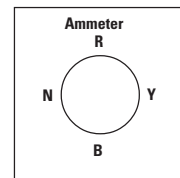

E22NGP221

Description

Size (mm)

Catalogue numbers

Legend plates without text
 Black onside, red reverse.
 White text





45 x 45
 60 x 60

E22NJP36
E22NGP36

Non-standard legends

If a legend is required that is not listed above, specify the blank catalogue number for the required size, add a suffix 'X' and detail engraving requirements. Use dashes to separate positions and quote background colour (black or red).
 Example: E22NJP36X, OFF – PUMP 1 – PUMP 2 – PUMP 3 – PUMP 4, black background.

Accessories







	Description		Catalogue number
	Locating rings Gives additional anti-rotational feature. Panel notch required.	Pack of 10	E22LRP
	Operator plug To operate centre contact block on pushbuttons and momentary mushroom operators.		E22BA2
	Moulded black bezels For converting chrome type to moulded plastic.	For 25mm pushbuttons.	E22AYB
		For knob, lever, key selector switches	E22AZB
	Push-on terminals To convert screw type terminal devices. Rated 300V maximum.	Pack of 10	E22AT
	Five way mounting adaptor For use with:	Non-illuminating operators and mushroom operators	E22BA11
		Illuminated pushbuttons and mushroom operators	E22BA11L
		Non-illuminating key, lever and knob type selector switches	E22BA12
		Illuminated lever and knob type selector switches	E22BA12L







E22 Series - Accessories



Accessories



	Description numbers	Catalogue dimensions (mm)	Overall (kg)	Weight
	Padlockable transparent cover. For flush & extended 25mm pushbuttons. For extended 25mm pushbuttons. Enables N.C. circuit to be held open when in padlocked position.	E22PCM		0.025
	Padlockable transparent cover. For use with 28mm mushroom operators, knob and key selector switches.	E22BA9		0.025
	Mechanical push. For use with pushbuttons and push-pulls only. Cut to required length. Pushbutton stroke 5.8mm.	E22MRL		
	Protective boot Forms oil and watertight seal to IP66. For flush & extended pushbuttons only	Red Green Black Clear	E22BRM E22BGM E22BBM E22BCM	0.015 0.015 0.015 0.015
	Mushroom shroud Protects against inadvertent operation. Suitable for all operators up to 40mm dia.	Half shroud Full shroud	E22MS E22MSF	0.05 0.05
	Hole plug Forms oil and watertight seal (IP66) for unused panel hole.	Plastic Stainless steel	E22BHP E22BA8	0.015 0.03
	Bulb removal tool. To assist bulb removal on illuminated operators from front of panel		E22BA3	
	Handtool For cutting 22.5mm diameter hole Maximum sheet steel panel thickness 1.6mm		E22BA5	
	Octagonal box spanner. Ensures easy tightening of rear of panel mounting rigs on all operators.		E22BA6	
	Bulb extender For use with BA9s bayonet base bulbs. For use with illuminated selector and push-pull switches.		E22BA4	
	Hole Reducer Converts 30.5 mm hole in diecast enclosures to 22.5 mm		E22BA14	

Accessories (continued)

Description	Colour	Catalogue numbers		Selector switch Levers		Selector switch Knobs	
		Push-pull cap 29.5mm	40mm				
Replacement caps, levers and knobs – Non-illuminated  Caps  Levers  Knobs	Black	E22AHS1	E22AH1	E22AV1	E22AV21	E22AX1	E22AX21
	Red	E22AHS2	E22AH2	E22AV2	E22AV22	E22AX2	E22AX22
	Green	E22AHS3	E22AH3	E22AV3	E22AV23	E22AX3	E22AX23
	Yellow	E22AHS4	E22AH4	E22AV4	E22AV24	E22AX4	E22AX24
	White	E22AHS5	E22AH5	E22AV5	E22AV25	E22AX5	E22AX25
	Blue	E22AHS6	E22AH6	E22AV6	E22AV26	E22AX6	E22AX26
	Grey	E22AHS7	E22AH7	E22AV7	E22AV27	E22AX7	E22AX27
	Orange	E22AHS8	E22AH8	E22AV8	E22AV28	E22AX8	E22AX28
	Red marked EMERGENCY STOP	–	E22AH2N8	–	–	–	–

Description	Colour	Catalogue numbers		Selector switch Levers		Selector switch Knobs	
		Push-pull cap 29.5mm	40mm				
Illuminated  Caps  Levers  Knobs	Clear	E22AFS0	E22AF0	E22AW0	E22AW20	E22AR0	E22AR20
	Red	E22AFS2	E22AF2	E22AW2	E22AW22	E22AR2	E22AR22
	Green	E22AFS3	E22AF3	E22AW3	E22AW23	E22AR3	E22AR23
	Yellow	E22AFS4	E22AF4	E22AW4	E22AW24	E22AR4	E22AR24
	White	E22AFS5	E22AF5	E22AW5	E22AW25	E22AR5	E22AR25
	Blue	E22AFS6	E22AF6	E22AW6	E22AW26	E22AR6	E22AR26
	Amber	E22AFS9	E22AF9	E22AW9	E22AW29	E22AR9	E22AR29
	Red marked EMERGENCY STOP	–	E22AF2N8	–	–	–	–

Description	Colour	Catalogue numbers		Glass lens	Lens for double pushbutton
		Standard lens	Lens for printed insert*		
Replacement lenses – indicating lights  Standard lens  Glass lens	Clear	E22AE0	E22AG0	E22AC0	E22AE20
	Red	E22AE2	E22AG2	E22AC2	E22AE22
	Green	E22AE3	E22AG3	E22AC3	E22AE23
	Yellow	E22AE4	E22AG4	–	–
	White	E22AE5	E22AG5	E22AC5	E22AE25
	Blue	E22AE6	E22AG6	E22AC6	E22AE26
	Amber	E22AE9	E22AG9	E22AC9	E22AE29

Description	Ref. no.	Catalogue numbers	* Printed insert	Catalogue no.	* Printed insert	Catalogue no.
			 Lens for printed insert	 Printed insert		Without marking
			Motor run	E22AL5N81	Power on	E22AL5N80
			Motor running	E22AL5N56	Supply on	E22AL5N61
			Motor stopped	E22AL5N57	Special legend	E22AL5N36X
			Off	E22AL5N24		

Spare keys

Description	Ref. no.	Catalogue numbers
2 Standard keys	92239	E22KS2
1 Master key (For all non-standard locks)	92	E22KM92







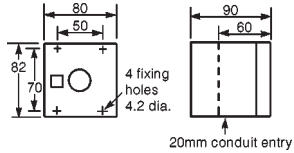

For spare keys of locks not listed please contact Eaton

E22 Series - Enclosures - polycarbonate

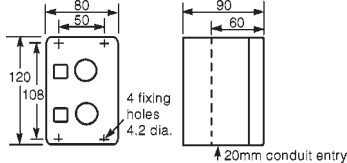
Enclosures – polycarbonate

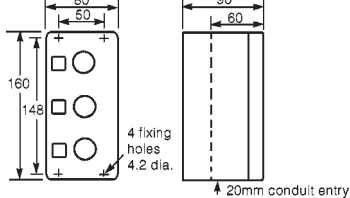
Main features

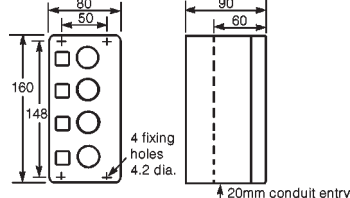

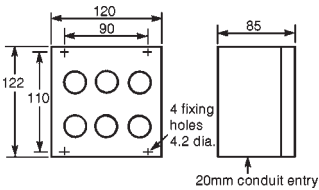

- Polycarbonate enclosures
- IP65 ingress protection
- Quick release stainless steel screws
- Double insulated
- Colour light grey

	Description	Usable depth	Catalogue numbers	Weight (kg)	Overall dimensions (mm)
	Single way Grey base and grey lid	56mm	E22CSP1	0.1	
	Grey base and yellow lid	86mm	E22CDP1	0.1	
	Two way Mounting matrix 36mm	56mm	E22CSP2	0.2	
		86mm	E22CDP2	0.4	
	Three way Mounting matrix 36mm	56mm	E22CSP3	0.2	
		86mm	E22CDP3	0.4	
	Four way Mounting matrix 30mm	56mm	E22CSP4	0.2	
		86mm	E22CDP4	0.4	
	Six way Mounting matrix 36mm x 47mm	81mm	E22CDP6	0.6	

Enclosures – die cast aluminium

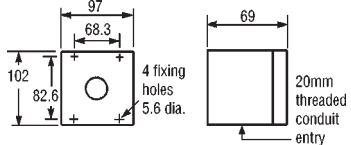

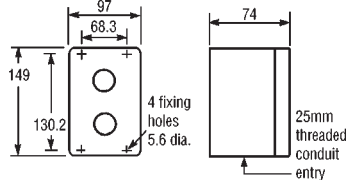

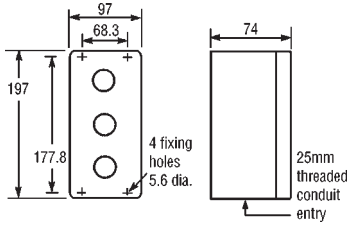





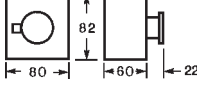
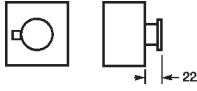
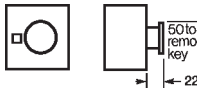
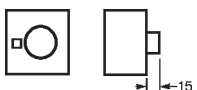
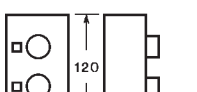

Main features

- Powder coated paint finish
- IP65 ingress protection
- Threaded conduit entry
- Colour light grey RAL 7032

	Description	Usable depth	Catalogue numbers	Weight (kg)	Overall dimensions (mm)
	Single way Grey base and grey lid	50mm	E22CDD1	0.05	
	Grey base and yellow lid	50mm	E22CDD1Y	0.05	
	Two way Mounting matrix 47mm	50mm	E22CDD2	0.65	
	Three way Mounting matrix 47mm	50mm	E22CDD3	0.76	

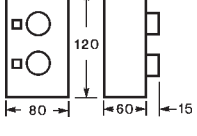
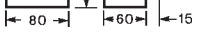
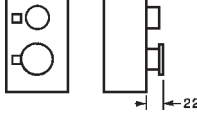
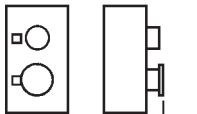
E22 Series - Assembled stations

Assembled stations

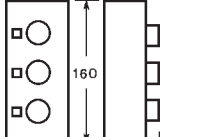
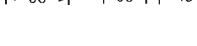
Description	Operator	Button colour	Contact arrangement	Catalogue numbers		Operator dimensions (mm)	Weight (kg)
				Chrome bezel	Black bezel		
Single way     	40 mm mushroom	Red (spring return)	N.C. Yellow background	E22AS105	E22ASB105		0.2
	40 mm mushroom	Red (latch-in twist to release)	N.C. Yellow background	E22AS106	E22ASB106		0.2
	40 mm mushroom (latch-in key release) Yellow background (IP54)	Red	N.C.	E22AS107	E22ASB107		0.23
	Start (flush)	Green with legend	N.O.	E22AS108	E22ASB108		0.2
	Stop (extended)	Red with legend	N.C.	E22AS109	E22ASB109		0.2
Two way   	Start (flush) Stop (extended)	Green Red	N.O. N.C.	E22AS204	E22ASB204		0.32
	▲ (flush) ▼ (flush)	Black Black	N.O. N.O.	E22AS207	E22ASB207		0.32
	Start (flush) Stop (40 mm mushroom spring return)	Green Red	N.O. N.C.	E22AS205	E22ASB205		0.32
	Start (flush) Stop (40 mm mushroom latch-in twist to release)	Green Red	N.O. N.C.	E22AS206	E22ASB206		0.37
	Three way    	Forward (flush) Stop (extended) Reverse (flush)	Black Red Black	N.O. N.C. N.O.	E22AS304	E22ASB304	
Open (flush) Stop (extended) Close (flush)		Black Red Black	N.O. N.C. N.O.	E22AS305	E22ASB305		0.5
Up (flush) Stop (extended) Down (flush)		Black Red Black	N.O. N.C. N.O.	E22AS306	E22ASB306		0.5
▲ (flush) ○ (extended) ▼ (flush)		Black Red Black	N.O. N.C. N.O.	E22AS307	E22ASB307		0.5

Technical data

Operator forces

Operation		Initial force (N)	Final force (N)
Pushbutton	25mm	2.25	5.6
	Mushroom	3	6.9
2 Position push/pull		16	0
3 Position push/pull	Push	0	22.3
	Pull	0	33.5
Single circuit contact block	E22B2 N.O. contact block	1	4.45
	E22B1 N.C. contact block	0.3	3.4
Dual circuit contact blocks	E22B20 2N.O. contact block	0.8	5.9
	E22B11 1N.O. + 1N.C contact block	0.6	5.4

Operator torque

Operation		Initial torque (Nm)	Final torque (Nm)
Key, lever & knob selectors	Spring return	0.1	0.15
	Maintained	0.2	0.3

Mounting (mm)

Description	Dimension	
Mounting panel thickness – minimum	1	
	– maximum	6.35*
* The accessories alongside reduce the maximum panel thickness by the following amount.	Legend plates	1.25
	Locating ring	1.5
	Padlockable cover	2.4
	Rubber boots	1.3

Optional panel notch to provide anti-rotation. Use E22LRP or E22LRM accessory

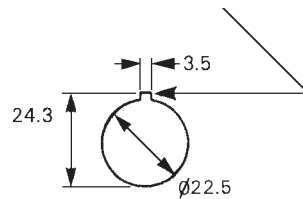

Mounting matrix – minimum (mm)

Description	3 Way mounting adaptor		5 Way mounting adaptor		
	Dim 'A'	Dim 'B'	Dim 'A' (1)	Dim 'A' (2)	Dim 'B'
All operators except those below	30	50	40	50	50
3 Position lever selector switches & 40mm operators	45	50	45	50	50
50mm operators	55	55	55	55	55
Pushbuttons assembled with boots or padlockable covers	35	50	40	50	50

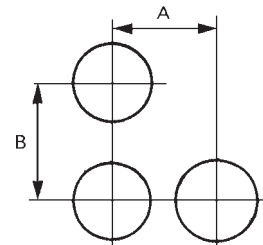

A (1) Horizontal spacing for one 3 way & one 5 way mounting adaptor.

A (2) Horizontal spacing for two 5 way mounting adaptors.

AC15 Electrical durability

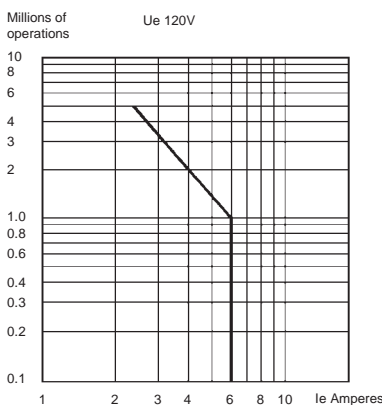

DC13 Electrical durability

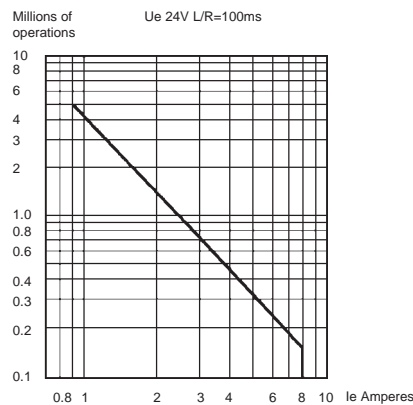

DC13 Electrical durability

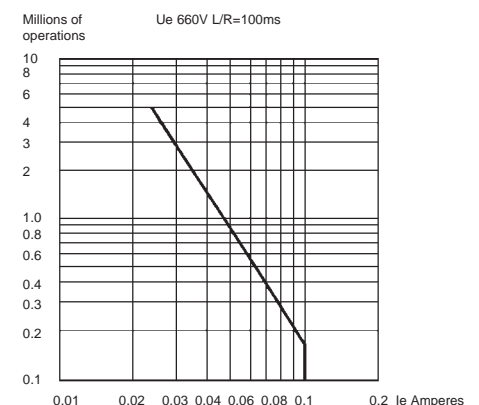

E22 Series - Technical data

Technical data

	Contact blocks	Pushbutton operators	Push/pull operators	Double headed operators
General				
Standards and approvals	IEC947-5-1, IEC337-1, BS4794, VDE0660, UL508, CSA22.2 no. 14, Lloyds			
Terminal markings	EN50013 (BS5581)	–	–	–
Ingress protection – IEC529*	–	IP65	1P65	–
– UL508 (NEMA)*	–	Type 4, 4x, 13	Type 4, 4x, 13	–
Protection against direct contact IEC529	IP20	–	–	–
Mechanical life span (no. of operations)	3,000,000	5,000,000	300,000	1,000,000
Operating frequency (operations per hour)	6,000	6,000	3,000	6,000
Weight	13g (single) 22g (double)	43g	32g	26g
Environment				
Pollution degree IEC947-1	3	3	3	3
Impulse withstand voltage IEC947-1	4kV	4kV	4kV	4kV
Operating ambient temperature – non-illuminated	–20 to +60°C	–20 to +60°C	–20 to +60°C	–20 to +60°C
– illuminated	–	–20 to +60°C	–20 to +60°C	–20 to +60°C
Vibration resistance 10 sweeps 10 - 500Hz		5g	5g	5g –
Shock resistance (shock duration 18ms)		30g	30g	30g –
Bump resistance 6ms 1000cycles	25g	25g	25g	–
Storage temperature	–40 to +80°C	–40 to +80°C	–40 to +80°C	–40 to +80°C
Mounting position	Any	Any	Any	Any
Operating altitude	2000m	2000m	2000m	2000m
Cabling capacity				
Number of conductors	2	–	–	–
Solid, stranded or flexible – Max wire size (mm ²)	2.5	–	–	–
– Min wire size (mm ²)	0.75	–	–	–

* Ingress protection provided by E22 component fitted to a suitable enclosure.

Contact ratings – Contact blocks

Thermal current I _{th}	10A
Insulation voltage U _i	690V
Operating frequency limits	50 to 60Hz
Adjacent contacts 'electrically separate'	Yes

AC15 duty (AC11 to IEC337)	U _e	VA	I _e
Control of A.C. electromagnetic loads	48V	480	10A
	120V	720	6A
	240V	960	4A
	440V	880	2A
	660V	990	1.5A

DC13 duty (DC11 to IEC337)	U _e	W	I _e
Control of D.C. electromagnets	24V	192	8A
	48V	288	6A
	120V	120	1A
	220V	110	0.5A
	440V	110	0.25A
	660V	66	0.1A

Short circuit co-ordination

Conditional short circuit current I _g	1kA
Fuse type BS88 type gG	10A

UL and CSA ratings

Maximum rated voltage	600Vac
Switching capacity	
– Heavy pilot duty (A600)	6A ac
– Heavy pilot duty (Q600)	0.55A dc

Contact operation

Normally open (N.O.)	Slow make, break
Normally closed (N.C.)	Slow make break, positive action

Low power switching

(Operating under normal environmental conditions)	
Minimum operational voltage (ac/dc)	5V
Minimum operational current (ac/dc)	1mA

E22 Series - Technical data

Mushroom operators	Selector switch operators	Rotary cam selector switches	Transformer light source units	Non-transformer light source units	Indicating lights	Monoblock indicating lights
IEC947-5-1, IEC337-1, BS4794, VDE0660, UL508, CSA22.2 no 14, Lloyds						IEC337-1
–	–	EN50013 (BS5581)	EN50013 (BS5581)	EN50013 (BS5581)	EN50013 (BS5581)	EN50013 (BS5581)
IP65	IP65	IP65	–	–	IP65	–
Type 4, 4x, 13	Type 4, 4x, 13	Type 4, 4x, 13	–	–	Type 4, 4x, 13	–
–	–	–	IP20	IP20	–	IP10
300,000	500,000	2,000,000	–	–	–	–
1,200	3,000	3,000	–	–	–	–
70g	55g (key) 43g (lever)	106g (4 circuit) 115g (6 circuit) 125g (8 circuit)	80g	14g	23g	21g
3	3	3	3	3	3	3
4kV	4kV	4kV	4kV	4kV	4kV	4kV
–20 to +60°C	–20 to +60°C	–20 to +60°C	–	–	–	–
–20 to +60°C	–20 to +60°C	–	–20 to +60°C	–20 to +60°C	–20 to +60°C	–20 to +60°C
5g	5g	–	5g	5g	5g	–
30g	30g	30g†	30g	30g	30g	–
25g	25g	25g†	25g	25g	25g	–
–40 to +80°C	–40 to +80°C	–40 to +80°C	–40 to +80°C	–40 to +80°C	–40 to +80°C	–40 to +80°C
Any	Any	Any	Any	Any	Any	Any
2000m	2000m	2000m	2000m	2000m	2000m	2000m
–	–	2	2	2	–	2
–	–	1.5	2.5	2.5	–	2.5
–	–	0.75	0.75	0.75	–	0.75

† Rotary cam selector switches having no more than 4 circuits.

Contact ratings – Rotary cam switches

Thermal current I _{th}	10A		
Insulation voltage U _i	500V		
Operating frequency limits	50-60Hz		
Adjacent contacts 'electrically separate'	Yes		
AC1 duty	U _e	VA	I _e
Resistive or low inductive loads	380V	3,800	10A
AC11 duty			
Control of A.C. electromagnets	240V 440V	600 660	2.5A 1.5A
AC21 duty			
Switching of resistive loads, including moderate overloads	500V	5,000	10A
AC22 duty			
Switching of combined resistive or inductive loads, including moderate overloads	500V	5,000	10A
Short circuit co-ordination			
Conditional short circuit current I _g	3kA		
Fuse type BS88 type gG	10A		
Circuit breaker type	To be announced		

DC switching capacity

Number of series contacts	Voltage (V)								Amperes
	1	2	3	4	5	6	8		
DC1 resistive loads	24	48	70	95	120	144	190	10	
	48	95	140	190	240	290	350	6	
L/R<=1ms	60	120	180	240	300	360	450	2.5	
	110	220	330	440	–	–	–	0.7	
	220	440	–	–	–	–	–	0.3	
	440	–	–	–	–	–	–	0.2	
DC1 inductive loads	24	48	72	96	120	144	190	6	
	30	60	90	120	150	180	240	3	
L/R<=50ms	48	95	140	190	240	290	350	1	
	60	120	180	240	300	360	450	0.7	
	110	220	330	440	–	–	–	0.3	

UL & CSA ratings

Maximum rated voltage	300V ac
Switching capacity, heavy pilot duty A300	3A ac
DOL motor load	3 phase 240V 1HP 1 phase 120V 0.33HP 240V 0.75HP

E22 Series - Technical data

Technical data – Trigger action actuators

Description

The E22LTA2 is a latching, trigger-action, twist-to-release pushbutton actuator designed specifically for use as an Emergency Stop Switch.

The E22MGTA is a rectangular guard designed to prevent accidental or inadvertent actuation of the E22TLA actuator. It is also designed to permit easy knob rotation access for manually resetting the switch.

The E22CB1, E22CB11 & E22CB1E contact blocks are specially marked contact blocks indicating compliance with IEC 60947-5-1 Annex K.

Application

The E22LTA2 actuator and E22CB* contact blocks are intended to be the primary and/or one of several series-connected emergency stop switches in a control panel. The N.C. (normally closed), break electrical contacts are D.O.A. (direct opening action) which are designed to be forcibly opened by the movement of the actuator in the event that the contact should be tack welded etc.

Key features

- ★ Mushroom head button (40mm diameter) for easy actuation (per EN418 Section 4.4).
- ★ Safety red coloured button per ANSI Z535.1 and EN418 Section 4.4.3.
- ★ Manually resettable actuator.
- ★ Rectangular guard is coloured safety yellow per ANSI Z535.1 and provides yellow background for the actuator per EN418 Section 4.4.3.
- ★ All external pushbutton and guard materials have a V-0 flammability rating per UL94.
- ★ Contact blocks are A600/Q600 rated per UL508 and AC15/DC13 rated per IEC 60947-5-1.
- N.C. (normally closed), break contact blocks are positive opening or D.O.A. (direct opening action) in accordance with EN418 Section 4.1.2.
- ★ Suitable for isolation per IEC 60947-5-1.

Environmental ratings (actuator)**Ingress protection**

UL (NEMA) 1, 2, 3, 3R, 4, 4X, 12 & 13 and IEC IP 65 when mounted on a flat surface of a similarly rated enclosure. Above ratings do not apply to applications where devices are mounted directly onto a machine without the use of a separate console or enclosure. If not installed in a suitable panel or enclosure, precautions must be taken to safeguard contact blocks against electrical contact or shock and from contamination from environmental or working conditions of the machine.

Operating temperature

–20° to +60°C

Storage temperature

–40° to +80°C

Altitude

2,000m

Humidity

Max 95% RH @ 60°C

Flammability

UL94 V-0 rated

UV resistance

Shield actuator from excessive exposure to UV, and routinely perform a functional test of the emergency stop switch and inspect actuator for fading and cracking after every 500 hours of UV exposure.

Mechanical endurance ratings (actuator)**Life**

100,000 cycles (actuation & release)

Frequency of operation

6 per minute

Vibration

5g, 0.7mm peak to peak, 10 sweeps, 10 to 500Hz

Shock

30g, 12ms

Bump

25g, 6ms for 1,000 cycles

Electrical ratings (contact blocks)

- ★ A600 & Q600 per UL508
- ★ AC15 & DC13 per IEC 60947-5-1

AC Life (AC15)

120Vac, 6A - 1,000k operations

DC Life (DC13)

24Vdc, 4A - 400k operations

N.C. Contacts

DOA (direct opening action) per IEC 60947-5-1

Short circuit co-ordination rating

1kA

Short circuit co-ordination fuse

GE Power Controls TIA 10, Red Spot type gG, 10A 660Vac 460Vdc, BS88-2, per IEC 60269-2-1

Standards & certifications

- ★ UL Listed E-Stop device per file # E217948
- ★ Certified to EN 60947-5-1 & EN 60947-5-5 per DEMKO certificate # 129648-01/A1
- ★ Certified to EN418 per DEMKO Certificate # 129648-02/A2
- ★ UL508 listed per file # E131568
- ★ CSA certified per file # LR68551

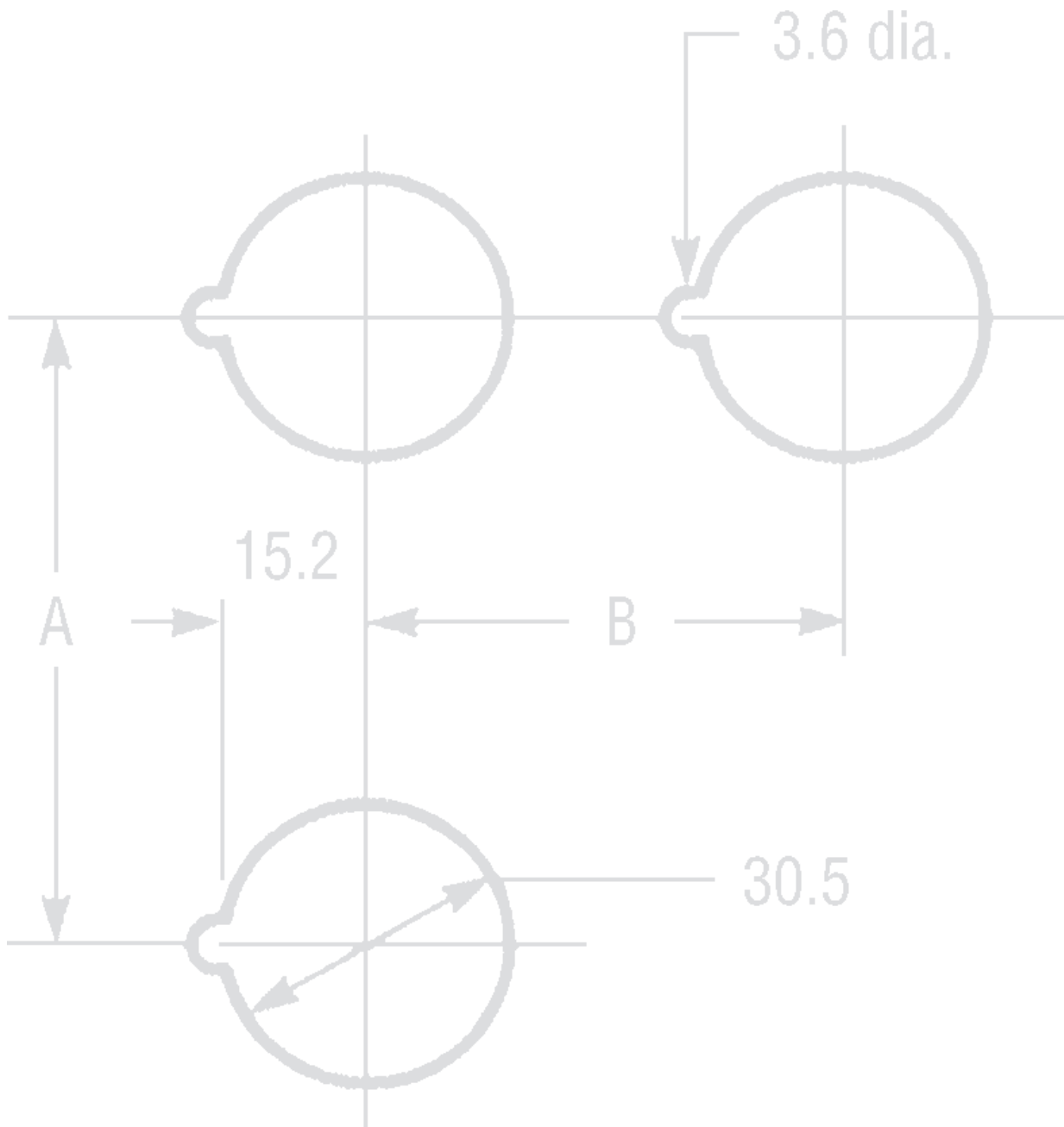







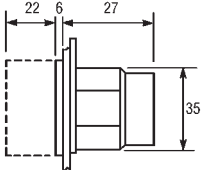

30.5mm operators – 91000T Series

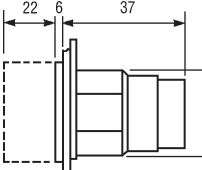
Description	Page	Description	Page
Pushbutton operators	32	Roto-push pushbuttons	38
Mechanical push operators	32	Joystick controllers	39
Illuminated pushbuttons	33	Legend plates	40
Cylinder lock pushbuttons	33	Accessories	41
Contact blocks	33	Assembled pushbutton stations	43
Knob or lever operated selector switches	34	Emergency stop stations	43
Key operated selector switches	35	Aluminium alloy enclosures	44
Standard indicating lights	36	Technical data	45
Prestest Indicating lights	37		

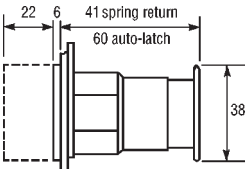
91000T Series - Pushbutton and mechanical push operators

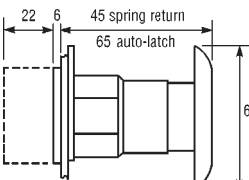
Pushbutton operators

Description	Button colour	Catalogue numbers	Overall dimensions (mm)	Weight (kg)
Flush button 	Black	91000T101		0.093
	Red	91000T102		0.093
	Green	91000T103		0.093
	Yellow	91000T104		0.093
	White	91000T106		0.093
	Blue	91000T108		0.093
Extended button 	Black	91000T111		0.093
	Red	91000T112		0.093
	Green	91000T113		0.093
Padlockable, lockdown Fitted with 38mm mushroom push 	Red	91000TA45		0.95
Complete flush operator Auto-latch	Red	91000T2821		0.95
Bare shaft operator For mushroom or palm push 	Momentary, spring return	91000T100		0.095
	Auto-latch	91000T140		0.095
Operating pushes for bare shaft operators				
Mushroom 38.1mm 	Black	91000T281		
	Red	91000T282		
	Green	91000T283		
	Yellow	91000T284		
	Blue	91000T288		
Palm 63.5mm 	Black	91000T291		
	Red	91000T292		
	Green	91000T293		
Extended pushbutton 	Red	91000T2820		

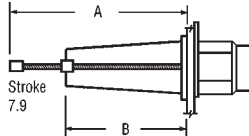

Mechanical push operators

Description	Colour	Catalogue numbers	Overall dimensions (mm)	Weight (kg)												
 Flush push, standard reach, 127mm	Black	91000TA85		0.015												
	Green	91000TA86		0.015												
	Red	91000TA87		0.015												
Flush push, long reach, 217mm	Black	91000TA97		0.015												
	Green	91000TA98		0.015												
	Red	91000TA99		0.015												
			<table border="1"> <thead> <tr> <th>Dimension</th> <th>A Min</th> <th>A Max</th> <th>B</th> </tr> </thead> <tbody> <tr> <td>Std. reach</td> <td>35</td> <td>127</td> <td>8</td> </tr> <tr> <td>Long reach</td> <td>118</td> <td>217</td> <td>85</td> </tr> </tbody> </table>	Dimension	A Min	A Max	B	Std. reach	35	127	8	Long reach	118	217	85	
Dimension	A Min	A Max	B													
Std. reach	35	127	8													
Long reach	118	217	85													

For base mounting contact block information see page 44

91000T Series - Illuminated and cylinder lock pushbuttons and contact blocks

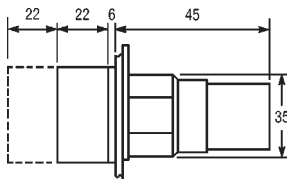
Illuminated pushbuttons BA9s bayonet fitting. For replacement bulbs see page 42.

	Description	Supply voltage 50/60Hz	Catalogue numbers	Overall dimensions (mm)	Weight (kg)
 <p>Operator</p>	Transformer type	110/120	91000T411		0.19
	6V 1W secondary.	220/240	91000T412		0.19
	Bulb supplied	380/415	91000T413		0.19
		440/480	91000T414		0.19
	Direct voltage				
	Supplied without bulb	6 to 240	91000T441		0.093
	BA9s bayonet bulbs (for use with 91000T441)				
 <p>Lens</p>	Filament type	6V (1W) flasher	28-2225-26		
		6.3V (1W)	28-2225-72		
		12V (1.2W)	28-2225-29		
		24V (1.2W)	28-2225-30		
		28V (1.12W)	28-2225-73		
		50V (1W)	28-2225-31		
		60V (1.2W)	28-2225-32		
		110V (2.2W)	28-2225-24		
		110V (0.8mA)	28-2225-48		
		240V (1.5mA)	28-2225-49		
	Neon type				

LED Bulbs see page 37

Plastic lens (for use with illuminated pushbuttons).

Colour	Catalogue numbers	Colour	Catalogue numbers	Colour	Catalogue numbers
Red	91000TC21	Amber	91000TC43	Clear	91000TC25
Green	91000TC22	Blue	91000TC24	White	91000TC26

Cylinder lock pushbuttons

Operators (Supplied with the standard lock and 2 keys, key ref. H661).

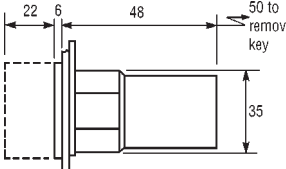
	Key position and pushbutton operation			Key removal positions	Catalogue numbers		Weight (kg)
	Left	Centre	Right				
	Lock-up	Free	Lock down	All	91000T430		0.185
	Blocked	Free	Push to lock	C & R	91000T437		0.185

Special lock selection: Add the appropriate suffix code from page 35. eg 91000T430H620.

Contact blocks

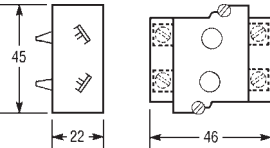
	Description	Catalogue numbers: One-hole mounting *	Overall dimensions (mm)	Weight (kg)
	1 N.O. 1 N.C.	91000T1		0.025
	2 N.O.	91000T2		0.025
	2 N.C.	91000T3		0.025
	1 N.C.	91000T51		0.025
	1 N.O.	91000T53		0.025
	2 N.O. 2 N.C.	91000T44		0.025
	1 N.O. 1 N.C. make before break	91000T55		0.025

Note:



A maximum of 6 blocks (12 circuits) may be fitted to each operator except for 91000T44 where a maximum of 4 blocks (16 circuits) may be fitted.

* For base mounting contact blocks see page 44.

91000T Series - Knob or lever operated selector switches

Knob or lever operated selector switches

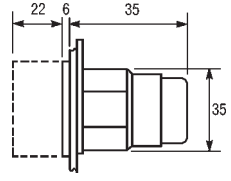
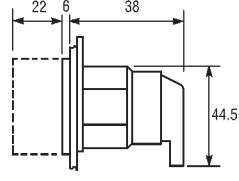
Bare shaft operator

	Description	Cam code	Catalogue numbers	Overall dimensions (mm)	Weight (kg)	
	2-position					
	Stayput	1	91000T4011		0.115	
	Spring return right to left	1	91000T4081		0.115	
	3-position					
	Stayput	2	91000T4022		0.115	
		3	91000T4023		0.115	
		4	91000T4024		0.115	
		6*	91000T4026		0.115	
	Spring return from left, stayput centre and right	2	91000T4032	0.115		
		3	91000T4033	0.115		
Spring return to centre from left and right	2	91000T4042	0.115			
	3	91000T4043	0.115			
Stayput left and centre, spring return from right	2	91000T4052	0.115			
	3	91000T4053	0.115			
	Knob (for any operator)		91000TKB			
	Lever (for any operator)		91000TLB			

Cam selection chart showing contact sequence

To determine the number of the cam you require and the right contact block select the contact sequence desired from table below. O = contacts open, X = contacts closed. The cam number is shown at top of column. The catalogue number of the appropriate contact block is shown at extreme left of table.

Catalogue numbers of contact block	Base mounting	Circuit (see note (1) at foot of table)	2-position selector switch		3-position selector switch			
			Cam code no. 1	Cam code no. 2	Cam code no. 3	Cam code no. 4	Cam code no. 6 †	
91000T1	91000T6	A N.C.	XO	OXO	OXX	XOO	XOO	
		B N.O.	OX	OOX	OOX	OXO	OXO	
91000T1	91000T6	A N.O.	OX	XOX	XOO	OXX	OOX	
		B N.C.	XO	XXO	XXO	XOX	OOX	
91000T2	91000T7	A N.O.	OX	XOX	XOO	OXX	OOX	
		B N.O.	OX	OOX	OOX	OXO	OXO	
91000T3	91000T8	A N.C.	XO	OXO	OXX	XOO	XOO	
		B N.C.	XO	XXO	XXO	XOX	OOX	

Switching angle.

60° between each position.



Note:

(1) Each contact block contains two contact circuits. The top set of contacts is identified as 'Circuit A' and the lower set as 'Circuit B' is indicated in the table. The chart shows the contact arrangements with the three contact blocks available and in each operator position. Additional contact combinations are obtainable by stacking contact blocks in tandem up to a maximum of 6 blocks (12 circuits).

† A maximum of 2 are to be used with cam 6. Rated fo A.C. only.

Key operated selector switches

Operators (Supplied with the standard lock and 2 keys, key ref. H661)

	Description code	Cam removal	Key Vertical position	Catalogue numbers Horizontal mounting *	dimensions mounting *	Overall (kg) (mm)	Weight
	2-position						
	Stayput	1	Right & left	91000T15113	91000T16113		0.185
	Spring return right to left	1	Left only	91000T15712	91000T15812		0.185
	3-position						
	Stayput	2	Left, right	91000T15227	91000T16227		0.185
		3	& centre	91000T15237	91000T16237		0.185
		4		91000T15247	91000T16247		0.185
		6		91000T15267	91000T16267		0.185
	Spring return from left	2	Right & centre	91000T15325	91000T16325		0.185
		3		91000T15335	91000T16335		0.185
	Spring return to centre from left and right	2	Centre only	91000T15424	91000T16424		0.185
		3		91000T15434	91000T16434		0.185
	Spring return from right	2	Left & centre	91000T16526	91000T16626		0.185
3			91000T16536	91000T16636		0.185	

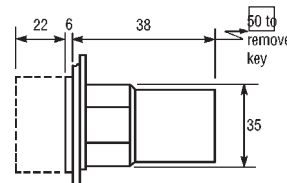

* **Vertical mounting** means terminals are left & right of contact block.

Horizontal mounting means terminals are top & bottom of contact block. This allows close spacing of adjacent operators with easy access to terminals.

Alternative key removal position selection

To select an alternative key removal position change the last digit of the listed catalogue number with a code from the table below e.g. 91000T1522**6** is a 3 position stayput switch with key removal from left and centre.

Key removal position	Suffix
Right	1
Left	2
Right and Left	3
Centre	4
Right and Centre	5
Left and Centre	6
All Positions	7

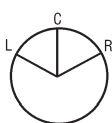

Note: Select one suffix number only. Key removal in a spring return position is not available.

Special lock selection

To select an alternative lock add the suffix code from the table below to the operator catalogue number e.g. 91000T15113**H621**



Special lock Suffix	Suffix
H620	H654
H621	H663
H634	H675
H635	H683
H639	H688
H643	—

Special locks are supplied with two keys. Extra keys may be ordered, refer to accessories page 42.

91000T Series - Standard indicating lights

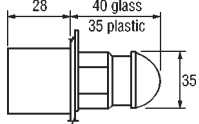
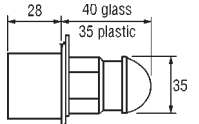

Standard indicating lights

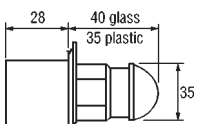
Lamp units Bulbs supplied with units unless otherwise stated. For replacement light bulbs see page 42

	Description	Supply volts 50/60Hz	Catalogue numbers	Overall dimensions (mm)	Weight (kg)	
	Transformer type	110/120	91000T181N		0.22	
	6V 1W secondary BA9s	220/240	91000T182N		0.22	
	bayonet bulb under rated by	380/415	91000T183N		0.22	
	10% for longer life.	550/600	91000T185N		0.22	
	Resistor type	110/120	91000T201N			0.112
	120V 2.2W	220/240	91000T202N	0.112		
		Direct voltage unit (MCC/MBC)				
		Supplied without bulb. Suitable for BA9s bayonet bulbs	6 to 240	91000T197N		0.11
		BA9s bayonet bulbs (for use with 91000T197N)				
		Filament type	6V (1W) flasher	28-2225-26		
		6.3V (1W)	28-2225-72			
		12V (1.2W)	28-2225-29			
		24V (1.2W)	28-2225-30			
		28V (1.12W)	28-2225-73			
		50V (1W)	28-2225-31			
		60V (1.2W)	28-2225-32			
		110V (2.2W)	28-2225-24			
	Neon type	110V (0.8mA)	28-2225-48			
		240V (1.5mA)	28-2225-49			
	Direct voltage unit (SBC)				0.11	
	Supplied without bulb. Suitable for BA15d bayonet bulb	6 to 240	91000T200N			
	BA15d bulbs (filament type)	6	28-2225-18			
	6 – 10 watt.	12	28-2225-19			
	For use with 91000T200N	24	28-2225-20			
		48	28-2225-21			
		130	28-2225-22			
		240	28-2225-23			

LED Bulbs see page 37

Lenses

	Colour	Catalogue numbers	
		Plastic	Glass
	Red	91000TC1N	91000TC7N
	Green	91000TC2N	91000TC8N
	Amber	91000TC19N	91000TC9N
	Blue	91000TC4N	91000TC10N
	Clear	91000TC5N	91000TC11N
	White	91000TC6N	91000TC12N
			

91000T Series - Pretest indicating lights

Pretest indicating lights

Lamp units For replacement light bulbs see page 42.

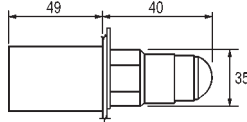
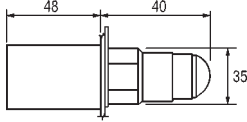
	Description	Supply volts 50/60Hz	Catalogue numbers	Overall dimensions (mm)	Weight (kg)
	Transformer type 6V 1W secondary BA9s bayonet bulb underrated by 10% for longer life	110/120	91000T221N		0.29
		220/240	91000T222N		0.29
		380/415	91000T223N		0.29
	Resistor type 120V 2.2W BA9s bayonet bulb	110/120 220/240	91000T231N 91000T240N		0.185 0.185
	Direct voltage unit (MCC/MBC) Suitable for BA9s bayonet bulbs	6 to 240	91000T230N		0.175
	BA9s bayonet bulbs (for use with 91000T230N) Filament type				
		6.3V (1W)	28-2225-72		
		12V (1.2W)	28-2225-29		
		24V (1.2W)	28-2225-30		
		50V (1W)	28-2225-31		
		60V (1.2W)	28-2225-32		
		110V (2.2W)	28-2225-24		
	Neon type	110V (0.8mA)	28-2225-48		
		240V (1.5mA)	28-2225-49		

LED bulbs



Colour	Catalogue numbers			
	Upto 60Vac/dc	120Vac	120Vdc	135Vac/dc
Blue	E22LED*BN	E22LED120BA	E22LED120BD	E22LED135BD
Green	E22LED*GN	E22LED120GA	E22LED120GD	E22LED135GD
Orange	E22LED*ON	E22LED120OA	E22LED120OD	E22LED135OD
Red	E22LED*RN	E22LED120RA	E22LED120RD	E22LED135RD
White	E22LED*WN	E22LED120WA	–	E22LED135WD
Yellow	E22LED*YN	E22LED120YA	E22LED120YD	E22LED135YD

Voltage code

Voltage	Code
10Vac – 6Vdc	006
12Vac – 12Vdc	012
24Vac – 24Vdc	024
35Vac – 35Vdc	035
48Vac – 48Vdc	048
60Vac – 60Vdc	060

*Add voltage code alongside to complete catalogue number

Lenses

	Colour	Catalogue numbers	
		Plastic	Glass
 <i>Plastic</i>  <i>Glass</i>	Red	91000TC21	91000TC13N
	Green	91000TC22	91000TC14N
	Amber	91000TC43	91000TC15N
	Blue	91000TC24	91000TC16N
	Clear	91000TC25	91000TC17N
	White	91000TC26	91000TC18N

91000T Series - Roto-push pushbuttons

Roto-push pushbutton (a combined selector switch and pushbutton)

Description
colourButton
VerticalCatalogue numbers
Horizontal
mounting dimensions
mountingOverall
(kg)
(mm)

Weight

Black
Green

91000T241*

91000T251*

91000T243*

91000T253*

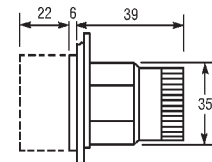

0.128

0.128

* Complete the catalogue number by adding the respective cam code number from the table below. Example: 91000T24111 is a 2 position roto-push for use as shown below.

Typical application run-inch, start-inch

2 position roto-push 91000T24111 + 91000T1

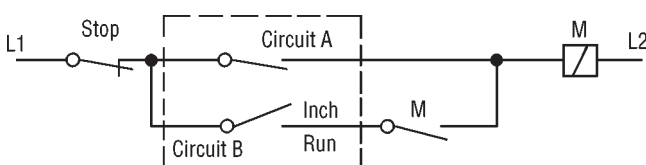

With the roto-push sleeve turned to Inch depression of the push energises coil M through circuit A only so long as the push is pressed i.e. the motor will inch. With the roto-push sleeve turned to Run, the roto-push contact connected to the maintaining contact of M through circuit B is permanently closed, thus when the push is pressed (circuit A) M will close and maintain itself and the motor will run.

Cam selection chart showing contact sequence

O = contacts open, X = contacts closed. The catalogue number of the appropriate contact block is shown at extreme left of table.

Catalogue number of contact block		Button position	Circuit †	2 position operators								3 position operators			
One hole mounting	Base mounting			Cam code number								7	8	9	
				1	2	3	4	5	6	10	11				
91000T1	91000T6	N	A N.C.	XX	XX	XO	XX	XX	XO	XX	XX	XXX	XOX	XO0	
			B N.O.	OO	OO	OX	OX	OX	OX	OX	OX	OX	OXX	OXO	OOX
		D	A N.C.	XO	XO	OO	OO	XO	XO	OX	OX	OO	OXO	OOX	XO0
			B N.O.	XO	XX	XX	XX	OX	XX	OX	OX	OX	OXX	OXX	OOX
91000T1§	91000T6§	N	A N.O.	OO	OO	OX	OO	OO	OX	OO	OO	OOO	OXO	OOX	
			B N.C.	XX	XX	XO	XO	XO	XO	XO	XO	XOO	XOX	XXO	
		D	A N.O.	OX	OX	XX	XX	OX	OX	OX	XO	XX	XOX	XXO	OXX
			B N.C.	OX	OO	OO	OO	XO	OO	XO	XO	XOO	XOO	XOO	XXO
91000T2	91000T7	N	A N.O.	OO	OO	OX	OO	OO	OX	OO	OO	OOO	OXO	OOX	
			B N.O.	OO	OO	OX	OX	OX	OX	OX	OX	OXX	OXO	OOX	
		D	A N.O.	OX	OX	XX	XX	OX	OX	OX	XO	XX	XOX	XXO	OXX
			B N.O.	XO	XX	XX	XX	OX	XX	OX	OX	OXX	OXX	OOX	
91000T3	91000T8	N	A N.C.	XX	XX	XO	XX	XX	XO	XX	XX	XXX	XOX	XO0	
			B N.C.	XX	XX	XO	XO	XO	XO	XO	XO	XOO	XOX	XXO	
		D	A N.C.	XO	XO	OO	OO	XO	XO	OX	OO	OXO	OOX	XO0	
			B N.C.	OX	OO	OO	OO	XO	OO	XO	XO	XOO	XOO	XXO	

Note: Cam codes 6 & 7 are for ac use only.

† Each contact block contains two contact circuits. The top set of contacts is identified as 'circuit A' and the lower set as 'B'. The table shows contact arrangement of each contact block with the operating button in normal and depressed positions and in each rotary sleeve position.

Additional combinations are obtainable by stacking contact blocks in tandem.

§ These contact blocks are the same as the ones above except rotated 180° when assembled to the operator.

Switching angle: 60°

N = Button in free or normal position

D = Button depressed

Joystick controllers



Eight circuit
Non-latched operator

- Supplied with 4 position gate fitted
- 3 additional gates supplied which allows conversion to 2, 3 or 8 positions. (T1030, T1050, T1020)
- Up to eight switching positions
- Up to twelve circuits.
- Each circuit N.O. or N.C. required a.c. or d.c.

Description	Catalogue numbers	
	Without latch:	With off position latch:
Spring return only	91000T450	91000T460
Field adjustable spring return to stayput	91000T451	91000T461

Overall dimensions (mm)

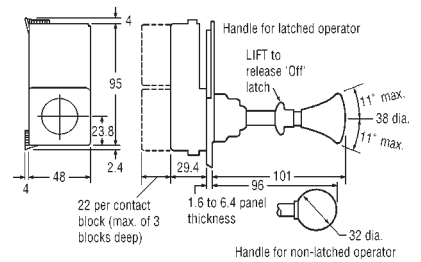

Contact blocks

Description	Catalogue numbers
1 N.O. – N.C.	91000T1
2 N.O.	91000T2
2 N.C.	91000T3
1 N.O. 1N.C. make before break	91000T55

Panel drilling dimensions (mm)

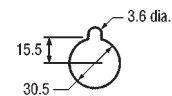

Legend plates

Description	Catalogue numbers
Blank	91000TJS1
Engraved	91000TJS2
Hole plug	91000TA700

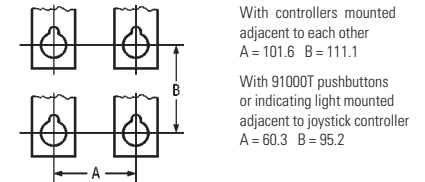

Positioning gate 91000T1010 is fitted as standard to each operator

The arrows shown in the 'Handle positions' column A indicates the handle positions and movements available when the indent mark on the gate is adjacent to the letter A on the handle assembly base casting. (No indent mark is provided on gates 91000T1010 and T1020).

Gate profile	Handle position				Catalogue numbers
	A	B	C	D	
					91000T1010
					91000T1020
					91000T1030
					91000T1040
					91000T1050
					91000T1060
					91000T1070
					91000T1080
					91000T1090

Gate profile	Handle position				Catalogue numbers
	A	B	C	D	
					91000T1100
					91000T1110
					91000T1120
					91000T1130
					91000T1130*
					91000T1140
					91000T1150
					91000T1150*
					91000T1160

* These positioning gates are identical with the one immediately above them. The handle positions shown against these profiles are obtained when the positioning gate is fitted with the indent mark not visible i.e. in contact with the common gate.

91000T Series - Legend plates

Legend plates



Medium



Large

Legend	Catalogue numbers		Legend	Catalogue numbers		Legend	Catalogue numbers	
	Medium	Large		Medium	Large		Medium	Large
	91000T	91000T		91000T	91000T		91000T	91000T
Auto off hand	M49	J49	Inch Run	M41	J41	Raise	M28	J28
(Blank)	M36	J36	Inch Safe Run	M52	J52	Raise Lower	M76	J76
(Blank)§	M37	J37	Jog	M19	J19	Ready	M78	J78
(Blank)	M95†	J95†	Left	M73	J73	Reset	M29	J29
(Blank)§	M96†	J96†	Left Right	M74	J74	Reverse	M30	J30
Close	M11	J11	Local Off			Right	M79	J79
Down	M12	J12	Remote	M66	J66	Run	M31	J31
Emerg Stop§	M13	–	Local Remote	M63	J63	Run Inch	M44	J44
Emergency			Low	M22	J22	Safe Run	M45	J45
Stop§	–	J13	Lower	M23	J23	Seq. Test	M62	J62
Fast	M14	J14	Man Auto	M67	J67	Slow	M32	J32
For Off Rev	M50	J50	Man Off Auto	M68	J68	Slow Fast	M84	J84
For Rev	M38	J38	Motor Run	M58	J58	Slow Off Fast	M85	J85
Forward	M15	J15	Motor Running	M56	J56	Start	M33	J33
Hand Auto	M39	J39	Motor Stop§	M59	J59	Start Inch	M46	J46
Hand Off Auto	M51	J51	Motor Stopped	M57	J57	Start Stop	M47	J47
High	M16	J16	Off	M64	J64	Stop§	M34	J34
High Low	M40	J40	Off§	M24	J24	Stop Reset§	M88	J88
I	M65	J65	Off On	M42	J42	Stop (Turn barrel to release)§	M90	–
In	M17	J17	On	M25	J25	Supply On	M61	J61
Inch	M18	J18	Open	M26	J26	Test	M60	J60
Inch For	M20	–	Open Close	M43	J43	Up	M35	J35
Inch Forward	–	J20	Open Off Close	M53	J53	Up Down	M48	J48
Inch Rev	M21	–	Out	M27	J27	Up Off Down	M54	J54
Inch Reverse	–	J21	Power On	M55	J55			

The standard colour field is black, except for those legends marked § for which the standard colour is red. Legends marked thus † are of brass. All other legends are of aluminium.

Non-standard legends

If a legend not quoted above is required, give the blank catalogue number for the size/colour and add the suffix 'X' to the code, indicating (e.g. by dashes not to be reproduced on the plate) the number of positions to be catered for, e.g. M36X JET-OFF-SPRAY (medium, black, 3-position).

The following table gives the maximum number of letters of a certain size which can be engraved on standard legend plates.

Type	Letter size (mm)		3.2		4.8		6.4		8		9.5		12.7	
	No. of lines	No. of letters	No. of lines	No. of letters	No. of lines	No. of letters	No. of lines	No. of letters	No. of lines	No. of letters	No. of lines	No. of letters	No. of lines	No. of letters
Medium	3	24	2	12	1	8	1	6	1	4	1	4	–	–
Large	6	30	4	15	3	10	2	7	2	5	1	5	1	3

Dimensions (mm)

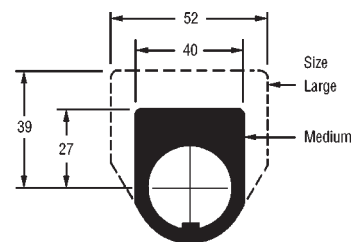

Note: Two large size legend plates cannot be mounted one above the other on standard enclosures.





Accessories

	Description	Catalogue numbers
Padlock attachments		
	Padlock attachment for stop button. Permits locking N.C. contacts in open position, prevents operation of button	91000TA2
	Padlock attachment with hinged transparent flap, for flush or extended pushbuttons, and knob-operated selector switches	91000TA38

Boots

	Protective boot for flush pushbutton operators	Blue	91000TA46
		Black	91000TA47
		Red	91000TA48
		Green	91000TA49
		Yellow	91000TA50
	Protective boot for mushroom and palm pushbutton operators. Not suitable for use with 91000T140	Black	91000TA88
	Protective boot for extended pushbutton operators	Black	91000TA3
		Red	91000TA4
		Green	91000TA10

Guards and shrouds

	Guard sleeve for flush pushbutton	91000TA12
	Guard sleeve for mushroom head operator. Chrome finish. Prevents accidental operation. Not suitable for use with 91000T140	91000TA6
	Guard sleeve for illuminated pushbutton. Prevents accidental operation	91000TA15

Lever operator

Description	Catalogue number
 Lever for release of a staydown pushbutton or roto-push operator.	91000TA13

91000T Series - Accessories

Accessories

Trip and reset attachment

Description	Catalogue number
Trip and reset attachment. Use with two pushbutton operators and one or more contact blocks. The contact blocks are mounted under the reset or stop push which latches in the depressed position until released by depression of the trip push.	91000TA1



Replacement light bulbs *

Type	Voltage	Used on	Catalogue numbers
BA9s flasher filament	6	91000T181N – 185N 91000T221N – 223N 91000T411 – 414	28-2225-26
BA9s filament	6.3	91000T181N – 185N 91000T221N – 223N 91000T411 – 414	28-2225-72
BA9s filament	110/120	91000T201N,T202N 91000T231N,T240N	28-2225-24



Note:



* Replacement bulbs are for use with current series 'B' operators. For replacement bulbs for series 'A' (round bezelled) operators contact Eaton Limited.

Bulb removal tool

BA9s and BA15d type bulbs	91000TA65
---------------------------	------------------

Other accessories





Description	Catalogue numbers
Wobble stick complete with locking ring for mounting on a flush pushbutton. Designed for emergency or hurried operation	91000TA5
 Plug for unused hole in cover. Finish in light grey (RAL 7032)	91000TA7
 Protective washer, used as substitute when legend plate is not required. Prevents locking ring from scratching paint.	91000TA8
Double ended box spanner for easy installation of control units on panel. (Will not fit over selector switch levers).	E22CW
 Box spanner. Notched to fit over selector switch levers.	91000TA95

Description	Catalogue numbers
Boot spanner. For easy installation of operators fitted with protective boots.	91000TA96
 2 spare keys for special locks, state key 'H' code as suffix e.g.91000TA151H620	91000TA151H*
2 spare keys for standard lock ref. no. H661	91000TA152
6-32 stacking screws for series B operators	91000TA79 (pack of 10)
 Octagonal bezel with 26 T.P.I. to convert round style pushbutton operators to octagonal	91000TA202
 Terminal boots. Provides IP20 (fingerproof protection) for terminals	91000TA81 (pack of 10)



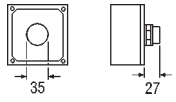

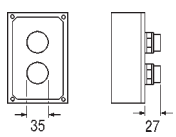
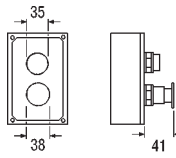
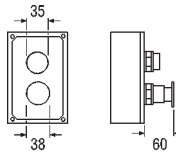
Assembled pushbutton stations

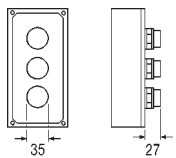
Features and characteristics

- Oiltight stations
- IP65 ingress protection
- Surface mounted die-cast aluminium enclosures
- Threaded conduit entry
- Powder coat painted light grey (RAL7032)

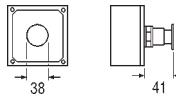
Description	Operator	Contact arrangement	Catalogue numbers	Weight (kg)	Operator dimensions (mm)
Single way station 	Start	N.O. – N.C.	91000T3516	0.68	
Two way stations 	Start Stop	N.O. – N.C. N.C.	91000T3525	0.98	
	Start Mushroom stop (spring return)	N.O. – N.C. N.C.	91000T3526	0.98	
	Start Mushroom stop (auto latch)	N.O. – N.C. N.C.	91000T3630	0.98	
Three way stations 	Forward Reverse Stop	N.O. – N.C. N.O. – N.C. N.C.	91000T3532	1.3	
	Open Close Stop	N.O. – N.C. N.O. – N.C. N.C.	91000T3614	1.3	
	Up Down Stop	N.O. – N.C. N.O. – N.C. N.C.	91000T3615	1.3	

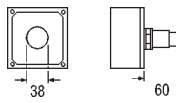
Emergency stop stations

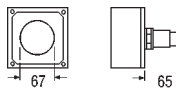
	38mm dia. red mushroom push. Momentary spring return. Yellow lid.	N.C.	91000T3553	
	38mm dia. red mushroom push. Stop-lock, twist barrel to release. Yellow lid.	N.C.	91000T3554	
	63mm dia. red palm push. Stop lock, twist barrel to release. Yellow lid.	N.C.	91000T3555	

Note: For enclosure dimensions see page 44.

91000T Series - Aluminium alloy enclosures

Aluminium alloy enclosures

Description Painted light grey (RAL7032) textured finish	Operator capacity per enclosure	Catalogue numbers One contact block deep:	Two contact blocks deep:
	1	91000TN1	91000TN11
	1†	91000TN100	—
	2	91000TN2	91000TN12
	3	91000TN3	91000TN13
	4	91000TN4	91000TN14

3 operator enclosure

† Enclosure has yellow lid

Accessories

Description	Catalogue numbers
Spacers  Used for base mounting contact blocks. One required for each operator plus additional spacer may be required to make up enclosure depth.	One contact block deep 91000TA21 Two contact blocks deep 91000TA22

Base mounting contact blocks

1 N.O. 1 N.C.	91000T6
2 N.O.	91000T7
2 N.C.	91000T8
1 N.C.	91000T52
1 N.O.	91000T54

Dimensions (mm)

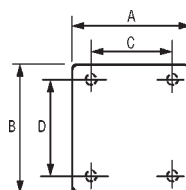
1,2,3 & 4 unit sizes
single contact
block depth1,2,3 & 4 unit sizes
double contact
block depth

Enclosure size	Dimensions		C	D	E	Conduit entry	Fixing holes	Weight (kg)
	A	B						
1 unit	97	102	68.3	82.6	69	20	5.6	0.050
2 unit	97	149	68.3	130.2	74	25	5.6	0.65
3 unit	97	197	68.3	177.8	74	32	5.6	0.775
4 unit	100	248	68.3	225	76	32	5.6	0.95

Technical data

Standards and approvals

IEC 947-5-1. MTTA*
 CSA C22-2 no. 14, UL508

Ingress protection (IP ratings to IEC144 (BS5420))

IP65
 IP66, NEMA 4 on pushbuttons when fitted with a rubber boot
 IP65 on enclosures

Max. frequency of operations

All pushbuttons: 6000 ops/hr.
 Key and lever selector switch: 3000 ops/hr.
 Auto-latch devices: 1200 ops/hr.

Mechanical life

Pushbuttons: 10 x 10⁶ operations
 Contact blocks: 10 x 10⁶ operations
 Pretest units: 1 x 10⁶ operations
 Lever & key sel. sw.: 0.25 x 10⁶ operations
 Twist to release p/btns: 0.3 x 10⁶ operations

Climatic conditions

Operating: Max 60°C at 95% RH.
 Temp. -17°C to +66°C
 Altitude 2000 metres
 Storage: Max. 60°C at 95% RH.
 Temp. -40°C to +80°C

Shock resistance

Shock duration: 20 ms ± 5g

Electrical ratings

Rated insulation: U_i = 660V ac or dc
 Rated thermal: I_{th} = 10A
 Short circuit (IEC947-5-1): 1000A with a 6A (NIT) fuse (to BS88)
 NEMA, UL rating: A600, P600
 AC load life duty cycle 1200 ops/hr
 10A 110V pf 0.4 - 1 x 10⁶ operations
 5A 250V pf 0.4 - 1 x 10⁶ operations
 2A 660V pf 0.4 - 1 x 10⁶ operations

Switching capacity

AC15 rated make/break (11 x I_e at 1.1 x U_e)
 6A 120V pf 0.7
 4A 240V pf 0.7
 2A 660V pf 0.7
 DC13 rated make/break (1.1 x I_e at 1.1 x U_e)
 1.0A 120V L/R ± 0.95 at 300ms
 0.5A 240V L/R ± 0.95 at 300ms
 0.1A 660V L/R ± 0.95 at 300ms
 10A 110V pure resistive

Light units

Transformers will withstand short circuit for 1 hour per IEC947-5-1.
 Bulbs average life:
 Transformer type = 20,000 hrs.
 Resistor/direct voltage type = 2,500 hrs min. at rated voltage.

Low voltage switching

Conical shaped points or "reliability nibs" improve performance in dry circuit, corrosive, fine dust and other contaminated atmospheres. Under normal environmental conditions, the minimum operational voltage is 5V and the minimum operational current is 1mA, ac/dc.

Contact operation

Slow make and break. All normally closed contacts have positive opening operation. i.e. normally closed contacts are forced open in the event of contact weld or spring breakage.

Terminal marking

Dual marking system 1 – 2 for normally closed 3 – 4 normally open to meet BS5472 (Cenelec EN50 005) and N.C. – N.O. moulded in the contact block to meet the NEMA requirements.

Terminal clamps

Terminals are saddle clamp types for 1 x 0.5mm" to 2 x 3mm" conductors.

Panel thickness

Maximum = 8mm including legend plate.
 Minimum = 1.6mm.

***M.T.T.A. (Machine Tool, Trades Association)**

A range of pushbutton operators to meet the requirements of M.T.T.A. standard "Electrical Equipment of Machine tools and other industrial machines and equipment for the automobile industry" are included in the 91000T range.

Mounting matrix

Legend plate	A	B	C	D
Medium	57	45	45	57
Large	57	57	57	57

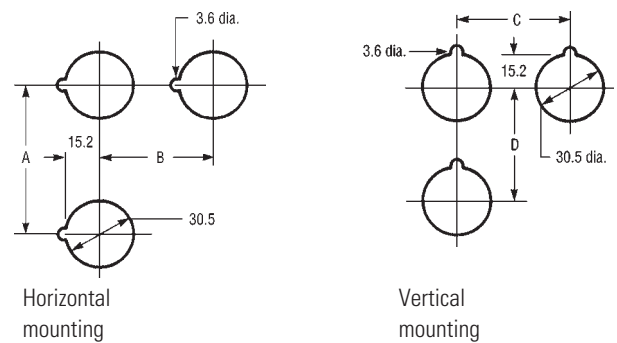

Vertical mounting means terminals are left & right of contact block. Horizontal mounting means terminals are top & bottom of contact block. This allows close spacing of adjacent operators with easy access to terminals.

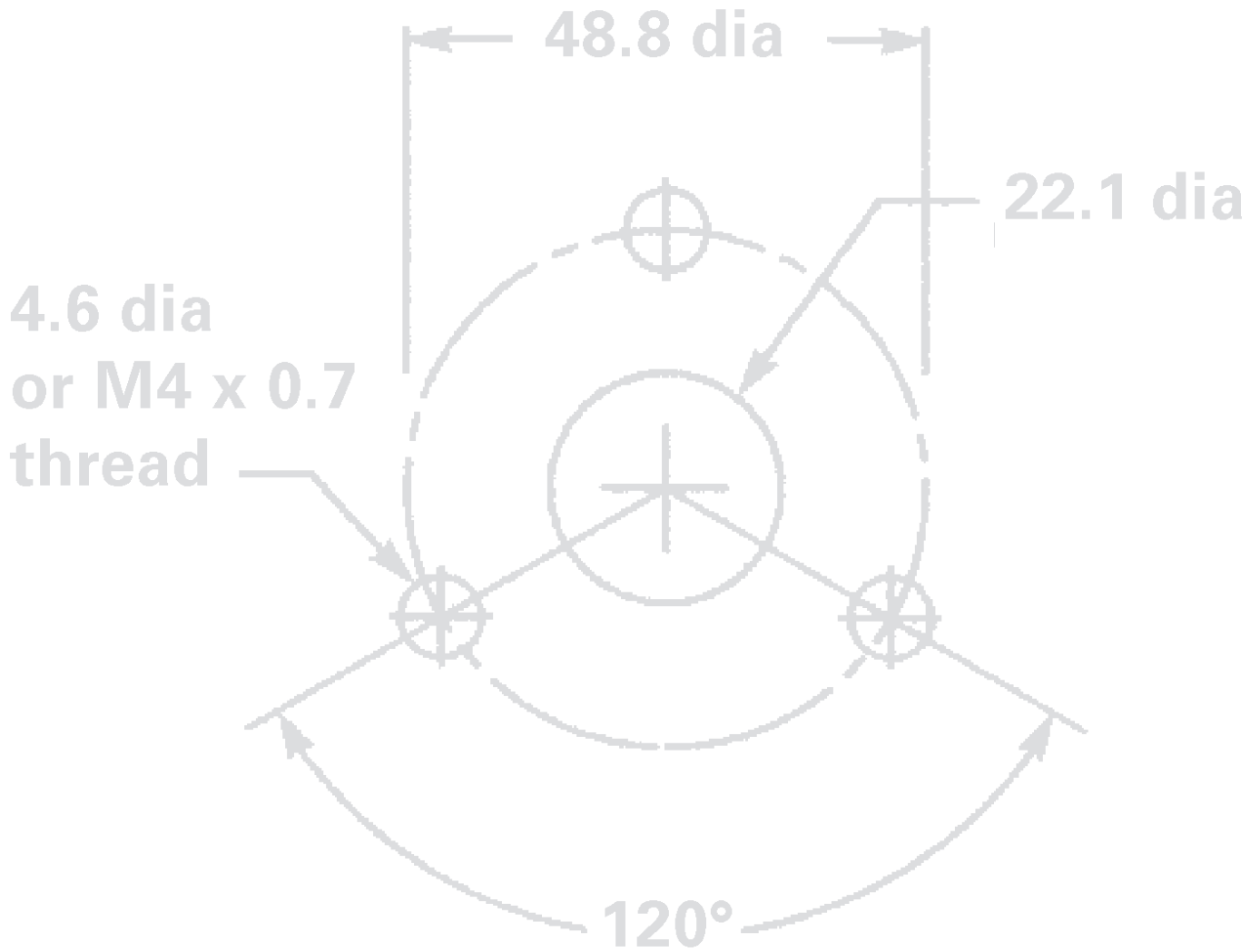

Stacklights – E26 Series

Description

- Product description
- Catalogue number selection guide
- Light and xenon strobe modules
- Accessories
- LEDs - Cluster or cylindrical

Page

- 48
- 48
- 49
- 50
- 53

Description

- Technical data
- Application data
- Mounting options and dimensions
- Dimensions

Page

- 54
- 54
- 55
- 56

E26 Series - Product description

Product description

The E26 Stacklight unit is a modular system that provides illuminated and audible status indication in all directions. Easily assembled plug-in modular units include constant, flashing and strobe light units, as well as mono-tonal, bitonal, intermittent alarm systems. Stacklights may be assembled in a variety of configurations, which are identified in the Maximum Configurations table below. Numerous lamp, colour and mounting options further enhance the Stacklight's versatility.



Light module

Light modules

Available in a variety of colours for both incandescent lamps and LED lamps. To maximise illumination and light dispersion, incandescent units include an opal white diffuser while LED diffusers are clear. See page 49.

Xenon strobe

Sets are similar to standard lens/diffuser units, except each set consists of two lens units. The lower unit includes the electronics and is permanently fused to the upper unit which contains the Xenon lamp. Xenon units may be placed in any position in a complete Stacklight unit. They will flash 60 times per minute when used with a standard or flashing base. See page 49.

Catalogue number selection

Complete Stacklight modules

- ★ Stacklights accept a maximum of 6 incandescent or LED light modules or 2 Xenon flasher modules and can be mounted in any position on the stack.
- ★ Alarm units are mounted in the top most position only.



Standard base and top cover

Standard Stacklight base

For use with incandescent or standard LED for steady, non-flashing illumination or with flashing LEDs for flashing illumination. Bases include terminal block for wiring, stacklight cover and gasket. See page 50.



Flashing base and top cover

Flashing Stacklight base

Allows configuration of each light in the stack for either steady or 60 times per minute flashing illumination. Flashing circuit for use with incandescent lamps only. (Maximum allowable number of light modules is 2 at 12V, 4 at 24V and 6 at 48V and above.) See page 50.

For flashing LEDs use standard base with flashing LED light module.



Alarm

Alarms

May be fitted to the top of a complete Stacklight unit or directly to the Stacklight bases, if desired. Available in three versions, each with adjustable sound levels. See page 51.

Features

- Modular construction
- Wide variety of lens colours
- Variety of lamp types and voltages
- Mono-tonal, bi-tonal and intermittent alarm systems

Benefits

- Combination of visible and audible alarms
- Modular components reduce inventory requirements, increase flexibility
- Steady and flashing modes allow one light to signal multiple conditions
- No-tools assembly permits easy lamp replacement

Maximum configurations

Incandescent or LED modules	Xenon modules	Alarm modules	Max. number of modules
6	–	–	6
5	–	1	6
4	1	–	5
3	1	1	5
2	2	–	4
1	2	1	4

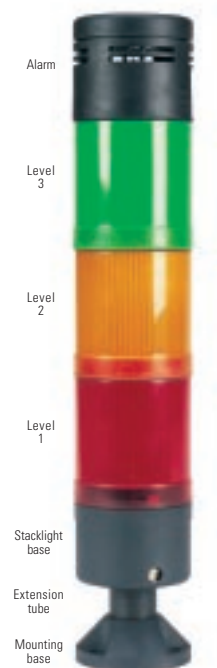

Complete Stacklight module

Light and xenon strobe modules (includes lens, diffusers and bulbs unless otherwise noted)

- Light modules include lens diffusers which provide even illumination and eliminate hot spots.
- Xenon strobes emit a bright attention-getting white flashing light. Flash rate = 60/min.
- Xenon strobe modules occupy two positions in the Stacklight assembly.



Light/LED module

LED/Lamp voltage	Lens colour	Incandescent Catalogue numbers Steady or Flashing	Cluster LED Catalogue numbers		Cylindrical LED Catalogue numbers Steady only	Xenon Catalogue numbers Flashing
			Steady	Flashing		
Without bulb or LED	Red	E26B2	E26BR	E26BR	E26BR	—
	Green	E26B3	E26BG	E26BG	E26BG	—
	Yellow	E26B4	E26BY	E26BY	E26BY	—
	Blue	E26B6	E26BB	E26BB	E26BB	—
	Amber	E26B9	E26BA	E26BA	E26BA	—
	Clear	E26B0	E26BW	E26BW	E26BW	—
12V ac/dc	Red	E26B2V1	E26BRV1	E26BEV1	E26BR1V1	E26BX2V1
	Green	E26B3V1	E26BGV1	E26BUV1	E26BG1V1	E26BX3V1
	Yellow	E26B4V1	E26BYV1	E26BVV1	E26BY1V1	E26BX4V1
	Blue	E26B6V1	E26BBV1	E26BKV1	E26BB1V1	E26BX6V1
	Amber	E26B9V1	E26BAV1	E26BZV1	E26BA1V1	E26BX9V1
	Clear	E26B0V1	E26BWW1	E26BMV1	E26BW1V1	E26BX0V1
24V ac/dc	Red	E26B2V2	E26BRV2	E26BEV2	E26BR1V2	E26BX2V2
	Green	E26B3V2	E26BGV2	E26BUV2	E26BG1V2	E26BX3V2
	Yellow	E26B4V2	E26BYV2	E26BVV2	E26BY1V2	E26BX4V2
	Blue	E26B6V2	E26BBV2	E26BKV2	E26BB1V2	E26BX6V2
	Amber	E26B9V2	E26BAV2	E26BZV2	E26BA1V2	E26BX9V2
	Clear	E26B0V2	E26BWW2	E26BMV2	E26BW1V2	E26BX0V2
48V ac/dc	Red	E26B2V3	E26BRV3	E26BEV3	E26BR1V3	E26BX2V3
	Green	E26B3V3	E26BGV3	E26BUV3	E26BG1V3	E26BX3V3
	Yellow	E26B4V3	E26BYV3	E26BVV3	E26BY1V3	E26BX4V3
	Blue	E26B6V3	E26BBV3	E26BKV3	E26BB1V3	E26BX6V3
	Amber	E26B9V3	E26BAV3	E26BZV3	E26BA1V3	E26BX9V3
	Clear	E26B0V3	E26BWW3	E26BMV3	E26BW1V3	E26BX0V3
120V ac *	Red	E26B2V4	E26BRV4	E26BEV4	E26BR1V4	E26BX2V4
	Green	E26B3V4	E26BGV4	E26BUV4	E26BG1V4	E26BX3V4
	Yellow	E26B4V4	E26BYV4	E26BVV4	E26BY1V4	E26BX4V4
	Blue	E26B6V4	E26BBV4	E26BKV4	E26BB1V4	E26BX6V4
	Amber	E26B9V4	E26BAV4	E26BZV4	E26BA1V4	E26BX9V4
	Clear	E26B0V4	E26BWW4	E26BMV4	—	E26BX0V4
240V ac *	Red	E26B2V5	E26BRV5	E26BEV5	—	E26BX2V5
	Green	E26B3V5	E26BGV5	E26BUV5	—	E26BX3V5
	Yellow	E26B4V5	E26BYV5	E26BVV5	—	E26BX4V5
	Blue	E26B6V5	E26BBV5	E26BKV5	—	E26BX6V5
	Amber	E26B9V5	E26BAV5	E26BZV5	—	E26BX9V5
	Clear	E26B0V5	E26BWW5	E26BMV5	—	E26BX0V5

* Incandescent bulbs are ac/dc rated, LEDs are ac rated only.

E26 Series - Accessories

Accessories

	Description	Voltage	Catalogue numbers	Approximate dimensions (mm) ①
	<p>Standard base For use with steady incandescent or steady/ flashing LED</p>	<p>12V ac/dc to 240V ac/dc</p>	<p>E26BL</p>	<p>Drill 2 holes in Stacklight base to 4.3 mm. Mount Stacklight with M4 screws. Tighten to torque of 0.79 Nm.</p>
	<p>Flashing base Enables configuration of incandescent light modules for steady or flashing operation</p>	<p>12V dc 24V ac/dc 48V ac/dc 240V ac/dc 120V ac/dc</p>	<p>E26BFV1 E26BFV2 E26BFV3 E26BFV4 E26BFV5</p>	<p>Drill 2 holes in Stacklight base to 4.3 mm. Mount Stacklight with M4 screws. Tighten to torque of 0.79 Nm.</p>

Standard base

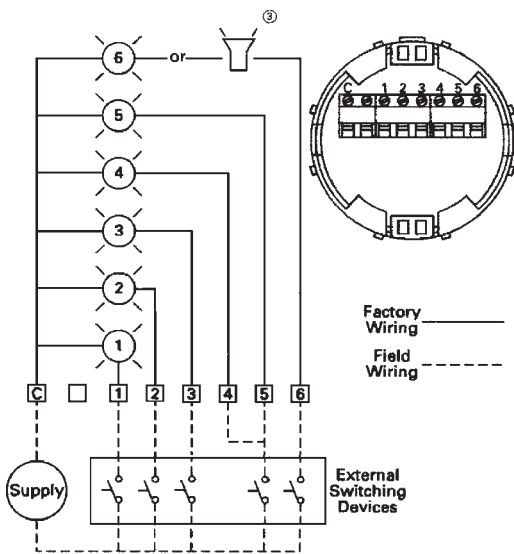

Flashing base

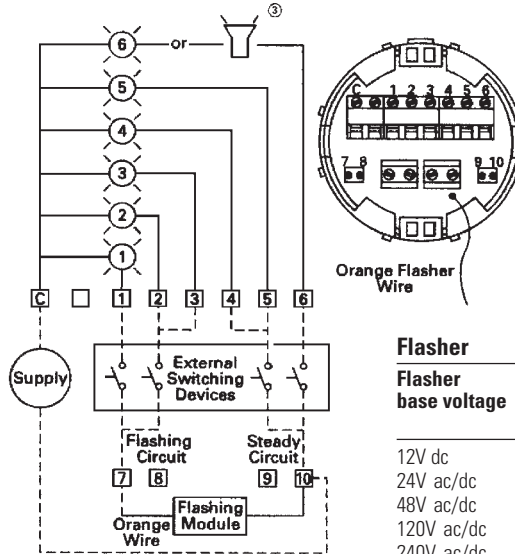





Flasher

Flasher base voltage	Max. Allowable no. of light modules
12V dc	2
24V ac/dc	4
48V ac/dc	6
120V ac/dc	6
240V ac/dc	6

Notes

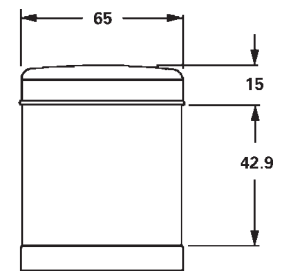
- ① Bases also suitable for mounting with extension tubes listed on page 51.
- ② Stacklight base and gasket are supplied as standard with two sets of base mount holes. One set with centre-to-centre spacing of 44.5 mm and another set with centre-to-centre spacing of 42 mm.
- ③ Audible alarm units must be wired via the steady circuit on flashing base units.
- √ Bases are supplied with top cover.

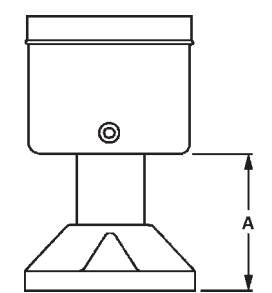
Accessories (continued)

	Description	Voltage	Catalogue numbers	Approximate dimensions (mm)
	Audible alarms – IP20 Volume adjustment range: 64 dB to 90 dB typical current draw (mA):			
	Mono-tonal			
	4.5 mA	12V ac/dc	E26BQV1	
	12.6 mA	24V ac/dc	E26BQV2	
	9.4 mA	48V ac/dc	E26BQV3	
	11.5 mA	120V ac/dc	E26BQV4	
	5.1 mA	240V ac/dc	E26BQV5	
	Bi-Tonal			
	4.5 mA	12V ac/dc	E26BNV1	
	12.6 mA	24V ac/dc	E26BNV2	
	9.4 mA	48V ac/dc	E26BNV3	
	11.5 mA	120V ac/dc	E26BNV4	
	5.1 mA	240V ac/dc	E26BNV5	
	Intermittent			
	4.5 mA	12V ac/dc	E26BPV1	
12.6 mA	24V ac/dc	E26BPV2		
9.4 mA	48V ac/dc	E26BPV3		
11.5 mA	120V ac/dc	E26BPV4		
5.1 mA	240V ac/dc	E26BPV5		
	Extension tubes – Black anodised aluminium For use with standard mounting base or 3/4" NPT threaded hub –			
	Extension "A":			
	20 mm extension	–	E26BHA	
	160 mm extension	–	E26BJA	
	360 mm extension	–	E26BKA	
760 mm extension	–	E26BMA		
	Mounting bases			Assembled dimensions (mm)
	Standard 3-hole mounting base	–	E26S108	
	Standard 4-hole mounting base			Tube extension
	–	–	E26S109	Height A
				20
				45
				160
				185
				360
				385
				760
				785

E26 Series - Accessories

Accessories (continued)

Description	Notes	Diagram	Catalogue numbers
Replacement mounting gasket	Normally included with Stacklight base	9	E26S105
Replacement lens O-ring	Normally included with light modules	2	E26S106
Replacement extension tube O-rings	Normally included with extension tubes	6	E26S107
Replacement cover	Normally included with Stacklight base	1	E26S68
Replacement lamps	12V 24V 48V 120V 240V	5	E26S8 E26S9 E26S10 E26S11 E26S12
Replacement Xenon strobe dual high (Does not include lenses)	12V ac/dc 24V ac/dc 48V ac/dc 120V ac 240V ac	4	E26S33 E26S34 E26S35 E26S36 E26S37
Replacement lenses	Clear Red Green Yellow Blue Amber	3	E26S38 E26S39 E26S40 E26S41 E26S42 E26S43
Replacement diffusers	White – normally supplied with incandescent light modules	4	E26S31
	Clear – normally supplied with LED light modules	4	E26S32
Lamp removal tool	For E26 and E22 incandescent lamps		E22BA3

Typical Stacklight assemblies (exploded view)

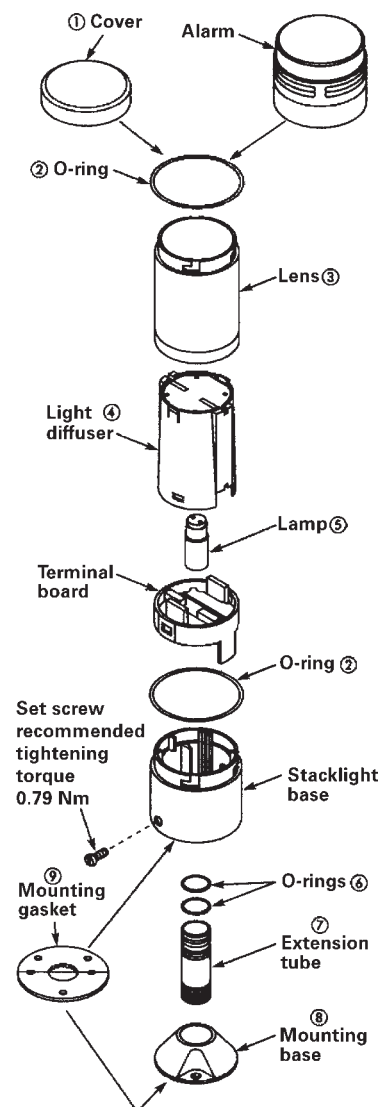

LEDs – Cluster or cylindrical

Voltage	Colour	Catalogue numbers		Cylindrical LEDs Steady Only
		Cluster LEDs Steady	Flashing	
12V ac/dc	Red	E26S15	E26S48	E26S110
	Green	E26S19	E26S53	E26S114
	Yellow	E26S23	E26S58	E26S112
	Blue	E26S27	E26S63	E26S115
	White	E26S71	E26S75	E26S116
	Amber	E26S79	E26S84	E26S111
24V ac/dc	Red	E26S16	E26S49	E26S117
	Green	E26S20	E26S54	E26S121
	Yellow	E26S24	E26S59	E26S119
	Blue	E26S28	E26S64	E26S122
	White	E26S72	E26S76	E26S123
	Amber	E26S80	E26S85	E26S118
48V ac/dc	Red	E26S17	E26S50	E26S124
	Green	E26S21	E26S55	E26S128
	Yellow	E26S25	E26S60	E26S126
	Blue	E26S29	E26S65	E26S129
	White	E26S73	E26S77	E26S130
	Amber	E26S81	E26S86	E26S125
120V ac/dc	Red	E26S18	E26S51	E26S138
	Green	E26S22	E26S56	E26S142
	Yellow	E26S26	E26S61	E26S140
	Blue	E26S30	E26S66	E26S143
	White	E26S74	E26S78	–
	Amber	E26S82	E26S87	E26S139
240V ac/dc	Red	E26S44	E26S52	–
	Green	E26S45	E26S57	–
	Yellow	E26S46	E26S62	–
	Blue	E26S47	E26S67	–
	White	E26S101	E26S102	–
	Amber	E26S83	E26S88	–

E26 Series - Technical and application data

Technical data

Standards and certifications

CE 60947-5-1
UL 508 – file #E131568
cUL C22.2 No. 14 – file #E131568

Ingress protection

Stacklight base and light units: IP65, NEMA 4, 4X and 13
Alarm units: IP20, NEMA 1

Electrical shock protection

Stacklight base and light unit: IP2X
Alarm units: IPOX

Mechanical ratings

Shock (IEC 68-2-27): 11 mS, 15g
Vibration (IEC 68-2-6): 10 sweeps 10 to 150 Hz, 2g
Bump (IEC 68-2-29): 1000 pulses, 6 mS, 15g

Climate conditions

Operating: maximum 40°C at 95% RH,
temperature –20° to 60°C
Storage: Temperature –40° to 80°C

Materials

Cover: Polycarbonate
Lenses: Polycarbonate
Stacklight base: Nylon
Extension tubes: Aluminium
Mounting base: Zinc die cast

Terminals

2.5 – 0.05 mm² for single conductors and 0.75 – 0.14 mm²
for two conductors of the same size. Do not mix solid and
stranded wire in the same terminal.
Recommended tightening torque is 0.5 – 0.6 Nm.

Electrical ratings

Insulation voltage (Ui): 690V
Operational voltage (Ue): 250V
Impulse withstand voltage (Uimp): 1.5 kV

Bulb specifications

Incandescent lamp type: BA15d
Maximum lamp wattage: 6W
Bulbs – average life:
Incandescent: 7,000 to 12,000 hrs.
Xenon flasher: 20,000 hrs.
LED: 60,000 to 100,000 hrs.

LED/Incandescent comparison

Incandescent lamps

Average operating life of 7,000 hours
Each lamp can be used with any colour lens
Low cost results in short term savings

LED lamps

Average operating life of 100,000 hours
Low power consumption
Extended life results in long-term savings

Application data

E26 Stacklight incandescent lamps

Type of light	Lamp used	Approximate current, mA per light	Theoretical lamp life, hours as applied
12V	BA15d	417	7,000
24V	BA15d	208	7,000
48V	BA15d	104	7,000
110 – 140V	BA15d	36 – 50	7,000
220 – 260V	BA15d	23 – 27	12,000

E26 Xenon flasher

Model	Voltage	Current (cont.)	Lamp life
12V	DC	460 mA	20,000
	AC	780 mA	20,000
24V Strobe	DC	190 mA	20,000
	AC	320 mA	20,000
48V	DC	100 mA	20,000
	AC	150 mA	20,000
120V	AC	60 mA ①	20,000
240V	AC	30 mA ①	20,000

① Represents average current draw, 1.6A peak for 120V and 0.8 peak at 240V.

E26 Continuous/flashing Stacklight LED

Type of light	Colour	Cluster LED Approximate current, mA at rated volts	Cylindrical LED Approximate current, mA at rated volts	Theoretical lamp life, hours as applied
12V ac/dc	Red	92	92	100,000
	Amber	92	92	100,000
	Yellow	92	92	100,000
	Green	60	60	80,000
	Blue	60	60	60,000
	White	60	60	60,000
24V ac/dc	Red	47	47	100,000
	Amber	47	47	100,000
	Yellow	47	47	100,000
	Green	59	59	80,000
	Blue	59	59	60,000
	White	59	59	60,000
48V ac/dc	Red	25	25	100,000
	Amber	25	25	100,000
	Yellow	25	25	100,000
	Green	18	18	80,000
	Blue	31	31	60,000
	White	31	31	60,000
60V ac/dc	Red	25	25	100,000
	Amber	25	25	100,000
	Yellow	25	25	100,000
	Green	18	18	80,000
	Blue	17	17	60,000
	White	17	17	60,000
120V ac/dc	Red	24	24	100,000
	Amber	24	24	100,000
	Yellow	24	24	100,000
	Green	17	17	80,000
	Blue	16	16	60,000
	White	16	16	60,000

Note:

Published theoretical lamp lives are based on ideal laboratory conditions and should be used for comparison only. Actual life may be shorter due to various application conditions.

Mounting options and dimensions (mm)

Stacklight bases may be mounted without the use of extension tube or mounting base. If additional height is required, choose 20 to 760 mm extension tubes that fit between the mounting base and the

Stacklight base. The extension tubes are threaded with 3/4" NPT threads, allowing for direct connection to conduit fittings or threaded holes without the use of a mounting base.

Base mounting

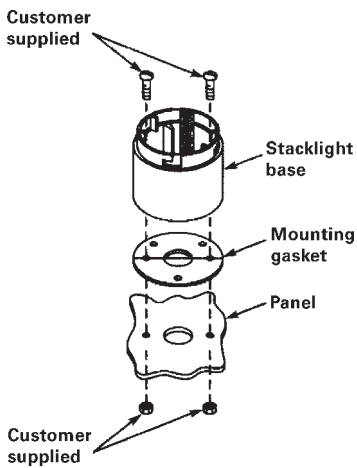

Utilising extension tube and mounting base

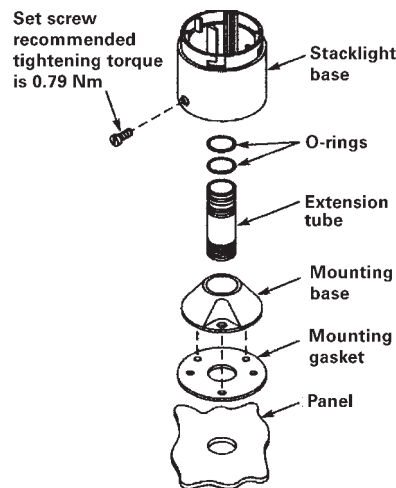

Base mounting

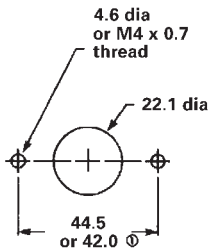

3-hole mounting for E26S108

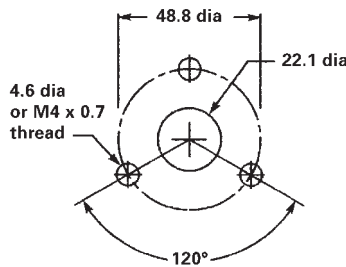

4-hole mounting for E26S109

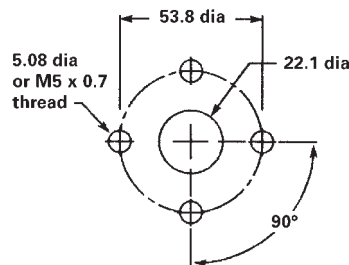

Note

- ① Stacklight base and gasket are supplied as standard with two sets of base mount holes. One set with centre-to-centre spacing of 44.5 mm and another set with centre-to-centre spacing of 42 mm.

E26 Series - Dimensions

Approximate dimensions (mm)

One-light unit Stacklight

Standard

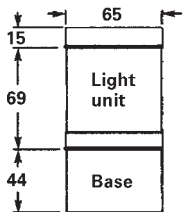

With alarm

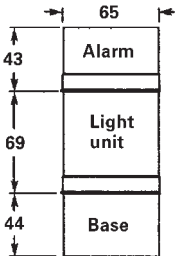

With Xenon flasher

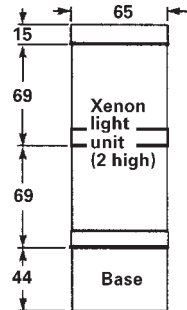

Light modules

Standard

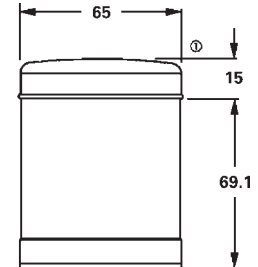

Xenon

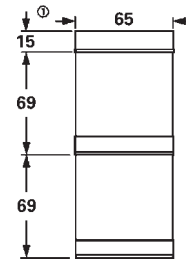

Note

① Cover included with Stacklight base.

Two-light unit Stacklight

Standard

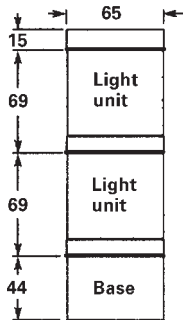

With alarm

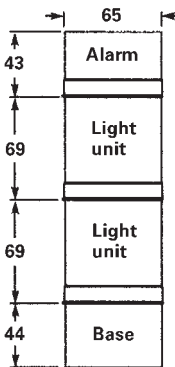

With Xenon flasher

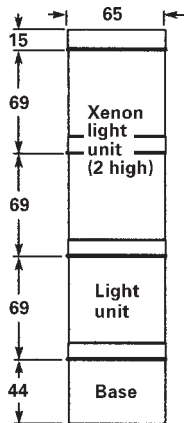

Three-light unit Stacklight

Standard

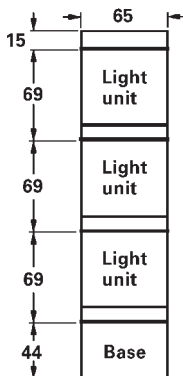

With alarm

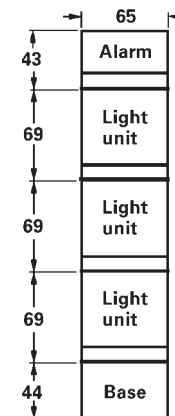

With Xenon flasher

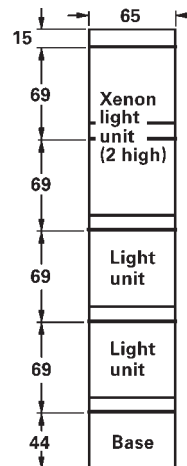

Eaton's Electrical business is a global leader in electrical control, power distribution, and industrial automation products and services. Through advanced product development, world-class manufacturing methods, and global engineering services and support, Eaton's Electrical business provides customer-driven solutions under brand names such as Cutler-Hammer®, Durant®, Heinemann®, Holec® and MEM®, which globally serve the changing needs of the industrial, utility, light commercial, residential, and OEM markets. For more information, visit www.EatonElectrical.com.

Eaton Corporation is a diversified industrial manufacturer with 2003 sales of \$8.1 billion. Eaton is a global leader in fluid power systems and services for industrial, mobile and aircraft equipment; electrical systems and components for power quality, distribution and control; automotive engine air management systems and powertrain controls for fuel economy; and intelligent drivetrain systems for fuel economy and safety in trucks. Eaton has 55,000 employees and sells products to customers in more than 100 countries. For more information, visit www.eaton.com.

Eaton Electric Limited

Reddings Lane
Birmingham B11 3EZ
United Kingdom

Customer Support Centre

Tel: +44 (0)8700 545 333
Fax: +44 (0)8700 540 333
email: ukcommorders@eaton.com

Eaton Electric NV

PO Box 23
7550 AA Hengelo
The Netherlands

Customer Support Centre

Tel: +31 (0)74 246 7066
Fax: +31 (0)74 246 7070
email: c-heuropesupport@eaton.com

