

The AR22 now uses a release arm with a wedge mechanism developed by Fuji Electric FA. This enables you to mount or remove the operator and contact block without using any tools. When fitting the switch to a panel, you can ignore the panel thickness.

You have only to secure the operator with a locking nut from behind the panel without any need for adjustment. The improved locking nut is capable of mounting the operator in both 22.3mm and 25.5mm dia. panel cutout holes.

■ Features

Facilitated mounting

- No adjusting of panel thickness is necessary.
- The button and lens can be mounted on a panel while the operator is engaged.
- Mountable even on a panel cutout 25.5mm in diameter.

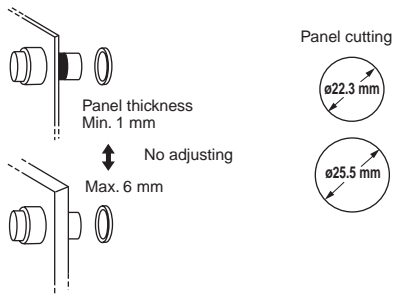

Miniaturization

- Pushbuttons and selector switches with 1NO+1NC: 41mm deep
- Pilot lights: 37mm deep
- The transformer now occupies far less space.

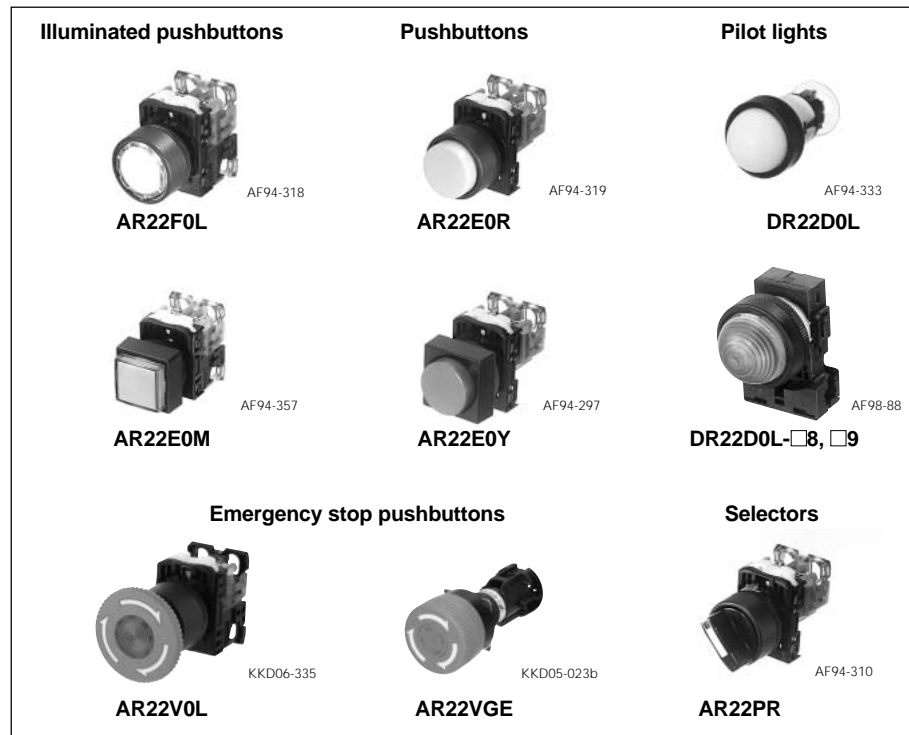
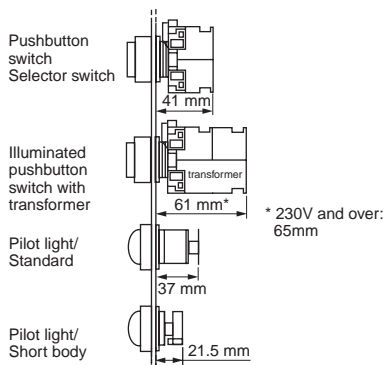

Easy replacing contact block and transformer

- Because of a snap-on mounting, replacement or addition of the contact block and transformer unit is very simple.
- The contact block is common to all the pushbuttons of this series.
- Contact block is easily replaced even when the pushbuttons are mounted closely together.
- Replacement of the contact block can be done with a screwdriver, without the need for any special tool.

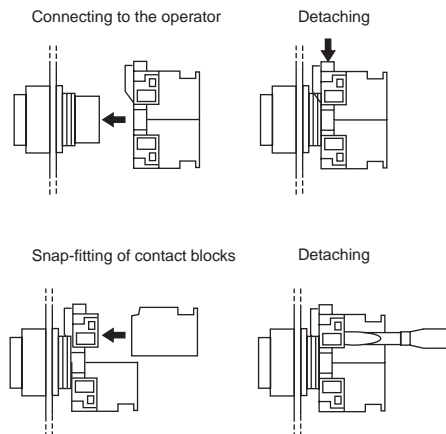

Wiring

- Wiring from two directions is possible.
- Wiring in both vertical and lateral directions facilitates wiring in narrow spaces.
- Color coding of contact blocks makes wiring easy. 1NO: Blue, 1NC: Red
- Lamp terminal and transformer unit: Black

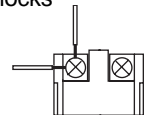

Safety

- A terminal cover is provided, assuring safety and security.
- FUJI's original Trigger Action mechanism is used in the emergency stop pushbuttons. They are suitable for emergency stop and safety. This mechanism prevents the contacts from moving until the button is pushed and locked.
- Reliability of safety functions increased by integrated operator and contact block construction. (AR22VG)

Protection

- Excellent oil-tight construction (IP65) of the operator.
- Closure of the contact block has been improved.

■ Approvals





For further information related to approved type, see page 04/3 to 04/06.

Pushbuttons/Selectors/Pilot Lights/Buzzers







AR22 and DR22

Quick reference guide

■ Illuminated pushbutton switches

Operator	Type	Operator	Type	Operator	Type
Flush round head <i>See page 04/17, 04/40</i>	AR22F0L, F5L  AF94-318	Extended with full guard (24mm dia. with openings) <i>See page 04/17, 04/40</i>	AR22G2L, G7L  AF99-319	Flush round head with square bezel <i>See page 04/18, 04/40</i>	AR22F0P, F5P  AF94-315
Extended round head <i>See page 04/17, 04/40</i>	AR22E0L, E5L  AF94-317	Extended with full guard (24mm dia.) <i>See page 04/18, 04/40</i>	AR22G1L, G6L  AF02-70	Extended round head with square bezel <i>See page 04/18, 04/40</i>	AR22E0P, E5P  AF94-314
Mushroom head (40mm dia.) <i>See page 04/17, 04/40</i>	AR22M0L, M5L  AF94-367	Push-lock, turn-reset (40mm dia. with white arrow) <i>See page 04/18, 04/40</i>	AR22V5L  KKD06-335	Mushroom head with square bezel (29mm dia.) <i>See page 04/19, 04/40</i>	AR22M4P  AF94-440
Mushroom head (29mm dia.) <i>See page 04/17, 04/40</i>	AR22M4L, M9L  AF94-369	Flush square head <i>See page 04/18, 04/40</i>	AR22F0M, F5M  AF97-68		
Extended with transparent full guard (24mm dia.) <i>See page 04/17, 04/40</i>	AR22G4L, G9L  AF94-294	Extended square head <i>See page 04/18, 04/40</i>	AR22E0M, E5M  AF94-357		

■ Pushbutton switches

Operator	Type	Operator	Type	Operator	Type
Flush round head <i>See page 04/20, 04/41</i>	AR22F0R, F5R  AF94-320	Flush round head Symbol mark type <i>See page 04/20, 04/41</i>	AR22FAR, FBR  AF98-193	Mushroom head (40mm dia.) <i>See page 04/20, 04/41</i>	AR22M0R, M5R  AF94-293
Extended round head <i>See page 04/20, 04/41</i>	AR22E0R, E5R  AF94-319	Extended round head Symbol mark type <i>See page 04/20, 04/41</i>	AR22EAR, EBR  AF98-192	Mushroom head (29mm dia.) <i>See page 04/20, 04/41</i>	AR22M4R, M9R  AF94-321

Note (CCC) : *See page 04/289*

Pushbuttons/Selectors/Pilot Lights/Buzzers

AR22 and DR22

Quick reference guide

■ Pushbutton switches

Operator	Type	Operator	Type	Operator	Type
Extended with full guard (24mm dia.) <i>See page 04/20, 04/41</i> UL, CE, CCC	AR22G3R, G8R  AF94-292	Pushbutton with selector ring (2-position) <i>See page 04/22, 04/41</i> UL, CE, CCC	AR22S1R, S2R, S3R, S6R  AF97-507	Flush round head with square bezel <i>See page 04/20, 04/41</i> UL, CE, CCC	AR22F0Y, F5Y  AF94-295
Flush with full guard (24mm dia.) <i>See page 04/20, 04/41</i> UL, CE, CCC	AR22G2R, G7R  AF02-68	Push-lock, turn-reset (40mm dia. with white arrow) <i>See page 04/20, 04/41</i> UL, CE, CCC	AR22V5R  KKD08-042	Extended round head with square bezel <i>See page 04/21, 04/41</i> UL, CE, CCC	AR22E0Y, E5Y  AF94-297
Extended with half guard <i>See page 04/20, 04/41</i> UL, CE, CCC	AR22G0R, G5R  AF96-236	Flush square head <i>See page 04/20, 04/41</i> UL, CE, CCC	AR22F0S, F5S  AF94-316	Mushroom head with square bezel (29mm dia.) <i>See page 04/21, 04/41</i> UL, CE, CCC	AR22M4Y  AF94-298
Mushroom head with full guard (40mm dia.) <i>See page 04/20, 04/41</i> UL, CE, CCC	AR22M3R, M8R  AF94-372	Extended square head <i>See page 04/20, 04/41</i> UL, CE, CCC	AR22E0S, E5S  AF94-296		

Note: AR22M8R: Not approved standard

■ Emergency stop pushbutton switches (conform to EN418)

Operator	Type	Operator	Type	Operator	Type
Push-lock, turn-reset (Soft-touch 40mm dia. with white arrow) <i>See page 04/23, 04/42</i> UL, CE, CCC	AR22V0R  KKD08-042	Push-lock, turn-reset (29mm dia.) <i>See page 04/23, 04/42</i> UL, CE, CCC	AR22V4R  KKD06-339	Unibody push-lock, turn-reset (Soft-touch 40mm dia. with white arrow) <i>See page 04/23, 04/42</i> UL, CE, CCC	AR22VGE  KKD05-023b
Push-lock, turn-reset (40mm dia.) <i>See page 04/23, 04/42</i> UL, CE, CCC	AR22V2R  KKD05-020b	Key release push-lock, turn-reset (40mm dia.) <i>See page 04/23, 04/42</i> UL, CE, CCC	AR22V7R  KKD09-020	Push-lock, turn-reset (40mm dia. with "EMO" character) <i>See page 04/120</i> UL, CE	AR22V3R-EMO, ARZ286  KKD05-261
Push-lock, turn-reset (Soft-touch 29mm dia. with white arrow) <i>See page 04/23, 04/42</i> UL, CE, CCC	AR22VSR  KKD06-346	Push-lock, pull-reset (35mm dia.) <i>See page 04/23, 04/42</i> UL, CE, CCC	AR22Q2R  KKD06-334		







Notes: Provided with the  (Direct opening action)  : *See page 04/289*

Pushbuttons/Selectors/Pilot Lights/Buzzers

AR22 and DR22

Quick reference guide

■ Emergency stop illuminated pushbutton switches (conform to EN418)



Operator	Type	Operator	Type	Operator	Type
Push-lock, turn-reset (Soft-touch 40mm dia. with white arrow) <i>See page 04/24, 04/43</i>	AR22V0L  KKD06-335	Push-lock, turn-reset (Soft-touch 40mm dia. transparent in all colors with white arrow) <i>See page 04/24, 04/43</i>	AR22VDL  KKD06-342	Push-lock, turn-reset (Soft touch 29mm dia. with white arrow) <i>See page 04/24, 04/43</i>	AR22VSL  KKD06-344
Push-lock, turn-reset (40mm dia.) <i>See page 04/24, 04/43</i>	AR22V2L  KKD06-337	Push-lock, turn-reset (40mm dia. transparent in all colors) <i>See page 04/24, 04/43</i>	AR22VAL  KKD06-340	Unibody push-lock, turn-reset (Soft-touch 40mm dia. with white arrow) <i>See page 04/24, 04/43</i>	AR22VGF  KKD05-150

Note: Provided with the  (Direct opening action)

■ Selector switches

Operator	Type	Operator	Type	Operator	Type
Knob <i>See page 04/25, 04/44</i>	AR22PR, PCR  AF94-310	Key <i>See page 04/25, 04/44</i>	AR22JR, JCR  KKD09-018	Lever with square bezel <i>See page 04/25, 04/44</i>	AR22WY, WCY  AF94-323
Lever <i>See page 04/25, 04/44</i>	AR22WR, WCR  AF94-324	Key (Long durability) <i>See page 04/25, 04/44</i>	AR22JAR  KKD09-015	Cylindrical knob with square bezel <i>See page 04/25, 04/44</i>	AR22RY, RCY  AF94-362
Cylindrical knob <i>See page 04/25, 04/44</i>	AR22RR, RCR  AF94-308	Knob with square bezel <i>See page 04/25, 04/44</i>	AR22PY, PCY  AF94-309	Key with square bezel <i>See page 04/25, 04/44</i>	AR22JY, JCY  KKD09-019

■ Illuminated selector switches

Operator	Type	Operator	Type
Knob <i>See page 04/32, 04/45</i>	AR22PL  AF94-306	Knob with square bezel <i>See page 04/32, 04/45</i>	AR22PP  AF94-318

Note  : *See page 04/289*

Pushbuttons/Selectors/Pilot Lights/Buzzers

AR22 and DR22







Quick reference guide

■ Pilot lights





Lens	Type	Lens	Type	Lens	Type
Dome	DR22D0L  AF94-333	Flush square	DR22F3M  AF94-330	Extended square	DR22E3M  AF94-380
<i>See page 04/34, 04/45</i>		<i>See page 04/34, 04/47</i>		<i>See page 04/34, 04/46</i>	
					
Extended round	DR22E3L  AF94-332	Flush square (Transparent lens)	DR22F4M  AF94-443	Flush rectangular	DR22E3N  AF96-237
<i>See page 04/34, 04/46</i>		<i>See page 04/34, 04/47</i>		<i>See page 04/34, 04/48</i>	
					
Faceted	DR22K0L  AF96-189	Flush square (12mm high frame)	DR22F5M  AF95-658	Extended round with square bezel	DR22E3P  AF94-331
<i>See page 04/34, 04/46</i>		<i>See page 04/34, 04/47</i>		<i>See page 04/34, 04/46</i>	
					

Note: With resistor unit type: Not approved standard

■ Joy stick selector switches

Handle	Type	Handle	Type	Handle	Type
Ball type	AR22A0, A5  AF97-49	Ball type with lock	AR22A1, A6  AF97-45	Rubber cap type	AR22A2, A7  AF97-56
<i>See page 04/38, 04/48</i>		<i>See page 04/38, 04/48</i>		<i>See page 04/38, 04/49</i>	
					

■ Buzzers

Sound	Type	Sound	Type	Sound	Type
Electronic sound	DR22B5 *  KKD08-053	Magnetic sound	DR22B3  AF96-376	Electronic sound (IP54)	DR22B8 *  AF96-244
<i>See page 04/39, 04/49</i>		<i>See page 04/39, 04/49</i>		<i>See page 04/39, 04/49</i>	
					

Note: * 6V AC, 110V DC types: Not approved standard

Note (CC): See page 04/289

Illuminated pushbuttons

AR22 E0L – 10 E3 R □

① ② ③ ④ ⑤ ⑥

① **Product category**

AR22: 22mm-dia. illuminated pushbutton
 22mm-dia. emergency stop illuminated pushbutton

② **Operator**

- Illuminated pushbutton
- F0L: Flush round head
- F5L: Flush round head (Alternate)
- E0L: Extended round head
- E5L: Extended round head (Alternate)
- M0L: Mushroom head (40mm dia.)
- M5L: Mushroom head (40mm dia. alternate)
- M4L: Mushroom head (29mm dia.)
- M9L: Mushroom head (29mm dia. alternate)
- G4L: Extended with transparent full guard (24mm dia.)
- G9L: Extended with transparent full guard (24mm dia. alternate)
- G2L: Extended with full guard (24mm dia. with openings)
- G7L: Extended with full guard (24mm dia. with openings, alternate)
- G1L: Extended with full guard (24mm dia.)
- G6L: Extended with full guard (24mm dia. alternate)
- V5L: Push-lock, turn-reset (40mm dia. with white arrow) *1
- F0M: Flush square head
- F5M: Flush square head (Alternate)
- E0M: Extended square head
- E5M: Extended square head (Alternate)
- F0P: Flush round head with square bezel
- F5P: Flush round head with square bezel (Alternate)
- E0P: Extended round head with square bezel
- E5P: Extended round head with square bezel (Alternate)
- M4P: Mushroom head with square bezel (29mm dia.)
- Emergency stop illuminated pushbutton
- V0L: Push-lock, turn-reset (Soft-touch 40mm dia. with white arrow)
- V2L: Push-lock, turn-reset (40mm dia.)
- VDL: Push-lock, turn-reset (Soft-touch 40mm dia. transparent in all colors with white arrow)
- VAL: Push-lock, turn-reset (40mm dia. transparent in all colors)
- VSL: Push-lock, turn-reset (Soft-touch 29mm dia. with white arrow)
- VGF: Unibody push-lock, turn-reset (Soft-touch 40mm dia. with white arrow)

③ **Contact arrangement**

- | | |
|-------------|---------|
| 10: 1NO | 30: 3NO |
| 01: 1NC | 03: 3NC |
| 11: 1NO+1NC | 40: 4NO |
| 20: 2NO | 04: 4NC |
| 02: 2NC | 50: 5NO |
| 22: 2NO+2NC | 05: 5NC |

④ **Lamp voltage**

- Incandescent lamp
- 54: 5.5V AC/DC, without transformer
- C4: 15V AC/DC, without transformer
- D4: 20V AC/DC, without transformer
- E4: 24V AC/DC, without transformer
- H4: 100-110V AC, with transformer
- L4: 115-127V AC, with transformer
- M4: 200-220V AC, with transformer
- Q4: 230-254V AC, with transformer
- S4: 350-380V AC, with transformer
- T4: 400-440V AC, with transformer
- V4: 480V AC, with transformer
- W4: 500-550V AC, with transformer
- LED lamp
- A3: 6V AC, without transformer
- 63: 6V DC, without transformer
- B3: 12V AC/DC, without transformer
- C3: 15V AC/DC, without transformer
- E3: 24V AC/DC, without transformer
- H3: 100-110V AC, with transformer
- L3: 115-127V AC, with transformer
- M3: 200-220V AC, with transformer
- Q3: 230-254V AC, with transformer
- S3: 350-380V AC, with transformer
- T3: 400-440V AC, with transformer
- V3: 480V AC, with transformer
- W3: 500-550V AC, with transformer

- Neon lamp (For AR22VGF)
- H1: 110V AC, without transformer
- K1: 120V AC, without transformer
- M1: 220V AC, without transformer
- P1: 240V AC, without transformer

⑤ **Color of lens**

- | | |
|-----------|-----------|
| G: Green | Y: Yellow |
| R: Red *2 | A: Orange |
| W: White | S: Blue |

⑥ **Special product**

- Z9: Resisting water-soluble cutting oils and heat
- Z8: With a contact protection cover
- Z4: Resisting sulfuration gas
- ZB: Meeting IP2X finger-protection standards

Notes: *1 Products with no trigger action mechanism. These products cannot be used as emergency stop switches that comply with EN standards.



- *2 Button color of emergency stop illuminated switches are Red only.
- The manufacturing range varies depending on the model. For details, refer to the contents of this catalog.

Pushbuttons/Selectors/Pilot Lights/Buzzers

AR22 and DR22

Type number nomenclature

Pushbuttons

AR22 E0R – 10 R  

① ② ③ ④ ⑤ ⑥

① Product category

AR22: 22mm-dia. pushbutton
22mm-dia. emergency stop pushbutton

② Operator

- Pushbutton switch
- F0R: Flush round head
- F5R: Flush round head (Alternate)
- E0R: Extended round head
- E5R: Extended round head (Alternate)
- FAR: Flush round head (Symbol mark type)
- FBR: Flush round head (Symbol mark type, alternate)
- EAR: Extended round head (Symbol mark type)
- EBR: Extended round head (Symbol mark type, alternate)
- M0R: Mushroom head (40mm dia.)
- M5R: Mushroom head (40mm dia. Alternate)
- M4R: Mushroom head (29mm dia.)
- M9R: Mushroom head (29mm dia. Alternate)
- G3R: Extended with full guard (24mm dia.)
- G8R: Extended with full guard (24mm dia. Alternate)
- G2R: Flush with full guard (24mm dia.)
- G7R: Flush with full guard (24mm dia. Alternate)
- G0R: Extended with half guard
- G5R: Extended with half guard (Alternate)
- M3R: Mushroom head with full guard (40mm dia.)
- M8R: Mushroom head with full guard (40mm dia. Alternate)
- S1R: Push-button with selector ring (2-position)
- S2R: Push-button with selector ring (2-position)
- S3R: Push-button with selector ring (2-position)
- S6R: Push-button with selector ring (2-position)
- V5R: Push-lock, turn-reset (40mm dia. with white arrow) *1
- F0S: Flush square head
- F5S: Flush square head (Alternate)
- E0S: Extended square head
- E5S: Extended square head (Alternate)
- F0Y: Flush round head with square bezel
- F5Y: Flush round head with square bezel (Alternate)
- E0Y: Extended round head with square bezel
- E5Y: Extended round head with square bezel (Alternate)
- M4Y: Mushroom head with square bezel (29mm dia.)
 - Emergency stop pushbutton switch
- V0R: Push-lock, turn-reset (Soft-touch 40mm dia. with white arrow)
- V2R: Push-lock, turn-reset (40mm dia.)
- VSR: Push-lock, turn-reset (Soft-touch 29mm dia. with white arrow)
- V4R: Push-lock, turn-reset (29mm dia.)
- V7R: Key-release push-lock, turn-reset (40mm dia.)
- Q2R: Push-lock, pull-reset (35mm dia.)
- VGE: Unibody push-lock, turn-reset (Soft-touch 40mm dia. with white arrow)

③ Contact arrangement

10: 1NO 30: 3NO
01: 1NC 03: 3NC
11: 1NO+1NC 33: 3NO+3NC
20: 2NO 40: 4NO
02: 2NC 04: 4NC
22: 2NO+2NC 50: 5NO
 05: 5NC

④ Color of button

G: Green Y: Yellow
R: Red² A: Orange
B: Black S: Blue
W: White C: Clear
T: Green, Red, Black (For AR22F0R) (For AR22FAR, FBR, EAR, EBR)

⑤ Symbol mark (For AR22FAR, FBR, EAR, EBR)

Symbol mark	○	I	Ⓢ	○	I	Ⓢ	
Color of button	White	Black	White	Black	White	Black	Clear
Color of mark	Red		Green		Green		Black
Code	01	02	03	04	11	12	02B 04B 12B

⑥ Special product

Z9: Resisting water-soluble cutting oils and heat
Z8: With a contact protection cover
Z4: Resisting sulfuration gas
ZB: Meeting IP2X finger-protection standards

Notes: *1 Products with no trigger action mechanism. These products cannot be used as emergency stop switches that comply with EN standards.

*2 Button color of emergency stop switches are Red only.

• The manufacturing range varies depending on the model. For details, refer to the contents of this catalog.

Selector and illuminated selector switches

AR22 PL – 2 □ **10 E3 G** □ □
 ① ② ③ ④ ⑤ ⑥ ⑦ ⑧ ⑨

① **Product category**

AR22: 22mm dia. selector switch and illuminated selector switch

② **Operator**

- Selector switch
 - PR: Knob
 - PCR: Knob operated control type
 - WR: Lever
 - WCR: Lever operated control type
 - RR: Cylindrical knob
 - RCR: Cylindrical knob operated control type
 - JR: Key
 - JCR: Key operated control type
 - JAR: Key (Long durability)
 - PY: Knob with square bezel
 - PCY: Knob operated control type with square bezel
 - WY: Lever with square bezel
 - WCY: Lever operated control type with square bezel
 - RY: Cylindrical knob with square bezel
 - RCY: Cylindrical knob operated control type with square bezel
 - JY: Key with square bezel
 - JCY: Key operated control type with square bezel
- Illuminated selector switch
 - PL: Knob
 - PP: Knob with square bezel

③ **Operation**

- 2: 2-position, maintained
- 0: 2-position, spring return
- 3: 3-position, maintained
- 6: 3-position, spring/manual return (Left to center)
- 7: 3-position, spring/manual return (Right to center)
- 1: 3-position, spring return
- 4: 4-position, maintained (For AR22PCR, WCR, RCR)
- 5: 5-position, maintained (For AR22PCR, WCR, RCR)

④ **Key removable position**

- A: Left
- B: Left and right
- C: Left, right and center
- D: Right
- E: Center
- F: Right and center
- G: Left and center

⑤ **Contact arrangement**

- | | |
|-------------|-------------|
| 10: 1NO | 30: 3NO |
| 01: 1NC | 03: 3NC |
| 11: 1NO+1NC | 33: 3NO+3NC |
| 20: 2NO | 40: 4NO |
| 02: 2NC | 04: 4NC |
| 22: 2NO+2NC | 50: 5NO |
| | 05: 5NC |

Note: Control type: See page 04/29 to 04/31

⑥ **Lamp voltage**

- Incandescent lamp
 - 54: 5.5V AC/DC, without transformer
 - C4: 15V AC/DC, without transformer
 - D4: 20V AC/DC, without transformer
 - E4: 24V AC/DC, without transformer
 - H4: 100-110V AC, with transformer
 - L4: 115-127V AC, with transformer
 - M4: 200-220V AC, with transformer
 - Q4: 230-254V AC, with transformer
 - S4: 350-380V AC, with transformer
 - T4: 400-440V AC, with transformer
 - V4: 480V AC, with transformer
 - W4: 500-550V AC, with transformer
- LED lamp
 - A3: 6V AC, without transformer
 - 63: 6V DC, without transformer
 - B3: 12V AC/DC, without transformer
 - C3: 15V AC/DC, without transformer
 - E3: 24V AC/DC, without transformer
 - H3: 100-110V AC, with transformer
 - L3: 115-127V AC, with transformer
 - M3: 200-220V AC, with transformer
 - Q3: 230-254V AC, with transformer
 - S3: 350-380V AC, with transformer
 - T3: 400-440V AC, with transformer
 - V3: 480V AC, with transformer
 - W3: 500-550V AC, with transformer

⑦ **Color of knob**

- B: Black (Not available for illuminated selector switch)
- G: Green
- R: Red
- W: White (Not available for selector switch)
- Y: Yellow (Not available for selector switch)
- A: Orange (Not available for selector switch)
- S: Blue (Not available for selector switch)

⑧ **Key type No.**

- A, B, C, D, E or F
- ("A" is standard)

⑨ **Special product**

- Z9: Resisting water-soluble cutting oils and heat
- Z8: With a contact protection cover
- Z4: Resisting sulfuration gas
- ZB: Meeting IP2X finger-protection standards

Note: • The manufacturing range varies depending on the model. For details, refer to the contents of this catalog.

AR22 and DR22

Type number nomenclature

Pilot lights

DR22 D0L – E3 W □

① ② ③ ④ ⑤

① Product category

DR22: 22mm dia. pilot light

② Lens

D0L: Dome

E3L: Extended round

K0L: Faceted

F3M: Flush square

F4M: Flush square (Transparent lens)

F5M: Flush square (12mm high frame)

E3M: Extended square

E3N: Flush rectangular

E3P: Extended round with square bezel

③ Lamp voltage

• Incandescent lamp

54: 5.5V AC/DC, without transformer

C4: 15V AC/DC, without transformer

D4: 20V AC/DC, without transformer

E4: 24V AC/DC, without transformer

H4: 100-110V AC, with transformer

L4: 115-127V AC, with transformer

M4: 200-220V AC, with transformer

Q4: 230-254V AC, with transformer

S4: 350-380V AC, with transformer

T4: 400-440V AC, with transformer

V4: 480V AC, with transformer

W4: 500-550V AC, with transformer

• LED lamp

A3: 6V AC, without transformer

63: 6V DC, without transformer

B3: 12V AC/DC, without transformer

C3: 15V AC/DC, without transformer

E3: 24V AC/DC, without transformer

H3: 100-110V AC, with transformer

L3: 115-127V AC, with transformer

M3: 200-220V AC, with transformer

Q3: 230-254V AC, with transformer

S3: 350-380V AC, with transformer

T3: 400-440V AC, with transformer

V3: 480V AC, with transformer

W3: 500-550V AC, with transformer

H7: 110V DC, with resistor unit

58: 5.5V AC/DC, short-body without transformer

C8: 15V AC/DC, short-body without transformer

D8: 20V AC/DC, short-body without transformer

E8: 24V AC/DC, short-body without transformer

H8: 100-110V AC, short-body with transformer

L8: 115-127V AC, short-body with transformer

M8: 200-220V AC, short-body with transformer

A9: 6V AC, short-body without transformer

69: 6V DC, short-body without transformer

B9: 12V AC/DC, short-body without transformer

C9: 15V AC/DC, short-body without transformer

E9: 24V AC/DC, short-body without transformer

H9: 100-110V AC, short-body with transformer

L9: 115-127V AC, short-body with transformer

M9: 200-220V AC, short-body with transformer

④ Color of lens

G: Green

Y: Yellow

R: Red

A: Orange

W: White

S: Blue

⑤ Special product

Z9: Resisting water-soluble cutting oils and heat

Z4: Resisting sulfuration gas

ZB: Meeting IP2X finger-protection standards

Note: • The manufacturing range varies depending on the model. For details, refer to the contents of this catalog.

Joy stick selector switches

AR22A 0 N – A0A0 B

① ②③ ④ ⑤

① **Product category**

AR22A: 22mm-dia. Joy stick selector switch

② **Handle**

- 0: Ball type (without lock, manual return)
- 1: Ball type with lock (manual return)
- 2: Rubber cap type (without lock, manual return)
- 5: Ball type (without lock, spring return)
- 6: Ball type with lock (spring return)
- 7: Rubber cap type (without lock, spring return)

③ **Terminal**

- N: Screw
- H: Solder/tab

④ **Contact arrangement**

Contact arrangement	Blank	1NO	1NC	1NO+1NC	2NO	2NC	2NO+2NC
Code	Screw	0	A	B	1	D	E
	Solder/tab	0	-	-	1	-	2

Operating direction code of contacts

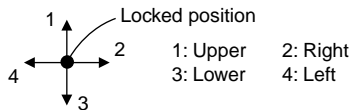

Ex. AR22A0N-A 0 A 0 B
1 2 3 4

⑤ **Handle color**

- B: Black

■ **Ordering information**

Specify the following:

1. Type number

For the CCC approved product, add the suffix **(CCC)** to the type number

Example: Pushbutton switch **AR22F0R-11B(CCC)**

Buzzers

DR22B 5 – E B

① ② ③ ④

① **Product category**

DR22B: 22mm-dia. buzzer

② **Sound**

- 5: Electronic sound
- 3: Magnetic sound
- 8: Electronic sound (IP54)

③ **Operating voltage**

- A: 6V AC (Type “5”, “8”)
- 6: 6V DC (Type “5”, “8”)
- E: 12-24V AC/DC (Type “3” : 24V AC/DC)
- F: 35-48V AC/DC (Type “5”, “8”)
- H: 100-110V AC
- M: 200-220V AC
- 1: 100-110V DC (Type “5”, “8”)

④ **Color of head**

- B: Black

Pushbuttons/Selectors/Pilot Lights/Buzzers

AR22 and DR22

Ratings and specifications

■ Standards approved

UL508	File No. E44592
CSA C22.2 No.14	File No. LR20479 cUL File No. E44592 (For AR22VG)
TÜV: EN60947-5-1	Pushbutton, Illuminated pushbutton: R9551062, Selector, Illuminated selector: R9551060 Pilot lights: R9551061 Joy stick selector switch: R2050803 (Lever switch) Buzzer: J9950091
TÜV: EN60947-5-1 EN60947-5-5	Emergency stop pushbutton Emergency stop illuminated pushbutton : R50028146, R50028137 (For AR22VG)

■ Specifications (Indoor use)

Description	Pushbutton switch Illuminated pushbutton switch Emergency stop pushbutton switch Emergency stop illuminated pushbutton switch Selector switch Illuminated selector switch	Joy stick selector (Lever switch)	Pilot light
Rated insulation voltage	600V AC/DC *1	250V AC/DC	250V AC/DC *2
Mechanical durability	See page 04/13	250,000 operations	–
Electrical durability	500,000 operations at 220V AC 6A 1 million operations at 220V AC 3A (AR22VG type: 100,000 operations)	100,000 operations at 220V AC 1A (Res. load)	–
Operating frequency	1200 operations/hour (On-load factor: 40%) AR22VG type: 1800 operations/hour (On-load factor: 40%)		–
Dielectric strength	2500V AC, 1 minute *3	2000V AC, 1 minute *4	
Insulation resistance	100MΩ or more (500V DC megger)		
Rated impulse dielectric strength	6kV (AR22VG type: 4kV)	–	6kV
Conditional short-circuit current	1000A	1000A	–
Short-circuit protective device	Fuse 15A	Fuse 1A	–
Pollution degree	3		
Vibration	Resonance: 10 to 55Hz, double amplitude 0.1mm *5 Constant: 16.7Hz, double amplitude 3mm		
Shock	Malfunction durability: 100m/s ² *6 Mechanical durability: 500m/s ²		Mechanical durability : 500m/s ²
Ambient temperature (No condensation or no icing)	-20 to +70°C *7	-5 to +70°C	-20 to +50°C
Storage temperature	-40 to +80°C		
Humidity	45 to 85% RH (within -5 to +40°C)		
Degree of protection	IP65		

Notes: *1 Illuminated type without transformer and AR22VG type: 250V AC/DC

*2 Pilot light with transformer: 600V AC

*3 Illuminated type without transformer: 2000V AC, 1 minute (except AR22VGF type)

*4 Pilot light with transformer: 2500V AC, 1 minute

*5 Emergency stop type: 10 to 500Hz, double amplitude 0.7mm (acceleration 50m/s²), according to the test condition of EN60947-5-5 (1997)

*6 Emergency stop type: 150m/s²

*7 AR22VGE type: -20 to +60°C, illuminated type: -20 to +50°C

Pushbuttons/Selectors/Pilot Lights/Buzzers AR22 and DR22 Ratings and specifications

04

● Mechanical durability

Description		Operations
Pushbutton switch	Momentary action	5 million
Illuminated pushbutton switch	Alternate action	1 million
Emergency stop pushbutton switch	With selector ring	100,000
Emergency stop illuminated pushbutton	Push-lock, turn-reset	100,000
	Push-lock, pull-reset	30,000
Selector switch	Maintained 1, 2, 3, 4-contact	1 million
	Maintained 5, 6-contact	500,000
	Control type, spring return, spring/manual return	200,000
Illuminated selector switch	Maintained	
	Without transformer 1, 2, 3-contact	1 million
	4-contact	500,000
	With transformer 1, 2-contact	1 million
	3-contact	500,000
	Spring return, spring/manual return	200,000

Note: Key insertion/removal durability for selector switch key types

- Key type 10,000
- Key (Long durability) type 20,000

● Buzzers

Item	DR22B5	DR22B3	DR22B8
Rated insulation voltage	Without transformer: 60V AC/DC With transformer: 250V AC		
Sound level	90dB (0.1m) 70dB (1m)	80 to 90dB (0.1m) 60 to 70dB (1m)	80dB (0.1m) 60dB (1.0m)
Durability	1000h	200h	1000h
Frequency	2.4 to 3.3kHz		
Intermittent cycle	Approx. 170-cycle/min		
Current consumption	See the table below		
Dielectric strength	Without transformer: 1000V AC 1 minute With transformer: 2000V AC 1 minute		
Insulation resistance	100MΩ or more (500V DC megger)		
Pollution degree	3		
Vibration	Resonance: 10 to 55Hz, double amplitude 0.1mm Constant: 16.7Hz, double amplitude 3.0mm		
Shock	Mechanical durability: 500m/s ²		
Ambient temperature	-20 to +60°C (No condensation or no icing) (with resistor unit: -20 to +40°C)		
Storage temperature	-30 to +70°C		
Humidity	45 to 85%RH (within -5 to 40°C)		
Degree of protection	IP00		IP54

● Current consumption

Operational voltage	Current consumption	
	DR22B5, DR22B8	DR22B3
6V AC	70mA AC	—
6V DC	35mA DC	—
24V AC/DC	40mA AC, 25mA DC	30mA AC, 20mA DC
48V AC/DC	65mA AC, 20mA DC	—
110V AC	30mA AC	30mA AC
110V DC	30mA DC	—
220V AC	15mA AC	15mA AC

Pushbuttons/Selectors/Pilot Lights/Buzzers

AR22 and DR22

Ratings and specifications

■ **Contact ratings**
 ● **UL/CSA standards**
AC (COS ϕ =0.35)

Contact rated code	120V		240V		480V		600V	
	Making current	Breaking current	Making current	Breaking current	Making current	Breaking current	Making current	Breaking current
A600	60A	6.0A	30A	3.0A	15A	1.5A	12A	1.2A
B300 (AR22VG)	30A	3.0A	15A	1.5A	–	–	–	–

DC $T_{0.95}$ = 6P (Max. 300ms)

Description	Contact rated code	Making current · Breaking current		
		125V	250V	301V–600V
Illuminated pushbutton switch Pushbutton (Ring type selector switch: AR22S2R only) Emergency stop pushbutton switch	P600	1.1A	0.55A	0.2A
Emergency stop illuminated pushbutton switch (Except the overlap contact types)	Q300 (AR22VG)	0.55A	0.27A	–
Overlap contact types of products shown above Pushbutton (Ring type selector switch: AR22S1R, S6R only) Selector switch (2-position only, except the overlap contact types) Illuminated selector switch (2-position only, except the overlap contact types)	Q600	0.55A	0.27A	0.1A
Pushbutton (Ring type selector switch: AR22S3R only) Selector switch (2-pos./overlap contact type, 3-, 4-, 5-pos. type) Illuminated selector switch (2-pos./overlap contact type, 3-pos. type)	R300	0.22A	0.11A	–

Note: Joy stick selector switches (Lever switches): 250V AC, 5A (Res. load) 125V DC, 0.2A 24V DC, 1A (Res. load)

● **EN standard/TÜV approved**

Description	Rated operational current			
	Rated thermal current	Rated operational voltage	AC15 (Ind. load)	DC13 (Ind. load)
			Rated operational current	Rated operational current
Illuminated pushbutton switch Pushbutton (Except the selector ring type) Emergency stop pushbutton switch Emergency stop illuminated pushbutton switch Selector switch (2-position) Illuminated selector switch (2-position)	10A	24V	6.0A	4.0A (AR22VG: 1.5A)
		120V	6.0A (AR22VG: 3A)	–
		125V	–	1.3A (AR22VG: 0.3A)
		240V	6.0A (AR22VG: 3A)	–
		250V	–	0.45A (AR22VG: 0.15A)
		480V	2.5A (AR22VG: –)	–
		600V	2.0A (AR22VG: –)	–
Selector switch (3, 4, 5-position) Illuminated selector switch (3-position) Pushbutton with selector ring	10A	24V	6.0A	2.0A
		120V	6.0A	–
		125V	–	0.65A
		240V	6.0A	–
		250V	–	0.23A
		480V	2.5A	–
		600V	2.0A	–
Joy stick selector switch (Lever switch)	5A	24V	–	0.7A
		120V	0.3A	–
		125V	–	0.15A
		240V	0.3A	–

Lamp rated voltage UL/CSA standards, TÜV approved

	LED lamp	Incandescent lamp	Neon lamp
Full-voltage (without transformer)	Max. 24V AC/DC	Max. 30V AC/DC	Max. 240V AC
With transformer	Max. 550V AC (Short-body type: Max. 220V AC)		–

Pushbuttons/Selectors/Pilot Lights/Buzzers AR22 and DR22 Ratings and specifications

■ Operating characteristic (1NO+1NC)

Description	Pushbutton Illuminated pushbutton	Emergency stop pushbutton		Selector *2		
		Emergency stop illuminated pushbutton		Illuminated selector		
		Push-lock type	Push-pull type	Maintained	Spring/manual return	Spring return
Ave. required operating force	9N (Push-lock type: 20N)	30N (AR22VG: 22N)*1	45N	0.15N•m	0.13N•m	0.1N•m
Operating travel	Approx. 6mm (Push-lock type: Approx. 9mm, operation angle: Approx. 45°)	Approx. 9mm (AR22VG: Approx. 10mm, operation angle: Approx. 45°)	Approx. 9mm	2-position: Approx. 90° 3-position: Approx. 45° 4-position: Approx. 40° 5-position: Approx. 30°	3-position: Approx. 45°	2-position: Approx. 60° 3-position: Approx. 45°
Required return force	– (Push-lock type: 0.6N•m)	0.6N•m (AR22VG: 0.2N•m)	30N (pull)	0.15N•m	0.13N•m	–

Notes: *1 AR22V2R, V4R, V7R, VAL types: 45N

*2 4-position, 5-position: 2NO+2NC

■ Lamp ratings

● Illuminated pushbuttons, illuminated selectors, pilot lights

Transformer	Lamp voltage	LED			Incandescent		
		Type	Rated voltage	Consumption	Type	Rated voltage	Consumption
Without transformer	5.5V AC/DC	–	–	–	AHX135	6.3V AC/DC	0.9W
	6V AC	APX510-6□	6V AC	Green, red, orange, amber, blue: 7mA AC Yellow: 50mA AC	–	–	–
	6V DC	APX510-D6□	6V DC	Green, red, orange, amber, blue: 11mA DC Yellow: 33mA DC	–	–	–
	12V AC/DC	APX510-12□	12V AC/DC	Green, red, orange, amber, blue: 14mA AC, 11mA DC Yellow: 28mA AC, 22mA DC	–	–	–
	15V AC/DC	APX510-15□	15V AC/DC	Green, red, orange, amber, blue: 13mA AC, 11mA DC Yellow: 26mA AC, 22mA DC	AHX279	18V AC/DC	0.8W
	20V AC/DC 24V AC/DC	– APX510-24□	– 24V AC/DC	– 12mA AC, 11mA DC	AHX144 AHX129	24V AC/DC 30V AC/DC	0.9W 0.8W
With transformer (Standard type: AR9T511)	110V AC	APX510-6□	6V AC	1.5VA	AHX135	6.3V AC/DC	2VA
	127V AC						2VA
	220V AC						2VA
	254V AC	APX510-6□	6V AC	2.5VA	AHX135	6.3V AC/DC	2.5VA
	380V AC 440V AC 480V AC 550V AC						2.5VA 2.5VA 2.5VA 2.5VA
With resistor unit (AR9T519-H)	110V DC	APX510-24□	24V AC/DC	1.2W	–	–	–

Notes: • Short body pilot lights: 110V AC, 127V AC, 220V AC only

• Replace the □ mark by the lamp luminous color code, see page 04/16

• Except AR22VGF type

● Emergency stop illuminated pushbuttons (AR22VGF type)

Transformer	Lamp	Voltage	Type	Rated voltage	Consumption
Without transformer	LED	24V AC/DC	AR9L002-ER	24V AC/DC	12mA AC 11mA DC
	Neon	110V AC	AR9N001-HA	110V AC	0.19VA
		120V AC	AR9N001-KA	120V AC	0.21VA
		220V AC	AR9N001-MA	220V AC	0.30VA
		240V AC	AR9N001-PA	240V AC	0.30VA

Notes: Lamp base: BA9S/13

Pushbuttons/Selectors/Pilot Lights/Buzzers

AR22 and DR22

Ratings and specifications

■ Lamp durability

Lamp	Durability (reference)	Judgement criterion
LED	Approx. 30000h	When brightness is less than 50% of initial value
Incandescent	Approx. 5000h (AC)	When the bulb burns out
Neon	Approx. 5000h	When a remarkable blackening appears in the glass bulb and the using becomes improper

Notes: • The operating voltage for incandescent lamps is set at 80 to 90% of the lamp's rated voltage.
 • The durability of LED lamp is a mean value in all colors.

Estimated durability for LED lamps

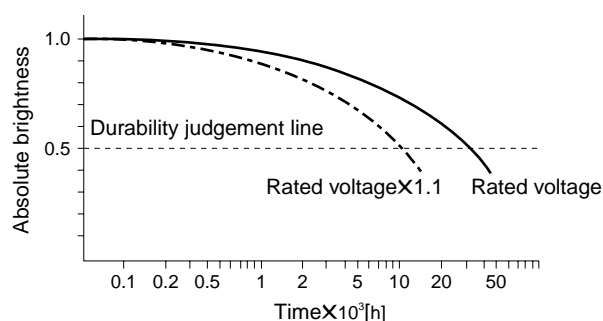

Notes: • Durability at $T_a=25^{\circ}\text{C}$
 • Durability is affected by temperature, humidity, and voltage fluctuation.

Incandescent lamp voltage characteristics

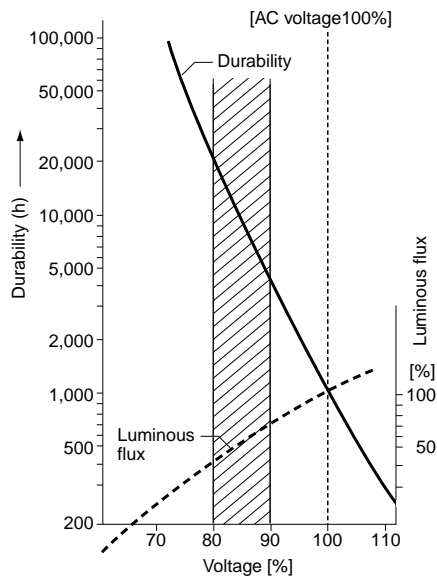







■ Combination of lens color and LED or neon lamp luminous color

Lens Color	Code	LED or neon lamp Luminous color	Type
Green	G	Green	APX510-■G
Red	R	Red	APX510-■R
White	W	Orange	APX510-■O
Yellow	Y	Yellow	APX510-■Y
Orange *	A	Amber	APX510-■A
Blue	S	Blue	APX510-■S
Red (AR22VGF)	R	Red	AR9L002-ER
		Orange (Neon lamp)	AR9N001-■A

Notes: * DR22F4M: LED lamp color is orange. (APX510-■O)
 • Replace the ■ mark by the lamp voltage code

■ Illuminated pushbutton switches

Operator	Transformer	Contact	LED lamp Momentary action Type	Alternate action Type	Incandescent lamp Momentary action Type	Alternate action Type
Flush round head  AF94-318	Without	1NO 1NC 1NO+1NC 2NO+2NC	AR22F0L-10■3□ AR22F0L-01■3□ AR22F0L-11■3□ AR22F0L-22■3□	AR22F5L-10■3□ AR22F5L-01■3□ AR22F5L-11■3□ —	AR22F0L-10■4□ AR22F0L-01■4□ AR22F0L-11■4□ AR22F0L-22■4□	AR22F5L-10■4□ AR22F5L-01■4□ AR22F5L-11■4□ —
	With	1NO 1NC 1NO+1NC	AR22F0L-10■3□ AR22F0L-01■3□ AR22F0L-11■3□	AR22F5L-10■3□ AR22F5L-01■3□ AR22F5L-11■3□	AR22F0L-10■4□ AR22F0L-01■4□ AR22F0L-11■4□	AR22F5L-10■4□ AR22F5L-01■4□ AR22F5L-11■4□
Extended round head  AF94-317	Without	1NO 1NC 1NO+1NC 2NO+2NC	AR22E0L-10■3□ AR22E0L-01■3□ AR22E0L-11■3□ AR22E0L-22■3□	AR22E5L-10■3□ AR22E5L-01■3□ AR22E5L-11■3□ —	AR22E0L-10■4□ AR22E0L-01■4□ AR22E0L-11■4□ AR22E0L-22■4□	AR22E5L-10■4□ AR22E5L-01■4□ AR22E5L-11■4□ —
	With	1NO 1NC 1NO+1NC	AR22E0L-10■3□ AR22E0L-01■3□ AR22E0L-11■3□	AR22E5L-10■3□ AR22E5L-01■3□ AR22E5L-11■3□	AR22E0L-10■4□ AR22E0L-01■4□ AR22E0L-11■4□	AR22E5L-10■4□ AR22E5L-01■4□ AR22E5L-11■4□
Mushroom head (40mm dia.)  AF94-367	Without	1NO 1NC 1NO+1NC 2NO+2NC	AR22M0L-10■3□ AR22M0L-01■3□ AR22M0L-11■3□ AR22M0L-22■3□	AR22M5L-10■3□ AR22M5L-01■3□ AR22M5L-11■3□ —	AR22M0L-10■4□ AR22M0L-01■4□ AR22M0L-11■4□ AR22M0L-22■4□	AR22M5L-10■4□ AR22M5L-01■4□ AR22M5L-11■4□ —
	With	1NO 1NC 1NO+1NC	AR22M0L-10■3□ AR22M0L-01■3□ AR22M0L-11■3□	AR22M5L-10■3□ AR22M5L-01■3□ AR22M5L-11■3□	AR22M0L-10■4□ AR22M0L-01■4□ AR22M0L-11■4□	AR22M5L-10■4□ AR22M5L-01■4□ AR22M5L-11■4□
Mushroom head (29mm dia.)  AF94-369	Without	1NO 1NC 1NO+1NC 2NO+2NC	AR22M4L-10■3□ AR22M4L-01■3□ AR22M4L-11■3□ AR22M4L-22■3□	AR22M9L-10■3□ AR22M9L-01■3□ AR22M9L-11■3□ —	AR22M4L-10■4□ AR22M4L-01■4□ AR22M4L-11■4□ AR22M4L-22■4□	AR22M9L-10■4□ AR22M9L-01■4□ AR22M9L-11■4□ —
	With	1NO 1NC 1NO+1NC	AR22M4L-10■3□ AR22M4L-01■3□ AR22M4L-11■3□	AR22M9L-10■3□ AR22M9L-01■3□ AR22M9L-11■3□	AR22M4L-10■4□ AR22M4L-01■4□ AR22M4L-11■4□	AR22M9L-10■4□ AR22M9L-01■4□ AR22M9L-11■4□
Extended with transparent full guard (24mm dia.)  AF94-294	Without	1NO 1NC 1NO+1NC 2NO+2NC	AR22G4L-10■3□ AR22G4L-01■3□ AR22G4L-11■3□ AR22G4L-22■3□	AR22G9L-10■3□ AR22G9L-01■3□ AR22G9L-11■3□ —	AR22G4L-10■4□ AR22G4L-01■4□ AR22G4L-11■4□ AR22G4L-22■4□	AR22G9L-10■4□ AR22G9L-01■4□ AR22G9L-11■4□ —
	With	1NO 1NC 1NO+1NC	AR22G4L-10■3□ AR22G4L-01■3□ AR22G4L-11■3□	AR22G9L-10■3□ AR22G9L-01■3□ AR22G9L-11■3□	AR22G4L-10■4□ AR22G4L-01■4□ AR22G4L-11■4□	AR22G9L-10■4□ AR22G9L-01■4□ AR22G9L-11■4□
Extended with full guard (24mm dia. with openings)  AF99-319	Without	1NO 1NC 1NO+1NC 2NO+2NC	AR22G2L-10■3□ AR22G2L-01■3□ AR22G2L-11■3□ AR22G2L-22■3□	AR22G7L-10■3□ AR22G7L-01■3□ AR22G7L-11■3□ —	AR22G2L-10■4□ AR22G2L-01■4□ AR22G2L-11■4□ AR22G2L-22■4□	AR22G7L-10■4□ AR22G7L-01■4□ AR22G7L-11■4□ —
	With	1NO 1NC 1NO+1NC	AR22G2L-10■3□ AR22G2L-01■3□ AR22G2L-11■3□	AR22G7L-10■3□ AR22G7L-01■3□ AR22G7L-11■3□	AR22G2L-10■4□ AR22G2L-01■4□ AR22G2L-11■4□	AR22G7L-10■4□ AR22G7L-01■4□ AR22G7L-11■4□

Note: ■ □ See page 04/19

Illuminated Pushbuttons

AR22

Operator	Transformer	Contact	LED lamp Momentary action Type	Alternate action Type	Incandescent lamp Momentary action Type	Alternate action Type
Extended with full guard (24mm dia.)  <small>KK02-127A</small>	Without	1NO 1NC 1NO+1NC 2NO+2NC	AR22G1L-10■3□ AR22G1L-01■3□ AR22G1L-11■3□ AR22G1L-22■3□	AR22G6L-10■3□ AR22G6L-01■3□ AR22G6L-11■3□ —	AR22G1L-10■4□ AR22G1L-01■4□ AR22G1L-11■4□ AR22G1L-22■4□	AR22G6L-10■4□ AR22G6L-01■4□ AR22G6L-11■4□ —
	With	1NO 1NC 1NO+1NC	AR22G1L-10■3□ AR22G1L-01■3□ AR22G1L-11■3□	AR22G6L-10■3□ AR22G6L-01■3□ AR22G6L-11■3□	AR22G1L-10■4□ AR22G1L-01■4□ AR22G1L-11■4□	AR22G6L-10■4□ AR22G6L-01■4□ AR22G6L-11■4□
Push-lock, turn-reset (40mm dia. with white arrow)  <small>KKD06-335</small>	Without	1NO 1NC 1NO+1NC 3NC	— — — —	AR22V5L-10■3□ AR22V5L-01■3□ AR22V5L-11■3□ AR22V5L-03■3□	— — — —	AR22V5L-10■4□ AR22V5L-01■4□ AR22V5L-11■4□ AR22V5L-03■4□
	With	1NO 1NC 1NO+1NC	— — —	AR22V5L-10■3□ AR22V5L-01■3□ AR22V5L-11■3□	— — —	AR22V5L-10■4□ AR22V5L-01■4□ AR22V5L-11■4□
Flush square head  <small>AF97-68</small>	Without	1NO 1NC 1NO+1NC 2NO+2NC	AR22F0M-10■3□ AR22F0M-01■3□ AR22F0M-11■3□ AR22F0M-22■3□	AR22F5M-10■3□ AR22F5M-01■3□ AR22F5M-11■3□ —	AR22F0M-10■4□ AR22F0M-01■4□ AR22F0M-11■4□ AR22F0M-22■4□	AR22F5M-10■4□ AR22F5M-01■4□ AR22F5M-11■4□ —
	With	1NO 1NC 1NO+1NC	AR22F0M-10■3□ AR22F0M-01■3□ AR22F0M-11■3□	AR22F5M-10■3□ AR22F5M-01■3□ AR22F5M-11■3□	AR22F0M-10■4□ AR22F0M-01■4□ AR22F0M-11■4□	AR22F5M-10■4□ AR22F5M-01■4□ AR22F5M-11■4□
Extended square head  <small>AF94-357</small>	Without	1NO 1NC 1NO+1NC 2NO+2NC	AR22E0M-10■3□ AR22E0M-01■3□ AR22E0M-11■3□ AR22E0M-22■3□	AR22E5M-10■3□ AR22E5M-01■3□ AR22E5M-11■3□ —	AR22E0M-10■4□ AR22E0M-01■4□ AR22E0M-11■4□ AR22E0M-22■4□	AR22E5M-10■4□ AR22E5M-01■4□ AR22E5M-11■4□ —
	With	1NO 1NC 1NO+1NC	AR22E0M-10■3□ AR22E0M-01■3□ AR22E0M-11■3□	AR22E5M-10■3□ AR22E5M-01■3□ AR22E5M-11■3□	AR22E0M-10■4□ AR22E0M-01■4□ AR22E0M-11■4□	AR22E5M-10■4□ AR22E5M-01■4□ AR22E5M-11■4□
Flush round head with square bezel  <small>AF94-315</small>	Without	1NO 1NC 1NO+1NC 2NO+2NC	AR22F0P-10■3□ AR22F0P-01■3□ AR22F0P-11■3□ AR22F0P-22■3□	AR22F5P-10■3□ AR22F5P-01■3□ AR22F5P-11■3□ —	AR22F0P-10■4□ AR22F0P-01■4□ AR22F0P-11■4□ AR22F0P-22■4□	AR22F5P-10■4□ AR22F5P-01■4□ AR22F5P-11■4□ —
	With	1NO 1NC 1NO+1NC	AR22F0P-10■3□ AR22F0P-01■3□ AR22F0P-11■3□	AR22F5P-10■3□ AR22F5P-01■3□ AR22F5P-11■3□	AR22F0P-10■4□ AR22F0P-01■4□ AR22F0P-11■4□	AR22F5P-10■4□ AR22F5P-01■4□ AR22F5P-11■4□
Extended round head with square bezel  <small>AF94-314</small>	Without	1NO 1NC 1NO+1NC 2NO+2NC	AR22E0P-10■3□ AR22E0P-01■3□ AR22E0P-11■3□ AR22E0P-22■3□	AR22E5P-10■3□ AR22E5P-01■3□ AR22E5P-11■3□ —	AR22E0P-10■4□ AR22E0P-01■4□ AR22E0P-11■4□ AR22E0P-22■4□	AR22E5P-10■4□ AR22E5P-01■4□ AR22E5P-11■4□ —
	With	1NO 1NC 1NO+1NC	AR22E0P-10■3□ AR22E0P-01■3□ AR22E0P-11■3□	AR22E5P-10■3□ AR22E5P-01■3□ AR22E5P-11■3□	AR22E0P-10■4□ AR22E0P-01■4□ AR22E0P-11■4□	AR22E5P-10■4□ AR22E5P-01■4□ AR22E5P-11■4□

Note: ■ □ See page 04/19

Operator	Trans- former	Contact	LED lamp		Incandescent lamp	
			Momentary action Type	Alternate action Type	Momentary action Type	Alternate action Type
Mushroom head with square bezel (29mm dia.)  AF94-440	Without	1NO	AR22M4P-10■3□	—	AR22M4P-10■4□	—
		1NC	AR22M4P-01■3□	—	AR22M4P-01■4□	—
		1NO+1NC	AR22M4P-11■3□	—	AR22M4P-11■4□	—
		2NO+2NC	AR22M4P-22■3□	—	AR22M4P-22■4□	—
	With	1NO	AR22M4P-10■3□	—	AR22M4P-10■4□	—
		1NO+1NC	AR22M4P-11■3□	—	AR22M4P-11■4□	—

• **Lens color**

Replace the □ mark by the lens color code

Color	Green	Red	White	Blue	Yellow	Orange
Code	G	R	W	S	Y	A

Note: AR22V5L type: Red, yellow only

• **Contact arrangements**

Contact arrangements other than above are available

Contact arrangement	1NO	1NC	1NO+1NC	2NO	2NC	3NO
Code	10	01	11	20	02	30

Contact arrangement	3NC	2NO+2NC	4NO	4NC	5NO	5NC
Code	03	22	40	04	50	05

Available numbers of contact blocks

Operation	Without transformer	With transformer
Momentary action	5-contact block	3-contact block
Alternate action Push-lock, turn-reset	3-contact block	2-contact block

• **Voltage**

Replace the ■ mark by the lamp voltage code

Transformer		Code	
		LED	Incandescent
Without transformer	6V DC	6	—
	6V AC	A	—
	5.5V AC/DC	—	5
	12V AC/DC	B	—
	15V AC/DC	C	C
	20V AC/DC 24V AC/DC	— E	D E
With transformer	100-110V AC	H	H
	115-127V AC	L	L
	200-220V AC	M	M
	230-254V AC	Q	Q
	350-380V AC	S	S
	400-440V AC	T	T
	480V AC	V	V
	500-550V AC	W	W

Pushbuttons

AR22

■ Pushbutton switches

Operator	Contact	Momentary action Type	Alternate action Type
Flush round head  <small>AF94-320</small>	1NO 1NC 1NO+1NC 2NO 2NC 2NO+2NC	AR22F0R-10 □ AR22F5R-10 □ AR22F0R-01 □ AR22F5R-01 □ AR22F0R-11 □ AR22F5R-11 □ AR22F0R-20 □ AR22F5R-20 □ AR22F0R-02 □ AR22F5R-02 □ AR22F0R-22 □ AR22F5R-22 □	
Extended round head  <small>AF94-319</small>	1NO 1NC 1NO+1NC 2NO 2NC 2NO+2NC	AR22E0R-10 □ AR22E5R-10 □ AR22E0R-01 □ AR22E5R-01 □ AR22E0R-11 □ AR22E5R-11 □ AR22E0R-20 □ AR22E5R-20 □ AR22E0R-02 □ AR22E5R-02 □ AR22E0R-22 □ AR22E5R-22 □	
Flush round head symbol mark type  <small>AF98-193</small>	1NO 1NC 1NO+1NC 2NO 2NC 2NO+2NC	AR22FAR-10C ■ AR22FBR-10C ■ AR22FAR-01C ■ AR22FBR-01C ■ AR22FAR-11C ■ AR22FBR-11C ■ AR22FAR-20C ■ AR22FBR-20C ■ AR22FAR-02C ■ AR22FBR-02C ■ AR22FAR-22C ■ AR22FBR-22C ■	
Extended round head symbol mark type  <small>AF98-192</small>	1NO 1NC 1NO+1NC 2NO 2NC 2NO+2NC	AR22EAR-10C ■ AR22EBR-10C ■ AR22EAR-01C ■ AR22EBR-01C ■ AR22EAR-11C ■ AR22EBR-11C ■ AR22EAR-20C ■ AR22EBR-20C ■ AR22EAR-02C ■ AR22EBR-02C ■ AR22EAR-22C ■ AR22EBR-22C ■	
Mushroom head (40mm dia.)  <small>AF94-293</small>	1NO 1NC 1NO+1NC 2NO 2NC 2NO+2NC	AR22M0R-10 □ AR22M5R-10 □ AR22M0R-01 □ AR22M5R-01 □ AR22M0R-11 □ AR22M5R-11 □ AR22M0R-20 □ AR22M5R-20 □ AR22M0R-02 □ AR22M5R-02 □ AR22M0R-22 □ AR22M5R-22 □	
Mushroom head (29mm dia.)  <small>AF94-321</small>	1NO 1NC 1NO+1NC 2NO 2NC 2NO+2NC	AR22M4R-10 □ AR22M9R-10 □ AR22M4R-01 □ AR22M9R-01 □ AR22M4R-11 □ AR22M9R-11 □ AR22M4R-20 □ AR22M9R-20 □ AR22M4R-02 □ AR22M9R-02 □ AR22M4R-22 □ AR22M9R-22 □	
Extended with full guard (24mm dia.)  <small>AF94-292</small>	1NO 1NC 1NO+1NC 2NO 2NC 2NO+2NC	AR22G3R-10 □ AR22G8R-10 □ AR22G3R-01 □ AR22G8R-01 □ AR22G3R-11 □ AR22G8R-11 □ AR22G3R-20 □ AR22G8R-20 □ AR22G3R-02 □ AR22G8R-02 □ AR22G3R-22 □ AR22G8R-22 □	

Note: ■ □ See page 04/21

Operator	Contact	Momentary action Type	Alternate action Type
Flush with full guard (24mm dia.)  <small>AF02-68</small>	1NO 1NC 1NO+1NC 2NO 2NC 2NO+2NC	AR22G2R-10 □ AR22G7R-10 □ AR22G2R-01 □ AR22G7R-01 □ AR22G2R-11 □ AR22G7R-11 □ AR22G2R-20 □ AR22G7R-20 □ AR22G2R-02 □ AR22G7R-02 □ AR22G2R-22 □ AR22G7R-22 □	
Mushroom head with full guard (40mm dia.)  <small>AF94-372</small>	1NO 1NC 1NO+1NC 2NO 2NC 2NO+2NC	AR22M3R-10 □ AR22M8R-10 □ AR22M3R-01 □ AR22M8R-01 □ AR22M3R-11 □ AR22M8R-11 □ AR22M3R-20 □ AR22M8R-20 □ AR22M3R-02 □ AR22M8R-02 □ AR22M3R-22 □ AR22M8R-22 □	
Extended with half guard  <small>AF96-236</small>	1NO 1NC 1NO+1NC 2NO 2NC 2NO+2NC	AR22G0R-10 □ AR22G5R-10 □ AR22G0R-01 □ AR22G5R-01 □ AR22G0R-11 □ AR22G5R-11 □ AR22G0R-20 □ AR22G5R-20 □ AR22G0R-02 □ AR22G5R-02 □ AR22G0R-22 □ AR22G5R-22 □	
Push-lock, turn-reset (40mm dia. with white arrow)  <small>KKD08-042</small>	1NO 1NC 1NO+1NC 2NO 2NC 2NO+2NC	— — — — — —	AR22V5R-10 □ AR22V5R-01 □ AR22V5R-11 □ AR22V5R-20 □ AR22V5R-02 □ AR22V5R-22 □
Flush square head  <small>AF94-316</small>	1NO 1NC 1NO+1NC 2NO 2NC 2NO+2NC	AR22F0S-10 □ AR22F5S-10 □ AR22F0S-01 □ AR22F5S-01 □ AR22F0S-11 □ AR22F5S-11 □ AR22F0S-20 □ AR22F5S-20 □ AR22F0S-02 □ AR22F5S-02 □ AR22F0S-22 □ AR22F5S-22 □	
Extended square head  <small>AF94-296</small>	1NO 1NC 1NO+1NC 2NO 2NC 2NO+2NC	AR22E0S-10 □ AR22E5S-10 □ AR22E0S-01 □ AR22E5S-01 □ AR22E0S-11 □ AR22E5S-11 □ AR22E0S-20 □ AR22E5S-20 □ AR22E0S-02 □ AR22E5S-02 □ AR22E0S-22 □ AR22E5S-22 □	
Flush round head with square bezel  <small>AF94-295</small>	1NO 1NC 1NO+1NC 2NO 2NC 2NO+2NC	AR22F0Y-10 □ AR22F5Y-10 □ AR22F0Y-01 □ AR22F5Y-01 □ AR22F0Y-11 □ AR22F5Y-11 □ AR22F0Y-20 □ AR22F5Y-20 □ AR22F0Y-02 □ AR22F5Y-02 □ AR22F0Y-22 □ AR22F5Y-22 □	

Operator	Contact	Momentary action Type	Alternate action Type
Extended round head with square bezel  AF94-297	1NO	AR22E0Y-10□	AR22E5Y-10□
	1NC	AR22E0Y-01□	AR22E5Y-01□
	1NO+1NC	AR22E0Y-11□	AR22E5Y-11□
	2NO	AR22E0Y-20□	AR22E5Y-20□
	2NC	AR22E0Y-02□	AR22E5Y-02□
	2NO+2NC	AR22E0Y-22□	AR22E5Y-22□

Operator	Contact	Momentary action Type	Alternate action Type
Mushroom head with square bezel (29mm dia.)  AF94-298	1NO	AR22M4Y-10□	—
	1NC	AR22M4Y-01□	—
	1NO+1NC	AR22M4Y-11□	—
	2NO	AR22M4Y-20□	—
	2NC	AR22M4Y-02□	—
	2NO+2NC	AR22M4Y-22□	—

• **Button color**

Replace the □ mark by the button color code

Color	Green	Red	White	Blue	Yellow	Orange	Black
Code	G	R	W	S	Y	A	B

Note: AR22V5R type: Red, yellow, black only

• **Available numbers of contact blocks**

Momentary action	Alternate action Push-lock, turn-reset
6-contact block	4-contact block

04

• **Contact arrangements**

Contact arrangements other than above are available

Contact arrangement	1NO	1NC	1NO+1NC	2NO	2NC	3NO	3NC
Code	10	01	11	20	02	30	03



Contact arrangement	2NO+2NC	4NO	4NC	5NO	5NC	3NO+3NC
Code	22	40	04	50	05	33

• **Symbol mark** (For AR22FAR, FBR, EAR, EBR)

Replace the ■ mark by the symbol mark code

Symbol mark	○	I	Ⓢ	○	I	Ⓢ
Color of button	White Black	White Black	White Black	Clear		
Color of mark	Red	Green	Green	Black		
Code	01 02	03 04	11 12	02B 04B 12B		

Pushbuttons AR22

Operator	Contact (The following contact is only available.)	Button color	Type	Contact operation					
				Contact block		Left 		Right 	
				Mounting position	Type	Free	Depressed	Free	Depressed
Pushbutton with selector ring (2-position)  AF94-355	2NO+2NC	Green Red Black White Yellow Orange Blue	AR22S1R-22G AR22S1R-22R AR22S1R-22B AR22S1R-22W AR22S1R-22Y AR22S1R-22A AR22S1R-22S	(1)	NC	—	—	●	—
				(2)	NC	—	—	●	—
				(3)	NO	—	●	—	●
				(4)	NO	—	●	—	●
	2NO	Green Red Black White Yellow Orange Blue	AR22S2R-20G AR22S2R-20R AR22S2R-20B AR22S2R-20W AR22S2R-20Y AR22S2R-20A AR22S2R-20S	(1)	NO	—	●	—	—
				(2)	NO	—	—	—	●
				(3)					
				(4)					
	2NO+2NC	Green Red Black White Yellow Orange Blue	AR22S2R-22G AR22S2R-22R AR22S2R-22B AR22S2R-22W AR22S2R-22Y AR22S2R-22A AR22S2R-22S	(1)	NC	●	—	■	
				(2)	NC	■		●	—
				(3)	NO	—	●	—	—
				(4)	NO	—	—	—	●
	2NO+2NC	Green Red Black White Yellow Orange Blue	AR22S3R-22G AR22S3R-22R AR22S3R-22B AR22S3R-22W AR22S3R-22Y AR22S3R-22A AR22S3R-22S	(1)	NC	—	—	■	
				(2)	NC	■		—	—
				(3)	NO	—	●	—	—
				(4)	NO	—	—	—	●
	2NO+2NC	Green Red Black White Yellow Orange Blue	AR22S6R-22G AR22S6R-22R AR22S6R-22B AR22S6R-22W AR22S6R-22Y AR22S6R-22A AR22S6R-22S	(1)	NC	●	—	—	Locked
				(2)	NC	●	—	—	
				(3)	NO	—	●	●	
				(4)	NO	—	●	●	

Note: (1) to (4): Contact block mounting position



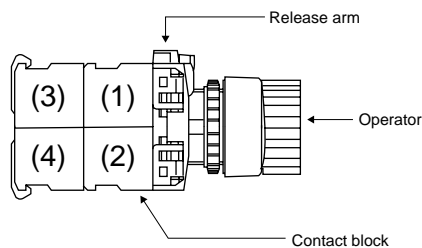

● Contact closed
— Contact open

● Position of contact block





■ Emergency stop pushbutton switches

⊙ (Direct opening action), conform to EN418

Operator	Contact	Type
Push-lock, turn-reset (Soft-touch 40mm dia. With white arrow)  <small>KKD08-042</small>	1NC 1NO+1NC 2NC 3NC 2NO+2NC 4NC	AR22V0R-01R AR22V0R-11R AR22V0R-02R AR22V0R-03R AR22V0R-22R AR22V0R-04R
Push-lock, turn-reset (40mm dia.)  <small>KKD05-020b</small>	1NC 1NO+1NC 2NC 3NC 2NO+2NC 4NC	AR22V2R-01R AR22V2R-11R AR22V2R-02R AR22V2R-03R AR22V2R-22R AR22V2R-04R
Push-lock, turn-reset (Soft-touch 29mm dia. with white arrow)  <small>KKD06-346</small>	1NC 1NO+1NC 2NC 3NC 2NO+2NC 4NC	AR22VSR-01R AR22VSR-11R AR22VSR-02R AR22VSR-03R AR22VSR-22R AR22VSR-04R
Push-lock, turn-reset (29mm dia.)  <small>KKD06-339</small>	1NC 1NO+1NC 2NC 3NC 2NO+2NC 4NC	AR22V4R-01R AR22V4R-11R AR22V4R-02R AR22V4R-03R AR22V4R-22R AR22V4R-04R







Notes: • Button color : Red only
 • Contact arrangements indicated in the table can be supplied.

Operator	Contact	Type
Key release push-lock, turn-reset (40mm dia.)  <small>KKD09-020</small>	1NC 1NO+1NC 2NC 3NC 2NO+2NC 4NC	AR22V7R-01R AR22V7R-11R AR22V7R-02R AR22V7R-03R AR22V7R-22R AR22V7R-04R
Push-lock, pull-reset (35mm dia.)  <small>KKD06-334</small>	1NC 1NO+1NC 2NC	AR22Q2R-01R AR22Q2R-11R AR22Q2R-02R
Unibody push-lock, turn-reset (Soft-touch 40mm dia. with white arrow)  <small>KKD05-023b</small>	1NC 1NO+1NC 2NC	AR22VGE-01R AR22VGE-11R AR22VGE-02R

Emergency Stop Illuminated Pushbuttons AR22

Emergency stop illuminated pushbutton switches

☺ (Direct opening action), conform to EN418

Operator	Transformer	Contact	LED lamp Type	Incandescent lamp Type	Neon lamp Type
Push-lock, turn-reset (Soft-touch 40mm dia. with white arrow)  KKD06-335	Without	1NC 1NO+1NC 2NC 3NC	AR22V0L-01■3R AR22V0L-11■3R AR22V0L-02■3R AR22V0L-03■3R	AR22V0L-01■4R AR22V0L-11■4R AR22V0L-02■4R AR22V0L-03■4R	— — — —
	With	1NC 1NO+1NC 2NC	AR22V0L-01■3R AR22V0L-11■3R AR22V0L-02■3R	AR22V0L-01■4R AR22V0L-11■4R AR22V0L-02■4R	— — —
Push-lock, turn-reset (40mm dia.)  KKD06-337	Without	1NC 1NO+1NC 2NC 3NC	AR22V2L-01■3R AR22V2L-11■3R AR22V2L-02■3R AR22V2L-03■3R	AR22V2L-01■4R AR22V2L-11■4R AR22V2L-02■4R AR22V2L-03■4R	— — — —
	With	1NC 1NO+1NC 2NC	AR22V2L-01■3R AR22V2L-11■3R AR22V2L-02■3R	AR22V2L-01■4R AR22V2L-11■4R AR22V2L-02■4R	— — —
Push-lock, turn-reset (Soft-touch 40mm dia. transparent in all colors with white arrow)  KKD06-342	Without	1NC 1NO+1NC 2NC 3NC	AR22VDL-01■3R AR22VDL-11■3R AR22VDL-02■3R AR22VDL-03■3R	AR22VDL-01■4R AR22VDL-11■4R AR22VDL-02■4R AR22VDL-03■4R	— — — —
	With	1NC 1NO+1NC 2NC	AR22VDL-01■3R AR22VDL-11■3R AR22VDL-02■3R	AR22VDL-01■4R AR22VDL-11■4R AR22VDL-02■4R	— — —
Push-lock, turn-reset (40mm dia. transparent in all colors)  KKD06-340	Without	1NC 1NO+1NC 2NC 3NC	AR22VAL-01■3R AR22VAL-11■3R AR22VAL-02■3R AR22VAL-03■3R	AR22VAL-01■4R AR22VAL-11■4R AR22VAL-02■4R AR22VAL-03■4R	— — — —
	With	1NC 1NO+1NC 2NC	AR22VAL-01■3R AR22VAL-11■3R AR22VAL-02■3R	AR22VAL-01■4R AR22VAL-11■4R AR22VAL-02■4R	— — —
Push-lock, turn-reset (Soft-touch 29mm dia. with white arrow)  KKD06-344	Without	1NC 1NO+1NC 2NC 3NC	AR22VSL-01■3R AR22VSL-11■3R AR22VSL-02■3R AR22VSL-03■3R	AR22VSL-01■4R AR22VSL-11■4R AR22VSL-02■4R AR22VSL-03■4R	— — — —
	With	1NC 1NO+1NC 2NC	AR22VSL-01■3R AR22VSL-11■3R AR22VSL-02■3R	AR22VSL-01■4R AR22VSL-11■4R AR22VSL-02■4R	— — —
Unibody push-lock, turn-reset (Soft-touch 40mm dia. with white arrow)  KKD05-150	Without	1NC 1NO+1NC 2NC	AR22VGF-01E3R AR22VGF-11E3R AR22VGF-02E3R	— — —	AR22VGF-01■1R AR22VGF-11■1R AR22VGF-02■1R

Notes: • Button color: Red only • AR22VGF type: Lamp circuit contacts are provided, see page 04/43. • Contact arrangements indicated in the table can be supplied.

Voltage











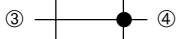

Replace the ■ mark by the lamp voltage code

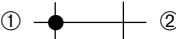
Transformer	Code	Code		
		LED	Incandescent	Neon
Without	6V DC	6	—	—
	6V AC	A	—	—
	5V AC/DC	—	5	—
	12V AC/DC	B	—	—
	15V AC/DC	C	—	—
	20V AC/DC	—	D	—
	24V AC/DC	E	—	—
	110V AC	—	—	H
	120V AC	—	—	K
	220V AC	—	—	M
	240V AC	—	—	P

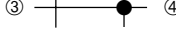
Notes: AR22VGF: LED 24V AC/DC and neon only

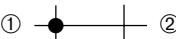
Transformer	Code	Code	
		LED	Incandescent
With	100-110V AC	H	H
	115-127V AC	L	L
	200-220V AC	M	M
	230-254V AC	Q	Q
	350-380V AC	S	S
	400-440V AC	T	T
	480V AC	V	V
	500-550V AC	W	W

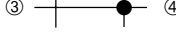
■ Selector switches 2-position

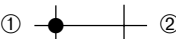
Operator	Operation	Knob color or key removable position	Contact	Type		Contact operation (Example)		
				Switch with round bezel	Switch with square bezel	Contact arrangement	Operator position	
							Left	Right
 AF94-310	Maintained	Color code: B: Black (Standard) Color other than above are available (G: Green) (R: Red)	1NO 1NC 1NO+1NC 2NO 2NC 2NO+2NC	AR22PR-210B AR22PR-201B AR22PR-211B AR22PR-220B AR22PR-202B AR22PR-222B	AR22PY-210B AR22PY-201B AR22PY-211B AR22PY-220B AR22PY-202B AR22PY-222B	1NO (1)	Upper contact 	
	each 90°						1NC (1)	Upper contact 
	Spring return  60°							1NO+1NC (1)
 AF94-324	Maintained		1NO 1NC 1NO+1NC 2NO 2NC 2NO+2NC	AR22WR-210B AR22WR-201B AR22WR-211B AR22WR-220B AR22WR-202B AR22WR-222B	AR22WY-210B AR22WY-201B AR22WY-211B AR22WY-220B AR22WY-202B AR22WY-222B	1NO (1)	Upper contact 	
	each 90°						(2)	Lower contact 
	Spring return  60°							2NO+2NC (1)
 AF94-308	Maintained		1NO 1NC 1NO+1NC 2NO 2NC 2NO+2NC	AR22RR-210B AR22RR-201B AR22RR-211B AR22RR-220B AR22RR-202B AR22RR-222B	AR22RY-210B AR22RY-201B AR22RY-211B AR22RY-220B AR22RY-202B AR22RY-222B	1NO (1)	Upper contact 	
	each 90°						(2)	Lower contact 
	Spring return  60°							(4) 
 KKD09-018	Maintained	■: Key removable position (): Key type <i>See page 04/27</i>	1NO 1NC 1NO+1NC 2NO 2NC 2NO+2NC	AR22J□R-2■10() AR22J□R-2■01() AR22J□R-2■11() AR22J□R-2■20() AR22J□R-2■02() AR22J□R-2■22()	AR22JY-2■10() AR22JY-2■01() AR22JY-2■11() AR22JY-2■20() AR22JY-2■02() AR22JY-2■22()	1NO (1)	Upper contact 	
	each 90°						(2)	Lower contact 
	Spring return  60°							(4) 

Notes: • (1) to (4): Contact block mounting position
 • ① - ②, ③ - ④: Contact block terminal No.
 • Contact arrangements: See page 04/27

● Contact closed



● Operator

Replace the □ mark by the cylinder key type code
 Standard type: Blank
 Long durability type: A

Selector Switches

AR22

3-position

Operator	Operation	Knob color	Contact	Type	Switch with round bezel	Switch with square bezel	Contact operation (Example)						
							Contact arrangement	Operation position			Operation position		
								L	C	R	L	C	R
 <p>AF94-310</p>	Maintained each 45°	Color code: B: Black (Standard) Color other than above are available (G: Green) (R: Red)	1NO+1NC 2NO 2NC 2NO+2NC	AR22PR-311B AR22PR-320B AR22PR-302B AR22PR-322B	AR22PY-311B AR22PY-320B AR22PY-302B AR22PY-322B	1NO+1NC (1) (2)	Upper contact ③ ④	Lower contact ① ②					
	Spring/manual return ⤴ each 45°		1NO+1NC 2NO 2NC 2NO+2NC	AR22PR-611B AR22PR-620B AR22PR-602B AR22PR-622B	AR22PY-611B AR22PY-620B AR22PY-602B AR22PY-622B	1NO+1NC (1) (2)	Upper contact ③ ④	Lower contact ① ②					
	Spring/manual return ⤵ each 45°		1NO+1NC 2NO 2NC 2NO+2NC	AR22PR-711B AR22PR-720B AR22PR-702B AR22PR-722B	AR22PY-711B AR22PY-720B AR22PY-702B AR22PY-722B	1NO+1NC (1) (2)	Upper contact ③ ④	Lower contact ① ②					
	Spring return ⤴⤵ each 45°		2NO+2NC	AR22PR-122B AR22PY-122B	2NO+2NC (1) (2)	Upper contact ① ②	Lower contact ① ②	(3) (4) ③ ④ ③ ④	(3) (4) ③ ④ ③ ④				
 <p>AF94-324</p>	Maintained each 45°		1NO+1NC 2NO 2NC 2NO+2NC	AR22WR-311B AR22WR-320B AR22WR-302B AR22WR-322B	AR22WY-311B AR22WY-320B AR22WY-302B AR22WY-322B	1NO+1NC (1) (2)	Upper contact ③ ④	Lower contact ① ②					
	Spring/manual return ⤴ each 45°		1NO+1NC 2NO 2NC 2NO+2NC	AR22WR-611B AR22WR-620B AR22WR-602B AR22WR-622B	AR22WY-611B AR22WY-620B AR22WY-602B AR22WY-622B	1NO+1NC (1) (2)	Upper contact ③ ④	Lower contact ① ②					
	Spring/manual return ⤵ each 45°		1NO+1NC 2NO 2NC 2NO+2NC	AR22WR-711B AR22WR-720B AR22WR-702B AR22WR-722B	AR22WY-711B AR22WY-720B AR22WY-702B AR22WY-722B	1NO+1NC (1) (2)	Upper contact ③ ④	Lower contact ① ②					
	Spring return ⤴⤵ each 45°		2NO+2NC	AR22WR-122B AR22WY-122B	2NO+2NC (1) (2)	Upper contact ① ②	Lower contact ① ②	(3) (4) ③ ④ ③ ④	(3) (4) ③ ④ ③ ④				
 <p>AF94-308</p>	Maintained each 45°		1NO+1NC 2NO 2NC 2NO+2NC	AR22RR-311B AR22RR-320B AR22RR-302B AR22RR-322B	AR22RY-311B AR22RY-320B AR22RY-302B AR22RY-322B	1NO+1NC (1) (2)	Upper contact ③ ④	Lower contact ① ②					
	Spring/manual return ⤴ each 45°		1NO+1NC 2NO 2NC 2NO+2NC	AR22RR-611B AR22RR-620B AR22RR-602B AR22RR-622B	AR22RY-611B AR22RY-620B AR22RY-602B AR22RY-622B	1NO+1NC (1) (2)	Upper contact ③ ④	Lower contact ① ②					
	Spring/manual return ⤵ each 45°		1NO+1NC 2NO 2NC 2NO+2NC	AR22RR-711B AR22RR-720B AR22RR-702B AR22RR-722B	AR22RY-711B AR22RY-720B AR22RY-702B AR22RY-722B	1NO+1NC (1) (2)	Upper contact ③ ④	Lower contact ① ②					
	Spring return ⤴⤵ each 45°		2NO+2NC	AR22RR-122B AR22RY-122B	2NO+2NC (1) (2)	Upper contact ① ②	Lower contact ① ②	(3) (4) ③ ④ ③ ④	(3) (4) ③ ④ ③ ④				

Operator	Operation	Key removable position	Contact	Type Switch with round bezel	Switch with square bezel	Contact operation (Example)	
						Contact arrangement	Operator position
						L C R ⊖ ⊕ ⊗	L C R ⊖ ⊕ ⊗
 KKD09-018	Maintained each 45°	■: Key removable position (): Key type	1NO+1NC 2NO 2NC 2NO+2NC	AR22J□R-3■11() AR22JY-3■11() AR22J□R-3■20() AR22JY-3■20() AR22J□R-3■02() AR22JY-3■02() AR22J□R-3■22() AR22JY-3■22()	1NO+1NC (1) (2)	Upper contact ③ ⊖ ⊕ ⊗ ④	Lower contact ① ⊖ ⊕ ⊗ ②
	Spring/manual return ① each 45°		1NO+1NC 2NO 2NC 2NO+2NC	AR22J□R-6■11() AR22JY-6■11() AR22J□R-6■20() AR22JY-6■20() AR22J□R-6■02() AR22JY-6■02() AR22J□R-6■22() AR22JY-6■22()		Upper contact ③ ⊖ ⊕ ⊗ ④	Lower contact ① ⊖ ⊕ ⊗ ②
	Spring/manual return ① each 45°		1NO+1NC 2NO 2NC 2NO+2NC	AR22J□R-7■11() AR22JY-7■11() AR22J□R-7■20() AR22JY-7■20() AR22J□R-7■02() AR22JY-7■02() AR22J□R-7■22() AR22JY-7■22()	1NO+1NC (1) (2)	Upper contact ③ ⊖ ⊕ ⊗ ④	Lower contact ① ⊖ ⊕ ⊗ ②
	Spring return ① each 45°		2NO+2NC	AR22J□R-1E22() AR22JY-1E22()	2NO+2NC (1) (2) (3) (4)	Upper contact ① ⊖ ⊕ ⊗ ②	Lower contact ① ⊖ ⊕ ⊗ ②

Notes: • Operator position L:Left, C:Center, R:Right
 • (1) to (4): Contact block mounting position
 • ① - ②, ③ - ④: Contact block terminal No.

● Contact closed

• Contact arrangements

Contact arrangements other than above are available







Contact arrangement	1NO	1NC	1NO+1NC	2NO	2NC	3NO	3NC
Code	10	01	11	20	02	30	03

Contact arrangement	2NO+2NC	4NO	4NC	5NO	5NC	3NO+3NC
Code	22	40	04	50	05	33

• Available numbers of contact blocks

Mainted	Spring return Spring/manual return
6-contact block	4-contact block

• Key removable positions

Code	A	B	C	D	E	F	G
Removable position							
AR22J□R-2	●	●	-	●	-	-	-
AR22J□R-0	●	-	-	-	-	-	-
AR22J□R-3	●	●	●	●	●	●	●
AR22J□R-6	-	-	-	●	●	●	-
AR22J□R-7	●	-	-	-	●	-	●
AR22J□R-1	-	-	-	-	●	-	-

●: Available -: Not available

• Position of contact block

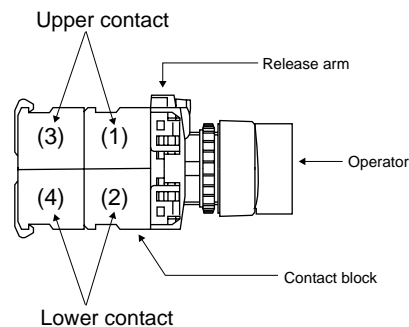

• Key code No.

Replace the () mark with one of the following key code.
 A, B, C, D, E and F
 Standard key code is A.

















• Operator

Replace the □ mark by the cylinder key type code
 Standard type: Blank
 Long durability type: A







Selector Switches AR22

■ Selector switches (control type)

3-position

Operator	Operation	Knob color or key removable position	Contact arrangement	Type	
				Switch with round bezel	Switch with square bezel
Knob  <small>AF94-435</small>	Maintained each 45°	Color code: B: Black (Standard) Color other than above are available (G: Green) (R: Red)	Replace the ■ mark by the contact arrangement code (shown on next page).	AR22PCR-3■B	AR22PCY-3■B
	Spring/manual return  each 45°			AR22PCR-6■B	AR22PCY-6■B
	Spring/manual return  each 45°			AR22PCR-7■B	AR22PCY-7■B
	Spring return  each 45°			AR22PCR-1■B	AR22PCY-1■B
Lever  <small>AF94-436</small>	Maintained each 45°		Replace the ■ mark by the contact arrangement code (shown on next page).	AR22WCR-3■B	AR22WCY-3■B
	Spring/manual return  each 45°			AR22WCR-6■B	AR22WCY-6■B
	Spring/manual return  each 45°			AR22WCR-7■B	AR22WCY-7■B
	Spring return  each 45°			AR22WCR-1■B	AR22WCY-1■B
Cylindrical knob  <small>AF94-433</small>	Maintained each 45°		Replace the ■ mark by the contact arrangement code (shown on next page).	AR22RCR-3■B	AR22RCY-3■B
	Spring/manual return  each 45°			AR22RCR-6■B	AR22RCY-6■B
	Spring/manual return  each 45°			AR22RCR-7■B	AR22RCY-7■B
	Spring return  each 45°			AR22RCR-1■B	AR22RCY-1■B
Key  <small>KKD09-016</small>	Maintained each 45°	Replace the □ mark by the key removable position code: A, B, C, D, E, F or G	Replace the ■ mark by the contact arrangement code (shown on next page).	AR22JCR-3□()	AR22JCY-3□()
	Spring/manual return  each 45°			AR22JCR-6□()	AR22JCY-6□()
	Spring/manual return  each 45°			AR22JCR-7□()	AR22JCY-7□()
	Spring return  each 45°			AR22JCR-1E■()	AR22JCY-1E■()

● Key removable positions

Code	A	B	C	D	E	F	G
Removable position							
AR22JCR-3	●	●	●	●	●	●	●
AR22JCR-6	-	-	-	●	●	●	-
AR22JCR-7	●	-	-	-	●	-	●
AR22JCR-1	-	-	-	-	●	-	-

●: Available -: Not available

● Key code No.

Replace the () mark with one of the following key code.
 A, B, C, D, E and F
 Standard key code is A.

• Contact arrangement code (Typical example)

Contact arrangement	Contact arrangement code	Contact operation				
		Contact block		Operator position		
		Mounting position	Type	Left	Center	Right
2NC	01F	(1)	NC	[Diagram: Solid bar in Center position]		
		(2)	NC	[Diagram: Solid bar in Right position]		
		-	-	-	-	-
		-	-	-	-	-
2NO+2NC	014	(1)	NC	[Diagram: Solid bar in Center position]		
		(2)	NC	[Diagram: Solid bar in Right position]		
		(3)	NO			●
		(4)	NO	●		
4NC	01J	(1)	NC	[Diagram: Solid bar in Center position]		
		(2)	NC	[Diagram: Solid bar in Right position]		
		(3)	NC	[Diagram: Solid bar in Left position]		
		(4)	NC	[Diagram: Solid bar in Right position]		
2NO+2NC	024	(1)	NC	[Diagram: Solid bar in Center position]		
		(2)	NC		●	
		(3)	NO			●
		(4)	NO	●		●
2NO+2NC	03C* (Maintained only)	(1)	NC	[Diagram: Solid bar in Center position]		
		(2)	NC			●
		(3)	NO			●
		(4)	NO	●		
2NO+2NC	044*	(1)	NC	[Diagram: Solid bar in Center position]		
		(2)	NC		●	
		(3)	NO			●
		(4)	NO	●		
2NO+2NC	054	(1)	NC	[Diagram: Solid bar in Center position]		
		(2)	NC		●	
		(3)	NO			●
		(4)	NO			●

Notes: ●: Contact closed Blank: Contact open

* There may be some overlap in the contact when switching between notches.

• Position of contact block

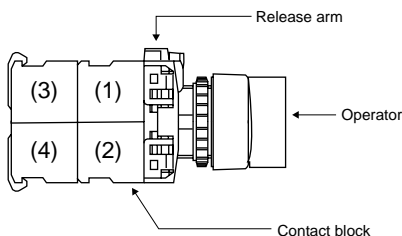

Contact arrangement	Contact arrangement code	Contact operation				
		Contact block		Operator position		
		Mounting position	Type	Left	Center	Right
2NO+2NC	064	(1)	NC		[Diagram: Solid bar in Center position]	
		(2)	NC		●	
		(3)	NO	●		
		(4)	NO	●		●
1NO+1NC	07F	(1)	NC		[Diagram: Solid bar in Center position]	
		(2)	NO			●
		-	-	-	-	-
		-	-	-	-	-
2NO+2NC	07C* (Maintained only)	(1)	NC		[Diagram: Solid bar in Center position]	
		(2)	NC			●
		(3)	NO	●		
		(4)	NO	●		
2NO+2NC	084	(1)	NC		[Diagram: Solid bar in Center position]	
		(2)	NC		●	
		(3)	NO	●		
		(4)	NO	●		
2NO+2NC	094*	(1)	NC		[Diagram: Solid bar in Center position]	
		(2)	NC		●	
		(3)	NO	●		
		(4)	NO			●
2NO+2NC	104	(1)	NC		●	
		(2)	NC		●	
		(3)	NO	●		●
		(4)	NO	●		●
2NO+2NC	11C* (Maintained only)	(1)	NC		●	
		(2)	NC			●
		(3)	NO	●		●
		(4)	NO	●		

04

Selector Switches AR22

• Contact arrangement code (Typical example)

Contact arrangement	Contact arrangement code	Contact operation				
		Contact block		Operator position		
		Mounting position	Type	Left	Center	Right
2NO+2NC	124*	(1)	NC		●	
		(2)	NC		●	
		(3)	NO	●		●
		(4)	NO	●		
2NO+2NC	134*	(1)	NC		●	
		(2)	NC		●	
		(3)	NO	●		●
		(4)	NO			●
3NO+1NC	14D* (Maintained only)	(1)	NO	●		
		(2)	NC		●	
		(3)	NO	●		
		(4)	NO			●
3NO+1NC	15A*	(1)	NO			●
		(2)	NC		●	
		(3)	NO			●
		(4)	NO	●		
2NO+2NC	164	(1)	NC		●	
		(2)	NC		●	
		(3)	NO	●		
		(4)	NO	●		
2NO+2NC	174*	(1)	NC		●	
		(2)	NC		●	
		(3)	NO	●		
		(4)	NO			●
2NO+2NC	184	(1)	NC		●	
		(2)	NC		●	
		(3)	NO			●
		(4)	NO			●

Notes: ●: Contact closed Blank: Contact open

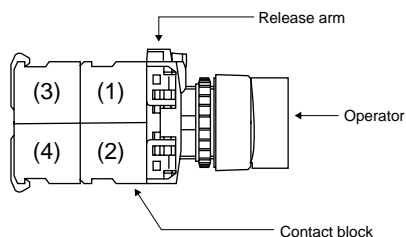

* There may be some overlap in the contact when switching between notches.

• Position of contact block



Contact arrangement	Contact arrangement code	Contact operation				
		Contact block		Operator position		
		Mounting position	Type	Left	Center	Right
2NO+2NC	194	(1)	NC		■■■■	
		(2)	NC	■■■■		
		(3)	NO	●		
		(4)	NO			●
4NO	20B	(1)	NO			●
		(2)	NO	●		
		(3)	NO			●
		(4)	NO	●		

4, 5-position

Operator	Contact (The following contact is only available.)	Operation	Knob color	Contact arrangement	Type	
					Switch with round bezel	Switch with square bezel
Knob  AF94-435	2NO+2NC	4-position maintained	Color code: B: Black (Standard) Color other than above are available (G: Green) (R: Red)	Replace the ■ mark by the contact arrangement code (shown below)	AR22PCR-4■B	AR22PCY-4■B
		5-position maintained			AR22PCR-5■B	AR22PCY-5■B
Lever  AF94-436	2NO+2NC	4-position maintained			AR22WCR-4■B	AR22WCY-4■B
		5-position maintained			AR22WCR-5■B	AR22WCY-5■B
Cylindrical knob  AF94-433	2NO+2NC	4-position maintained			AR22RCR-4■B	AR22RCY-4■B
		5-position maintained			AR22RCR-5■B	AR22RCY-5■B

04

● Contact arrangement code

Position	Contact arrangement	Contact arrangement code	Contact operation		Operator position				
			Contact block		1	2	3	4	5
			Mounting position	Type					
4-position	2NO+2NC	41C* (Maintained only)	(1)	NC			●		
			(2)	NC	●				
			(3)	NO		●			
			(4)	NO				●	
5-position	2NO+2NC	51C* (Maintained only)	(1)	NC				●	
			(2)	NC		●			
			(3)	NO	●				
			(4)	NO					●

● Position of contact block

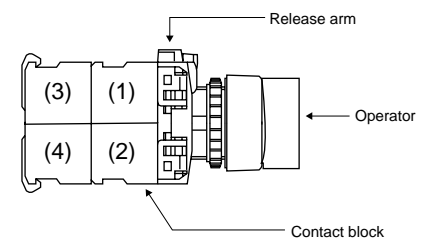

Operator position
4-position 5-position



Notes: ●: Contact closed





* There may be some overlap in the contact when switching between notches.

Illuminated Selector Switches





AR22

■ Illuminated selector switches

2-position

Operator	Operation	Contact	LED lamp		Incandescent lamp		
			Transformer	Type	Transformer	Type	
Knob  <small>AF94-306</small>	Maintained	1NO 1NC 1NO+1NC 2NO+2NC	Without	AR22PL-210■□ AR22PL-201■□ AR22PL-211■□ AR22PL-222■□	Without	AR22PL-210■□ AR22PL-201■□ AR22PL-211■□ AR22PL-222■□	
			With	AR22PL-210■□ AR22PL-201■□ AR22PL-211■□ AR22PL-220■□	With	AR22PL-210■□ AR22PL-201■□ AR22PL-211■□ AR22PL-220■□	
	Spring return  60°	1NO 1NC 1NO+1NC 2NO	Without	AR22PL-010■□ AR22PL-001■□ AR22PL-011■□ AR22PL-020■□	Without	AR22PL-010■□ AR22PL-001■□ AR22PL-011■□ AR22PL-020■□	
			With	AR22PL-010■□ AR22PL-001■□ AR22PL-011■□ AR22PL-020■□	With	AR22PL-010■□ AR22PL-001■□ AR22PL-011■□ AR22PL-020■□	
	Knob with square bezel  <small>AF94-360</small>	Maintained	1NO 1NC 1NO+1NC 2NO+2NC	Without	AR22PP-210■□ AR22PP-201■□ AR22PP-211■□ AR22PP-222■□	Without	AR22PP-210■□ AR22PP-201■□ AR22PP-211■□ AR22PP-222■□
				With	AR22PP-210■□ AR22PP-201■□ AR22PP-211■□ AR22PP-220■□	With	AR22PP-210■□ AR22PP-201■□ AR22PP-211■□ AR22PP-220■□
Spring return  60°		1NO 1NC 1NO+1NC 2NO	Without	AR22PP-010■□ AR22PP-001■□ AR22PP-011■□ AR22PP-020■□	Without	AR22PP-010■□ AR22PP-001■□ AR22PP-011■□ AR22PP-020■□	
			With	AR22PP-010■□ AR22PP-001■□ AR22PP-011■□ AR22PP-020■□	With	AR22PP-010■□ AR22PP-001■□ AR22PP-011■□ AR22PP-020■□	

3-position

Operator	Operation	Contact	LED lamp		Incandescent lamp	
			Transformer	Type	Transformer	Type
Knob  <small>AF94-306</small>	Maintained	1NO+1NC 2NO+2NC	Without	AR22PL-311■□ AR22PL-322■□	Without	AR22PL-311■□ AR22PL-322■□
			With	AR22PL-311■□		AR22PL-311■□
	Spring/manual return  each 45°	1NO+1NC 1NO+1NC	Without	AR22PL-611■□ AR22PL-611■□	Without	AR22PL-611■□ AR22PL-611■□
			With	AR22PL-711■□ AR22PL-711■□	Without	AR22PL-711■□ AR22PL-711■□
Knob with square bezel  <small>AF94-360</small>	Maintained	1NO+1NC 2NO+2NC	Without	AR22PP-311■□ AR22PP-322■□	Without	AR22PP-311■□ AR22PP-322■□
			With	AR22PP-311■□		AR22PP-311■□
	Spring/manual return  each 45°	1NO+1NC 1NO+1NC	Without	AR22PP-611■□ AR22PP-611■□	Without	AR22PP-611■□ AR22PP-611■□
			With	AR22PP-711■□ AR22PP-711■□	Without	AR22PP-711■□ AR22PP-711■□

Note: □, ■ See page 04/33

- Replace the ■ mark by the following lamp voltage code

Transformer	Voltage	Code	
		LED	Incandescent
Without	5V AC/DC	—	5
	6V DC	6	—
	6V AC	A	—
	12V AC/DC	B	—
	15V AC/DC	C	C
	20V AC/DC	—	D
	24V AC/DC	E	E
With	100-110V AC	H	H
	115-127V AC	L	L
	200-220V AC	M	M
	230-254V AC	Q	Q
	350-380V AC	S	S
	400-440V AC	T	T
	480V AC	V	V
	500-550V AC	W	W

- Replace the □ mark by the following knob color code

Color	Green	Red	White	Blue	Yellow	Orange
Code	G	R	W	S	Y	A

- Up to 4-contact of contact arrangement can be made.
Available numbers of contacts are as follow.

No. of position	Operation	Without transformer	With transformer
2-position	Maintained	4-contact	3-contact
	Spring return	3-contact	2-contact
3-position	Maintained	4-contact	3-contact
	Spring/manual return	3-contact	2-contact

- Contact arrangement and operator position

2-position

Transformer	Contact arrangement	Contact block		Operator position	
		Mounting position	Type	Left	Right
With/without	1NO	(1)	NO	—	●
With/without	1NC	(1)	NC	●	—
Without	1NO+1NC	(1)	NO	—	●
		(2)	NC	●	—
With	1NO+1NC	(1)	NC	●	—
		(2)	NO	—	●
With/without	2NO	(1)	NO	—	●
		(2)	NO	—	●
Without	2NO+2NC *1	(1)	NO	—	●
		(2)	NC	●	—
		(3)	NO	—	●
		(4)	NC	●	—

Notes: *1: AR22PL-2, AR22PP-2

●: Contact closed, —: Contact open

3-position

Transformer	Contact arrangement	Contact block		Operator position		
		Mounting position	Type	Left	Center	Right
Without	1NO+1NC *1	(1)	NO	●	—	—
		(2)	NC	—	—	●
	1NO+1NC *2	(1)	NO	—	—	●
		(2)	NC	●	—	—
	2NO+2NC *3	(1)	NO	●	—	—
		(2)	NC	—	—	●
(3)	NO	●	—	—		
(4)	NC	—	—	●		
With	1NO+1NC *1	(1)	NC	—	—	●
		(2)	NO	●	—	—
	1NO+1NC *2	(1)	NC	●	—	—
		(2)	NO	—	—	●

Notes: *1: AR22PL-3, 6 AR22PP-3, 6 *3: AR22PL-3 AR22PP-3

*2: AR22PL-7, AR22PP-7

●: Contact closed, —: Contact open

- Position of contact block

Without transformer

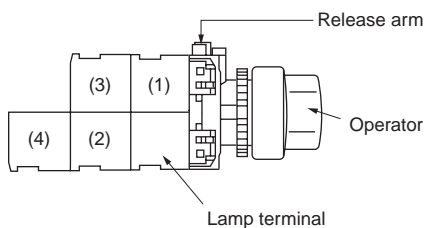



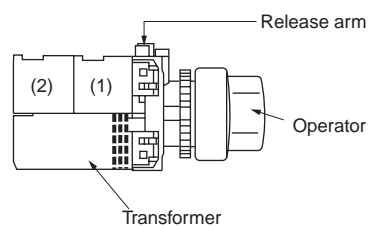





With transformer



Pilot Lights DR22

■ Pilot lights/standard

Lens	Transformer	LED lamp Lamp voltage	Type	Incandescent lamp Lamp voltage	Type
Dome  AF94-333	Without	6V AC 6V DC 12V AC/DC 24V AC/DC	DR22D0L-A3□ DR22D0L-63□ DR22D0L-B3□ DR22D0L-E3□	5.5V AC/DC — 15V AC/DC 24V AC/DC	DR22D0L-54□ — DR22D0L-C4□ DR22D0L-E4□
	With	100–110V AC 200–220V AC	DR22D0L-H3□ DR22D0L-M3□	100–110V AC 200–220V AC	DR22D0L-H4□ DR22D0L-M4□
Extended round  AF94-332	Without	6V AC 6V DC 12V AC/DC 24V AC/DC	DR22E3L-A3□ DR22E3L-63□ DR22E3L-B3□ DR22E3L-E3□	5.5V AC/DC — 15V AC/DC 24V AC/DC	DR22E3L-54□ — DR22E3L-C4□ DR22E3L-E4□
	With	100–110V AC 200–220V AC	DR22E3L-H3□ DR22E3L-M3□	100–110V AC 200–220V AC	DR22E3L-H4□ DR22E3L-M4□
Faceted  AF96-189	Without	6V AC 6V DC 12V AC/DC 24V AC/DC	DR22K0L-A3□ DR22K0L-63□ DR22K0L-B3□ DR22K0L-E3□	5.5V AC/DC — 15V AC/DC 24V AC/DC	DR22K0L-54□ — DR22K0L-C4□ DR22K0L-E4□
	With	100–110V AC 200–220V AC	DR22K0L-H3□ DR22K0L-M3□	100–110V AC 200–220V AC	DR22K0L-H4□ DR22K0L-M4□
Flush square  AF94-330	Without	6V AC 6V DC 12V AC/DC 24V AC/DC	DR22F3M-A3□ DR22F3M-63□ DR22F3M-B3□ DR22F3M-E3□	5.5V AC/DC — 15V AC/DC 24V AC/DC	DR22F3M-54□ — DR22F3M-C4□ DR22F3M-E4□
	With	100–110V AC 200–220V AC	DR22F3M-H3□ DR22F3M-M3□	100–110V AC 200–220V AC	DR22F3M-H4□ DR22F3M-M4□
Flush square (Transparent lens)  AF94-443	Without	6V AC 6V DC 12V AC/DC 24V AC/DC	DR22F4M-A3□ DR22F4M-63□ DR22F4M-B3□ DR22F4M-E3□	5.5V AC/DC — 15V AC/DC 24V AC/DC	DR22F4M-54□ — DR22F4M-C4□ DR22F4M-E4□
	With	100–110V AC 200–220V AC	DR22F4M-H3□ DR22F4M-M3□	100–110V AC 200–220V AC	DR22F4M-H4□ DR22F4M-M4□
Flush square (12mm high frame)  AF94-380	Without	6V AC 6V DC 12V AC/DC 24V AC/DC	DR22F5M-A3□ DR22F5M-63□ DR22F5M-B3□ DR22F5M-E3□	5.5V AC/DC — 15V AC/DC 24V AC/DC	DR22F5M-54□ — DR22F5M-C4□ DR22F5M-E4□
	With	100–110V AC 200–220V AC	DR22F5M-H3□ DR22F5M-E3□	100–110V AC 200–220V AC	DR22F5M-H4□ DR22F5M-M4□
Extended square  AF95-685 AF94-380	Without	6V AC 6V DC 12V AC/DC 24V AC/DC	DR22E3M-A3□ DR22E3M-63□ DR22E3M-B3□ DR22E3M-E3□	5.5V AC/DC — 15V AC/DC 24V AC/DC	DR22E3M-54□ — DR22E3M-C4□ DR22E3M-E4□
	With	100–110V AC 200–220V AC	DR22E3M-H3□ DR22E3M-M3□	100–110V AC 200–220V AC	DR22E3M-H4□ DR22E3M-M4□
Flush rectangular  AF96-237	Without	6V AC 6V DC 12V AC/DC 24V AC/DC	DR22E3N-A3□ DR22E3N-63□ DR22E3N-B3□ DR22E3N-E3□	5.5V AC/DC — 15V AC/DC 24V AC/DC	DR22E3N-54□ — DR22E3N-C4□ DR22E3N-E4□
	With	100–110V AC 200–220V AC	DR22E3N-H3□ DR22E3N-M3□	100–110V AC 200–220V AC	DR22E3N-H4□ DR22E3N-M4□
Extended round with square bezel  AF94-331	Without	6V AC 6V DC 12V AC/DC 24V AC/DC	DR22E3P-A3□ DR22E3P-63□ DR22E3P-B3□ DR22E3P-E3□	5.5V AC/DC — 15V AC/DC 24V AC/DC	DR22E3P-54□ — DR22E3P-C4□ DR22E3P-E4□
	With	100–110V AC 200–220V AC	DR22E3P-H3□ DR22E3P-M3□	100–110V AC 200–220V AC	DR22E3P-H4□ DR22E3P-M4□

Note: □ See page 04/37

■ Pilot lights/short-body without transformer

Lens	LED lamp		Incandescent lamp	
	Lamp voltage	Type	Lamp voltage	Type
 AF98-88	5.5V AC/DC	—	5.5V AC/DC	DR22D0L-58□
	6V AC	DR22D0L-A9□	6V AC	—
	6V DC	DR22D0L-69□	6V DC	—
	12V AC/DC	DR22D0L-B9□	15V AC/DC	DR22D0L-C8□
	24V AC/DC	DR22D0L-E9□	24V AC/DC	DR22D0L-E8□
 AF98-90	5.5V AC/DC	—	5.5V AC/DC	DR22E3L-58□
	6V AC	DR22E3L-A9□	6V AC	—
	6V DC	DR22E3L-69□	6V DC	—
	12V AC/DC	DR22E3L-B9□	15V AC/DC	DR22E3L-C8□
	24V AC/DC	DR22E3L-E9□	24V AC/DC	DR22E3L-E8□
 AF98-89	5.5V AC/DC	—	5.5V AC/DC	DR22K0L-58□
	6V AC	DR22K0L-A9□	6V AC	—
	6V DC	DR22K0L-69□	6V DC	—
	12V AC/DC	DR22K0L-B9□	15V AC/DC	DR22K0L-C8□
	24V AC/DC	DR22K0L-E9□	24V AC/DC	DR22K0L-E8□
 AF98-92	5.5V AC/DC	—	5.5V AC/DC	DR22F3M-58□
	6V AC	DR22F3M-A9□	6V AC	—
	6V DC	DR22F3M-69□	6V DC	—
	12V AC/DC	DR22F3M-B9□	15V AC/DC	DR22F3M-C8□
	24V AC/DC	DR22F3M-E9□	24V AC/DC	DR22F3M-E8□
 AF98-92	5.5V AC/DC	—	5.5V AC/DC	DR22F4M-58□
	6V AC	DR22F4M-A9□	6V AC	—
	6V DC	DR22F4M-69□	6V DC	—
	12V AC/DC	DR22F4M-B9□	15V AC/DC	DR22F4M-C8□
	24V AC/DC	DR22F4M-E9□	24V AC/DC	DR22F4M-E8□
 AF98-94	5.5V AC/DC	—	5.5V AC/DC	DR22F5M-58□
	6V AC	DR22F5M-A9□	6V AC	—
	6V DC	DR22F5M-69□	6V DC	—
	12V AC/DC	DR22F5M-B9□	15V AC/DC	DR22F5M-C8□
	24V AC/DC	DR22F5M-E9□	24V AC/DC	DR22F5M-E8□
 AF98-93	5.5V AC/DC	—	5.5V AC/DC	DR22E3M-58□
	6V AC	DR22E3M-A9□	6V AC	—
	6V DC	DR22E3M-69□	6V DC	—
	12V AC/DC	DR22E3M-B9□	15V AC/DC	DR22E3M-C8□
	24V AC/DC	DR22E3M-E9□	24V AC/DC	DR22E3M-E8□
 KK02-234B	5.5V AC/DC	—	5.5V AC/DC	DR22E3N-58□
	6V AC	DR22E3N-A9□	6V AC	—
	6V DC	DR22E3N-69□	6V DC	—
	12V AC/DC	DR22E3N-B9□	15V AC/DC	DR22E3N-C8□
	24V AC/DC	DR22E3N-E9□	24V AC/DC	DR22E3N-E8□
 AF98-91	5.5V AC/DC	—	5.5V AC/DC	DR22E3P-58□
	6V AC	DR22E3P-A9□	6V AC	—
	6V DC	DR22E3P-69□	6V DC	—
	12V AC/DC	DR22E3P-B9□	15V AC/DC	DR22E3P-C8□
	24V AC/DC	DR22E3P-E9□	24V AC/DC	DR22E3P-E8□

Note: □ See page 04/37

Pilot Lights DR22

■ Pilot lights/short-body with transformer

Lens	LED lamp		Incandescent lamp	
	Lamp voltage	Type	Lamp voltage	Type
Dome  <small>AF97-137</small>	100–110V AC	DR22D0L-H9 □	100–110V AC	DR22D0L-H8 □
	200–220V AC	DR22D0L-M9 □	200–220V AC	DR22D0L-M8 □
Extended round  <small>AF97-138</small>	100–110V AC	DR22E3L-H9 □	100–110V AC	DR22E3L-H8 □
	200–220V AC	DR22E3L-M9 □	200–220V AC	DR22E3L-M8 □
Faceted  <small>KK02-130A</small>	100–110V AC	DR22K0L-H9 □	100–110V AC	DR22K0L-H8 □
	200–220V AC	DR22K0L-M9 □	200–220V AC	DR22K0L-M8 □
Flush square  <small>AF97-134</small>	100–110V AC	DR22F3M-H9 □	100–110V AC	DR22F3M-H8 □
	200–220V AC	DR22F3M-M9 □	200–220V AC	DR22F3M-M8 □
Flush square (Transparent lens)  <small>AF97-133</small>	100–110V AC	DR22F4M-H9 □	100–110V AC	DR22F4M-H8 □
	200–220V AC	DR22F4M-M9 □	200–220V AC	DR22F4M-M8 □
Flush square (12mm high frame)  <small>AF97-136</small>	100–110V AC	DR22F5M-H9 □	100–110V AC	DR22F5M-H8 □
	200–220V AC	DR22F5M-M9 □	200–220V AC	DR22F5M-M8 □
Extended square  <small>KK02-134A</small>	100–110V AC	DR22E3M-H9 □	100–110V AC	DR22E3M-H8 □
	200–220V AC	DR22E3M-M9 □	200–220V AC	DR22E3M-M8 □
Flush rectangular  <small>KK02-235B</small>	100–110V AC	DR22E3N-H9 □	100–110V AC	DR22E3N-H8 □
	200–220V AC	DR22E3N-M9 □	200–220V AC	DR22E3N-M8 □
Extended round with square bezel  <small>AF97-135</small>	100–110V AC	DR22E3P-H9 □	100–110V AC	DR22E3P-H8 □
	200–220V AC	DR22E3P-M9 □	200–220V AC	DR22E3P-M8 □

Note: □ See page 04/37

• **Lens color**

Replace the □ mark by the following lens color code

Color	Green	Red	White	Blue	Yellow	Orange
Code	G	R	W	S	Y	A

• **Lamp voltage**



Available lamp voltage are as follow.

Description	Voltage	Code		Short-body type	
		Standard type LED	Incandescent	LED	Incandescent
Without transformer	5.5V AC/DC	–	54	–	58
	6V AC	A3	–	A9	–
	6V DC	63	–	69	–
	12V AC/DC	B3	–	B9	–
	15V AC/DC	C3	C4	C9	C8
	20V AC/DC	–	D4	–	D8
	24V AC/DC	E3	E4	E9	E8
With transformer	100-110V AC	H3	H4	H9	H8
	115-127V AC	L3	L4	L9	L8
	200-220V AC	M3	M4	M9	M8
	230-254V AC	Q3	Q4	–	–
	350-380V AC	S3	S4	–	–
	400-440V AC	T3	T4	–	–
	480V AC	V3	V4	–	–
	500-550V AC	W3	W4	–	–
With resistor unit	110V DC	H7	–	–	–

Joy Stick Selector Switches

AR22

■ Joy stick selector switches

Handle	Terminal	Operating directions	Contact arrangement	Type	
				Manual return	Spring return
Ball type without lock  <small>AF97-49</small>	Screw	↑ ↓	1NO × 2	AR22A0N-A0A0B	AR22A5N-A0A0B
			1NO + 1NC × 2	AR22A0N-1010B	AR22A5N-1010B
		↔	1NO × 4	AR22A0N-AAAAB	AR22A5N-AAAAB
			1NO + 1NC × 4	AR22A0N-1111B	AR22A5N-1111B
	Solder/tab	↑ ↓	1NO + 1NC × 2	AR22A0H-1010B	AR22A5H-1010B
			2NO + 2NC × 2	AR22A0H-2020B	AR22A5H-2020B
↔	↑ ↓	1NO + 1NC × 4	AR22A0H-1111B	AR22A5H-1111B	
		2NO + 2NC × 4	AR22A0H-2222B	AR22A5H-2222B	
Ball type with lock  <small>AF97-45</small>	Screw	↑ ↓	1NO × 2	AR22A1N-A0A0B	AR22A6N-A0A0B
			1NO + 1NC × 2	AR22A1N-1010B	AR22A6N-1010B
		↔	1NO × 4	AR22A1N-AAAAB	AR22A6N-AAAAB
			1NO + 1NC × 4	AR22A1N-1111B	AR22A6N-1111B
	Solder/tab	↑ ↓	1NO + 1NC × 2	AR22A1H-1010B	AR22A6H-1010B
			2NO + 2NC × 2	AR22A1H-2020B	AR22A6H-2020B
↔	↑ ↓	1NO + 1NC × 4	AR22A1H-1111B	AR22A6H-1111B	
		2NO + 2NC × 4	AR22A1H-2222B	AR22A6H-2222B	
Rubber cap type without lock  <small>AF97-56</small>	Screw	↑ ↓	1NO × 2	AR22A2N-A0A0B	AR22A7N-A0A0B
			1NO + 1NC × 2	AR22A2N-1010B	AR22A7N-1010B
		↔	1NO × 4	AR22A2N-AAAAB	AR22A7N-AAAAB
			1NO + 1NC × 4	AR22A2N-1111B	AR22A7N-1111B
	Solder/tab	↑ ↓	1NO + 1NC × 2	AR22A2H-1010B	AR22A7H-1010B
			2NO + 2NC × 2	AR22A2H-2020B	AR22A7H-2020B
↔	↑ ↓	1NO + 1NC × 4	AR22A2H-1111B	AR22A7H-1111B	
		2NO + 2NC × 4	AR22A2H-2222B	AR22A7H-2222B	

● Operating direction

- Directions other than those shown in the table above can be provided.
- For types AR22A□N-**1** **2** **3** **4** B, designate the contact arrangement codes for the necessary operating directions (**1**: Upper, **2**: Right, **3**: Lower, **4**: Left). Designate "0" for unnecessary directions.

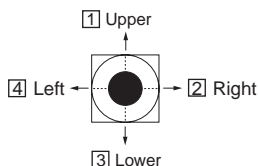



● Contact arrangement

Contact arrangement		–	1NO	1NC	1NO+1NC	2NO	2NC	2NO+2NC
Manual return Spring return	Screw	0	A	B	1	D	E	–
	Solder/Tab	0	–	–	1	–	–	2

- Spring/manual return are also available, contact FUJI.

■ Buzzers

Sound	Description	Transformer	Operating voltage	Type
 KKD08-053	<ul style="list-style-type: none"> • LED operation indicator (Red) • Intermittent/continuous sound selection • Sound level: 90dB (0.1m) 70dB (1m) 	Without	6V AC 6V DC 12 to 24V AC/DC 35 to 48V AC/DC	DR22B5-AB DR22B5-6B DR22B5-EB DR22B5-FB
		With	100 to 110V AC 200 to 220V AC	DR22B5-HB DR22B5-MB
		With resistor unit	100 to 110V DC	DR22B5-1B
 AF96-376	<ul style="list-style-type: none"> • Sound volume adjustment • Sound level: 80 to 90dB (0.1m) 60 to 70dB (1m) 	Without	24V AC/DC	DR22B3-EB
		With	100 to 110V AC 200 to 220V AC	DR22B3-HB DR22B3-MB
 AF96-244	<ul style="list-style-type: none"> • Intermittent/continuous sound selection • Sound level: 80dB (0.1m) 60dB (1m) 	Without	6V AC 6V DC 12 to 24V AC/DC 35 to 48V AC/DC	DR22B8-AB DR22B8-6B DR22B8-EB DR22B8-FB
		With	100 to 110V AC 200 to 220V AC	DR22B8-HB DR22B8-MB
		With resistor unit	100 to 110V DC	DR22B8-1B

- Notes:
- Intermittent/continuous sound selection (DR22B5, B8)
See the "Short-circuit terminal" in the dimensions diagram on the 04/49 page, and select as follows:
 - Short-circuit terminal mounted → Intermittent sound
 - Short-circuit terminal not mounted → Continuous sound

- Sound volume adjustment (DR22B3)
Use a flat-bladed screwdriver with a narrow tip to gently turn "Control knob" shown in the dimensions diagram on the 04/49 page, as follows.
 - Clockwise → Increase sound pressure
 - Counterclockwise → Decrease sound pressure

04

Pushbuttons/Selectors/Pilot Lights/Buzzers

AR22 and DR22

Dimensions

■ Dimensions, mm

● Illuminated pushbutton switches

Flush/Extended

With transformer

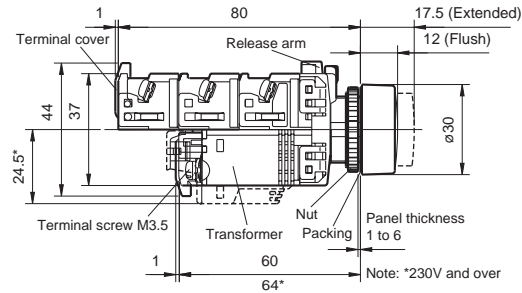

AR22F0L, F5L
AR22E0L, E5L

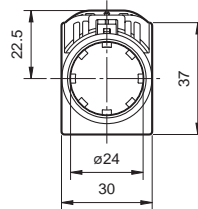

AR22F0M, F5M
AR22E0M, E5M

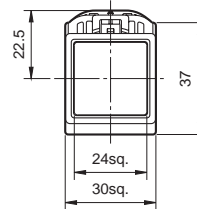

AR22F0P, F5P
AR22E0P, E5P

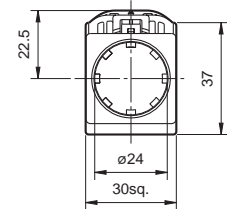

Without transformer

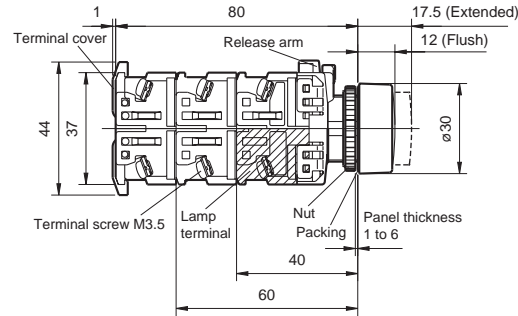

Mushroom (40mm dia.)

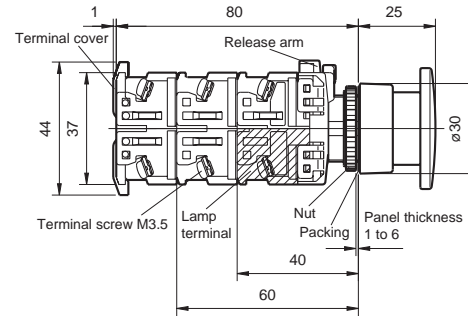

AR22M0L, M5L

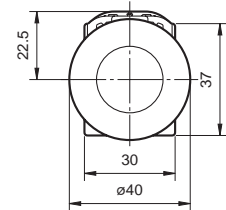

Mushroom (29mm dia.)

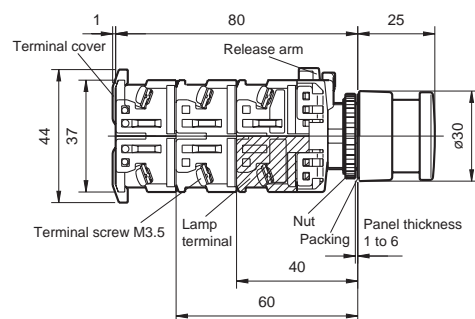

AR22M4L, M9L

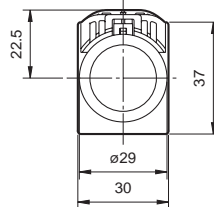

AR22M4P

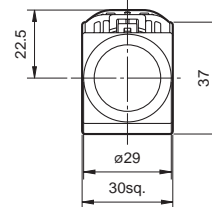

Extended with full guard

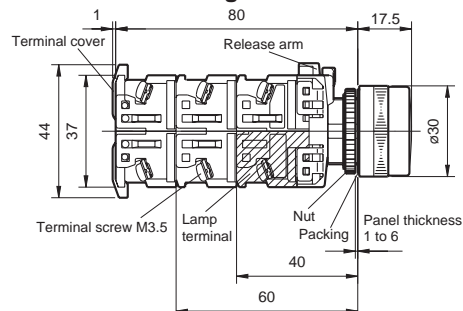

AR22G4L, G9L
AR22G1L, G6L

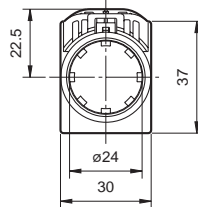

Extended with full guard (with openings)

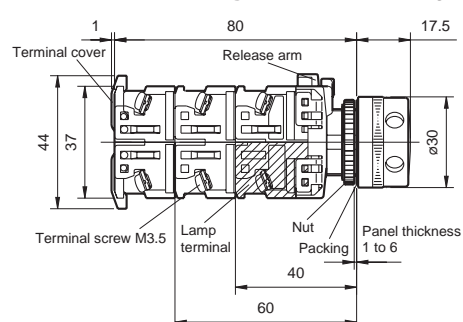

AR22G2L, G7L

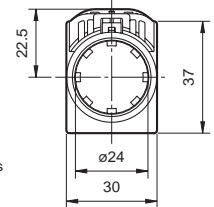

Push-lock, turn-reset

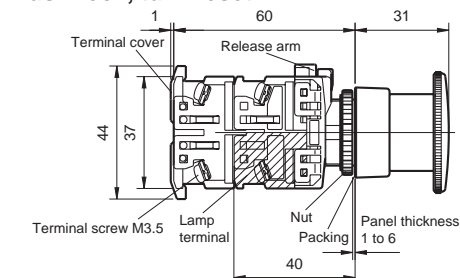

AR22V5L

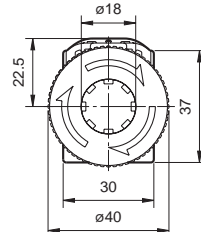

Pushbuttons/Selectors/Pilot Lights/Buzzers AR22 and DR22 Dimensions

■ Dimensions, mm ● Pushbutton switches

Flush/Extended

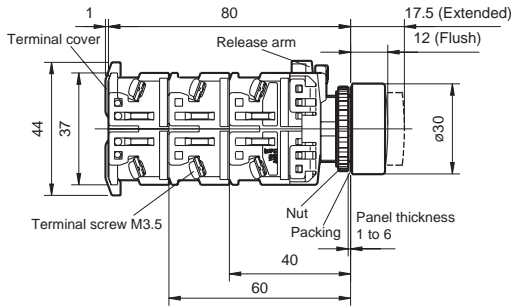

AR22F0R, F5R
AR22E0R, E5R
AR22FAR, FBR
AR22EAR, EBR

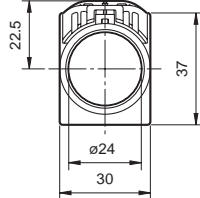

AR22F0S, F5S
AR22E0S, E5S

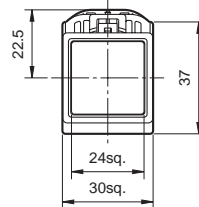

AR22F0Y, F5Y
AR22E0Y, E5Y

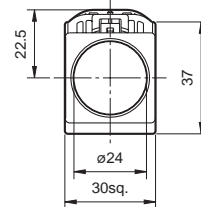

Mushroom (40mm dia.)

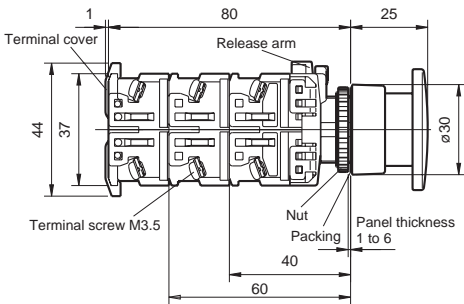

AR22M0R, M5R

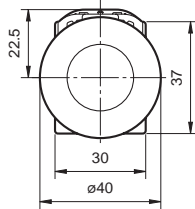

Flush/Extended with full guard

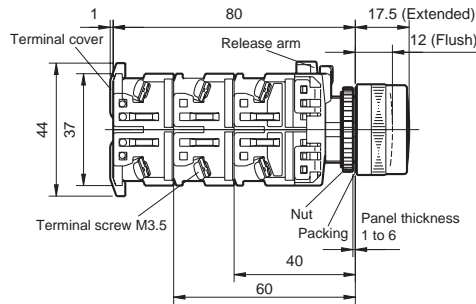

AR22G3R, G8R
AR22G2R, G7R

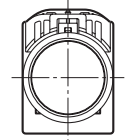

Mushroom (29mm dia.)

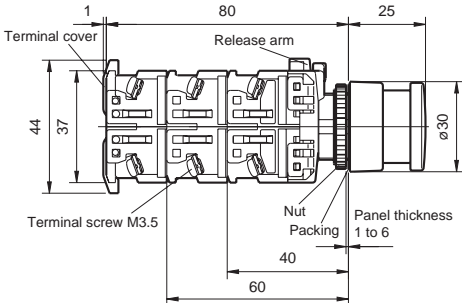

AR22M4R, M9R

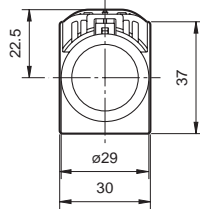

AR22M4Y

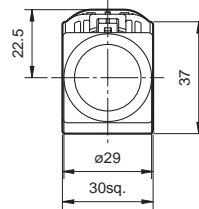

Extended with half guard

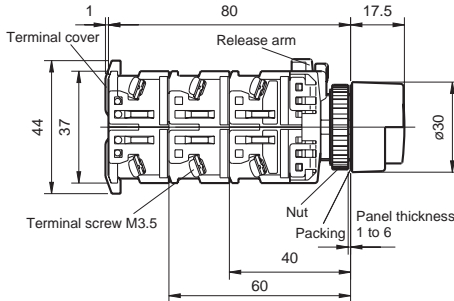

AR22G0R, G5R

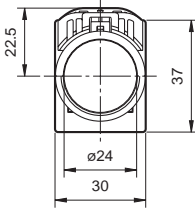

Mushroom with full guard (40mm dia.)

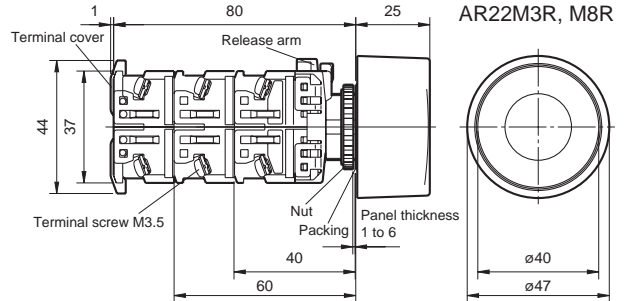

AR22M3R, M8R

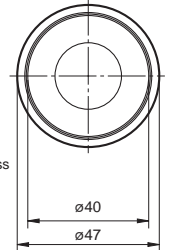

Pushbutton with selector ring

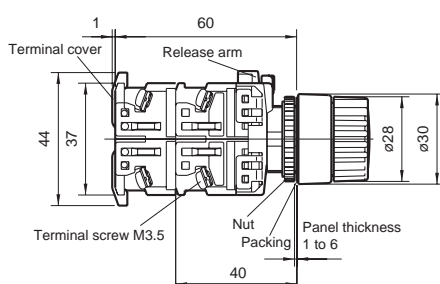

AR22S1R, S2R
AR22S3R, S6R

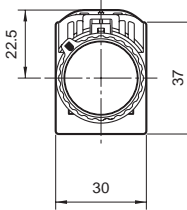

Push-lock, turn-reset

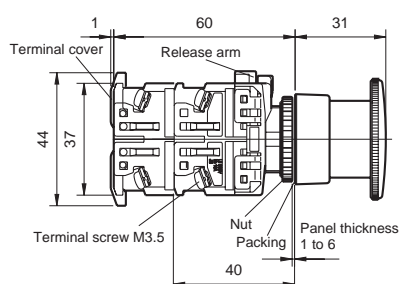

AR22V5R

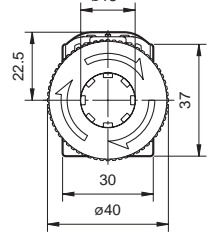

Pushbuttons/Selectors/Pilot Lights/Buzzers AR22 and DR22 Dimensions

■ Dimensions, mm

● Emergency stop pushbutton switches

Push-lock, turn-reset (40mm dia.)

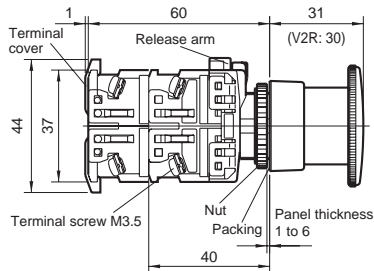

AR22V0R, V2R

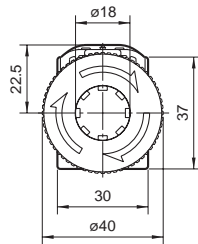

Push-lock, turn-reset (29mm dia.)

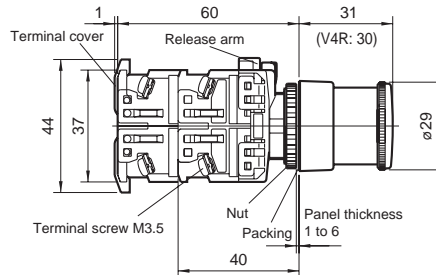

AR22VSR, V4R

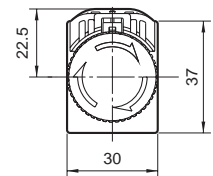

Key release push-lock, turn-reset (40mm dia.)

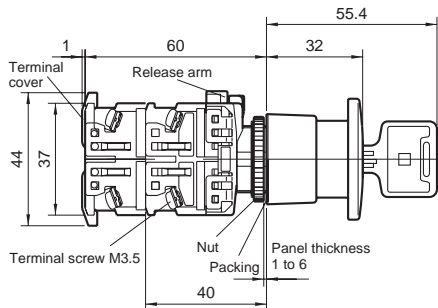

AR22V7R

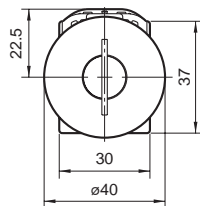

Push-lock, pull-reset (35mm dia.)

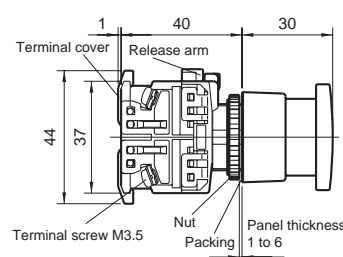

AR22Q2R

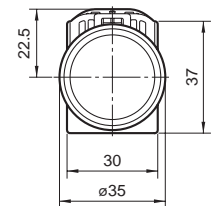

Unibody push-lock, turn-reset (40mm dia.)

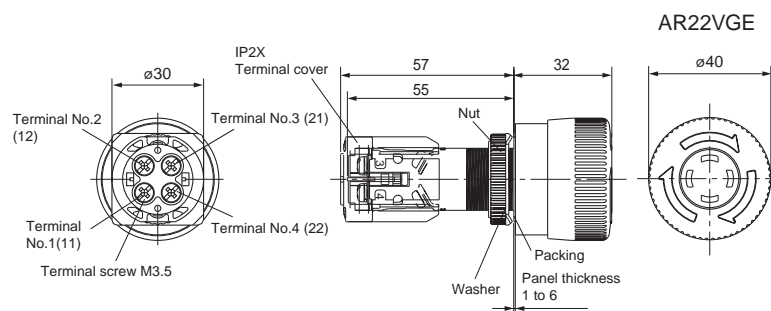

AR22VGE

Wiring diagrams

1NC

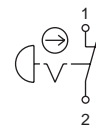

2NC

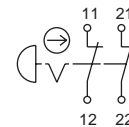

1NO+1NC

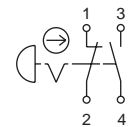

Note: Terminal No. shown in () are for contact arrangement 2NC.

■ Dimensions, mm
 ● Emergency stop illuminated pushbutton switches

Push-lock, turn-reset (40mm dia.)

With transformer

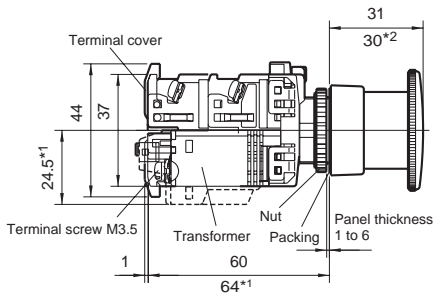

AR22V0L, V2L
 AR22VDL, VAL

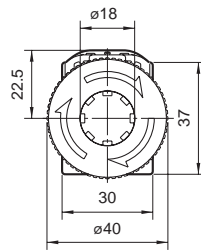

Without transformer

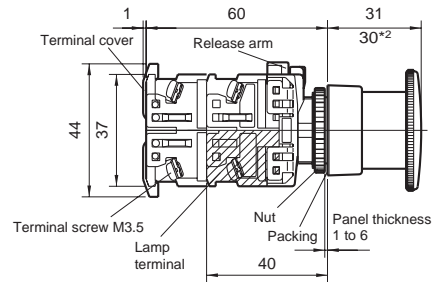

Note: *1 230V and over
 *2 AR22V2L and VAL types only

Push-lock, turn-reset (29mm dia.)

Without transformer

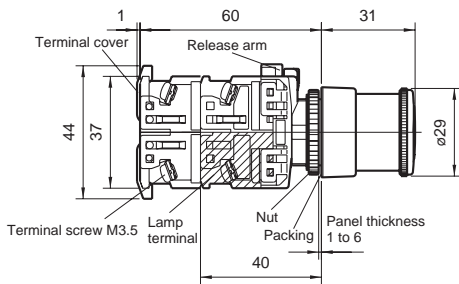

AR22VSL

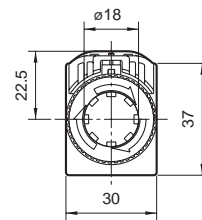

Unibody push-lock, turn-reset (40mm dia.)

Without transformer

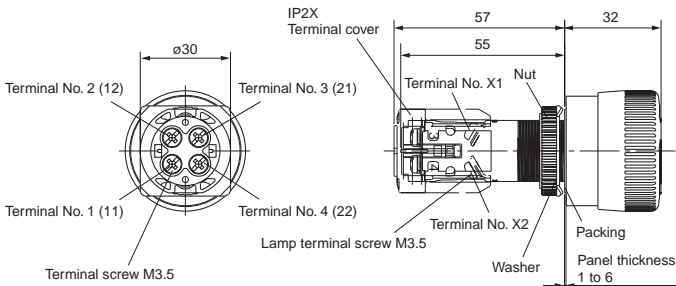

AR22VGF

Wiring diagrams

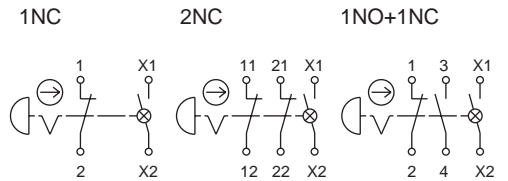

Note: Terminal No. shown in () are for contact arrangement 2NC.

Pushbuttons/Selectors/Pilot Lights/Buzzers

AR22 and DR22

Dimensions

■ Dimensions, mm
● Selector switches

Knob

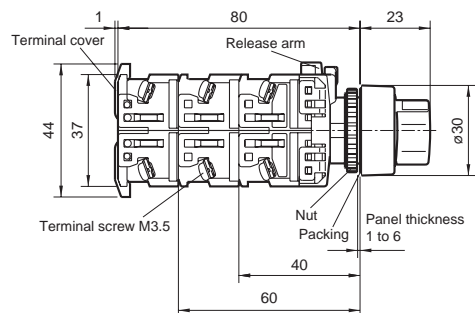

AR22PR, PCR

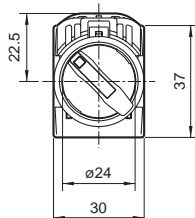

AR22PY, PCY

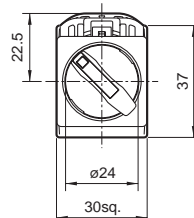

Lever

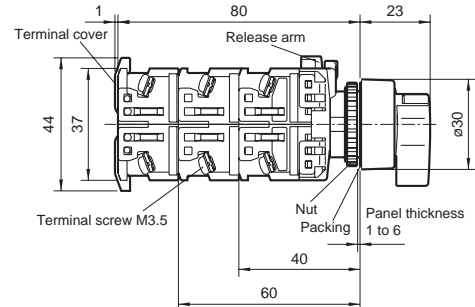

AR22WR, WCR

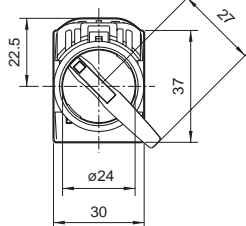

AR22WY, WCY

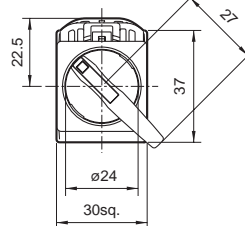

Cylindrical knob

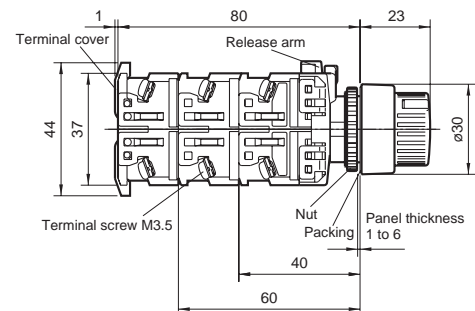

AR22RR, RCR

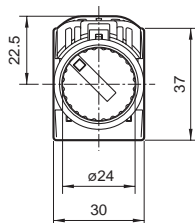

AR22RY, RCY

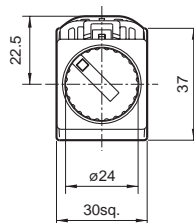

Key

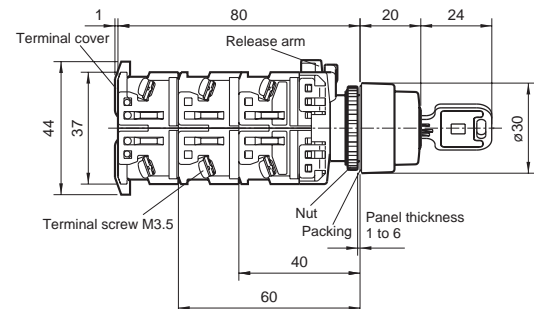

AR22JR, JCR
AR22JAR

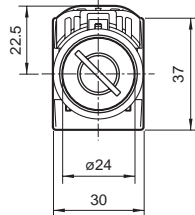

AR22JY, JCY

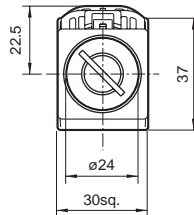

■ **Dimensions, mm**

● **Illuminated selector switches**

With transformer

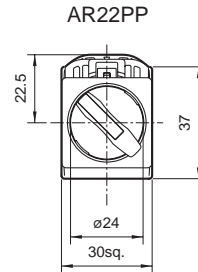
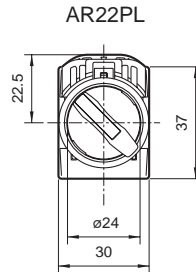
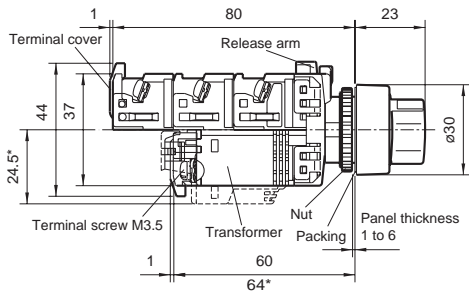

Note: * 230V and over

Without transformer

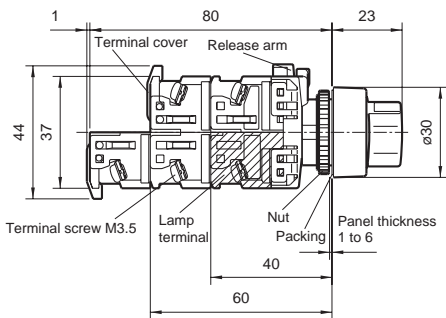

● **Pilot lights**

Dome

With transformer, with resistor unit

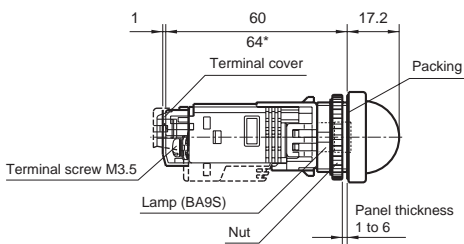

DR22D0L



Without transformer

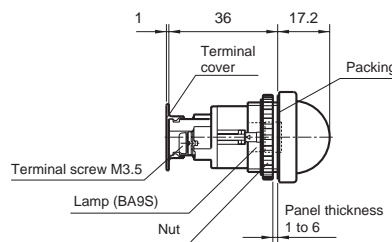

DR22D0L



Short body/with transformer

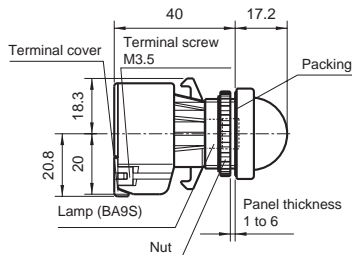

DR22D0L

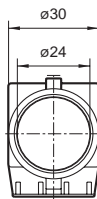

Short body/without transformer

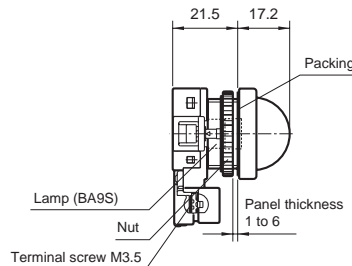

DR22D0L

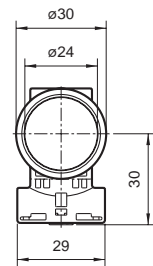

Note: * Except for the types 110V AC, 127V AC and 220V AC.

Pushbuttons/Selectors/Pilot Lights/Buzzers

AR22 and DR22

Dimensions

■ Dimensions, mm
● Pilot lights

Extended

With transformer, with resistor unit

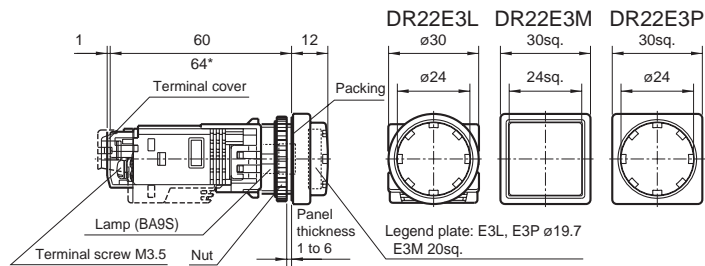

Without transformer

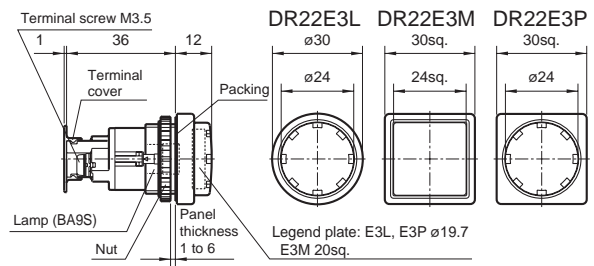

Short body/with transformer

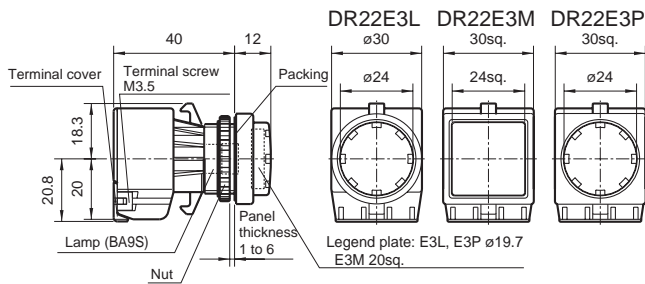

Short body/without transformer

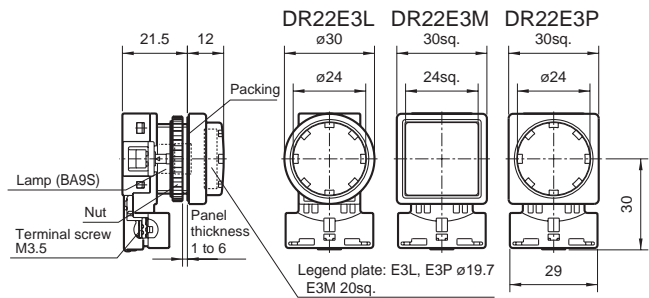

Note: * Except for the types 110V AC, 127V AC and 220V AC.

Faceted

With transformer, with resistor unit

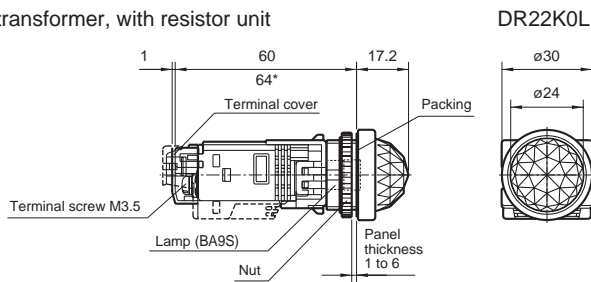

Without transformer

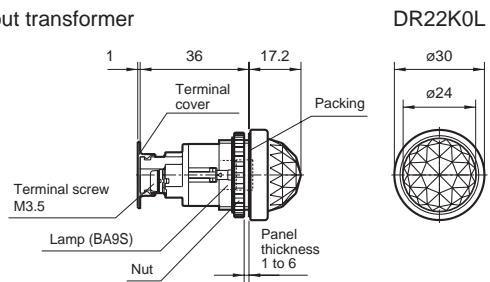

Short body/with transformer

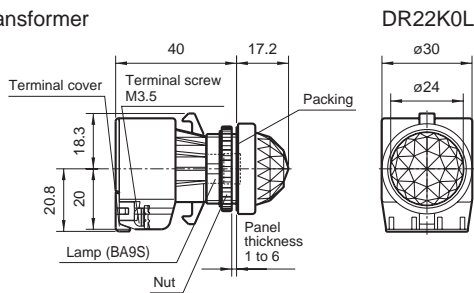

Short body/without transformer

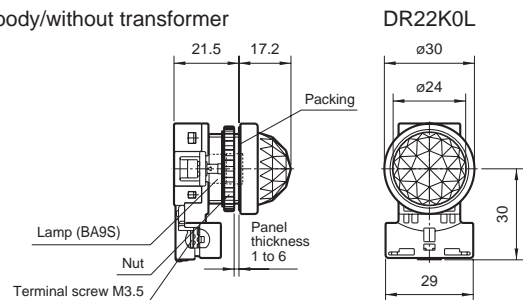

Note: * Except for the types 110V AC, 127V AC and 220V AC.

Pushbuttons/Selectors/Pilot Lights/Buzzers AR22 and DR22 Dimensions

■ Dimensions, mm ● Pilot lights

Flush

With transformer, with resistor unit

DR22F3M, F4M

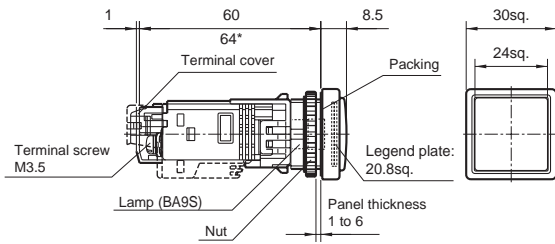

Without transformer

DR22F3M, F4M

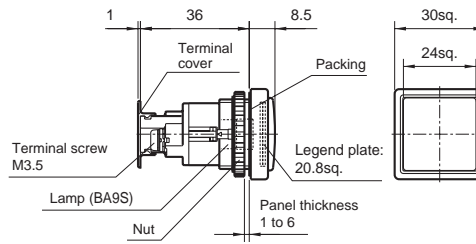

Short body/with transformer

DR22F3M, F4M

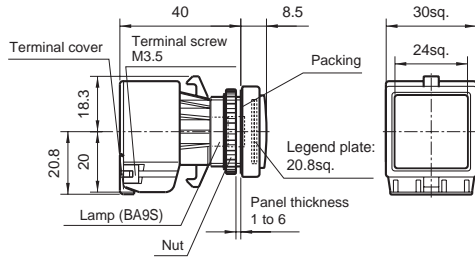

Short body/without transformer

DR22F3M, F4M

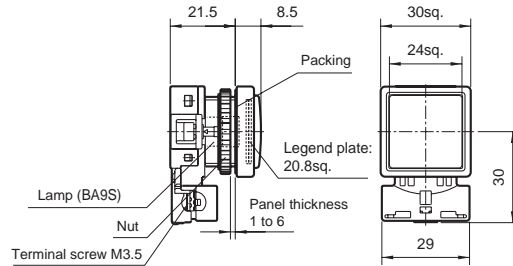

Note: * Except for the types 110V AC, 127V AC and 220V AC.

Flush (12mm high frame)

With transformer, with resistor unit

DR22F5M

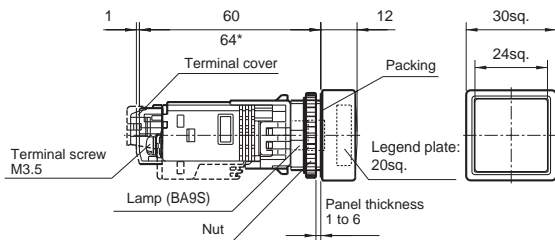

Without transformer

DR22F5M

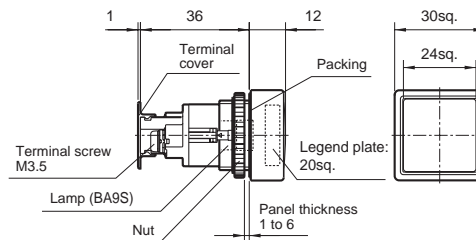

Short body/with transformer

DR22F5M

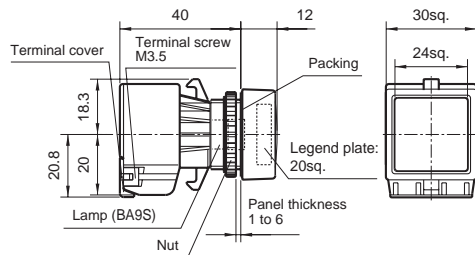

Short body/without transformer

DR22F5M

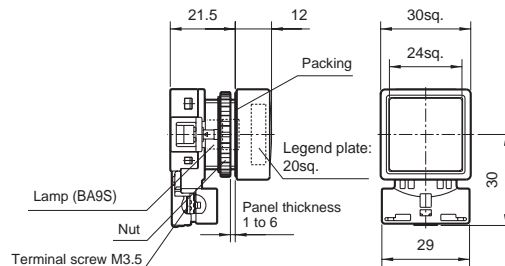

Note: * Except for the types 110V AC, 127V AC and 220V AC.

Pushbuttons/Selectors/Pilot Lights/Buzzers

AR22 and DR22

Dimensions

■ Dimensions, mm
● Pilot lights

Flush rectangular

With transformer, with resistor unit

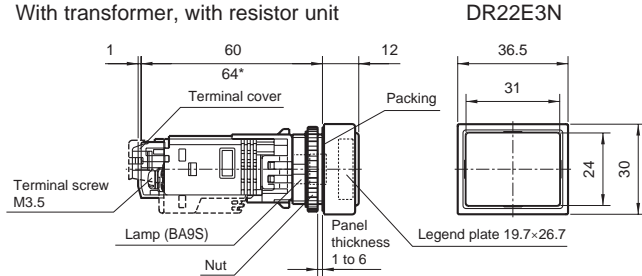

Without transformer

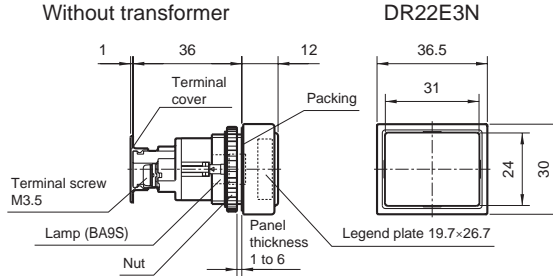

Short body/with transformer

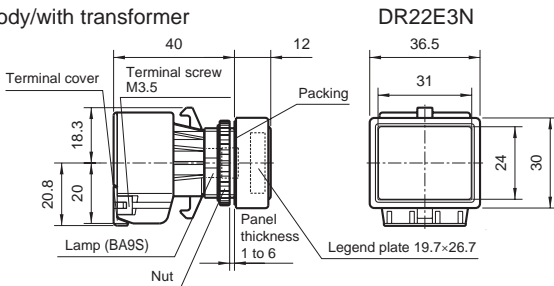

Short body/without transformer

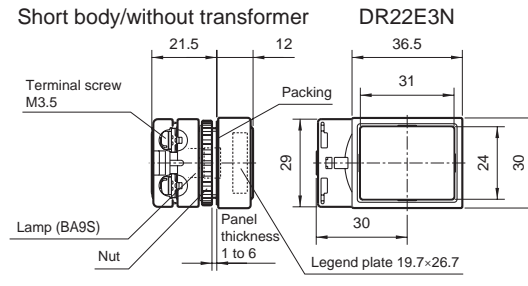

Note: * Except for the types 110V AC, 127V AC and 220V AC.

● Joy stick selector switches

Ball type without lock

Screw terminal AR22A0N, A5N

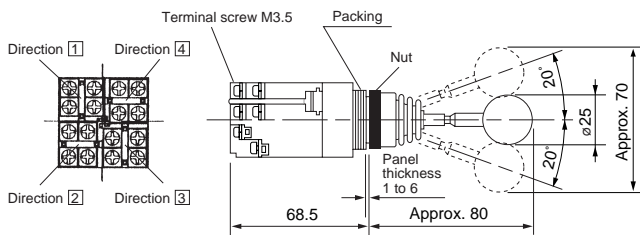

Solder/tab terminal AR22A0H, A5H

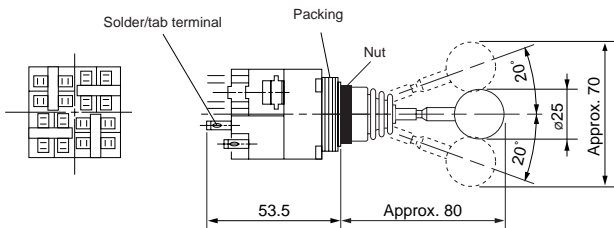

Notes * The contact arrangement is operable in the designated direction by pulling the lock piece in the central position with the fingers. The lock piece will return automatically and locks when the lock piece is released in the central position. The lock piece locks in the central position only.

Ball type with lock

Screw terminal AR22A1N, A6N

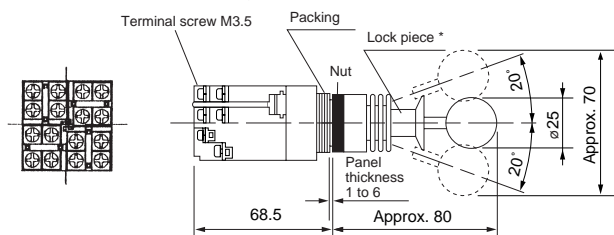

Solder/tab terminal AR22A1H, A6H

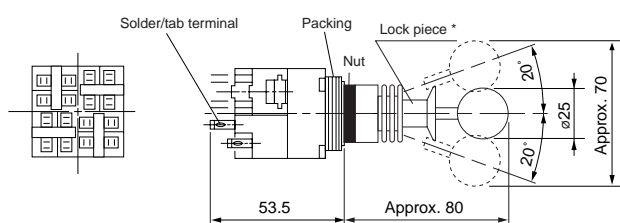

■ **Dimensions, mm**

● **Joy stick selector switches**

Rubber cap type without lock

Screw terminal AR22A2N, A7N

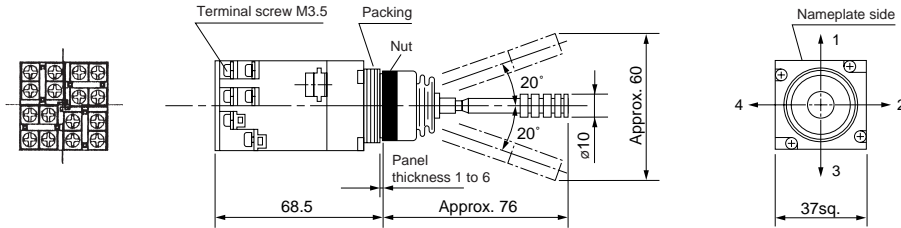

Solder/tab terminal AR22A2H, A7H

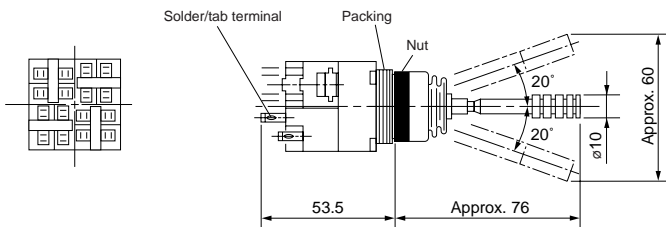

● **Buzzers**

Electronic sound

With transformer

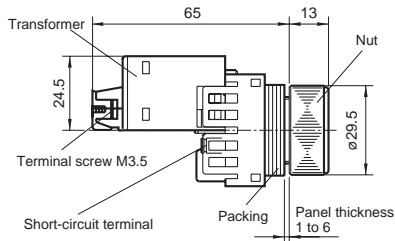

DR22B5

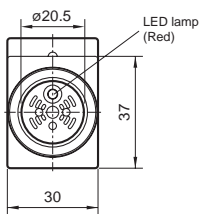

Without transformer

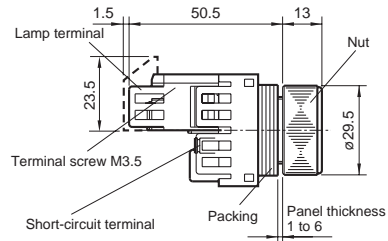

DR22B5

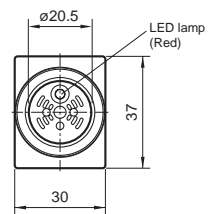

Magnetic sound

With transformer

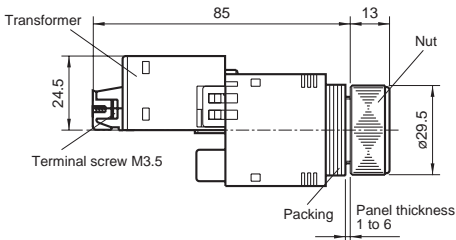

DR22B3

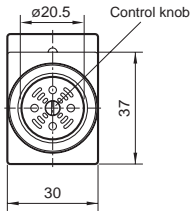

Without transformer

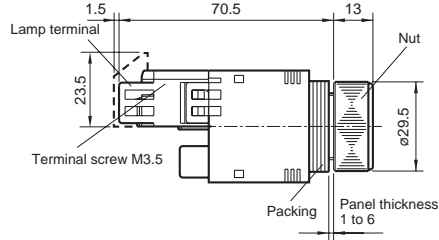

DR22B3

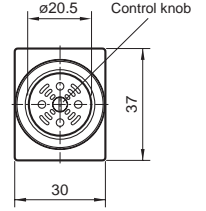

Electronic sound (IP54)

With transformer

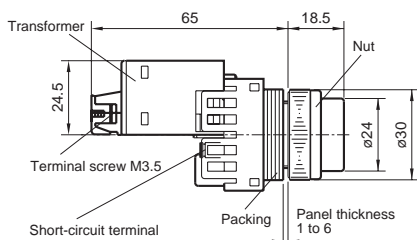

DR22B8

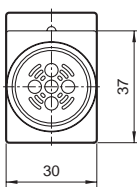

Without transformer

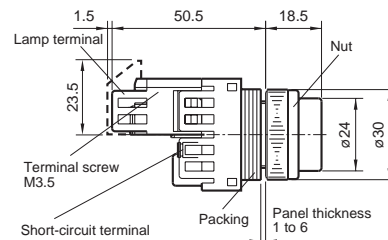

DR22B8

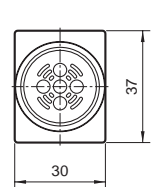

Pushbuttons/Selectors/Pilot Lights/Buzzers AR22 and DR22 Notes on use

Notes on use

■ Fit two sizes of panel cutout holes

* The unique nut with a step allows switch to be mounted in either 22.3mm- or 25.5mm-dia. holes as shown in Fig. 1 without any extra adapter.

Fig. 1 Panel cutout

The switch mounted as a $\phi 22$ mm diameter unit.

The switch mounted as a $\phi 25$ mm diameter unit.

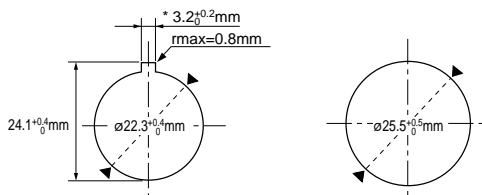

Note: * If key-washer or legend plate are not used, 3.2mm-wide location holes need not be cutout.

■ Detaching contact block from the operator

While keeping the white release arm pressed with one finger, pull-out the contact block in the direction by the arrow.

Fig. 2 Detaching contact block from the operator

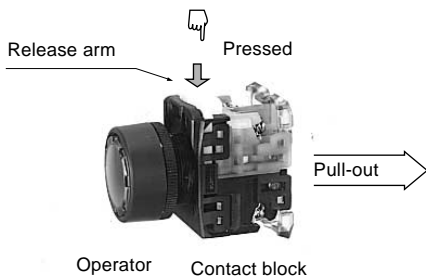

■ Mounting operator to panel

① In a 22.3mm-dia. panel cutout hole
Insert the operator into the cutout hole from the panel front as shown in the Fig. 3.
Then, fit section "A" of the AR9A004 wrench from behind the panel and secure the operator with nut. (See page 04/108 for the wrench)

Fig. 3 Mounting an operator in a 22.3mm-dia. hole

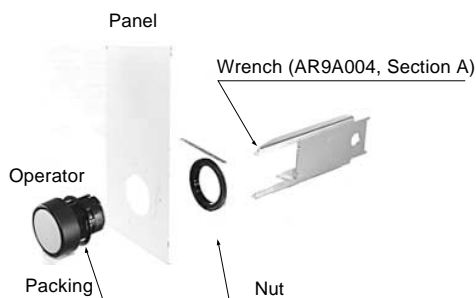

Note: Recommended tightening torque is from 1 to 1.5N•m

② In a 25.5mm-dia. panel cutout hole

As shown in Fig. 4, with the nut step-out side oriented to the panel, use the wrench to tighten the nut and secure the operator.

Fig. 4 Mounting a operator in a 25.5mm-dia. hole

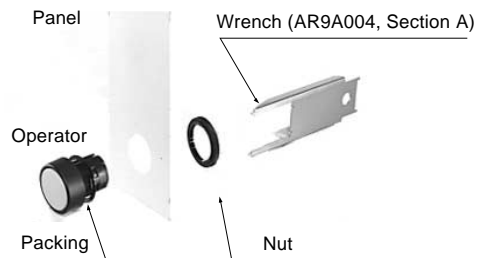

Note: 1. Recommended tightening torque is from 1 to 1.5N•m
2. Ensure that the step-out portion of the nut is correctly fitted in the cutout hole.

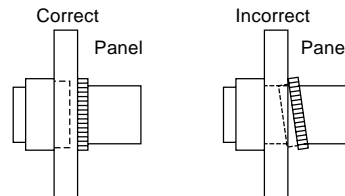

For easier mounting in the 25.5mm-dia. hole, the AR9Y718 adapter is also available separately.

Fig. 5 Mounting with an adapter and locking nut

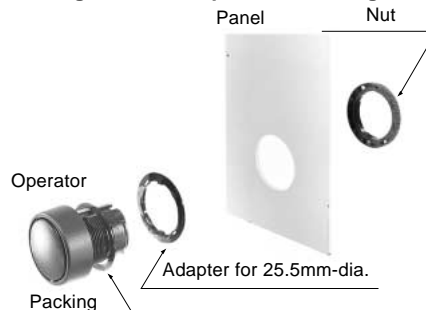

■ Mounting contact block to the operator

As shown in Fig. 6, align the protruding part of the contact block release arm with the operator groove at the ∇ mark. Then, insert the contact block into the operator until it clicks.

Fig. 6 Mounting the contact block to the operator

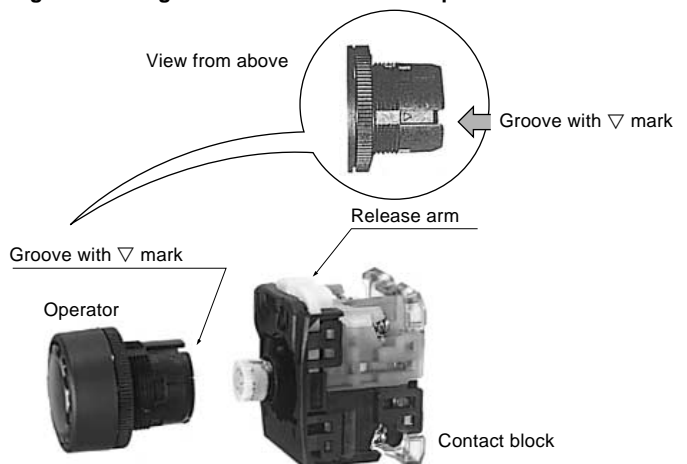

■ **VG type panel mounting**

As shown in the illustration, remove the live section cover, nut, and washer, and insert the main unit into a panel which has been cut from the front side of the panel. Place the type number AR22 facing upward, and secure the main unit with the nut using a wrench AHX701. The appropriate tightening torque is 1 to 1.5N•m.

Fig. 7

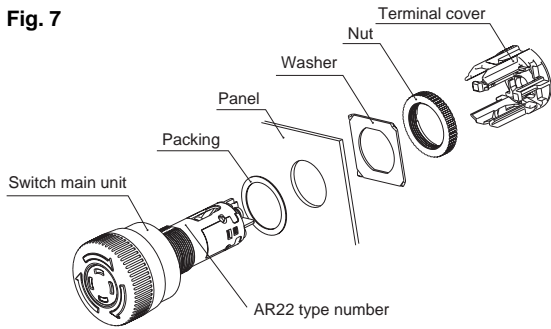

■ **Joy stick selector switch mounting on panel**

- (1) Twist and remove the ball from the operator.
 - (2) Loosen the nut and remove the switch if the switch is provided with a lock.
 - (3) If no locking nut is provided, loosen the nut and remove the switch after the packing part (A) shown in the illustration is stretched to the lever groove.
 - (4) Mount the switch in the order opposite to removal. Set the packing to the notch on the lever as a reference. Do not separate the nut from the packing.
 - (5) Use a torque wrench AR9A006 to tighten the nut from the front of the panel.
- Note: Recommended tightening a torque is 1 to 1.5N•m.

Fig. 8

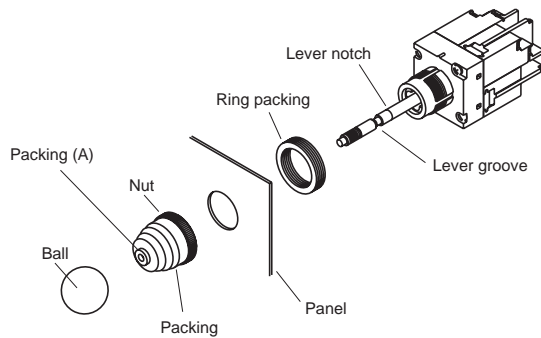

■ **Buzzer mounting on panel**

- (1) Remove the nut, and insert the main unit into the mounting hole from the back of the panel.
- (2) Tighten the buzzer using a wrench AR9A006 from the front side of the panel.

Note:

- Recommended tightening torque is 1 to 1.5N•m.
- Electronic sound (IP54) type has a all-in-one unit with nut and cap.

■ **Applicable panel thickness**

The AR22/DR22 series switches are mountable to panels with thickness as given in Table below.

Mounting condition		Applicable panel thickness (mm)	
Without accessories		1 to 6	
With accessories	Protective cover, water-proof cap, legend plate	1 to 4	
	Key washer	without hole	1 to 4
		with hole	1 to 5
	Adapter for a 25.5mm-dia. hole		1 to 5.5

- When using a joy stick selector switch and buzzer
 The applicable panel thickness is 1 to 6mm. Five 1.3mm packings (single-piece type) are included as standard equipment. Insert as many as required depending on the panel thickness, using the following table as a guide. When using a key washer, legend plate, or adapter, their thickness will have to be added to the values in the guide.

Panel thickness (mm) (plus key washer, legend plate)	Number of packings (reference)
1.0 to 1.6	5
1.6 to 2.8	4
2.8 to 3.8	3
3.8 to 4.8	2
4.8 to 6.0	1

04

Pushbuttons/Selectors/Pilot Lights/Buzzers

AR22 and DR22

Notes on use

■ Minimum mounting space, mm

(1) Minimum mounting space

Fig. 9

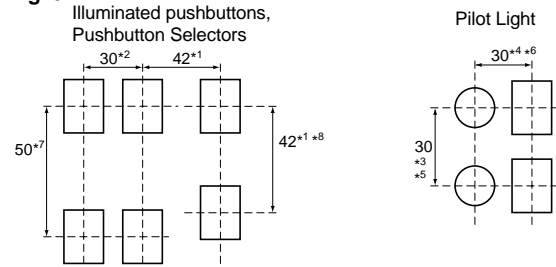

- Notes:
- *1 AR22M0□, M5□, V5□, V0□, V2□, V7R, VG□: 42mm
AR22M3R, M8R: 49mm
AR22Q2R, WR, W0R, WY, WCY: 40mm
 - *2 When mounting contact blocks at 30mm pitch, use it circuit of 380V or less.
 - *3 Short body with transformer types: 50mm.
 - *4 Rectangular types: 36.5mm (except for short body without transformer types).
 - *5 Short body without transformer types: 60mm.
 - *6 Rectangular short body without transformer types: 60mm.
 - *7 This dimension applies when transformer units or contact blocks face each other.
 - *8 This dimension applies when transformer unit or contact block is mounted on only one side.

When mounting operators on a panel, orient all ▽ marks on the operator upwards.

(The operator release arms are oriented upwards.) This aligns the terminals of all contact blocks, thus making wiring easy.

(2) Detaching contact blocks from operators

As shown in Fig. 10, insert a flat-head screw driver into the groove of the white release arm on the contact block. Then, while inserting the driver in hole A of the operator base, lower the driver grip and take out the contact block.

Fig. 10

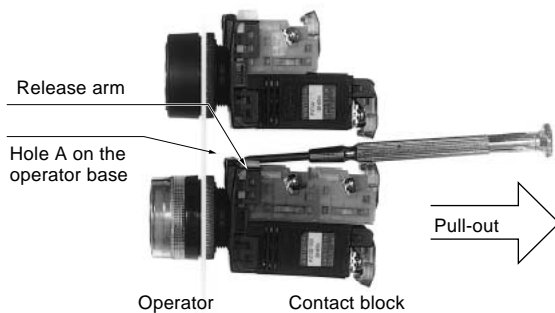

Note: Use a flat head screwdriver as shown at the right.

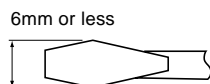

■ Products with blue and green LEDs

The LED devices on products with high-brightness (blue and green) LEDs are very sensitive to static electricity. When replacing LED lamps do not allow static electricity to come into direct contact with the metal frame on the upper side of the LED lamp. The LED device may be damaged if this part is subjected to static electricity. When installing or removing an LED lamp, it is recommended that you use the lamp changer (AHX790).

Fig. 11

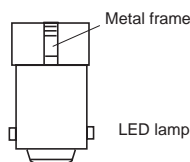

■ Wiring

(1) The terminal screws are M3.5 pan head screws. Solid wires, stranded wires, or crimp terminals can be connected.

Fig. 12

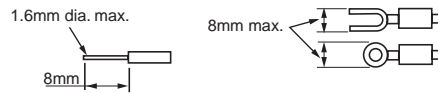

(2) Two crimp terminals can be used by putting one of them on top of the other. If fork-type crimp terminals are used in the horizontal direction, however, use ones as shown in the figure below. (i.e., Toei Tanshi's F2-3.5S or an equivalent).

Fig. 13

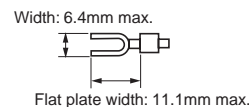

- (3) The terminal washers are a self-lifting type.
- (4) Tighten the terminal screws to a tightening torque of 0.8 to 1N•m.
- (5) Keep the terminals free of external force while wiring or after wiring, or operational failures may result.
- (6) Do not use screws other than the provided terminal screws.

Notes:

- If solid wires are connected to the lamp terminals in the horizontal direction (on the side), be sure to insert the solid wires into the square washers.
- Terminal layout., see page 04/54
- See page 04/53 for the wiring of the joy stick selector switch and VG type.

■ LED Indicator

(1) LED Lamp Malfunctioning

The LED lamp is lit by a very small level of current. Therefore, it may be erroneously lit by a leaking current from the surge absorption circuit or semiconductor circuit or due to stray capacitance between cables. In that case, provide a countermeasure (e.g., connect a resistor in parallel with the LED lamp).

• Countermeasure for Malfunctioning

The LED lamp malfunctions can be prevented by connecting a shunt resistor (R) or CR elements (a capacitor and resistor) in parallel with the LED lamp terminal. The resistance and CR values vary depending on the model and the operating conditions.

Fig. 14

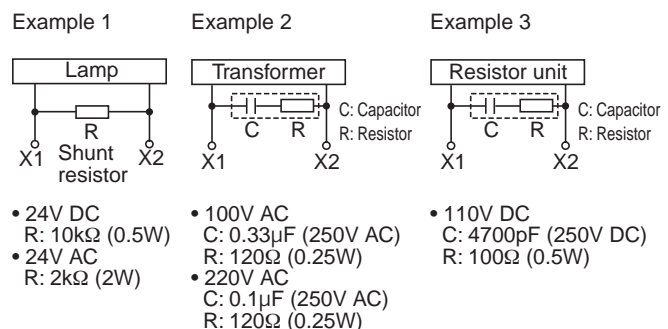

- 24V DC
R: 10kΩ (0.5W)
- 24V AC
R: 2kΩ (2W)
- 100V AC
C: 0.33μF (250V AC)
R: 120Ω (0.25W)
- 220V AC
C: 0.1μF (250V AC)
R: 120Ω (0.25W)
- 110V DC
C: 4700pF (250V DC)
R: 100Ω (0.5W)

(2) Incoming surge

High luminance LED products use an element sensitive to static electricity. They may not be lit by an abnormal voltage like surge. Please note it.

■ Joy stick selector switch

- Screw terminal wiring
- (1) The terminals use M3.5 pan head screws. Use crimp terminals to wire the terminals.

Fig. 15

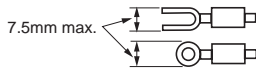

- (2) The terminal washers are a self-lifting type.
- (3) Tighten the terminal screws to a tightening torque of 0.8 to 1.0N•m. Keep the terminals free of external force during and after wiring, or operational failures may result.

• Solder (tab terminal) wiring

- (1) Pay attention to the following items when soldering the terminals.
 - Use a soldering iron with a power consumption of 30W. Use resin-core solder.
 - If a 30W soldering iron is used, finish soldering the terminals within five seconds. If a 20W soldering iron is used, finish soldering the terminals within 10 seconds. Make sure that the soldering iron tip length is at least 20mm long. Do not apply external force to the terminals. Because lead-free solder's melting point is slightly high, soldering work may be difficult. Use a soldering iron whose tip is rather large or whose calorific value is rather high.
- (2) When using adjacent terminals, use insulation tubes to prevent the terminals from short-circuiting. Utmost attention must be paid to the solder terminals if especially thick wires are used or if a large quantity of solder is used.
- (3) Connectable wires
 - Solid wire: 2 wires, 0.8mm dia. max.
 - Stranded wire: 1 wire, 0.75mm² max.
- (4) Use the 110 (2.8mm) series receptacle for the tab terminals.
- (5) Wire the tab terminals with the contact unit connected to the main unit.

• Operation

Operation shall be made after the joy stick operation lever is surely returned to the center position. Do not apply excessive force to the operation lever. The maximum permissible force is 100N.

• Use of contact blocks

If NO and NC contacts are used in the same contact block, check that there is no difference in potential. Do not connect different type of power source different in type.

■ Buzzer

- Noise
- If the application circuit is likely to generate excessively strong noise, connect a surge absorber (e.g., FUJI's ENC390D, provided that the switch is a 24V type) in parallel with the buzzer.
- Place of Use

The buzzer does not have a drip-proof construction. Do not use the buzzer in places where oil or water is sprayed or where dust accumulates. If the buzzer is a splash-proof type, it will resist sprays of water.

- Do not use the buzzer in places that are subject to an excessive amount of corrosive gas.
- Note that the buzzer is likely to sound erroneously due to leakage current or the like.

■ AR22VG type

- As shown in Fig. 16 (a), engage the tip of the wrench (AHX8003) with the groove in the center to mount or remove the locking unit. The recommended tightening torque is 0.6 to 1N•m.

- As shown in Fig. 16 (b), insert the lamp changer (AHX790) and press the lamp changer to mount or remove the lamp. Turn the lamp changer clockwise when mounting the lamp and counterclockwise when removing it.

Fig. 16

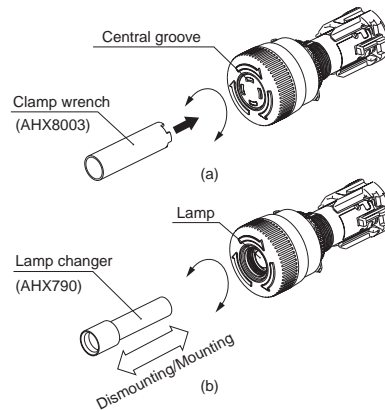

Note: The lamp and neon lamp are special models for the AR22VGF. Use only these special lamps for replacement.

• Wiring

The terminals use M3.5 pan head screws. Use crimp terminals for wiring and cover the crimp terminals with insulation tubes.

Fig. 17

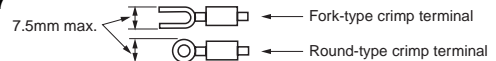

- The terminal washers are a self-lifting type.
- Tighten the terminal screws to a torque of 0.8 to 1N•m. Keep the terminals free of external force during and after wiring, or operational failures may result.
- Wiring precautions
 - (1) Use of round-type crimp terminal
 - Remove the live section cover, and half-tighten to the point parallel with the terminal rib white marks in the direction of the arrows as shown in the illustration below.
 - Mount the live section cover and tighten the terminals securely.

Fig. 18

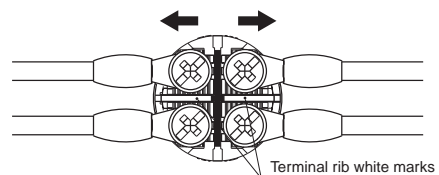

As shown in the illustration below, mount the live section cover so that the mounting legs of the cover engage with the concave parts of the main unit.

Fig. 19

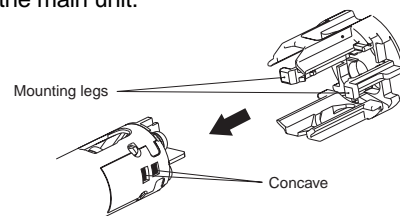

- (2) If fork-type crimp terminals are used, wiring will be possible without removing the live section cover.

Pushbuttons/Selectors/Pilot Lights/Buzzers

AR22 and DR22

Notes on use

■ Operation

- Do not use a hitting or bouncing action to operate the button, or the switch may break. Always operate the switch by hand. Do not pull mushroom head pushbuttons or alternate buttons other than the Q2.
- Do not rotate the selector ring type while the button is pressed, or the mechanism may break.
- The control type incorporates make-before-break contacts. Prepare a protection circuit for the application.
- The dial of the selector switch rotates with a light force. Do not apply force in excess of 1N•m. Please do not pull out or insert the key forcibly.
- To release the lock of the push-lock type, rotate the button clockwise as shown by the arrow. Do not pull the button, or the latch may break and the lock may fail to work.
- Do not lock the emergency stop pushbutton switch and emergency stop illuminated pushbutton switch in use. Push and lock the switch in case of an emergency only.

■ Terminal layout

Fig. 20

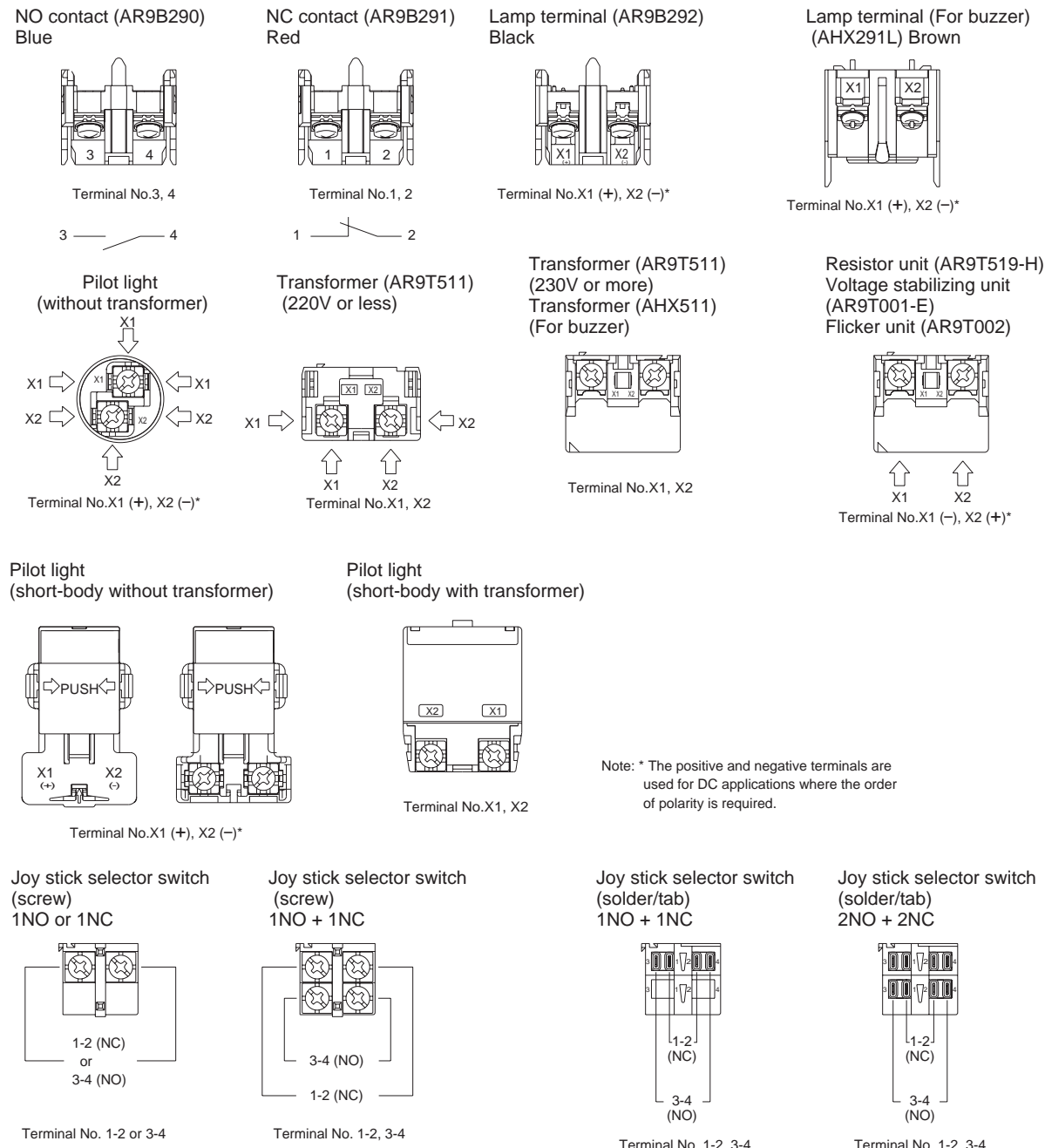









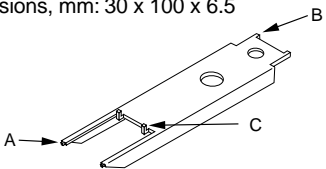





Pushbuttons/Selectors/Pilot Lights





AR22/DR22 and AR30/DR30



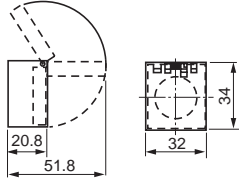

Accessories

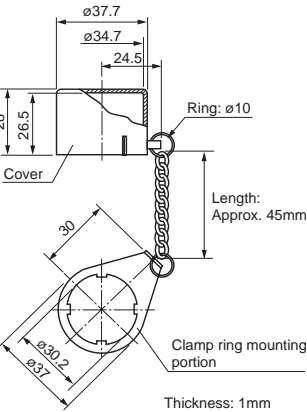
■ Accessories

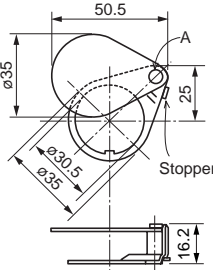
Description	Type
Wrench	<p>AR9A004 Dimensions, mm: 30 x 100 x 6.5</p>  <p>Remarks Section "A" Use this section to tighten the nut for mounting the operator on a panel. Section "B" Use this section to tighten or remove the lens. Applicable type: AR22F0L, F5L, E0L, E5L, F0P, F5P, E0P, E5P AR22G1L, G2L, G4L, G6L, G7L, G9L DR22E3L, E3P AR30E0L, E5L, G2L, G3L, G4L, G7L, G8L, G9L DR30E3L Section "C" Fit the tabs on the section "C" in the center button, and turn the wrench to tighten or remove the button. Applicable type: AR22V (except V4R, VG type) AR30V (except V1R type)</p>  <p>KK02-261</p>
Wrench for AR22, DR22	<p>AR9A701 Dimensions, mm: $\varnothing 28 \times 70$</p> <p>Application: AR22, DR22 nut tightening</p> 
Wrench	<p>AHX536 Dimensions, mm: $\varnothing 32 \times 76$</p> <p>Application: DR30F4M, F4N, M4M, N1, N2 nut tightening</p>  <p>KK02-097A</p>
Wrench	<p>AR9A001 Dimensions, mm: $\varnothing 22 \times 35$</p> <p>Application: AR22, DR22 round-type lens tightening AR22E0M, E5M oil-proof cap tightening AR30, DR30 round-type lens tightening AR30GSR button tightening</p>  <p>KK02-098A</p>
Wrench (for center button)	<p>AR9A002 Dimensions, mm: $\varnothing 18 \times 60$</p> <p>Application: AR22V center button tightening (except V4R, VG type) AR30V center button tightening (except V1R type)</p> 
Wrench	<p>AHX701 Dimensions, mm: $\varnothing 25 \times 72.5$</p> <p>Application: DR22N, AR22VG nut tightening</p>  <p>AF03-5</p>

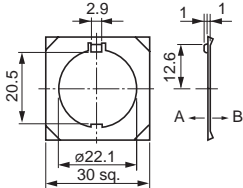
Description	Type
Wrench (for center button)	<p>AHX8003 Dimensions, mm: $\varnothing 14 \times 50$</p> <p>Attaching and removing the center button of the AR22VGF type.</p>  <p>AF93-6</p>
Wrench for AR22,30 and DR22, 30	<p>AR9A006 Dimensions, mm: $\varnothing 40 \times 100$</p> <p>To mount an AR22, 30 or DR22, 30 command switch to a panel, use this wrench to tighten the nut securely. It is very easy to fit this wrench onto the nut. The wrench with an inside rubber-lining can be easily used with either your right or left hand.</p>  <p>For $\varnothing 22$ For $\varnothing 30$</p> <p>AF96-241</p>
Wrench for AR30, DR30	<p>AHX001 Dimensions, mm: $\varnothing 47 \times 100$</p> <p>To mount an AR30 or DR30 command switch to a panel, use this wrench to tighten the nut securely.</p>  <p>AF95-467</p>
Special tool	<p>AHX321 Dimensions, mm: 42 x 130 x 6.5 For all types except pilot lights</p> <p>DR9A321-T Dimensions, mm: 57 x 130 x 30 For pilot lights</p> <ul style="list-style-type: none"> • This tool is used to remove contact blocks and transformer units. • The AHX321 can remove round color lens of switches.  <p>AHX321 SG-873</p>  <p>DR9A321-T AF95-21</p>
Wrench/Lamp changer	<p>AHX702 Dimensions, mm: $\varnothing 36 \times 55$</p> <p>Use this wrench to tighten or remove the lens and lamp.</p> <p>Used with: Lens of DR22D0L, K0L and DR30D0L, K0L Incandescent lamp of pilot lights and illuminated pushbuttons</p>  <p>SI-1030</p>
Lamp changer	<p>AHX790 Dimensions, mm: $\varnothing 14 \times 55$</p> <ul style="list-style-type: none"> • Use this rubber wrench for mounting or removing lamps from pilot lights and illuminated pushbutton switches. • This wrench can be used for both LED and incandescent lamps. • One end is for the BA9S/13 lamp, and the other is for the E12/15 lamp (for use with 30mm dia. pilot lights with resistor). • For 30mm dia. pilot lights with resistor, this tool can also be used to attach or remove incandescent lamps.  <p>For BA9S/13 lamp For E12/15 lamp</p> <p>AF95-22</p>

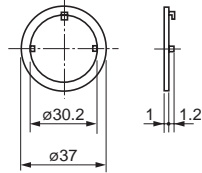

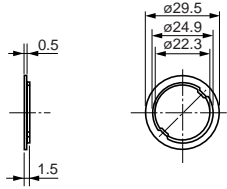
Description	Type
<p>Protection cover</p>  <p>AF95-29</p>	<p>AR9E760</p> <p>This cover protects against accidental operation. The cover lid is returned home with a spring force. (Packing is provided)</p> <p>Used with: AR22F0L, F5L, E0L, E5L, F0M, F5M, E0M, E5M, F0P, F5P, E0P, E5P AR22F0R, F5R, E0R, E5R, F0S, F5S, E0S, E5S, E0Y, E5Y, F0Y, F5Y, FAR, FBR, EAR, EBR</p> <p>Dimensions, mm:</p> 
<p>Cover for preventing operating errors with 30mm dia. types</p>  <p>AF91-671</p>	<p>AR9E538</p> <p>Inadvertent operation can be prevented by fitting a transparent cover with chain in the clamp ring.</p> <p>Used with: AR30F0R, F5R, E0R, E5R, E0L, E5L</p> <p>Dimensions, mm:</p> 
<p>Cover for preventing operating errors with 30mm dia. types</p>  <p>.AF93-420</p>	<p>AHX408</p> <p>This is a metallic cover for preventing inadvertent operation.</p> <p>Used with: AR30F0R, F5R</p> <p>Dimensions, mm:</p>  <p>When attaching the cover to a vertical panel, if you attach it so that the portion indicated by an "A" is at the upper right, the stopper causes the cover to stop above the push button to halt further rotation.</p> <p>The material is steel (zinc plated).</p>

Description	Type
<p>Key washer for AR22, DR22</p>  <p>AF95-25</p>	<p>AR9Y715</p> <p>Use this metal washer when securing a operator in a 22.3mm dia. panel cutout hole.</p> <p>Dimensions, mm:</p>  <ul style="list-style-type: none"> When the periphery of the panel cutout has a hole to stop rotation, use with side A contacting the panel (except for Joy stick selector types). Even when the periphery of the panel cutout does not have a hole to stop rotation, if used with side B contacting the panel it can serve as a washer for eliminating play (except for Joy stick selector types).
<p>Key washer for ø30</p>  <p>SC-1016</p>	<p>AHX082</p> <p>Use this metal washer when securing an operator in a 30.5mm dia. panel cutout hole.</p> <p>Dimension, mm:</p> 
<p>Operator base cover</p>  <p>AF95-26</p>	<p>AR9Y002</p> <p>Attach this cover to the operator base of a pushbutton switch with only one contact block (1NO or 1NC) to protect against dust.</p>
<p>Adapter for AR22, DR22</p>  <p>AF95-28</p>	<p>AR9Y718</p> <p>Use this resin adapter to mount the AR22/DR22 (switch/pilot light) in a 25.5mm dia. cutout hole on a panel.</p> <p>Dimensions, mm:</p> 

Pushbuttons/Selectors/Pilot Lights

AR22/DR22 and AR30/DR30

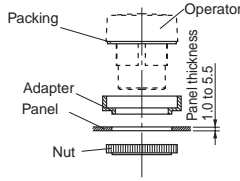
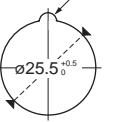
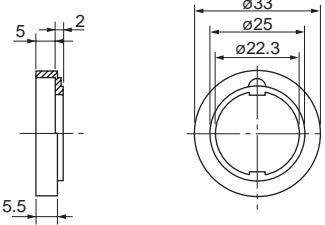
Accessories

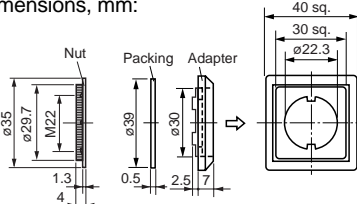
Description	Type
Adapter for AR22 and DR22 	AR9Y008 Use this resin adapter to mount the AR22/DR22 (switch/pilot light) in a 25.5mm dia. cutout hole on a panel. Mounting, mm:  Panel cutout, mm:  Equipped with device for stopping rotation Used with: AR22, DR22 round head types (except for M3R, M8R, VG□, joy stick selectors and buzzers) Dimensions, mm:  AF98-198
Adapter for AR30 and DR30 	AR9Y003 Mount this adapter onto a 22mm dia. command switch with a square button and a square bezel to obtain a 30mm dia. command switch with a square/round button and a square bezel. A resin ring-packing and a nut are accessories of the adapter. Dimensions, mm:  Note: Panel thickness: 2.5 to 5mm AF95-416

Description	Type
Round-frame adapter for 30mm dia. types 	AR9Y004 By using this adapter in combination with the round type 22mm dia. command switch, the 22mm dia. command switch can be used as a 30mm dia. command switch/round frame type. Used with: AR22, DR22 round types (except for M3R, M8R, VG□, Joy stick selectors, buzzers) Dimensions, mm  Note: Panel thickness: 2.5 to 5mm KK02-100A
Round-frame adapter for 30mm dia. type VG 	AHX958 Using this adapter in combination with model AR22VG (22mm dia.) allows mounting to a 30.5mm panel cutout hole. The attachment method is as follows. <ul style="list-style-type: none"> • The washer and nut (22.3mm dia.) originally attached to the operator will not be used, so remove them. • Attach the 22mm dia. packing (included), the 30mm dia. adapter and the 30mm dia. packing to the operator in that order, and insert the operator into the cutout hole. • From the back of the panel cutout hole, fasten the 30mm-dia. nut using the AHX701 wrench. The correct tightening torque is 1 to 1.5 N•m.  *1 Adapter for 30mm dia. (AHX958) Panel cutout, mm:  Dimensions, mm:  Note: Panel thickness: 1 to 6mm AF93-4

Description	Type
Legend plate for AR22	AR9P711-①②③ ① Color B: Black A: Aluminum This aluminum legend plate is for a 22.3mm dia. panel cutout hole. (Packing provided)
	Legend Code ② ③ Blank 0 0 ON 0 A OFF 0 B START 0 C STOP 0 D OFF-ON 2 A
	Dimensions, mm:
SI-1033	

Description	Type
Legend plate for AR22	AR9P712-①②③ ① Color B: Black A: Partially black This aluminum legend plate is for a 22.3mm dia. panel cutout hole. (Packing provided)
	Legend Code ② ③ Blank 0 0 ON 0 A OFF 0 B START 0 C STOP 0 D OFF-ON 2 A
	Dimensions, mm:
SI-1032	

Description	Type
Legend plate for AR22	AR9P713-①②③ ① Color B: Black A: Partially black This aluminum legend plate is for a 22.3mm dia. panel cutout hole. (Packing provided)
	Legend Code ② ③ Blank 0 0 ON 0 A OFF 0 B START 0 C STOP 0 D OFF-ON 2 A
	Dimensions, mm:
AF95-114	

Description	Type
Legend plate for AR22 emergency stop	AR9P719-①② Plate color: Yellow Letter color: Black This aluminum legend plate is for a 22.3mm dia. panel cutout hole. (Packing provided)
	Legend Code Letter height ① ② Blank 0 0 - EMERGENCY 5 A 7mm STOP 5 B 13mm EMERGENCY 5 C 13mm OFF
	Dimensions, mm:
KK02-265A	Note: Engraving for making letters is not available.

Pushbuttons/Selectors/Pilot Lights

AR22/DR22 and AR30/DR30

Accessories

Description	Type
Legend plate for AR22 (width: 34mm)	AR9P015-B ①② : Hight 36mm AR9P014-B ①② : Hight 40.3mm
	Color: black
	Legend code
	① ②
	Blank 0 0
	ON 0 A
	OFF 0 B
	START 0 C
	STOP 0 D
	OFF-ON 2 A
	Optimal for use in combination with a 3-position selector switch. Legend plates are available in two types: short, 36 mm; and long, 40.3mm.
	Dimensions, mm:



.AF96-190

Legend plate with name plate for AR22	Legend plate AR9P009-B Name plate AR9P010-B ①② (34 × 8mm)
	Legend plate AR9P011-B Name plate AR9P012-B ①② (34 × 13mm)
	Legend plate AR9P007-B Name plate AR9P008-B ①② (27 × 16mm)
	Name plate Code
	① ②
	ON 0 A
	OFF 0 B
	START 0 C
	STOP 0 D
	OFF-ON 2 A
	Dimensions, mm:



.AF96-190

Description	Type
Legend plate for AR30	AHX177-①②③④ This legend plate is for a 30.5mm dia. panel cutout hole.
	① Material and color
	Code Material Color
	S Brass Silver
	B Aluminum Black
	A Aluminum Aluminum
	② Size H: Standard S: Short size
	Legend Code
	③ ④
	Blank 0 0
	ON 0 A
	OFF 0 B
	START 0 C
	STOP 0 D
	OFF-ON 2 A
	Dimensions, mm:
	AHX177B AHX177A AHX177-BS AHX177-AS



Y-1545



AF89-466









AF87-49

Legend plate for AR30 emergency stop	AHX720-①② This aluminum legend plate is for a 30.5mm dia. panel cutout hole.
	Plate color: Yellow Letter color: Black
	Legend Code Letter height
	① ②
	Blank 0 0 -
	EMERGENCY STOP 5 A 7mm
	Dimensions, mm:
	Note: Engraving for making letters is not available.

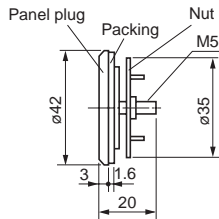

SK-598

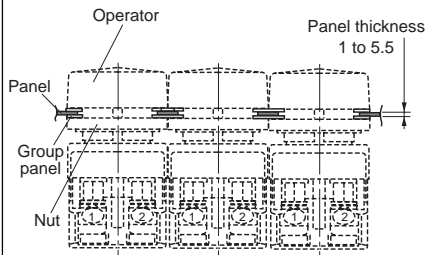
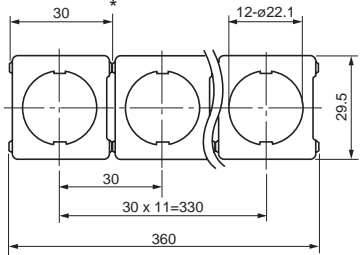
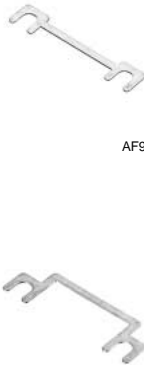

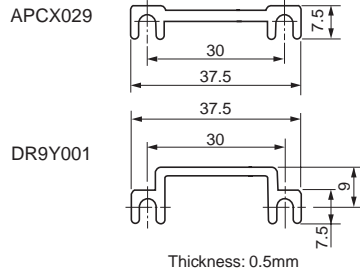
Description	Type
Panel plug for AR22 and DR22  <small>SI-1027</small>	Round: AHX725-B Black AHX725-H Gray Square: AHX726-B Black AHX726-H Gray Dimensions, mm: $\phi 29.5 \times 17$ (AHX725) $29.5 \text{ sq.} \times 17$ (AHX726) Use this plug to cover up unused panel cutout holes. For oil proof usage, use together with packing (AR9Y730) and a nut (AR9R744).
Panel plug for AR30 and DR30  <small>T-1993</small>	AHX004 Color: Silver (metal) This plug is used to cover up unused panel cutout hole. Dimensions, mm: 





Description	Type
Group panel for 22mm dia. type 	DR9Y004 These new 22mm dia. command switch/square types can be neatly aligned side by side on this group panel at a 30mm pitch to form a uniform panel face with no misalignment between mounted switches. Depending on the number of switches to be grouped (maximum 12), the panel can be divided (by cutting at the portion indicated by an asterisk (*)). Mounting, mm: (example showing a group of three)  Dimensions, mm:  <small>AF97-233</small>
Jumper  <small>AF95-153</small>  <small>AF95-27</small>	APCX029 (For pilot light without transformer) DR9Y001 (For pilot light with transformer) Use this jumper to connect terminals allocated in a 30mm pitch. Rated current is 3A Dimensions, mm:  Thickness: 0.5mm

Pushbuttons/Selectors/Pilot Lights





AR22/DR22 and AR30/DR30



Accessories

Description	Type																														
Lens for illuminated pushbutton switch and pilot lights 	<table border="1"> <thead> <tr> <th>Type</th> <th>Used with</th> </tr> </thead> <tbody> <tr> <td>AR9C011-□*¹</td> <td>AR22F0L, F5L, F0P, F5P</td> </tr> <tr> <td>AR9C012-□*¹</td> <td>AR22E0L, E5L, E0P, E5P AR22G1L, G2L, G4L, G6L, G7L, G9L DR22E3L, E3P AR30E0L, E5L, G2L, G3L, G4L, G7L, G8L, G9L DR30E3L</td> </tr> <tr> <td>AR9C013-□*¹</td> <td>AR22F0M, F5M</td> </tr> <tr> <td>AR9C014-□*¹</td> <td>AR22E0M, E5M DR22E3M, F5M</td> </tr> <tr> <td>AR9C015-□</td> <td>AR22M4L, M4P</td> </tr> <tr> <td>AR9C016-□</td> <td>AR22M0L, M5L</td> </tr> <tr> <td>DR9C001-□</td> <td>DR22D0L DR30D0L*²</td> </tr> <tr> <td>DR9C002-□</td> <td>DR22K0L DR30K0L*²</td> </tr> <tr> <td>DR9C120-C</td> <td>DR30M4M</td> </tr> <tr> <td>DR9C121-C</td> <td>DR30F4N</td> </tr> <tr> <td>DR9C122-C</td> <td>DR30F4M</td> </tr> <tr> <td>DR9C126-□*¹</td> <td>DR22F3M</td> </tr> <tr> <td>DR9C126-C</td> <td>DR22F4M</td> </tr> <tr> <td>DR9C127-□*¹</td> <td>DR22E3N</td> </tr> </tbody> </table>	Type	Used with	AR9C011 -□* ¹	AR22F0L, F5L, F0P, F5P	AR9C012 -□* ¹	AR22E0L, E5L, E0P, E5P AR22G1L, G2L, G4L, G6L, G7L, G9L DR22E3L, E3P AR30E0L, E5L, G2L, G3L, G4L, G7L, G8L, G9L DR30E3L	AR9C013 -□* ¹	AR22F0M, F5M	AR9C014 -□* ¹	AR22E0M, E5M DR22E3M, F5M	AR9C015 -□	AR22M4L, M4P	AR9C016 -□	AR22M0L, M5L	DR9C001 -□	DR22D0L DR30D0L* ²	DR9C002 -□	DR22K0L DR30K0L* ²	DR9C120-C	DR30M4M	DR9C121-C	DR30F4N	DR9C122-C	DR30F4M	DR9C126 -□* ¹	DR22F3M	DR9C126-C	DR22F4M	DR9C127 -□* ¹	DR22E3N
	Type	Used with																													
	AR9C011 -□* ¹	AR22F0L, F5L, F0P, F5P																													
	AR9C012 -□* ¹	AR22E0L, E5L, E0P, E5P AR22G1L, G2L, G4L, G6L, G7L, G9L DR22E3L, E3P AR30E0L, E5L, G2L, G3L, G4L, G7L, G8L, G9L DR30E3L																													
	AR9C013 -□* ¹	AR22F0M, F5M																													
	AR9C014 -□* ¹	AR22E0M, E5M DR22E3M, F5M																													
	AR9C015 -□	AR22M4L, M4P																													
	AR9C016 -□	AR22M0L, M5L																													
	DR9C001 -□	DR22D0L DR30D0L* ²																													
	DR9C002 -□	DR22K0L DR30K0L* ²																													
	DR9C120-C	DR30M4M																													
	DR9C121-C	DR30F4N																													
	DR9C122-C	DR30F4M																													
	DR9C126 -□* ¹	DR22F3M																													
	DR9C126-C	DR22F4M																													
	DR9C127 -□* ¹	DR22E3N																													
	<table border="1"> <thead> <tr> <th colspan="5">Replace the □ mark by the lens color code</th> </tr> <tr> <th>Color</th> <th>Green</th> <th>Red</th> <th>Clear</th> <th>Yellow</th> </tr> </thead> <tbody> <tr> <td>Code</td> <td>G</td> <td>R</td> <td>C</td> <td>Y</td> </tr> </tbody> </table>	Replace the □ mark by the lens color code					Color	Green	Red	Clear	Yellow	Code	G	R	C	Y															
	Replace the □ mark by the lens color code																														
	Color	Green	Red	Clear	Yellow																										
	Code	G	R	C	Y																										
<table border="1"> <thead> <tr> <th colspan="3">Replace the □ mark by the lens color code</th> </tr> <tr> <th>Color</th> <th>Orange</th> <th>Blue</th> <th>White</th> </tr> </thead> <tbody> <tr> <td>Code</td> <td>A</td> <td>S</td> <td>W</td> </tr> </tbody> </table>	Replace the □ mark by the lens color code			Color	Orange	Blue	White	Code	A	S	W																				
Replace the □ mark by the lens color code																															
Color	Orange	Blue	White																												
Code	A	S	W																												
Notes: * ¹ When the main unit code is "W" (white), use a lens of clear color. * ² Except for pilot lights with resistor																															
AF94-458																															
Button for pushbutton switch 	<table border="1"> <thead> <tr> <th>Type</th> <th>Used with</th> </tr> </thead> <tbody> <tr> <td>AR9C001-□</td> <td>AR22F0R, F5R, F0Y, F5Y, G2R, G7R AR30F0R, F5R, FVR AR22S1R, S2R, S3R, S6R AR30S1R, S2R, S3R, S6R</td> </tr> <tr> <td>AR9C003-□</td> <td>AR22E0R, E5R, G0R, G3R, G5R, G8R AR22E0Y, E5Y AR30E0R, E5R, G0R, G1R, G5R, G6R</td> </tr> <tr> <td>AR9C004-□</td> <td>AR22F0S, F5S</td> </tr> <tr> <td>AR9C005-□</td> <td>AR22E0S, E5S</td> </tr> <tr> <td>AR9C006-□</td> <td>AR22M4R, M9R, M4Y AR30M4R</td> </tr> <tr> <td>AR9C007-□</td> <td>AR22M0R, M5R AR30M0R, M3R, M5R, M8R</td> </tr> <tr> <td>AR9C024-□</td> <td>AR30B0R, B1R, B2R, B3R</td> </tr> <tr> <td>AR9C027-C</td> <td>AR22FAR, FBR, AR30FAR, FBR</td> </tr> <tr> <td>AR9C028-C</td> <td>AR22EAR, EBR, AR30EAR, EBR</td> </tr> <tr> <td>AR9C041-R</td> <td>AR30N0R</td> </tr> <tr> <td>AHX539</td> <td>Cap for AR30FVR</td> </tr> </tbody> </table>	Type	Used with	AR9C001 -□	AR22F0R, F5R, F0Y, F5Y, G2R, G7R AR30F0R, F5R, FVR AR22S1R, S2R, S3R, S6R AR30S1R, S2R, S3R, S6R	AR9C003 -□	AR22E0R, E5R, G0R, G3R, G5R, G8R AR22E0Y, E5Y AR30E0R, E5R, G0R, G1R, G5R, G6R	AR9C004 -□	AR22F0S, F5S	AR9C005 -□	AR22E0S, E5S	AR9C006 -□	AR22M4R, M9R, M4Y AR30M4R	AR9C007 -□	AR22M0R, M5R AR30M0R, M3R, M5R, M8R	AR9C024 -□	AR30B0R, B1R, B2R, B3R	AR9C027-C	AR22FAR, FBR, AR30FAR, FBR	AR9C028-C	AR22EAR, EBR, AR30EAR, EBR	AR9C041-R	AR30N0R	AHX539	Cap for AR30FVR						
	Type	Used with																													
	AR9C001 -□	AR22F0R, F5R, F0Y, F5Y, G2R, G7R AR30F0R, F5R, FVR AR22S1R, S2R, S3R, S6R AR30S1R, S2R, S3R, S6R																													
	AR9C003 -□	AR22E0R, E5R, G0R, G3R, G5R, G8R AR22E0Y, E5Y AR30E0R, E5R, G0R, G1R, G5R, G6R																													
	AR9C004 -□	AR22F0S, F5S																													
	AR9C005 -□	AR22E0S, E5S																													
	AR9C006 -□	AR22M4R, M9R, M4Y AR30M4R																													
	AR9C007 -□	AR22M0R, M5R AR30M0R, M3R, M5R, M8R																													
	AR9C024 -□	AR30B0R, B1R, B2R, B3R																													
	AR9C027-C	AR22FAR, FBR, AR30FAR, FBR																													
AR9C028-C	AR22EAR, EBR, AR30EAR, EBR																														
AR9C041-R	AR30N0R																														
AHX539	Cap for AR30FVR																														
<table border="1"> <thead> <tr> <th colspan="5">Replace the □ mark by the button color code</th> </tr> <tr> <th>Color</th> <th>Green</th> <th>Red</th> <th>Black</th> <th>White</th> </tr> </thead> <tbody> <tr> <td>Code</td> <td>G</td> <td>R</td> <td>B</td> <td>W</td> </tr> </tbody> </table>	Replace the □ mark by the button color code					Color	Green	Red	Black	White	Code	G	R	B	W																
Replace the □ mark by the button color code																															
Color	Green	Red	Black	White																											
Code	G	R	B	W																											
<table border="1"> <thead> <tr> <th colspan="3">Replace the □ mark by the button color code</th> </tr> <tr> <th>Color</th> <th>Yellow</th> <th>Orange</th> <th>Blue</th> </tr> </thead> <tbody> <tr> <td>Code</td> <td>Y</td> <td>A</td> <td>S</td> </tr> </tbody> </table>	Replace the □ mark by the button color code			Color	Yellow	Orange	Blue	Code	Y	A	S																				
Replace the □ mark by the button color code																															
Color	Yellow	Orange	Blue																												
Code	Y	A	S																												
KK02-101A																															
KK02-102A																															
KK02-103A																															

Description	Type																				
Center button (For V type) 	<table border="1"> <thead> <tr> <th>Type</th> <th>Used with</th> </tr> </thead> <tbody> <tr> <td>AR9C020-R</td> <td>AR22V0R, V2R, VSR AR30V0R, V2R</td> </tr> <tr> <td>AR9C020-□</td> <td>AR22V5R, AR30V5R</td> </tr> <tr> <td>AR9C018-R</td> <td>AR22V0L, V2L, VDL, VAL, VSL AR30V0L, V2L</td> </tr> <tr> <td>AR9C018-□</td> <td>AR22V5L*, AR30V5L*</td> </tr> </tbody> </table>	Type	Used with	AR9C020-R	AR22V0R, V2R, VSR AR30V0R, V2R	AR9C020 -□	AR22V5R, AR30V5R	AR9C018-R	AR22V0L, V2L, VDL, VAL, VSL AR30V0L, V2L	AR9C018 -□	AR22V5L*, AR30V5L*										
	Type	Used with																			
AR9C020-R	AR22V0R, V2R, VSR AR30V0R, V2R																				
AR9C020 -□	AR22V5R, AR30V5R																				
AR9C018-R	AR22V0L, V2L, VDL, VAL, VSL AR30V0L, V2L																				
AR9C018 -□	AR22V5L*, AR30V5L*																				
<table border="1"> <thead> <tr> <th colspan="4">Replace the □ mark by the button color code</th> </tr> <tr> <th>Color</th> <th>Red</th> <th>Black</th> <th>Yellow</th> </tr> </thead> <tbody> <tr> <td>Code</td> <td>R</td> <td>B</td> <td>Y</td> </tr> </tbody> </table>	Replace the □ mark by the button color code				Color	Red	Black	Yellow	Code	R	B	Y									
Replace the □ mark by the button color code																					
Color	Red	Black	Yellow																		
Code	R	B	Y																		
Note: * V5L: Red and yellow only																					
AF95-32																					
Push-lock, turn-reset button (V and Q types) 	<table border="1"> <thead> <tr> <th>Type</th> <th>Used with</th> </tr> </thead> <tbody> <tr> <td>AR9C008-R</td> <td>AR22V4R</td> </tr> <tr> <td>AR9C010-R</td> <td>AR22Q2R, AR30Q2R</td> </tr> <tr> <td>AR9C017-R</td> <td>AR22V2R, V2L, AR30V2R, V2L</td> </tr> <tr> <td>AR9C019-R</td> <td>AR22VAL</td> </tr> <tr> <td>AR9C021-R</td> <td>AR22V0R, V0L, AR30V0R, V0L</td> </tr> <tr> <td>AR9C021-□</td> <td>AR22V5R, V5L*, AR30V5R, V5L*</td> </tr> <tr> <td>AR9C026-R</td> <td>AR22VDL</td> </tr> <tr> <td>AR9C029-R</td> <td>AR30V1R</td> </tr> <tr> <td>AR9C040-R</td> <td>AR22VSR, VSL</td> </tr> </tbody> </table>	Type	Used with	AR9C008-R	AR22V4R	AR9C010-R	AR22Q2R, AR30Q2R	AR9C017-R	AR22V2R, V2L, AR30V2R, V2L	AR9C019-R	AR22VAL	AR9C021-R	AR22V0R, V0L, AR30V0R, V0L	AR9C021 -□	AR22V5R, V5L*, AR30V5R, V5L*	AR9C026-R	AR22VDL	AR9C029-R	AR30V1R	AR9C040-R	AR22VSR, VSL
	Type	Used with																			
	AR9C008-R	AR22V4R																			
	AR9C010-R	AR22Q2R, AR30Q2R																			
	AR9C017-R	AR22V2R, V2L, AR30V2R, V2L																			
	AR9C019-R	AR22VAL																			
	AR9C021-R	AR22V0R, V0L, AR30V0R, V0L																			
	AR9C021 -□	AR22V5R, V5L*, AR30V5R, V5L*																			
	AR9C026-R	AR22VDL																			
	AR9C029-R	AR30V1R																			
AR9C040-R	AR22VSR, VSL																				
<table border="1"> <thead> <tr> <th colspan="4">Replace the □ mark by the button color code</th> </tr> <tr> <th>Color</th> <th>Red</th> <th>Black</th> <th>Yellow</th> </tr> </thead> <tbody> <tr> <td>Code</td> <td>R</td> <td>B</td> <td>Y</td> </tr> </tbody> </table>	Replace the □ mark by the button color code				Color	Red	Black	Yellow	Code	R	B	Y									
Replace the □ mark by the button color code																					
Color	Red	Black	Yellow																		
Code	R	B	Y																		
Note: * V5L: Red and yellow only																					
AF95-31																					
KK02-104A																					
Knob 	<table border="1"> <thead> <tr> <th>Type</th> <th>Used with</th> </tr> </thead> <tbody> <tr> <td>AR9M006-□</td> <td>AR22PR, PCR, PY, PCY AR30PR, PCR</td> </tr> </tbody> </table>	Type	Used with	AR9M006 -□	AR22PR, PCR, PY, PCY AR30PR, PCR																
	Type	Used with																			
AR9M006 -□	AR22PR, PCR, PY, PCY AR30PR, PCR																				
<table border="1"> <thead> <tr> <th colspan="4">Replace the □ mark by the knob color code</th> </tr> <tr> <th>Color</th> <th>Black</th> <th>Green</th> <th>Red</th> </tr> </thead> <tbody> <tr> <td>Code</td> <td>B</td> <td>G</td> <td>R</td> </tr> </tbody> </table>	Replace the □ mark by the knob color code				Color	Black	Green	Red	Code	B	G	R									
Replace the □ mark by the knob color code																					
Color	Black	Green	Red																		
Code	B	G	R																		
AF95-43																					
Lever 	<table border="1"> <thead> <tr> <th>Type</th> <th>Used with</th> </tr> </thead> <tbody> <tr> <td>AR9M007-□</td> <td>AR22WR, WCR, WY, WCY AR30WR, WCR</td> </tr> </tbody> </table>	Type	Used with	AR9M007 -□	AR22WR, WCR, WY, WCY AR30WR, WCR																
	Type	Used with																			
AR9M007 -□	AR22WR, WCR, WY, WCY AR30WR, WCR																				
<table border="1"> <thead> <tr> <th colspan="4">Replace the □ mark by the lever color code</th> </tr> <tr> <th>Color</th> <th>Black</th> <th>Green</th> <th>Red</th> </tr> </thead> <tbody> <tr> <td>Code</td> <td>B</td> <td>G</td> <td>R</td> </tr> </tbody> </table>	Replace the □ mark by the lever color code				Color	Black	Green	Red	Code	B	G	R									
Replace the □ mark by the lever color code																					
Color	Black	Green	Red																		
Code	B	G	R																		
AF95-42																					
Cylindrical knob 	<table border="1"> <thead> <tr> <th>Type</th> <th>Used with</th> </tr> </thead> <tbody> <tr> <td>AR9M008-□</td> <td>AR22RR, RCR, RY, RCY</td> </tr> </tbody> </table>	Type	Used with	AR9M008 -□	AR22RR, RCR, RY, RCY																
	Type	Used with																			
AR9M008 -□	AR22RR, RCR, RY, RCY																				
<table border="1"> <thead> <tr> <th colspan="4">Replace the □ mark by the knob color code</th> </tr> <tr> <th>Color</th> <th>Black</th> <th>Green</th> <th>Red</th> </tr> </thead> <tbody> <tr> <td>Code</td> <td>B</td> <td>G</td> <td>R</td> </tr> </tbody> </table>	Replace the □ mark by the knob color code				Color	Black	Green	Red	Code	B	G	R									
Replace the □ mark by the knob color code																					
Color	Black	Green	Red																		
Code	B	G	R																		
AF95-44																					

Pushbuttons/Selectors/Pilot Lights AR22/DR22 and AR30/DR30 Accessories





<p>Description</p> <p>Knob (for illuminated selector switch)</p>  <p style="text-align: right; font-size: small;">AF94-465</p>	<p>Type</p> <table style="width: 100%; border-collapse: collapse;"> <tr> <td style="width: 30%;">Type</td> <td>Used with</td> </tr> <tr> <td>AR9M005-□</td> <td>AR22PL, PP AR30PL</td> </tr> </table> <p>Replace the □ mark by the knob color code</p> <table style="width: 100%; border-collapse: collapse;"> <tr> <td style="width: 20%;">Color</td> <td>Green</td> <td>Red</td> <td>White</td> </tr> <tr> <td>Code</td> <td>G</td> <td>R</td> <td>W</td> </tr> </table> <hr/> <table style="width: 100%; border-collapse: collapse;"> <tr> <td style="width: 20%;">Color</td> <td>Yellow</td> <td>Orange</td> <td>Blue</td> </tr> <tr> <td>Code</td> <td>Y</td> <td>A</td> <td>S</td> </tr> </table>	Type	Used with	AR9M005 -□	AR22PL, PP AR30PL	Color	Green	Red	White	Code	G	R	W	Color	Yellow	Orange	Blue	Code	Y	A	S																	
Type	Used with																																					
AR9M005 -□	AR22PL, PP AR30PL																																					
Color	Green	Red	White																																			
Code	G	R	W																																			
Color	Yellow	Orange	Blue																																			
Code	Y	A	S																																			
<p>Key</p>  <p style="text-align: right; font-size: small;">KKD09-012</p>	<p>Type</p> <table style="width: 100%; border-collapse: collapse;"> <tr> <td style="width: 30%;">Type</td> <td>Used with</td> </tr> <tr> <td>AR9C022-□</td> <td>AR22JR, JCR, AR30JR, JCR,</td> </tr> <tr> <td>AR9C025-□</td> <td>AR22JAR, AR30JAR</td> </tr> </table> <p>Replace the □ mark by the key type code. Code: A, B, C, D, E or F, 6 types.</p>	Type	Used with	AR9C022 -□	AR22JR, JCR, AR30JR, JCR,	AR9C025 -□	AR22JAR, AR30JAR																															
Type	Used with																																					
AR9C022 -□	AR22JR, JCR, AR30JR, JCR,																																					
AR9C025 -□	AR22JAR, AR30JAR																																					
<p>Legend plate (for F type with round bezel)</p>  <p style="text-align: right; font-size: small;">AF94-459</p>	<p>AR9P001-W</p> <p>This part is made of acrylic resin. Use paint or thinner compatible with resin.</p> <p>Dimensions, mm: ø17.8 x 0.9</p>																																					
<p>Legend plate (for E type with round bezel)</p>  <p style="text-align: right; font-size: small;">AF94-459</p>	<p>AR9P002-W</p> <p>This part is made of acrylic resin. Use paint or thinner compatible with resin.</p> <p>Dimensions, mm: ø19.7 x 4.2</p>																																					
<p>Symbol mark plate</p>  <p style="text-align: right; font-size: small;">AF98-197</p>	<table style="width: 100%; border-collapse: collapse;"> <tr> <td style="width: 30%;">Type</td> <td>Used with</td> </tr> <tr> <td>AR9P019-□ □ ■</td> <td>AR22FAR, FBR, AR30FAR, FBR</td> </tr> <tr> <td>AR9P020-□ □ ■</td> <td>AR22EAR, EBR, AR30EAR, EBR</td> </tr> </table> <p>□ □ ■ :</p> <table style="width: 100%; border-collapse: collapse; font-size: x-small;"> <tr> <td style="width: 10%;">Symbol</td> <td style="width: 10%;">○</td> <td style="width: 10%;"> </td> <td style="width: 10%;">⊕</td> <td style="width: 10%;">○</td> <td style="width: 10%;"> </td> <td style="width: 10%;">⊕</td> </tr> <tr> <td>Plate</td> <td>W</td> <td>B</td> <td>W</td> <td>B</td> <td>W</td> <td>B</td> <td>Clear</td> </tr> <tr> <td>Symbol</td> <td>Red</td> <td>Green</td> <td>Green</td> <td>Black</td> <td></td> <td></td> <td></td> </tr> <tr> <td>Code</td> <td>01</td> <td>02</td> <td>03</td> <td>04</td> <td>11</td> <td>12</td> <td>02B 04B 12B</td> </tr> </table> <p>W: White, B: black</p>	Type	Used with	AR9P019 -□ □ ■	AR22FAR, FBR, AR30FAR, FBR	AR9P020 -□ □ ■	AR22EAR, EBR, AR30EAR, EBR	Symbol	○		⊕	○		⊕	Plate	W	B	W	B	W	B	Clear	Symbol	Red	Green	Green	Black				Code	01	02	03	04	11	12	02B 04B 12B
Type	Used with																																					
AR9P019 -□ □ ■	AR22FAR, FBR, AR30FAR, FBR																																					
AR9P020 -□ □ ■	AR22EAR, EBR, AR30EAR, EBR																																					
Symbol	○		⊕	○		⊕																																
Plate	W	B	W	B	W	B	Clear																															
Symbol	Red	Green	Green	Black																																		
Code	01	02	03	04	11	12	02B 04B 12B																															

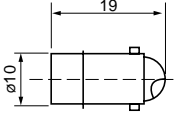

<p>Description</p> <p>Legend plate and color plate (for F type with square bezel)</p>  <p style="text-align: right; font-size: small;">AF94-460</p>	<p>• Legend plate</p> <table style="width: 100%; border-collapse: collapse;"> <tr> <td style="width: 30%;">Type</td> <td>Used with</td> </tr> <tr> <td>DR9P241-W</td> <td>AR22F0M, F5M DR22F3M, F4M</td> </tr> <tr> <td>DR9P242-WP</td> <td>DR30M4M</td> </tr> <tr> <td>DR9P242-W</td> <td>DR30M4M, LED(W)</td> </tr> <tr> <td>DR9P243-WP</td> <td>DR30F4N</td> </tr> <tr> <td>DR9P243-W</td> <td>DR30F4N, LED(W)</td> </tr> <tr> <td>DR9P244-WP</td> <td>DR30F4M</td> </tr> <tr> <td>DR9P244-W</td> <td>DR30F4M, LED(W)</td> </tr> </table> <p>Types DR9P242, 243 and 244-W are LED illuminated, and used exclusively with operators having a "W" in the type number.</p> <p>• color plate</p> <table style="width: 100%; border-collapse: collapse;"> <tr> <td style="width: 30%;">Type</td> <td>Used with</td> </tr> <tr> <td>DR9P241-□</td> <td>DR22F3M, F4M</td> </tr> <tr> <td>DR9P242-□</td> <td>DR30M4M</td> </tr> <tr> <td>DR9P243-□</td> <td>DR30F4N</td> </tr> <tr> <td>DR9P244-□</td> <td>DR30F4M</td> </tr> </table> <p>Replace the □ mark by the color code</p> <table style="width: 100%; border-collapse: collapse;"> <tr> <td style="width: 20%;">Color</td> <td>Green</td> <td>Red</td> <td>White</td> </tr> <tr> <td>Code</td> <td>G</td> <td>R</td> <td>W</td> </tr> </table> <hr/> <table style="width: 100%; border-collapse: collapse;"> <tr> <td style="width: 20%;">Color</td> <td>Yellow</td> <td>Orange</td> <td>Blue</td> </tr> <tr> <td>Code</td> <td>Y</td> <td>A</td> <td>S</td> </tr> </table> <p>This part is made of acrylic resin. Use paint or thinner compatible with resin.</p> <p>Dimensions, mm: DR9P241: 20.8 sq. x 0.8 DR9P242: 33.4 sq. x 1 DR9P243: 33.4 x 27.4 x 1 DR9P244: 27.4 sq. x 1</p>	Type	Used with	DR9P241-W	AR22F0M, F5M DR22F3M, F4M	DR9P242-WP	DR30M4M	DR9P242-W	DR30M4M, LED(W)	DR9P243-WP	DR30F4N	DR9P243-W	DR30F4N, LED(W)	DR9P244-WP	DR30F4M	DR9P244-W	DR30F4M, LED(W)	Type	Used with	DR9P241 -□	DR22F3M, F4M	DR9P242 -□	DR30M4M	DR9P243 -□	DR30F4N	DR9P244 -□	DR30F4M	Color	Green	Red	White	Code	G	R	W	Color	Yellow	Orange	Blue	Code	Y	A	S
Type	Used with																																										
DR9P241-W	AR22F0M, F5M DR22F3M, F4M																																										
DR9P242-WP	DR30M4M																																										
DR9P242-W	DR30M4M, LED(W)																																										
DR9P243-WP	DR30F4N																																										
DR9P243-W	DR30F4N, LED(W)																																										
DR9P244-WP	DR30F4M																																										
DR9P244-W	DR30F4M, LED(W)																																										
Type	Used with																																										
DR9P241 -□	DR22F3M, F4M																																										
DR9P242 -□	DR30M4M																																										
DR9P243 -□	DR30F4N																																										
DR9P244 -□	DR30F4M																																										
Color	Green	Red	White																																								
Code	G	R	W																																								
Color	Yellow	Orange	Blue																																								
Code	Y	A	S																																								
<p>Legend plate (for E type with square bezel)</p>  <p style="text-align: right; font-size: small;">AF94-460</p>	<table style="width: 100%; border-collapse: collapse;"> <tr> <td style="width: 30%;">Type</td> <td>Used with</td> </tr> <tr> <td>AR9P003-W</td> <td>AR22E0M, E5M DR22F5M, E3M</td> </tr> <tr> <td>DR9P001-W</td> <td>DR22E3N</td> </tr> </table> <p>This part is made of acrylic resin. Use paint or thinner compatible with resin.</p> <p>Dimensions, mm: AR9P003-W: 20 sq. x 4.8 DR9P001-W: 19.7 x 26.7 x 4.5</p>	Type	Used with	AR9P003-W	AR22E0M, E5M DR22F5M, E3M	DR9P001-W	DR22E3N																																				
Type	Used with																																										
AR9P003-W	AR22E0M, E5M DR22F5M, E3M																																										
DR9P001-W	DR22E3N																																										
<p>Legend sheet</p>  <p style="text-align: right; font-size: small;">AF95-34</p>	<p>AHX727</p> <p>Affix this seal to the DR9P241-□/AR9P003 legend plate for marking or labeling.</p> <p>Dimensions, mm: 20 sq. x 0.025</p>																																										

Pushbuttons/Selectors/Pilot Lights

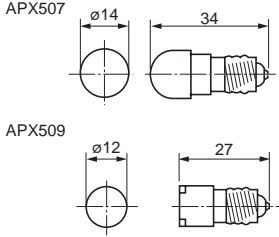
AR22/DR22 and AR30/DR30

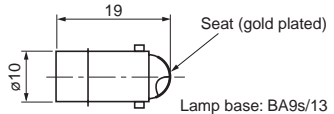



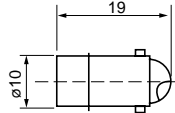

Accessories



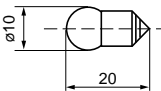

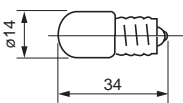
Description	Type
LED lamp  KKD06-208	Type Lamp voltage
	APX510-6 □ 6V AC
	APX510-D6 □ 6V DC
	APX510-12 □ 12V AC/DC
	APX510-15 □ 15V AC/DC
	APX510-24 □ 24V AC/DC
	Replace the □ mark by the luminous color code
	Luminous color Yellow Red Green
	Code Y R G
	Lens color Y R G
Luminous color Amber Orange Blue	
Code A O S	
Lens color A W, A* S	
* Orange is available only for the DR22F4M pilot light.	
Dimensions, mm: 	Lamp base: BA9s/13
LED lamp (for DR30 with resistor)	Type Lamp voltage
 KK02-110A	APX507-24 □ 24V AC/DC
	APX509-24O
 KK02-111A	Note: The symbol in the box indicates the color of light emitted. (See note APX510.) When the code is "W" (white), use an LED lamp ((APX.509-24O)
	Dimensions, mm:  Lamp base: E12/15
LED lamp (for AR22VGF type)	Type Lamp voltage
 KK02-109A	AR9L002-ER 24V AC/DC
	Luminous color: Red
Dimensions, mm: 	Lamp base: BA9s/13
Do not use the LED lamp for other types.	

Description	Type
Neon lamp (for AR22VGF type)	Type Lamp voltage
 KK03-038	AR9N001-HA 110V AC
	AR9N001-KA 120V AC
	AR9N001-MA 220V AC
	AR9N001-PA 240V AC
	Luminous color: Orange
Dimensions, mm:	
Do not use the LED lamp for other types.	
LED lamp for DR30 (square type)	Type Lamp voltage
 KKD06-208	DN6Q005-6 □ 6V DC
	DN6Q005-2 □ 12V AC
	DN6Q005-B □ 12V AC/DC
	DN6Q005-E □ 24V AC/DC
	Replace the □ mark by the luminous color code
Luminous color Yellow Red Green	
Code Y R G	
Lens color Y R G	
Luminous color Amber Orange	
Code Y W	
Lens color Y W	
Dimensions, mm: 	Lamp base: BA9s/13
Do not use the LED lamp for other types.	

Pushbuttons/Selectors/Pilot Lights AR22/DR22 and AR30/DR30 Accessories

04

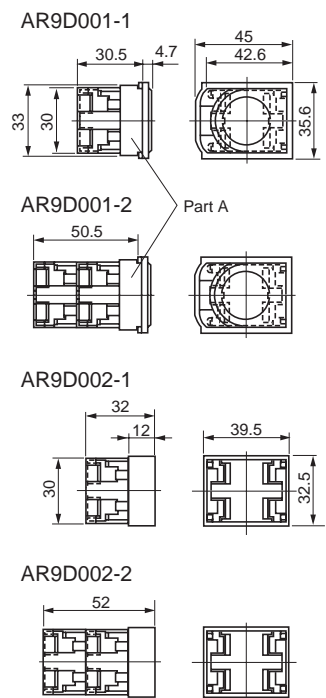



Description	Type		
 AF89-427	Type	Lamp voltage	Rated voltage, consumption
	AHX135	5.5V AC/DC	6.3V AC/DC, 1W
	AHX279	15V AC/DC	18V AC/DC, 1W
	AHX144	20V AC/DC	24V AC/DC, 1W
	AHX129	24V AC/DC	30V AC/DC, 1W
Dimensions, mm:			
 Lamp base: BA9s/13			
 KK02-115A	Type	Lamp voltage	Rated voltage, consumption
	AHX130	15V AC/DC	18V AC/DC, 2W
Dimensions, mm:			
 Lamp base: E12/15			
 AF94-455	AR9B290	Standard	Overlap
	AR9B290-S	Overlap	
Color: Blue Dimensions, mm: 19.3 x 29 x 27 Note: Terminal cover is not supplied with this.			
 AF94-455	AR9B291	Standard	Overlap
	AR9B291-S	Overlap	
Color: Red Dimensions, mm: 19.3 x 29 x 27 Note: Terminal cover is not supplied with this.			
 AF94-456	AR9B292		
	Color: Black Dimensions, mm: 19.3 x 29 x 27 Note: Terminal cover is not supplied with this.		

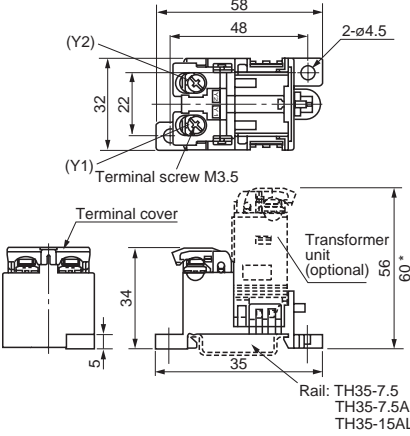

Description	Type			
 KK02-117A  KK02-118A	Type	Used with *		
	AR9D001-1	AR22, 1-step contact		
	AR9D001-2	AR22, 2-step contact		
	AR9D002-1	AR30, 1-step contact		
	AR9D002-2	AR30, 2-step contact		
	<ul style="list-style-type: none"> The contact is covered with a silicon rubber cover to keep out foreign matter such as dust, etc. Section A of the AR9D001 is separate. * See page 04/122, "AR22 □ Z8, AR30 □ Z8"			
	Dimensions, mm:			
				
	Transformer unit			
	 AF94-457  AF95-33	Type	Primary voltage	Used with
AR9T511-H		100-110V AC	Standard type (except buzzers)	
AR9T511-L		115-127V AC		
AR9T511-M		200-220V AC		
AR9T511-Q		230-254V AC		
AR9T511-S		350-380V AC		
AR9T511-T		400-440V AC		
AR9T511-V		480V AC		
AR9T511-W		500-550V AC		
AR9T557-H		100-110V AC	DR30F4N, F4M, M4M	
AR9T557-L		115-127V AC		
AR9T557-M		200-220V AC		
AR9T557-Q		230-254V AC		
AR9T557-S		350-380V AC		
AR9T557-T		400-440V AC		
AR9T557-V		480V AC		
AR9T557-W		500-550V AC		
Dimensions, mm:				
		Up to 220 V	22.4 x 30 x 45	
		Over 220 V	25.3 x 29 x 48	
Note: With terminal cover				

Pushbuttons/Selectors/Pilot Lights





AR22/DR22 and AR30/DR30



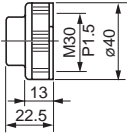
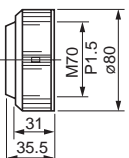

Accessories

Description	Type		
Base unit for transformer separate mounting	AR9T003 Use this base in combination with a transformer unit. This base unit can be mounted using screws or rails.		
 KK02-118A	Dimensions, mm  * Except for the types 110V AC, 127V AC and 220V AC.		
Resistor Voltage stabilizer Device for LED lamp flickering	Resistor: AR9T519-H (110V DC) Fit this resistor when using LED of 24V DC rating with 110V DC power.		
 AF95-33	Voltage stabilizer: AR9T001-E This unit allows an LED lamp of 24V DC rating to be used in a circuit with voltage from 27V to 35V (AC or DC). Flickering device: 6V AC: AR9T002-A 6V DC: AR9T002-6 12 to 24V AC: AR9T002-G * 12 to 24V DC: AR9T002-E * * Used in combination with 12V, 15V, or 24V rated LED lamp. Note: With terminal cover		
Nut	Type	Used with	Dimensions, mm
 AF94-462	AR9R744 DR9R001	AR22, DR22* DR30F4M DR30F4N DR30M4M	$\varnothing 29.7 \times 4$ $\varnothing 33.8 \times 5$
 KK2-119A	* Except AR22VG□, Joy stick selectors, buzzers and numerical indicators		

Description	Type													
Nut for 30mm dia. types (Resin types are black, metallic types are silver.)	AR9R001 : Resin types are black (standard) AHX088 : Metallic types are silver													
 KK2-120A KK2-121A KK2-122A KK2-123A	Used with: AR30F0R, F5R, FAR, FBR, E0R, E5R, EAR, EBR, E0L, E5L, Q7L DR30D0L, E3L, K0L AR9R002 : Resin types are black (standard) AHX093 : Metallic types are silver Used with: AR30M0R, M5R, M4R, G0R, G5R, N0R, S□R, V□R, Q2R, V□L, PR, PCR, WR, WCR, JR, JCR, JAR, PL, A□N, A□H													
Water-tight cap for 22mm dia. types	AR9D797 -□													
 KK2-124A	This rubber cap protects the operator and switch mechanism against dust and water. Use this cap in a dusty or moist environment. Used with: AR22E0L, E5L AR22E0R, E5R Replace the □ mark by the luminous color code. <table border="1" data-bbox="1031 1406 1279 1585"> <thead> <tr> <th>Code</th> <th>Color</th> </tr> </thead> <tbody> <tr> <td>G</td> <td>Green</td> </tr> <tr> <td>R</td> <td>Red</td> </tr> <tr> <td>B</td> <td>Black</td> </tr> <tr> <td>Y</td> <td>Yellow</td> </tr> <tr> <td>Blank</td> <td>Clear (standard)</td> </tr> </tbody> </table>		Code	Color	G	Green	R	Red	B	Black	Y	Yellow	Blank	Clear (standard)
Code	Color													
G	Green													
R	Red													
B	Black													
Y	Yellow													
Blank	Clear (standard)													
 Y-1559	AHX052 This rubber cap protects the operator and switch mechanism against dust and water. Use this cap in a dusty or moist environment. The only color available is transparent. Used with: AR30E□R, E□L Dimensions, mm: $\varnothing 36 \times 22.5$													

Pushbuttons/Selectors/Pilot Lights AR22/DR22 and AR30/DR30 Accessories

Description	Type																																																																
Dust-proof cap for 30mm dia. types	<table border="1"> <thead> <tr> <th>Type</th> <th>Color</th> <th>Used with</th> <th>Spec.</th> </tr> </thead> <tbody> <tr> <td>AHX032</td> <td>Red</td> <td>AR30E0R</td> <td>Oil-proof</td> </tr> <tr> <td>AHX033</td> <td>Green</td> <td></td> <td></td> </tr> <tr> <td>AHX034</td> <td>Black</td> <td></td> <td></td> </tr> <tr> <td>AHX041</td> <td>Red</td> <td>AR30F0R</td> <td>Oil-proof</td> </tr> <tr> <td>AHX042</td> <td>Green</td> <td></td> <td></td> </tr> <tr> <td>AHX043</td> <td>Black</td> <td></td> <td></td> </tr> <tr> <td>AHX157-R</td> <td>Red</td> <td>AR30B2R,</td> <td>Oil-proof</td> </tr> <tr> <td>AHX157-G</td> <td>Green</td> <td>B3R</td> <td></td> </tr> <tr> <td>AHX157-B</td> <td>Black</td> <td></td> <td></td> </tr> <tr> <td>AHX113-R</td> <td>Red</td> <td>AR30E0R</td> <td>Weather resistance</td> </tr> <tr> <td>AHX113-G</td> <td>Green</td> <td></td> <td></td> </tr> <tr> <td>AHX113-B</td> <td>Black</td> <td></td> <td></td> </tr> <tr> <td>AHX111-R</td> <td>Red</td> <td>AR30F0R</td> <td>Weather resistance</td> </tr> <tr> <td>AHX111-G</td> <td>Green</td> <td></td> <td></td> </tr> <tr> <td>AHX111-B</td> <td>Black</td> <td></td> <td></td> </tr> </tbody> </table>	Type	Color	Used with	Spec.	AHX032	Red	AR30E0R	Oil-proof	AHX033	Green			AHX034	Black			AHX041	Red	AR30F0R	Oil-proof	AHX042	Green			AHX043	Black			AHX157-R	Red	AR30B2R,	Oil-proof	AHX157-G	Green	B3R		AHX157-B	Black			AHX113-R	Red	AR30E0R	Weather resistance	AHX113-G	Green			AHX113-B	Black			AHX111-R	Red	AR30F0R	Weather resistance	AHX111-G	Green			AHX111-B	Black		
	Type	Color	Used with	Spec.																																																													
	AHX032	Red	AR30E0R	Oil-proof																																																													
	AHX033	Green																																																															
	AHX034	Black																																																															
	AHX041	Red	AR30F0R	Oil-proof																																																													
	AHX042	Green																																																															
	AHX043	Black																																																															
	AHX157-R	Red	AR30B2R,	Oil-proof																																																													
	AHX157-G	Green	B3R																																																														
	AHX157-B	Black																																																															
	AHX113-R	Red	AR30E0R	Weather resistance																																																													
	AHX113-G	Green																																																															
	AHX113-B	Black																																																															
	AHX111-R	Red	AR30F0R	Weather resistance																																																													
AHX111-G	Green																																																																
AHX111-B	Black																																																																
	SC-993																																																																
	AF89-772																																																																
<p>Dimensions, mm:</p> <p>AHX032 to 034, 041 to 043 AHX111, 113</p>  <p>AHX157</p>  <p>Used for sealing the operator from foreign debris such as dust, oil (oil-proof), and water (weather resistance) in environments where the unit is in contact with such elements.</p>																																																																	
Packing	<p>AR9Y730: AR22 and DR22 (Rubber)</p> <p>Note: Except for joystick selector switches, buzzers</p> <p>AHX282: AR30 and DR30 (Resin-standerd)</p> <p>Note: Except for DR30F4M, F4N, M4M, numerical indicators</p> <p>AHX149: AR30 and DR30 (Rubber)</p> <p>Note: Except for DR30F4M, F4N, M4M, numerical indicators</p>																																																																
	AF94-462																																																																
	KK2-125A																																																																

Description	Type												
Terminal cover	<table border="1"> <thead> <tr> <th>Type</th> <th>Used with</th> <th>Dimensions, mm</th> </tr> </thead> <tbody> <tr> <td>AR9Y305</td> <td>Contact unit Lamp terminal Transformer unit *1</td> <td>18.4 x 29 x 8.4</td> </tr> <tr> <td>DR9Y320</td> <td>Pilot lights *2 (without transformer)</td> <td>ø22 x 5.8</td> </tr> <tr> <td>DR9Y321</td> <td>DR30F4M, F4N, M4M (without transformer)</td> <td>34 sq. x 8.7</td> </tr> </tbody> </table>	Type	Used with	Dimensions, mm	AR9Y305	Contact unit Lamp terminal Transformer unit *1	18.4 x 29 x 8.4	DR9Y320	Pilot lights *2 (without transformer)	ø22 x 5.8	DR9Y321	DR30F4M, F4N, M4M (without transformer)	34 sq. x 8.7
	Type	Used with	Dimensions, mm										
AR9Y305	Contact unit Lamp terminal Transformer unit *1	18.4 x 29 x 8.4											
DR9Y320	Pilot lights *2 (without transformer)	ø22 x 5.8											
DR9Y321	DR30F4M, F4N, M4M (without transformer)	34 sq. x 8.7											
	AF94-466												
	KK2-126A												
Terminal cover	<table border="1"> <thead> <tr> <th>Type</th> <th>Used with</th> <th>Dimensions, mm</th> </tr> </thead> <tbody> <tr> <td>AHX305</td> <td>Buzzers (without transformer)</td> <td>23.5 x 27.5 x 16</td> </tr> <tr> <td>AHX426</td> <td>DR30D1L (without transformer)</td> <td>27.5 x 31 x 8</td> </tr> <tr> <td>AHX376</td> <td>DR30D1L (with transformer) Buzzers (B0 type)</td> <td>13 x 29 x 6.5</td> </tr> </tbody> </table> <p>With transformer * With short-body transformer With resistor unit</p> <p>* 230V and over</p> <p>The terminal cover is provided as standard with the applicable types listed above.</p>	Type	Used with	Dimensions, mm	AHX305	Buzzers (without transformer)	23.5 x 27.5 x 16	AHX426	DR30D1L (without transformer)	27.5 x 31 x 8	AHX376	DR30D1L (with transformer) Buzzers (B0 type)	13 x 29 x 6.5
Type	Used with	Dimensions, mm											
AHX305	Buzzers (without transformer)	23.5 x 27.5 x 16											
AHX426	DR30D1L (without transformer)	27.5 x 31 x 8											
AHX376	DR30D1L (with transformer) Buzzers (B0 type)	13 x 29 x 6.5											
	AHX305 SG-842												
	AHX426 AF92-339												
	AHX376 SG-5												

*1 Applicable up to 220V.
*2 DR22D0L, E3L, K0L, F□M, E3M, E3N, E3P, DR30D0L, E3L, K0L

The terminal cover is provided as standard with the applicable types listed above. (Except for joy stick selector switches, numerical indicators, pilot lights with resistors, contact block alone and lamp terminal alone)

Pushbuttons/Selectors/Pilot Lights/Buzzers

AR22 Special products



Semi standard compliant guarding

■ Features

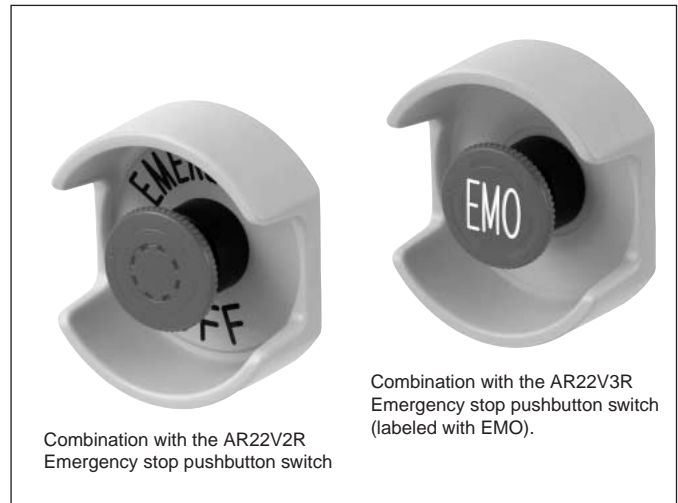
- Combine a guard ring with a Fuji electric emergency stop pushbutton switches to comply with SEMI (SEMI-S2, SEMATECH Application Guide for SEMI S2-93).
- EMERGENCY OFF legend plates are available.
- Emergency stop pushbutton switches labeled with "EMO" are available.



■ Accessories

Description	Type	Color
 (KKD05-263)	AR9R008	Yellow
Legend plate for AR9R008 emergency off  (KKD05-262)	AR9P721-5C	Yellow (Black legend)

■ Emergency stop pushbutton switches

Operator	Contact	Type	Color
 (KKD05-261)	1NC	AR22V3R-01RZ286	Red (White legend)
	1NO+1NC	AR22V3R-11RZ286	
	2NC	AR22V3R-02RZ286	
	1NO+2NC	AR22V3R-12RZ286	
	3NC	AR22V3R-03RZ286	
	1NO+3NC	AR22V3R-13RZ286	
	2NO+2NC	AR22V3R-22RZ286	
	4NC	AR22V3R-04RZ286	

Note : Contact arrangements indicated in the table can be supplied.

■ Dimensions, mm

● Guardring (AR9R008)

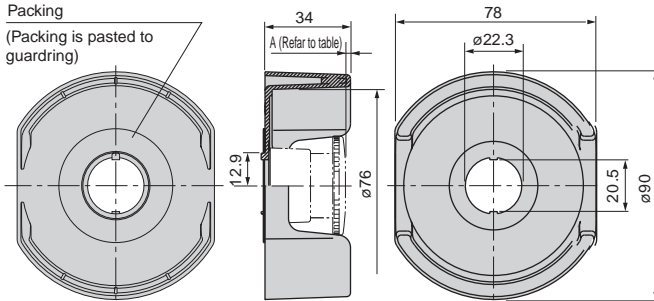

● Installation

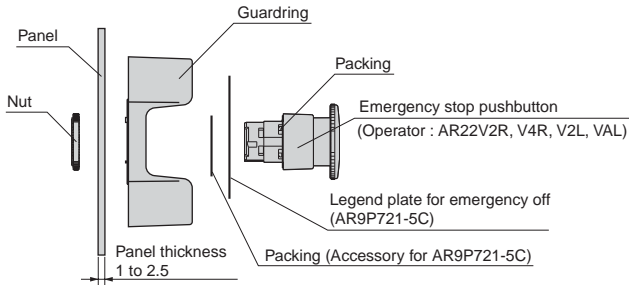

● Legend plate for emergency off (AR9P721-5C)

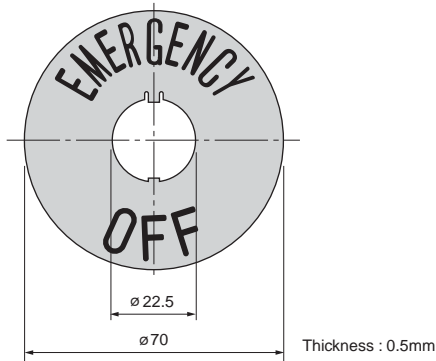

Note : • Engraving for marking letters is not available.
• Letter height : 13mm

■ Notes on use

This guardring conform to SEMI standard. Please do not use it for the emergency stops other than Semiconductor manufacturing Equipment.

■ Applicable types

AR22V2R, V4R, V2L, VAL and V3R Z286

* Dimension A (the height difference between the switch and guardring) depends on the emergency stop (Illuminated) pushbutton switch that is being used. Refer to the following table.

Type	Panel thickness	A (Reference)
AR22V2R	1~2.5	2mm With AR9P721-5C
AR22V4R	1~2.5	2mm With AR9P721-5C
AR22V2L	1~2.5	2mm With AR9P721-5C
AR22VAL	1~2.5	2mm With AR9P721-5C
AR22V3R (Z286)	1~3.6	3mm

● Panel cutout hole dimensions, mm

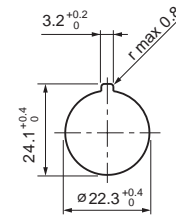

● Emergency stop pushbutton switches (AR22V3R-□□RZ286)

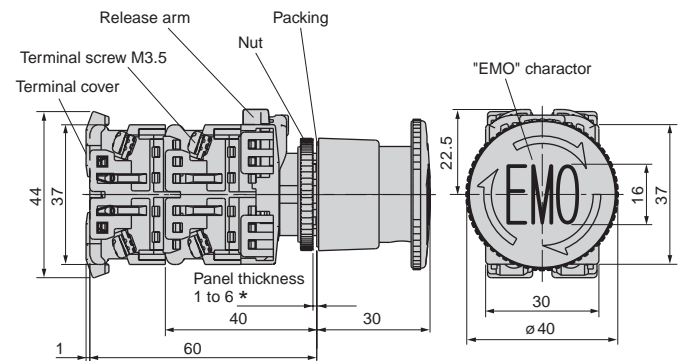

* Without accessories

Pushbuttons/Selectors/Pilot Lights/Buzzers

AR22/DR22 and AR30/DR30

Special products

Products equipped with contact protection cover

■ Features

A silicon rubber cover is provided for the contact block to keep out foreign matter such as dust, etc.
Other ratings and specifications are the same as those of the standard type.

■ Type

AR22 □ Z8

AR30 □ Z8

Specify "Z8" at the end of the type number of the standard type.

■ Dimensions

The only thing different from the standard product is the addition of a 1-mm thick silicon rubber cover around the contact block.

■ Applicable types

Type	Contact arrangement	Remarks
• Pushbuttons *1 • Emergency stop pushbuttons *2 • Selectors *3	1NO+1NC, 2NO*5, 2NC	For use with a 1-step contact
	1NO+3NC, 2NO+2NC, 3NO+1NC, 4NO*5, 4NC	For use with a 2-step contact
• Illuminated pushbuttons *4 (without transformer)	1NO*6, 1NC	For use with a 1-step contact
• Emergency stop illuminated pushbuttons*2 (without transformer)	1NO+2NC, 2NO+1NC, 3NO*6, 3NC	For use with a 2-step contact
• Illuminated selectors (without transformer)		

Notes: *1 Except for AR30B0R, B1R, B2R, B3R, N0R, and GPR.

*2 Except for unibody (VG types)

*3 Except for AR30HR

*4 Except for AR30Q7L

*5 Except for emergency stop pushbutton switch

*6 Except for emergency stop illuminated pushbutton switch

Resisting water-soluble cutting oils and heat

■ Features

Safer operation in environments exposed to water-miscible cutting fluids, machining oils, lubricating oils, cleaning oils and high humidity (up to 95%) is made possible by using materials that protect against rust and corrosion of components.
Other ratings and specifications are the same as those of the standard type.

■ Type

AR22 □ Z9, DR22 □ Z9

AR30 □ Z9, DR30 □ Z9

Specify "Z9" at the end of the type number of the standard type.

■ Dimensions

Same as those of the standard type

■ Applicable types

• AR22, DR22 series

AR 22 (Except for joy stick selectors, FAR, FBR, EAR, EBR types and VG types)

DR22 (Except for pilot lights with resistor unit and buzzers)

• AR30, DR30 series

AR30 (Except for Q7L, FAR, FBR, EAR, EBR, HR types and joy stick selectors)

DR30 (Except for D1L, F4M, F4N, M4M types, pilot lights with resistor/resistor unit and buzzers)

Meeting IP2X finger protection standards

■ Features

Conforms to EN standard EN60204-1 (protecting against electric shock). The terminal has IEC60529 degree of protection; IP2X finger protection secured (a mock human finger used in testing did not come into contact with charged parts). The contact block and lamp terminal can be easily mounted or removed with the terminal cover mounted.

■ Type

AR22 □ ZB, **DR22** □ ZB

AR30 □ ZB, **DR30** □ ZB

Specify "ZB" at the end of the type number of the standard type.

■ Accessories

- Contact block (plus terminal cover)
 NO contact: AR9B290-D
 NC contact: AR9B291-D
- Transformer unit (plus terminal cover)
 AR9T511-□ D

■ Ratings and specifications

- Protection degree: IP2X
- Terminal screw: M3.5
 Wiring can be done with a solid wire or fork shaped crimp terminal.

Note: Ring-type crimp terminals cannot be used.

- Other ratings and specifications are the same as those of the standard type.

■ Applicable types

- AR22, DR22 series
 AR22 (except for joy stick selectors)
 DR22: Without transformer, with transformer (except for short-body types, buzzers and numerical indicators)
- AR30, DR30 series
 AR30 (except for HR and joy stick selectors)
 DR30: Without transformer, with transformer (except for D1L, F4M, F4N, M4M types and buzzers)

Note: The terminal of the standard type VG has IP2X protection.

■ Dimensions, mm

AR22/Pushbutton switches

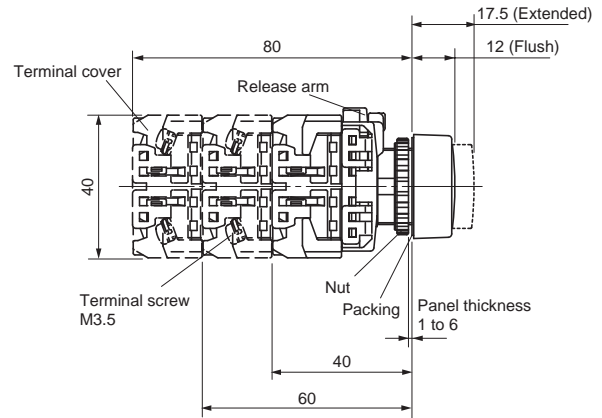

DR22/Without transformer

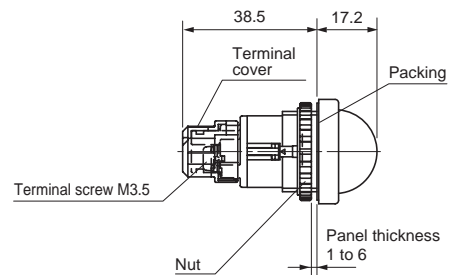

DR22/With transformer

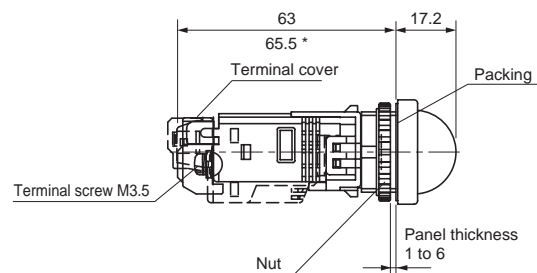

Note: * Except for the types 110V AC, 127V AC and 220V AC.

Pushbuttons/Selectors/Pilot Lights/Buzzers

AR22/DR22 and AR30/DR30

Special products

Metal nut (chrome plated) types

■ Features

The nut is a metallic ring (chrome plated).
Other ratings and specifications are the same as those of the standard model.

■ Type

AR30 ZM

DR30 ZM

Specify "ZM" at the end of the type number of the standard type.

■ Dimensions, mm

Same as those of the standard types.

■ Applicable types

• AR30, DR30 series

AR30 (except for G4L, G9L, GSR*1, GPR*1, BOR*1, and HR*1 types)

DR30 with round bezel (except for IP54 buzzer type B8)*2

Notes: *1 Standard type is a metallic ring (chrome plated).

*2 The nut of types DR30B0, B5 and B6 buzzers are resin (chrome plated).

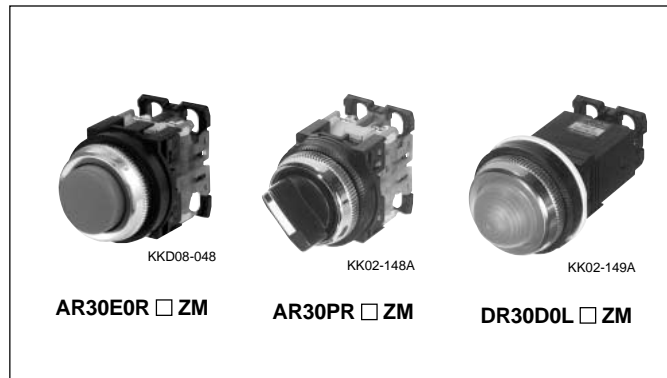

Resisting sulfuration gas

■ Features

These products can be used in environments having a concentration of hydrogen sulfide gas of 0.5 ppm or less. The metallic parts have been subjected to an anti-corrosion treatment (see note).

The contacts of the AR series are gold plated.

Note: The body is made of resin and cannot be used with gases that affect resins (plastics).

■ Type

AR22 Z4, DR22 Z4

AR30 Z4, DR30 Z4

Specify "Z4" at the end of the type number of the standard type.

■ Notes on use

- This product is resistant to light corrosive gas exposure.
- Other measures, such as covering the entire switch with a box, and the degree of protection of the panel should be taken into consideration.

■ Ratings and specifications

Hydrogen sulfide gas concentration of 0.5 ppm max.

Ambient storage temperature: 8 to 37°C

Humidity: 62 to 81%

Other ratings and specifications are the same as those of the standard type.

■ Dimensions, mm

Same as those of the standard types.

■ Applicable types

• AR22, DR22 series

AR22 (except for Joy stick selectors and VG type)

DR22 (except for pilot lights with resistor unit and buzzers)

• AR30, DR30 series

AR30 (except for HR and Joy stick selectors)

DR30 (except for F4M, F4N, M4M types, pilot lights with resistor/resistor unit and buzzers)

■ Mass, gram

● Illuminated pushbuttons

Type	Without transformer			With transformer *	
	1NO (1NC)	2NO (2NC) (1NO+1NC)	2NO+2NC	1NO (1NC)	2NO (2NC) (1NO+1NC)
AR22F0L	39	48	67	85	94
F5L	39	48	–	85	94
F0M, F0P	40	49	68	86	95
F5M, F5P	40	49	–	86	95
E0L	41	50	69	87	96
E5L	41	50	–	87	96
E0M, E0P, M4L, G1L, G2L, G4L	42	51	70	88	97
E5M, E5P, M9L, G6L, G7L, G9L	42	51	–	88	97
M4P	43	52	71	89	98
M0L	44	53	72	90	99
M5L	44	53	–	90	99
V5L	48	57	–	94	103

Note: * 230V and over : +17grams

● Pushbuttons

Type	1NO (1NC)	2NO (2NC) (1NO+1NC)	2NO+2NC
AR22F0R, FAR, F5R, FBR	27	36	55
E0R, EAR, F0S, F0Y, G0R	28	37	56
E5R, EBR, F5S, F5Y, G5R			
E0S, E0Y, M4R, G2R	29	38	57
E5S, E5Y, M9R, G7R			
M0R, M5R	31	40	59
S1R, S2R, S3R, S6R	–	43	62
M3R, M8R	44	53	72
V5R	49	58	77

● Emergency stop pushbuttons

Type	1NC	2NC (1NO+1NC)	2NO+2NC
AR22VSR	34	43	62
V0R, V4R	36	45	64
Q2R	36	45	–
V2R	38	47	66
V7R	59	68	87
VGE	61	65	–

● Emergency stop illuminated pushbuttons

Type	Without transformer		With transformer *	
	1NC	2NC (1NO+1NC)	1NC	2NC (1NO+1NC)
AR22VSL, VDL	48	57	94	103
V0L	49	58	95	104
VAL	50	59	96	105
V2L	51	60	97	106
VGF	66	70	–	–

Note: * 230V and over : +17grams

Pushbuttons/Selectors/Pilot Lights/Buzzers

AR22 and DR22

Mass

■ Mass, gram

● Pilot lights

Type	Without transformer		With transformer		With resistor unit
	Standard	Short-body	Standard *	Short-body	
DR22D0L, K0L	18	23	70	68	32
E3L, E3P, F3M, F4M	19	24	71	69	33
F5M	20	25	72	70	34
E3M	21	26	73	71	35
E3N	23	28	75	73	37

Note: * 230V and over : +17grams

● Selector switches

Type	1NO	2NO	2NO+2NC
	(1NC)	(2NC) (1NO+1NC)	
AR22PR	30	39	58
PCR	–	39	58
WR	31	40	59
WCR	–	40	59
RR, PY, WY	32	41	60
RCR, PCY, WCY	–	41	60
RY	33	42	61
RCY	–	42	61
JR, JAR	56	65	83
JCR	–	65	83
JY	57	66	84
JCY	–	66	84

● Illuminated selector switches

Type	Without transformer			With transformer *	
	1NO	2NO	2NO+2NC	1NO	2NO
	(1NC)	(2NC) (1NO+1NC)		(1NC)	(2NC) (1NO+1NC)
AR22PL	42	51	70	88	97
PP	43	52	71	89	98

Note: * 230V and over : +17grams

● Joy stick selector switches

• Screw terminal types

Type	1NO x2	(1NO+1NC) x2	1NO x4	(1NO+1NC) x4
AR22A2N, A7N	89	99	116	136
A0N, A5N	99	109	126	146
A1N, A6N	112	122	139	159

• Solder/tab terminal types

Type	(1NO+1NC) x2	(2NO+2NC) x2	(1NO+1NC) x4	(2NO+2NC) x4
AR22A2H, A7H	72	75	82	88
A0H, A5H	82	85	92	98
A1H, A6H	95	98	105	111

● Buzzers

Type	Without transformer	With transformer	With resistor unit
DR22B5	50	105	52
B8	53	108	55
B3	66	121	–

■ Mass, gram

● Illuminated pushbuttons

Type	Without transformer			With transformer *	
	1NO (1NC)	2NO (2NC) (1NO+1NC)	2NO+2NC	1NO (1NC)	2NO (2NC) (1NO+1NC)
AR30E0L	49	58	77	95	104
E5L	49	58	–	95	104
G4L	50	59	78	96	105
G9L	50	59	–	96	105
V5L	56	65	–	102	111
G2L	66	75	94	112	121
G7L	66	75	–	112	121
G3L	72	81	100	118	127
G8L	72	81	–	118	127
Q7L	–	159	–	–	205

Note: * 230V and over : +17grams

● Pushbuttons

Type	1NO (1NC)	2NO (2NC) (1NO+1NC)	2NO+2NC
AR30F0R, FAR, F5R, FBR	36	45	64
E0R, EAR, G0R, E5R, EBR, G5R	37	46	65
M4R	38	47	66
M0R, M5R	40	49	68
V5R	42	51	70
S1R, S2R, S3R, S6R	–	53	72
FVR	54	63	82
G1R, G6R	59	68	87
N0R	96	105	124
GPR	116	125	144
GSR, B0R	123	132	151
M3R, M8R	126	135	154
B1R	241	250	269
B3R	279	288	307
B2R	291	300	319

● Emergency stop pushbuttons

Type	1NC	2NC (1NO+1NC)	2NO+2NC
AR30V0R	43	52	71
Q2R	45	54	–
V2R	46	55	74
V1R	60	69	88

● Emergency stop illuminated pushbuttons

Type	Without transformer		With transformer *	
	1NC	2NC (1NO+1NC)	1NC	2NC (1NO+1NC)
AR30V0L	57	66	103	112
V2L	59	68	105	114

Note: * 230V and over : +17grams

Pushbuttons/Selectors/Pilot Lights/Buzzers

AR30 and DR30

Mass

■ Mass, gram

● Pilot lights

• Without transformer type, With transformer type, With resistor unit type

Type	Without transformer Standard	With transformer Standard *1	Short-body	With resistor unit
DR30D0L, K0L	28	80	78	42
E3L	29	81	79	43
F4M *2	32 (30)	84 (82)	–	46
F4N *2	34 (30)	86 (82)	–	48
M4M *2	37 (32)	88 (84)	–	50
D1L	94	164	–	111

Notes: *1 230V and over : +17grams

*2 (): Incandescent lamp

• With resistor type

Type	50V DC	110V DC 220V DC
DR30D0L, K0L (LED)	103	103
D0L, K0L (incandescent)	107	179

● Selector switches

Type	1NO (1NC)	2NO (2NC) (1NO+1NC)	2NO+2NC
AR30PR, WR	41	50	69
PCR, WCR	–	50	69
JR, JAR	67	76	94
JCR	–	76	94
HR	125	135	153(166)

Note: (): AR30HR-122

● Illuminated selector switches

Type	Without transformer			With transformer *	
	1NO (1NC)	2NO (2NC) (1NO+1NC)	2NO+2NC	1NO (1NC)	2NO (2NC) (1NO+1NC)
AR30PL	52	61	80	98	107

Note: * 230V and over : +17grams

● Joy stick selector switches

• Screw terminal type

Type	1NO x2	(1NO+1NC) x2	1NO x4	(1NO+1NC) x4
AR30A2N, A7N	100	110	127	147
A0N, A5N	110	120	137	157
A1N, A6N	124	134	151	171

• Solder/tab terminal type

Type	(1NO+1NC) x2	(2NO+2NC) x2	(1NO+1NC) x4	(2NO+2NC) x4
AR30A2H, A7H	83	86	93	99
A0H, A5H	93	96	103	109
A1H, A6H	107	110	117	123

● Buzzers

Type	Without transformer	With transformer	With resistor unit
DR30B5, B6	47	102	49 (Except B6)
B8	48	103	50
B0	86	–	–