

D9 line User manual

Table of contents

- Resources
- Operating modes
- Model code
- Table and description of standard parameters
- Technical specifications
- Commands
- Communications parameters reset
- Serial communications connection example
- Warranty

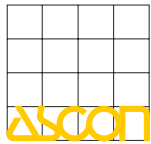

ASCON spa
ISO 9001
Certified

ASCON spa
Via Falzarego 9/11
20021 Baranzate
(Milano) Italy
Fax +39 02 350 4243
http://www.ascon.it
e-mail info@ascon.it

DIN rail mounting 2 channels data acquisition module



D9 line

Installation manual • M.U. D9-3/08.04 • Cod. J30-478-1AD9 IE

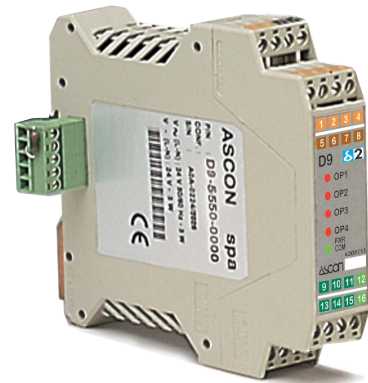

Resources

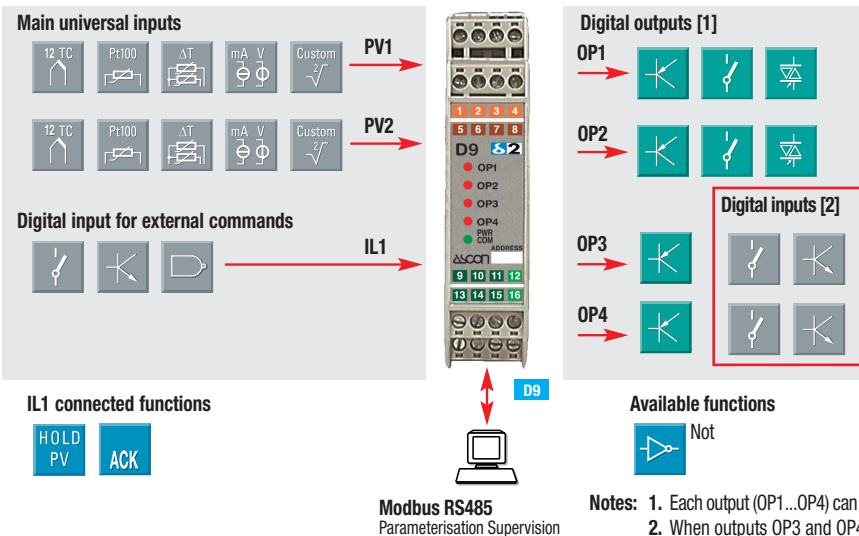

Operating modes

		Operating mode	Alarms			
PV1	1	Acquisition	OP1	OP2	OP3	OP4
PV2	2	Acquisition				
PV1	3	Acquisition	OP1	OP2	OP3	
PV2	4	Acquisition				OP4
PV1	5	Acquisition	OP1	OP2		
PV2	6	Acquisition			OP3	OP4

Model code

Mod. **D9** **5B50** - **0F00** / **ILMN** - **0000**

Line Basic Accessories 1st part 2nd part

The product code indicates the specific hardware configuration of the instrument, that can be modified by specialized engineers only

Line **D9**

Output OP1-OP2	User manual
Relay - Relay	Italian - English (std)
Relay - SSR Drive	French - English
SSR Drive - SSR Drive	German - English
SSR - SSR	Spanish - English
SSR - SSR Drive	

Input type	Range	PV1	I	L
Input type	Range	PV2	M	N
TR Pt100 IEC751	-99.9...300.0 °C	-99.9...572.0 °F	0	0
TR Pt100 IEC751	-200...600 °C	-328...1112 °F	0	1
TC L Fe-Const DIN43710	0...600 °C	32...1112 °F	0	2
TC J Fe-Cu45% Ni IEC584	0...600 °C	32...1112 °F	0	3
TC T Cu-CuNi	-200...400 °C	-328...752 °F	0	4
TC K Chromel -Alumel IEC584	0...1200 °C	32...2192 °F	0	5
TC S Pt10%Rh-Pt IEC584	0...1600 °C	32...2912 °F	0	6
TC R Pt13%Rh-Pt IEC584	0...1600 °C	32...2912 °F	0	7
TC B Pt30%Rh-Pt Pt6%Rh IEC584	0...1800 °C	32...3272 °F	0	8
TC N Nichrosil-Nisil IEC584	0...1200 °C	32...2192 °F	0	9
TC E Ni10%Cr-CuNi IEC584	0...600 °C	32...1112 °F	1	0
TC Ni-NiMo 18%	0...1100 °C	32...2012 °F	1	1
TC W3%Re-W25%Re	0...2000 °C	32...3632 °F	1	2
TC W5%Re-W26%Re	0...2000 °C	32...3632 °F	1	3
0...50mV linear	Engineering units		1	4
10...50mV linear	Engineering units		1	5
mV "Custom" input range	On request		1	6

Table of standard parameters

If not specified, each the parameter must be doubled: one set for LOOP1 and one set for LOOP2. If the parameter is unique (1 parameter for both the loops) it is pointed out in the notes column

Configuration					
Mnemonic code	Parameter description	Setting range	Unit	Factory setting	Notes
IL	Digital input function IL	see table 1		not used	Valid for both the channels
Prot	Communication protocol	M.bus/Jbus		M.bus	
baud	Baud rate	1200, 2400, 4800, 9600 baud		9600	
PStr	Instrument position	Alone/left side/central/right side		Alone	
Unit	Engineering unit	see table 2		none	
Sc.dd	N° of decimals	0...3		0	Linear scales only
Sc.Hi	Low range	-999...9999	Engineering unit	Low range	Range min. 100 digit (linear scales only)
Sc.Lo	High range	-999...9999	Engineering unit	High range	
Alarms and auxiliary					
Mnemonic code	Parameter description	Setting range	Unit	Factory setting	Notes
A1hy	AL1 hysteresis	0.1...10.0	% range	0.5	The same parameters are available also for AL2, AL3 and AL4 alarms
A1SR	AL1 alarm source	Loop 1/loop 2		Loop 1	
A1.tp	AL1 alarm type	See table 3		Inhibited	
A1Lb	Latching/blocking alarm functions	None/Ltch/Bloc/LtbL		None	
A1.O	AL1 output	Internal status/OP1/OP2/OP3/OP4		Internal status	
t.Fil	Filter time constant	OFF/1...30	s	Inhibited	
In.Sh	Input shift	OFF/-60...+60	Digit	Inhibited	
Addr	Communications address	1...247		247	Valid for both the channels
Hi.PV	PV (measure) Hold	0/1		0	
OP.Ik	Output lock	0/1		0	Locks the outputs OP1, OP2, OP3, OP4
Ack	Alarms acknowledge	0/1		0	Valid for both the channels
Nt.O1	Negate (NOT) OP1	0/1		0	Available also for OP2 - OP3 - OP4
RF.L	RF low range	low range...RF. H	Engineering unit	----	
RF.H	RF high range	RF. L...high range	Engineering unit	----	
RF	Reference value	range	Engineering unit	----	

Standard parameters description

The parameters shown in the table are divided into groups which work in the same way. Below they will be described as they are listed in the table.

Configuration	Setpoint (SP)	Auxiliary parameters																								
<p>IL Digital input function - Table 1</p> <table border="1" style="width: 100%; border-collapse: collapse;"> <tr><td style="background-color: #D3D3D3;">Parameter description</td><td></td></tr> <tr><td>Not used</td><td></td></tr> <tr><td>Loop 1 measure hold</td><td></td></tr> <tr><td>Loop 2 measure hold</td><td></td></tr> <tr><td>Hold both the measuring loops</td><td></td></tr> <tr><td>Output locks</td><td></td></tr> <tr><td>Alarms acknowledge</td><td></td></tr> </table>	Parameter description		Not used		Loop 1 measure hold		Loop 2 measure hold		Hold both the measuring loops		Output locks		Alarms acknowledge		<p>A1S.P AL1 - AL2 - AL3 - AL4 threshold A2S.P Alarm occurrences of AL1, AL2, AL3 and OP4. A3S.P The range of the alarm threshold correspond to the whole span and it is not A4S.P limited by the SP Setpoint span.</p>	<p>A1.tp Alarm type A2.tp The parameter allows to specify how each A3.tp should function. A4.tp The types of alarm available are:</p> <table border="1" style="width: 100%; border-collapse: collapse;"> <thead> <tr style="background-color: #D3D3D3;"><th>Value</th><th>Action</th></tr> </thead> <tbody> <tr><td>0</td><td>Disable</td></tr> <tr><td>1</td><td>Sensor/Loop Break</td></tr> <tr><td>2</td><td>Absolute high</td></tr> <tr><td>3</td><td>Absolute low</td></tr> </tbody> </table>	Value	Action	0	Disable	1	Sensor/Loop Break	2	Absolute high	3	Absolute low
Parameter description																										
Not used																										
Loop 1 measure hold																										
Loop 2 measure hold																										
Hold both the measuring loops																										
Output locks																										
Alarms acknowledge																										
Value	Action																									
0	Disable																									
1	Sensor/Loop Break																									
2	Absolute high																									
3	Absolute low																									
<p>unit Engineering units - Table 2</p> <table border="1" style="width: 100%; border-collapse: collapse;"> <thead> <tr style="background-color: #D3D3D3;"><th>Parameter description</th><th>Parameter description</th></tr> </thead> <tbody> <tr><td>°C (Centigrade degrees)</td><td>A (Ampere)</td></tr> <tr><td>°F (Fahrenheit degrees)</td><td>bar</td></tr> <tr><td>None</td><td>psi</td></tr> <tr><td>mV (millivolt)</td><td>Rh</td></tr> <tr><td>V (Volt)</td><td>pH</td></tr> <tr><td>mA (milliampere)</td><td></td></tr> </tbody> </table>	Parameter description	Parameter description	°C (Centigrade degrees)	A (Ampere)	°F (Fahrenheit degrees)	bar	None	psi	mV (millivolt)	Rh	V (Volt)	pH	mA (milliampere)			<p>In.Sh Input shift This function shifts the whole PV scale of up to ±60 digits.</p> <p>Addr Controller address The address range is from 1 to 247 and must be unique for each instrument on the communications bus to the supervisor.</p>										
Parameter description	Parameter description																									
°C (Centigrade degrees)	A (Ampere)																									
°F (Fahrenheit degrees)	bar																									
None	psi																									
mV (millivolt)	Rh																									
V (Volt)	pH																									
mA (milliampere)																										

For each alarm is possible to configure:

A - Source

B - The type and the operating condition of the alarm

C - The functionality of the alarm acknowledgement

D - The blocking function on start-up

E - Loop break or sensor break

F - Output linked to each alarm

A - Source

A1Sr Alarm source
A2Sr Each alarm AL1, AL2, AL3 and AL4 can be freely associated to one of the two input channels.
A3Sr The threshold is compared with the Setpoint of the selected channel (SP).
A4Sr

B - Alarm type and function

A1tp Absolute alarm
A2tp On Active high
A3tp On Active low
A4tp Off

C/D - Latching, blocking and acknowledge functions enable

A1L.b AL1, AL2, AL3 and AL4 latching and blocking
A2L.b For each alarm it is possible to select the following functions:
A3L.b
A4L.b

- None
- Latching
- Blocking
- Both latching and blocking

Alarm acknowledge function
 The alarm, once occurred, is maintained until to the time of acknowledgement. The acknowledge operation is performed by serial communications. **ack**
After this operation, the alarm leaves the alarm state only when the alarm condition is no longer present.

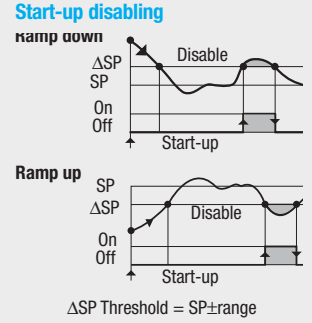

F - Alarm addressing

A1.O Physical Output linked to the alarm
A2.O One or more alarms (OR function) can be linked to the physical outputs OP1...OP4.
A3.O The parameter can assume the following values: Internal status, OP1, OP2, OP3, OP4.
A4.O

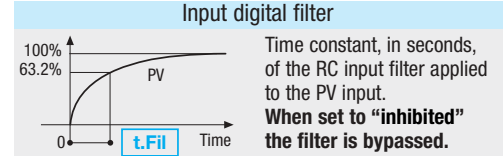

Technical specifications

Features (at 25°C T. env.)	Description			
Total configurability	By means of the configuration tool it is possible to select: - type of input - type of output - type and functionality of the alarms			
PV1 and PV2 inputs	Common characteristics	A/D converter with resolution of 50,000 points Update measurement time: 0.2 s Sampling time: 0.5 s (max. measurement updating time) Input bias: -60...+60 digit Input filter: 1...30 s (0 = OFF)		
	Accuracy	0.25% ±1 digit (for temperature sensor) 0.1% ±1 digit (for mA and mV)		
	Resistance thermometer (for ΔT : R1+R2 must be <320Ω)	Pt100Ω at 0°C(IEC 751) °C/°F selectable		
	Thermocouple	L, J, T, K, S, R, B, N, E, W3, W5 (IEC 584) °C/°F selectable		
	DC input (current)	0/4...20mA, 2.5Ω ext. shunt $R_j > 10M\Omega$		
	DC input (voltage)	10...50mV, 0...50mV $R_j > 10M\Omega$		
	Mutual isolation	Isolation voltage 500V		
Digital input	Closing the external contact allows: Measure hold, alarms acknowledge, outputs lock			
Operating mode	2 acquisition channels with 1, 2, 3 or 4 alarms			
OP1 - OP2 outputs	SPST relay NO, 2A/250Vac (4A/120 Vac) for resistive load SSR, 1A/250Vac for resistive load SSR drive: 0/5Vdc, ±10% 30 mA max. To meet the double isolation requirements, OP1 and OP2 must have the same load type			
OP3 - OP4 outputs	Non isolated logic: 0/5Vdc, ±10% 30 mA max.			
Outputs functions	For all the outputs the inversion function (NOT) is available			
AL1 - AL2 AL3 - AL4 alarms	Hysteresis	0.1...10.0%		
	Action	Active high	Action type	Absolute threshold on the whole range
		Active low	Special functions	Sensor break, Loop break Alarm acknowledge (latching), activation inhibit (blocking)
	Alarm source	Assignes the alarms to PV1 or PV2		
Alarm output	Assignes the alarm condition to an output (OP1, OP2, OP3, OP4). If not configured, the alarm status is available on the coil			
Serial communications	RS 485 isolated, Modbus/Jbus protocol, 1,200, 2,400, 4,800, 9,600 bit/s 2 wires			
Operational safety	Measure input	Detection of out of range, or input problems causes automatic activation of the safety strategies		
	Parameters Outputs lock	Parameters and configuration data are stored in a non volatile memory for an unlimited time		
General characteristics	Power supply (PTC protected)	24Vac (-25...+12%) 50/60Hz and 24Vdc (-15...+25%)	Power consumption 3 W max.	
	Safety	EN61010-1 (IEC1010-1), installation class 2 (2.5kV), pollution degree 2, instrument class II		
	Electromagnetic compatibility	Compliance with the CE standards		
	UL and cUL Approval	File E176452		
	Protection	Terminal blocks: IP20		
	Dimensions	Pitch: 22.5 mm - height: 99 mm - depth: 114.5 mm - height: 53 mm		
Weight	156 g approx.			

Commands

Alarms acknowledge

Ack

The acknowledge operation is performed by serial communications.

Negate output status

Nt.Ox

It is possible to enable, separately for each output (DO1... DO4), the negate (NOT) function of the output internal logic status.

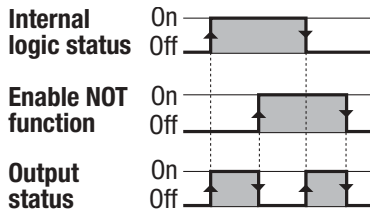

PV Measure Hold

Hi.PV

Through the digital input IL is possible to hold the value of the PV measure (PV1, PV2 or PV1 and PV2).

Outputs lock

OP.Ik

Output ports can be switched to OFF through the serial communications port.

⚠ Outputs lock status is maintained if the module is powered OFF

Digital input commands

Function	Performed operation		Notes
	Off	On	
None			Not used
Hold PV1 measure	Normal operation	PV1 is hold	The value of PV (PV1 or/and PV2) is "frozen" at the time the digital input goes to the close state
Hold PV2 measure	Normal operation	PV2 is hold	
Hold PV1 and PV2 measures	Normal operation	PV1 and PV2 are hold	
Outputs lock	Outputs status not influenced	Outputs in OFF status	The digital IL command inhibits all the outputs at the same time
Alarms acknowledge	Alarms active	Alarms acknowledged	The digital IL command acknowledges all the alarms active at the same time

A function can be assigned, through the configuration procedure, to digital input. The configured function is activated when the digital input (free voltage contact or open collector output) is in the ON status (closed). The function is reset to the normal operation by setting the input to the OFF status (open).

Activating the function through the digital input has the highest priority than the keypad or the serial communications command activation.

Communications parameters reset

The serial communications parameters can be reset to the original factory settings (protocol: Modbus, Baud Rate: 9600, Address: 247).

The instructions to remove/re-insert the I/O module from/in its plastic case are described in the "Installation manual".

After having removed the module, use the instructions that follow to reset the communications parameters:

- 1) Use a jumper to short-circuit the terminals shown in the drawing that follows;
- 2) Insert the I/O module in its housing and power ON the instrument;
- 3) Extract the I/O module from its plastic case and remove the short circuit jumper;
- 4) Reinstall the module in its housing.

At the end of this procedure, the communications parameters will be reset to its factory settings.

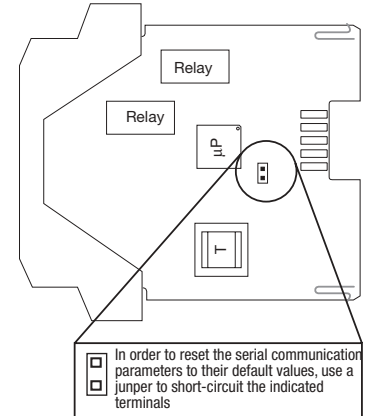

Serial communications connection example

Configuration

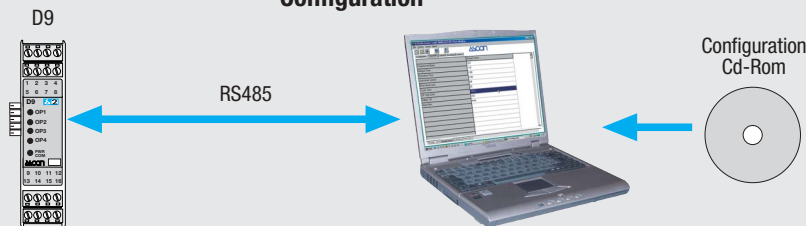

For SCADA

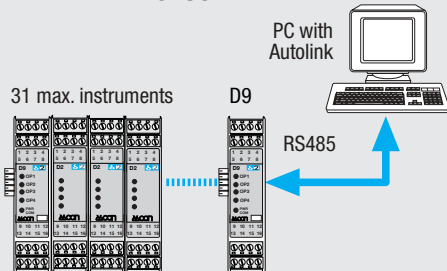

Local control

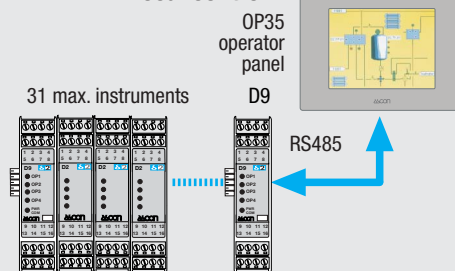

Warranty

We warrant that the products will be free from defects in material and workmanship for 3 years from the date of delivery.

The warranty above shall not apply for any failure caused by the use of the product not in line with the instructions reported on this manual.