

Product Highlights

Overview of our timing- and monitoring relays, load monitors, grid and system protection and complementary products



Technology for More Time and Greater Security



We are the Austrian market leader for timing and monitoring relays. Our relays might be small but they pack a punch.

- ✓ **Wide range of timing relay products**
- ✓ **Monitoring devices for physical quantities such as current, voltage, temperature, frequency, level, power factor, active power ...**
- ✓ **Provider of high-quality industrial switching relays and power electronics**
- ✓ **Extensive technical expertise thanks to 50 years of experience**
- ✓ **Global sales network**

Tele Haase was founded in 1963 and is Austria's market leader in developing state-of-the-art monitoring, control and automation technology..

Tele relays function dependably in water treatment plants, transformer stations and industrial plants and are used during renewable energy generation in wind, hydroelectric and solar power plants.

Tele developments meet international quality standards and contribute to environmentally friendly generation of renewable energy using water, wind and the sun.

Tele Haase, as a company of the future, has set out to help actively shape social change toward sustainability over the long term by obtaining maximum energy and using this energy as carefully and effectively as possible.

Our some 90 highly qualified employees fulfill the high requirements and requests of our customers day in, day out.

TELE Haase produces one-hundred percent of its core products in Austria. Research and development as well as production at our head office in Vienna are our core areas of expertise. Our sales team and more than 50 international trade partners make up our global sales network.



Product classes

Our product range consists of the following high quality products:

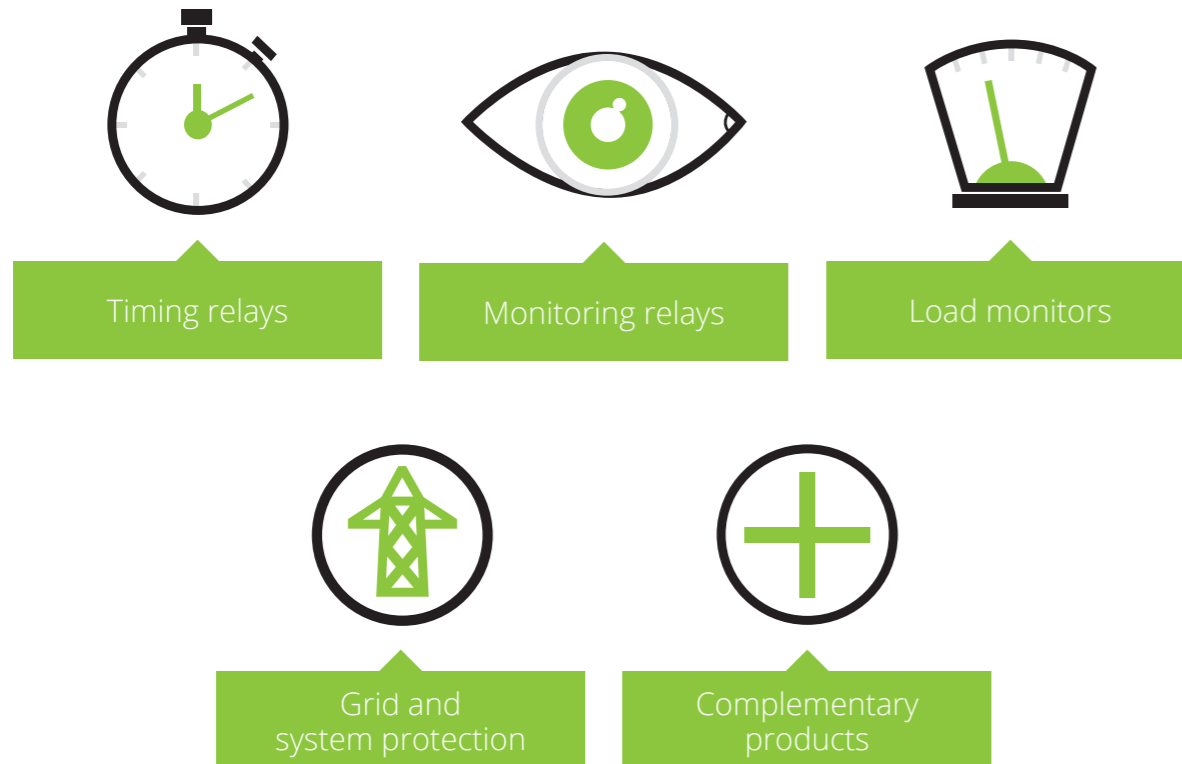

Timing relays can make system and machine operation even more efficient. They check the time for you, for example if wind turbines need to be switched off or if it's time to fertilize your grapevines for a specified length of time. Your production is never thrown off its rhythm, which saves you money.

Monitoring relays measure and monitor current, voltage, temperature, frequency, level, power factor and active power. A variety of different enclosures for control technology, industrial systems, machinery and building installations allow for flexible use of relays. The rugged design offers excellent usability and installability.

Load monitors measure such variables as the power factor of a motor or the true power of a pump or fan. These measurements provide indications and important information about the state and functioning of machinery and installations, which reduces maintenance costs, service and downtime.

Grid and system protection An automatic control station monitors the energy feedback into the 230/400 V grid. If mains power is switched off by the electricity supply company, or by a protective device, it is vital for small-scale power plants to be disconnected within a few milliseconds to ensure that maintenance personnel are not endangered and that consumers do not suffer injury or damage from excessively fluctuating voltage or frequency

Complementary products:

- Coupling units and signal converter
- Switching relays + sockets
- Current transformers
- Softstarter, Thyristor control units and braking units
- Hour meters and timers
- Safety relays
- Switching power supplies

Product series

Our large and small quartet: ENYA, VEO, GAMMA and KAPPA – play it safe!



	ENYA	VEO	GAMMA	KAPPA
Product category	Timing & monitoring relays, coupling units	Timing & monitoring relays	Timing & monitoring relays, load monitors, grid and system protection	Timing & monitoring relays
Dimensions (w x h x d)	17.5 / 35 x 87 x 65 mm	22.5 / 45 x 67 x 76 mm	22.5 / 45 x 108 x 90 mm	38 x 51 x 80 mm
Design	Installation design	Compact industrial design	Industrial design	Industrial Plug-In design, 11-poles
Labelling area	-	Freely positionable or fixed	Fixed	Fixed
Product standards	EN 61812-1 EN 60947	EN 61812-1 EN 60947	EN 61812-1 EN 50178 EN 60947	EN 61812-1 EN 50178
Energy consumption	0.8 - 1.3W	extra low: 0.35 - 0.6W	1 - 1.5W	0.8 - 2W
Electrical connection	Screw terminal	Push-in terminal or Screw terminal	Screw terminal	Plug-in Housing mounted on screw terminal socket
Overvoltage category / Rated impulse withstanding voltage	III / 4kV	III / 4/6kV (protective separation)	III / 4/6kV	III / 4kV
Application field	Building	Industrial automation	Industrial automation	Building
Base accuracy	≤ 5%	≤ 2.5%	≤ 3%	≤ 5%

FOR THE ENTIRE PRODUCT RANGE PLEASE VISIT



Product features

Each of our products is characterized by special product features:

ENYA

- ✓ Installation design (45 mm standard front dimension)
- ✓ Timing and monitoring relays, Single and Multifunction
- ✓ Width 17.5 mm and 35 mm, 1 or 2 changeover contacts (CO)
- ✓ UL listed, CE conformity marking
- ✓ Temperature range -25 to +55°C
- ✓ Recessed potentiometer buttons, analog indication by means of LED
- ✓ 12 to 240V AC/DC, powered by measuring circuit

VEO

- ✓ Industrial design for mounting plate and cable channels
- ✓ Timing and monitoring relays, Single and Multifunction
- ✓ Width 22.5 mm and 45 mm, 1 or 2 changeover contacts (CO)
- ✓ Low profile
- ✓ UL listed, CE conformity marking
- ✓ Temperature range -25 to +60°C
- ✓ Recessed potentiometer buttons, analog indication by means of LED
- ✓ 12 to 240V AC/DC, powered by measuring circuit

GAMMA

- ✓ Industrial design
- ✓ Timing and monitoring relays, Single and Multifunction
- ✓ Width 22.5 mm and 45 mm, 1 or 2 changeover contacts (CO)
- ✓ UL listed, CE conformity marking
- ✓ Temperature range -25 to +55°C
- ✓ Recessed potentiometer buttons, analog indication by means of LED, digital indication by means of LCD-Display
- ✓ 12 to 240V AC/DC, powermodules 12 to 500V AC; 24V DC

KAPPA

- ✓ Industrial Plug-In housing (45 mm standard front dimension)
- ✓ Timing and monitoring relays, Single and Multifunction
- ✓ Width 35 mm, 2 changeover contacts (2CO) or 1 changeover and 1 normally open contact (1CO + 1NO)
- ✓ CE conformity marking
- ✓ Temperature range -25 to +55°C
- ✓ Recessed potentiometer buttons, analog indication by means of LED
- ✓ 12 to 240V AC/DC, powered by measuring circuit

MORE PRODUCT INFOS



www.tele-online.com

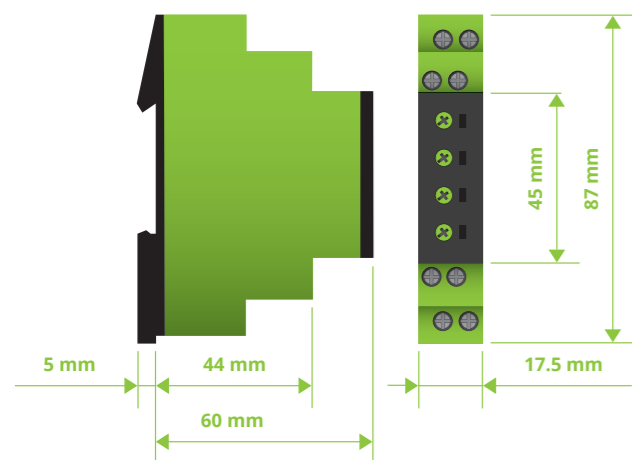

6

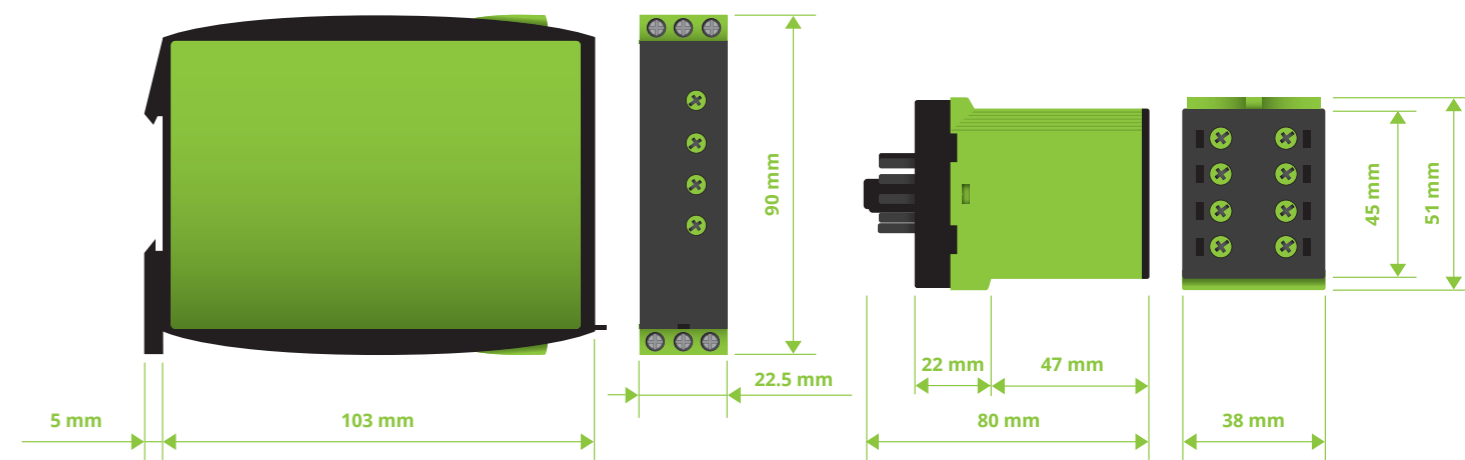
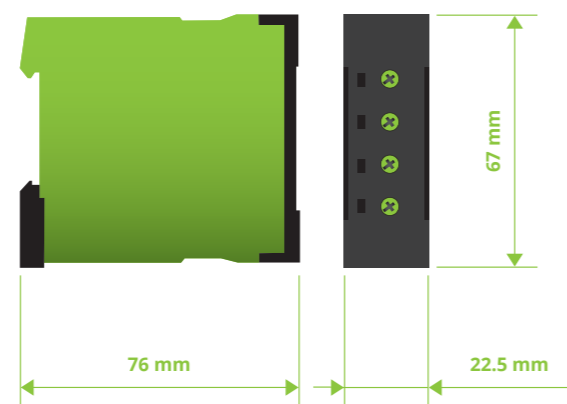

7



Function overview

timing relays

Our timing relays have a variety of functions – here they are in detail:

E	ON delay
	<p>When the supply voltage U is applied, the set interval t begins. After the interval t has expired the output relay R switches into on-position. This status remains until the supply voltage is interrupted. If the supply voltage is interrupted before the expiry of the set interval, the interval t already expired is erased and is restarted when the supply voltage is next applied.</p>
A	OFF delay without auxiliary voltage
	<p>When the supply voltage U is supplied, the output relay R switches into on-position. If the supply voltage is interrupted, the set interval t begins. After the set interval t has expired the output relay R switches into off-position. If the supply voltage is reconnected before the interval t has expired the interval already is erased and is restarted with the next cycle.</p>
R	OFF delay
	<p>The supply voltage U must be constantly applied to the device. When the control contact S is closed, the output relay R switches into on-position. If the control contact is opened, the set interval t begins. After the interval t has expired the output relay switches into off-position. If the control contact is closed again before the set interval has expired, the interval already expired is erased and is restarted.</p>
S	Star-Delta Start-up
	<p>When the supply voltage U is applied, the star-contact switches into on-position and the set star-time t1 begins. After the interval t1 has expired the star-contact switches into off-position and the set transit-time t2 begins. After the interval t2 has expired the delta-contact switches into on-position. To restart the function the supply voltage must be interrupted and re-applied.</p>
ER	ON delay and OFF delay with control contact
	<p>The supply voltage U must be constantly applied to the device. When the control contact S is closed, the set interval t1 begins. After the interval t1 has expired, the output relay R switches into on-position. If the control contact is opened, the set interval t2 begins. After the interval t2 has expired, the output relay switches into off-position. If the control contact is opened before the interval t1 has expired, the interval already expired is erased and is restarted with the next cycle.</p>

Ec	Additive ON Delay
	<p>When the supply voltage U is applied, the release for the interval starts. When the control contact S is closed, the set interval t begins. If the control contact S is opened during the set interval t, the interval stops, and the already expired interval is stored. During the lapse of time the control contact can be opened or closed as often as required. If the sum of the periods, in which the control contact S is closed reaches the set interval t the output relay R switches into on-position. The interval is stopped and a further activation of the control contact S remains without effect. By interrupting the supply voltage, the device will be reset. A possibly expired time t is deleted.</p>
Es	ON delay with control input
	<p>The supply voltage U must be constantly applied to the device. When the control contact S is closed, the set interval t begins. After the interval t has expired the output relay R switches into on-position. This status remains until the control contact is opened again. If the control contact is opened before the interval t has expired, the interval already expired is erased and is restarted with the next cycle.</p>
ET	ON delay two wire connected
	<p>When the supply voltage U is applied, the set interval t begins. After the interval has expired the thyristor switches on. This status remains until the supply voltage is interrupted. If the supply voltage is interrupted before the expiry of the interval, the interval already expired is erased and is restarted when the supply voltage is next applied.</p>
Wu	Single shot leading edge voltage controlled
	<p>When the supply voltage U is applied, the output relay R switches into on-position and the set interval t begins. After the interval t has expired the output relay switches into off-position. This status remains until the supply voltage is interrupted. If the supply voltage is interrupted before the interval t has expired, the output relay switches into off-position. The interval already is erased and is restarted when the supply voltage is next applied.</p>
EWu	ON delay single shot leading edge with control contact
	<p>When the supply voltage U is applied, the set interval t1 begins. After the interval t1 has expired, the output relay R switches into on-position and the set interval t2 begins. After the interval t2 has expired, the output relay switches into off-position. If the supply voltage is interrupted before the interval t1+t2 has expired, the interval already expired is erased and is restarted when the supply voltage is next applied.</p>
nWu	Maintained single shot leading edge
	<p>When the supply voltage U is applied, the output relay R switches into on-position and the set interval t begins. After the interval t has expired the output relay switches into off-position. This status remains until the supply voltage is interrupted. If the supply voltage is reconnected before the interval t has expired, the unit continues to perform the actual single shot.</p>
Ws	Single shot leading edge with control input
	<p>The supply voltage U must be constantly applied to the device. When the control contact S is closed, the set interval t begins. After the interval t has expired the output relay R switches into on-position. This status remains until the control contact is opened again. If the control contact is opened before the interval t has expired, the interval already expired is erased and is restarted with the next cycle.</p>

EWs ON delay single shot leading edge with control contact

The supply voltage U must be constantly applied to the device. When the control contact S is closed, the set interval t1 begins. After the interval t1 has expired, the output relay R switches into on-position and the set interval t2 begins. After the interval t2 has expired, the output relay switches into off-position. During the interval, the control contact can be operated any number of times. A further cycle can only be started when the cycle run has been completed.

Wa Single shot trailing edge with control input

The supply voltage U must be constantly applied to the device. Closing the control contact S has no influence on the condition of the output R. When the control contact is opened, the output relay switches into on-position and the set interval t begins. After the set interval has expired, the output relay switches into off-position. During the interval, the control contact can be operated any number of times. A further cycle can only be started when the cycle run has been completed.

nWa Maintained single shot trailing edge

When the supply voltage U is supplied, the output relay R remains into off-position. As soon as the supply voltage is interrupted the output relay switches into on-position and the set interval t begins. After the set interval t has expired the output relay switches into off-position. When the supply voltage is reconnected before the interval t has expired, the unit continues to perform the actual single shot.

nWuWa Maintained single shot leading and trailing edge

When the supply voltage U is applied, the output relay R switches into on-position and the set interval t begins. After the interval t has expired the output relay switches into off-position. As soon as the supply voltage is interrupted the output relay switches into on-position again and the set interval t begins. After the set interval t has expired the output relay switches into off-position. If the supply voltage is interrupted (nWu) or reconnected (nWa) before the interval t has expired the unit continues to perform the actual single shot.

WsWa Single shot leading and single shot trailing edge with control contact

The supply voltage U must be constantly applied to the device. When the control contact S is closed, the output relay R switches into on-position and the set interval t1 begins. After the interval t1 has expired, the output relay R switches into off-position. If the control contact is opened, the output relay again switches into on-position and the set interval t2 begins. After the interval t2 has expired the output relay switches into off-position. During the interval, the control contact can be operated any number of times.

Bi Flasher pulse first

When the supply voltage U is applied, the output relay R switches into on-position and the set interval t begins. After the interval t has expired, the output relay R switches into off-position and the set interval t begins again. The output relay is triggered at a ratio of 1:1 until the supply voltage is interrupted.

Bp Flasher pause first

When the supply voltage U is applied, the set interval t begins. After the interval t has expired, the output relay R switches into on-position and the set interval t begins again. After the interval t has expired, the output relay switches into off-position. The output relay is triggered at a ratio of 1:1 until the supply voltage is interrupted.

Wt Asymmetric flasher pulse first

When the supply voltage U is applied, the set interval t1 begins and the output relay R switches into on-position. After the interval t1 has expired, the set interval t2 begins. So that the output relay R remains in on-position, the control contact S must be closed and opened again within the set interval t2. If this does not happen, the output relay R switches into off-position and all further pulses at the control contact are ignored. To restart the function the supply voltage must be interrupted and reapplied.

li Asymmetric flasher pulse first

When the supply voltage U is applied, the output relay R switches into on-position and the set interval t1 begins. After the interval t1 has expired, the output relay switches into off-position and the set interval t2 begins. After the interval t2 has expired, the output relay switches into on-position. The output relay is triggered at the ratio of t1:t2 until the supply voltage is interrupted.

lp Asymmetric flasher pause first

When the supply voltage U is applied, the set interval t1 begins. After the interval t1 has expired, the output relay R switches into on-position and the set interval t2 begins. After the interval t2 has expired, the output relay switches into off-position. The output relay is triggered at the ratio of t1:t2 until the supply voltage is interrupted.

T, TW Function automatic timer with (TW) or without (T) switch-off warning

After the pushbutton (control input) has been pressed, the output relay R closes and the set interval t begins. If the pushbutton is pressed again before the interval has expired, the interval begins again (restart function complies with EN 60669-2-3). Rapid, multiple pressing of the pushbutton (pumping) adds 2, 3 or more time intervals to extend the time up to 60 min. Prolonged pressure on the button (>2 s) aborts the interval running and switches the relay off (energy saving function). In the TW mode the device provides a switch-off warning (in accordance with DIN 180-158-2) by generating short pulses (flashing) at 30s, 15s and 5s prior to switch-off.

P, PN Impulse switch mode

In this mode, every keypress of the pushbutton (control input) toggles the output relay R (flip-flop). In function P, the output relay remains in off-position, whenever the supply voltage is applied. In function PN, the output relay switches into on-position after applying the supply voltage U, if the output relay was in on-position last before power failure. In both functions the output relay switches into on-position, if a short voltage impulse (<2s) is applied to the additional control input (central ON). A longer voltage impulse (>2s) opens the output relay (central OFF).

P (R) Impulse switch mode with off delay





In this mode, every keypress toggles the output relay R (flip-flop). After the pushbutton (control input) has been pressed, the output relay closes and the set interval t begins. After the interval has expired the output relay switches into off-position. If the pushbutton is pressed again before the interval has expired, the interval will be canceled and the output relay switches into off-position.

TYPE DESIGNATION	E1ZM10	E1ZM20	E1ZMQ10	E1ZMW10	E3ZM20
					
ORDER INFORMATION		UL approval pending			
Art. No. single package	110100 (12-240V) 110200 (24-240V)	110210	110202	-	111100
Art. No. package 10 pcs.	110100A (12-240V) 110200A (24-240V)	-	110202A	110206A	-
FUNCTIONALITY	MULTIFUNCTION	MULTIFUNCTION	MULTIFUNCTION	MULTIFUNCTION	MULTIFUNCTION
E On delay	■	■	■	■	■
R Off delay	■	■	■	■	■
Es On delay with control contact	■	■	■	■	■
Wu Single shot leading edge, voltage-controlled	■	■	■	■	■
Ws Single shot leading edge with control contact	■	■	■	■	■
Wa Single shot trailing edge with control contact	■	■	■	■	■
Bp Flasher pause first	■	■			■
Wt Pulse repetition analysis				■	
WsWa Single shot leading and trailing edge with control contact				■	
POWER SUPPLY CIRCUIT					
Supply voltage	12 – 240V AC/DC 24 – 240V AC/DC	24 – 240V AC/DC	24 – 240V AC/DC	24 – 240V AC/DC	12 – 240V AC/DC
Setting range	48 – 63 Hz				
TIME CIRCUITS					
Time ranges	7				
Setting range	0.05 s – 100 h				
INPUT CIRCUIT					
Control signal	■	■	■	■	■
OUTPUT CIRCUIT					
Number of switch contacts	1 CO contact	1 CO, 1 NO contact	1 CO contact	1 CO contact	1 CO contact
Max. switching capacity	2000VA (8A / 250V AC)				
DESIGN					
Dimensions (w x h x d)	17.5 x 87 x 65 mm	17.5 x 87 x 65 mm	17.5 x 87 x 65 mm	17.5 x 87 x 65 mm	35 x 87 x 65 mm
Certificates	CE, cULus, GOST				





TYPE DESIGNATION	E1ZNT	E1Z1E10	E1Z110	E3Z120	E3ZS20
					
ORDER INFORMATION	UL approval pending				
Art. No. single package	110500	-	110101	111101	111300
Art. No. package 10 pcs.	-	110204A	-	-	-
FUNCTIONALITY	EMERGENCY LIGHT TESTER	ON DELAY	ASYMMETRIC FLASHER	ASYMMETRIC FLASHER	STAR DELTA
E On delay		■			
ER On delay and off delay with control contact				■	
EWu On delay single shot leading edge, voltage-controlled				■	
Ws Single shot leading edge with testkey	■				
EWs On delay single shot leading edge with control contact				■	
lp Asymmetric flasher pause first			■	■	
li Asymmetric flasher pulse first			■	■	
Wt Pulse repetition analysis				■	
WsWa Single shot leading and trailing edge with control contact				■	
S Star-Delta start-up					■
POWER SUPPLY CIRCUIT					
Supply voltage	230V AC	24 to 240V AC/DC	12 to 240V AC/DC	12 – 240V AC/DC	12 – 240V AC/DC
Frequency range	48 – 63 Hz				
TIME CIRCUITS					
Time ranges	1	7	7	7	4
Setting range	10 min – 3 h	0.05 s – 100 h	1 s – 100 h	1 s – 100 h	0.5 s – 3 min
INPUT CIRCUIT					
Control signal	Integrated test key		■	■	
OUTPUT CIRCUIT					
Number of switch contacts	1 CO contact	1 CO contact	1 CO contact	2 CO contacts	2 CO contacts
Max. switching capacity	NC: 4000VA (10A / 250V AC) NO: 1250VA (5A / 250V AC)	2000VA (8A / 250V AC)a	2000VA (8A / 250V AC)	2000VA (8A / 250V AC)	2000VA (8A / 250V AC)
DESIGN					
Dimensions (w x h x d)	17.5 x 87 x 65 mm	17.5 x 87 x 65 mm	17.5 x 87 x 65 mm	35 x 87 x 65 mm	35 x 87 x 65 mm
Certificates	CE, GOST	CE, cULus, GOST	CE, cULus, GOST	CE, cULus, GOST	CE, cULus, GOST

TYPE DESIGNATION	V2ZM10	V2ZM10-A	V2ZQ10	V2Z110	V2ZE10
					
ORDER INFORMATION					
Art. No. Screw terminal	125100	-	125150	125200	125110
Art. No. Push-in terminal	125600	-	125650	125210	125610
Art. No. Packaging unit 10 pcs.	125100A	125101A	125150A	-	125110A
FUNCTIONALITY	MULTIFUNCTION	MULTIFUNCTION	MULTIFUNCTION	2-TIME MULTIFUNCTION	ON DELAY
E On delay	■	■	■		■
R Off delay	■	■	■		
Es On delay with control contact	■	■			
Wu Single shot leading edge, voltage-controlled	■		■		
EWu ON delay single shot leading edge, voltage-controlled		■			
Ws Single shot leading edge with control contact	■	■			
Wa Single shot trailing edge with control contact	■	■			
Bi Flasher pulse first	■	■			
Bp Flasher pause first	■	■	■		
Wt Pulse repetition analysis	■	■			
Ec Additive ON Delay	■	■			
li Asymmetric flasher pulse first				■	
lp Asymmetric flasher pause first				■	
SUPPLY CIRCUIT					
Supply voltage AC/DC	12 to 240V	12 to 240V	24 to 240V	12 to 240V	12 to 240V
Frequency range			48 - 63 Hz		
TIME CIRCUITS					
Time ranges			10		
Setting range			0.05 s - 100 h		
INPUT CIRCUIT					
Control signal	■	■	■	■	
OUTPUT CIRCUIT					
Anzahl der Schaltkontakte			1 CO contact		
Max. Schaltleistung			2000VA (8A / 250V AC)		
DESIGN					
Dimensions (w x h x d)			22.5 x 67 x 76 mm		
Certificates			CE, cULus		

TYPE DESIGNATION	V2ZR10	V2ZA10	V2ZS20	V2ZS20-E	D6DET
					
ORDER INFORMATION					
Art. No. Screw terminal	125120	125500	125300	125302	234090 (4 min) 234091 (40 min) 234092 (0.7 sec)
Art. No. Push-in terminal	125620	125510	125310	-	
Art. No. Packaging unit 10 pcs.	125120A	-	-	-	
FUNCTIONALITY	OFF DELAY	MULTIFUNKTION	STAR DELTA	STAR DELTA	2-WIRE ON DELAY
E On delay		■			
ET On delay, two wire connected					■
R Off delay	■				
A Off delay without auxiliary voltage		■			
nWu Maintained single shot leading edge		■			
nWa Maintained single shot trailing edge		■			
nWuWa Maintained single shot leading and trailing edge		■			
S Star-delta start-up			■	■	
POWER SUPPLY CIRCUIT					
Supply voltage	12 to 240V AC/DC	12 to 240V AC/DC	12 to 240V AC/DC	24V DC; 110 to 230V AC	12 to 240V AC/DC
Frequency range			48 - 63 Hz		
TIME CIRCUITS					
Time ranges	10	4	4	1	see data sheet
Setting range	0.05 s - 100 h	0.1 s - 3 min	0.05 s - 3 min	0.05 s - 1 min	
INPUT CIRCUIT					
Control signal	■				
OUTPUT CIRCUIT					
Number of switch contacts	1 CO contact	1 CO contact	2 NO contacts	2 NO contacts	1 Thyristor output
Max. switching capacity	2000VA (8A / 250V AC)	1250VA (5A / 250V AC)	750VA (3A / 250V AC)	750VA (3A / 250V AC)	125VA / 250V AC
DESIGN					
Dimensions (w x h x d)	22.5 x 67 x 76 mm	22.5 x 67 x 76 mm	22.5 x 67 x 76 mm	22.5 x 67 x 76 mm	22.5 x 64 x 75 mm
Certificates	CE, cULus	CE, cULus	CE, cULus	CE	CE

TYPE DESIGNATION	G2ZM20	G2ZMF11	G2ZI20	G2ZIF20	G2ZS20
					
ORDER INFORMATION					
Art. No. (with power module)	-	120100	-	120200	120300
Art. No. (Zoom voltage)	120401	120103	120501	120201	120301
FUNCTIONALITY	MULTIFUNCTION	MULTIFUNCTION	2-TIME MULTIFUNCTION	2-TIME MULTIFUNCTION	STAR-DELTA
E On delay	■	■			
R Off delay	■	■			
ER On delay and off delay with control contact			■	■	
Es On delay with control contact	■	■			
Wu Single shot leading edge, voltage-controlled	■	■			
Ws Single shot leading edge with control contact	■	■			
Wa Single shot trailing edge with control contact	■	■			
EWu ON delay single shot leading edge, voltage-controlled			■	■	
EWs ON delay single shot leading edge with control contact			■	■	
Wswa Single shot leading and trailing edge with control contact			■	■	
Bi Flasher pulse first	■	■			
Bp Flasher pause first	■	■			
li Asymmetric flasher pulse first			■	■	
lp Asymmetric flasher pause first			■	■	
S Star-delta start-up					■
SUPPLY CIRCUIT					
Supply voltage AC/DC	12 to 240V	24 to 240V or selectable via power modules TR2, SNT2	12 to 240V	24 to 240V or selectable via power modules TR2, SNT2	24 to 240V or selectable via power modules TR2, SNT2
Frequency range	48 – 63 Hz				
TIME CIRCUITS					
Time ranges	7	16	7	10	4
Setting range	0.05 s – 100 h	0.05 s – 30 d	0.05 s – 100 h	0.05 s – 10 h	0.05 s – 3 min
INPUT CIRCUIT					
Control signal	■	■	■	■	
Remote potentiometer		■		■	
OUTPUT CIRCUIT					
Number of switch contacts	2 CO contacts	1 delayed / 1 instantaneous CO contact	2 CO contacts	2 CO contacts	2 CO contacts
Max. switching capacity	1250VA (5A / 250V AC)				
DESIGN					
Dimensions (w x h x d)	22.5 x 90 x 108 mm				
Certificates	CE, cULus, GOST				

Please refer to page 17 for detailed information and ordering data of remote potentiometer and to page 30 for detailed information and ordering data of power modules TR2, TR3 and SNT2

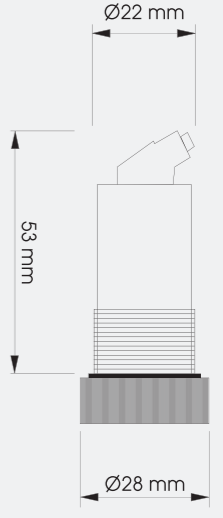
TYPE DESIGNATION	K3ZM20 K3ZM20P	K3ZA20 3MIN	K3ZI20	K3ZS20	R2 1MΩ (0.1)	R2 1MΩ (0.3)	
							
ORDER INFORMATION					ACCESSORIES FOR TIMERS		
Art. No.	135100 135200	135400	135101	135300	282130	282133	
FUNCTIONALITY	MULTIFUNCTION	MULTIFUNCTION	2-TIME MULTIFUNCTION	STAR-DELTA	REMOTE POTENTIOMETER		
E On delay	■	■			Remote potentiometer for front panel mounting. With the remote potentiometer time values can be adjusted from a distance.		
R Off delay	■				 <p>Ø22 mm 53 mm Ø28 mm</p>		
ER On delay and off delay with control contact			■				
Es On delay with control contact	■						
Wu Single shot leading edge, voltage-controlled	■						
Ws Single shot leading edge with control contact	■						
Wa Single shot trailing edge with control contact	■						
nWu Maintained single shot leading edge		■					
nWa Maintained single shot trailing edge		■					
EWu ON delay single shot leading edge, voltage-controlled			■				
EWs ON delay single shot leading edge with control contact			■				
Wswa Single shot leading and trailing edge with control contact			■				
nWuWa Maintained single shot leading and trailing edge		■					
Bp Flasher pause first	■						
li Asymmetric flasher pulse first			■				
lp Asymmetric flasher pause first			■				
Wt Pulse sequence monitoring			■				
A Off delay without auxiliary voltage		■					
S Star-delta start-up				■			
SUPPLY CIRCUIT					CONNECTIONS		
Supply voltage AC/DC	12 to 240V	24 to 240V	12 to 240V	12 to 240V	1 = First 2 = Wiper 3 = Finish		
Frequency range	48 – 63 Hz						
TIME CIRCUITS					SCALE GRADUATION		
Time ranges	7	4	7	4	1	1	
Setting range	0.05 s – 100 h	0.1 s – 3 min	0.05 s – 100 h	0.05 s – 3 min	0.1 – 1	0.3 – 3	
INPUT CIRCUIT							
Control signal	■ (K3ZM20P potential free)		■				
OUTPUT CIRCUIT							
Number of switch contacts	2 CO contacts						
Max. switching capacity	2000VA (8A / 250V AC)						
DESIGN					FRONT PANEL MOUNTING		
Dimensions (w x h x d)	38 x 51 x 80 mm					Ø 22 (28) x 53 mm	
Certificates	CE						



Function overview monitoring relays





	O	OVER	If the measured value exceeds the adjusted MAX threshold, the output relay switches into off-position. The output relay switches into on-position again, as soon as the measured value falls below the adjusted MIN threshold.
	U	UNDER	If the measured value falls below the adjusted MIN threshold, the output relay switches into off-position. The output relay switches into on-position again, as soon as the measured value exceeds the adjusted MAX threshold.
	W	WINDOW	If the measured value falls below the adjusted MIN threshold, the output relay switches into off-position. The output relay switches into on-position again, as soon as the measured value exceeds the adjusted MIN threshold. If the measured value exceeds the adjusted MAX threshold, the output relay switches into off-position. The output relay switches into on-position again, as soon as the measured value falls below the adjusted MAX threshold.
	2MIN	MINIMUM MONITORING	If the measured value falls below the adjusted MAX threshold, the output relay Rel1 switches into off-position. If the measured value falls below the adjusted MIN threshold, the output relay Rel2 switches into off-position. The output relays Rel1 and Rel2 switch into on-position again, as soon as the measured value exceeds the according adjusted threshold (MAX or MIN).
	2MAX	MAXIMUM MONITORING	If the measured value exceeds the adjusted MIN threshold, the output relay Rel2 switches into off-position. If the measured value exceeds the adjusted MAX threshold, the output relay Rel1 switches into off-position. The output relays Rel1 and Rel2 switch into on-position again, as soon as the measured value falls below the according adjusted threshold (MAX or MIN).
	MM	MINIMUM AND MAXIMUM MONITORING (MIN/MAX)	If the measured value falls below the adjusted MIN threshold, the output relay Rel2 switches into off-position. The output relay Rel2 switches into on-position again, as soon as the measured value exceeds the adjusted MIN threshold. If the measured value exceeds the adjusted MAX threshold, the output relay Rel1 switches into off-position. The output relay Rel1 switches into on-position again, as soon as the measured value exceeds the adjusted MIN threshold.
		PUMP UP	Connection of the probe rods E1, E2 and E3. When the air-fluid level falls below the minimum probe E2 the set interval of tripping delay begins. After the expiration of the interval, the output relay R switches into on-position. When the air-fluid level again rises above the maximum probe E1, the set interval of turn-off delay begins. After the expiration of the interval the output relay switches into off-position.
		PUMP DOWN	Connection of the probe rods E1, E2 and E3. When the maximum probe E1 gets moistened the set interval of tripping delay begins. After the expiration of the interval the output relay R switches into on-position. When the airfluid level falls below the minimum probe E2, the set interval of turn-off delay begins. After the expiration of the interval, the output relay switches into off-position.
	TEMP.	TEMPERATURE MONITORING	If the supply voltage U is applied and the cumulative resistance of the PTC-circuit is less than 3.6kΩ (standard temperature of the motor), the output relay R switches into on-position. When the cumulative resistance of the PTC-circuit exceeds 3.6kΩ, the output relay switches into off-position. The output relay switches into on-position again after the cumulative resistance falls below 1.6kΩ.
	L	LATCH (ERROR MEMORY)	If the device detects a fault, the output relay only switches on again when the fault latch has been reset. The fault latch can be reset by means of an internal or external reset button or by interrupting the supply voltage.
		DELAY	If the monitored value leaves the selected range, the output relay only switches into off-position following expiry of the trip delay.
		ON DELAY	The output relay switches on if the monitored value is within the selected range during the defined time period.
		START-UP SUPPRESSION	The output relay switches on when the supply voltage is applied. Changes to measured variables have no impact on the setting of the output relay during start up suppression.

TYPE DESIGNATION	K3PF400VSY02	K3YM400VSY20	K3IM5AACL20	K3UM230VAC02	K3UM24VDC02
ORDER INFORMATION					
Art. No.	1380301	1380402	1380202	1380106	1380107
FUNCTIONALITY	3-phase AC voltage monitoring	3- and 1-phase AC voltage monitoring	1-phase AC current monitoring	1-phase AC voltage monitoring	1-phase AC voltage monitoring
O ... Over			■		
U ... Under		■	■	■	■
W ... Window		■	■	■	■
SEQ ... Phase sequence	■	■			
Phase failure	■				
ASYM ... Asymmetry	■	■			
+LATCH ... Error memory			■		
SWITCHING THRESHOLD					
Maximum	-	80 to 130% of U _N	10 to 100% of U _N	80 to 120% of U _N	80 to 130% of U _N
Minimum	-	70 to 120% of U _N	5 to 95% of U _N	70 to 110% of U _N	75 to 125% of U _N
Asymmetry	5 to 30%, OFF	5 to 30%, OFF	-	-	-
MEASURING CIRCUIT					
Measuring variable	3(N)-AC Sinus	3(N)-AC Sinus	Current AC Sinus	Voltage AC AC Sinus	Voltage AC AC Sinus
Measuring input	U _N = 400/230V AC	U _N = 400/230V AC	5A AC	U _N = 230V AC	U _N = 24V DC
SUPPLY CIRCUIT					
Supply voltage	= Measuring voltage 3(N)- 400/230V AC -30% to +30%	= Measuring voltage 3(N)- 400/230V AC -30% to +30%	230V AC -15% to +10%	= Measuring voltage 3(N)- 400/230V AC -30% to +20%	= Measuring voltage 24V DC -25% to +30%
Frequency range	48 - 63 Hz	48 - 63 Hz	48 - 63 Hz	48 - 63 Hz	-
TIME CIRCUITS					
Start-up suppression time (START)	-	-	0 - 10 s	-	-
Tripping delay (DELAY)	fixed, approx. 100 ms	0.1 - 10 s	0.1 - 10 s	-	-
OUTPUT CIRCUIT					
Number of switch contacts	2 CO contacts				
Max. switching capacity	1250VA (5A / 250V AC)				
DESIGN					
Dimensions (w x h x d)	38 x 51 x 80 mm				
Certificates	CE				





THIS IS A SMALL OVERVIEW OF OUR PRODUCTS FOR THE ENTIRE PRODUCT RANGE PLEASE VISIT

www.tele-online.com

TYPE DESIGNATION	E1PF400VSY01	E1PF400VS01	E1PF480Y/277VSY01	E1YF400V01	E3YF400V02
					
ORDER INFORMATION					
Art. No. single package	1340300	-	1340306	1340402 (0.85) 1340403 (0.70)	1341401
Art. No. package 10 pcs.	1340300A	1340301A	-	1340402A (0.85)	-
FUNCTIONALITY	3-phase AC voltage monitoring				
U ... Under				■	■
W ... Window					
SEQ ... Phase sequence	■	■	■		
Phase failure	■	■	■		
ASYM ... Asymmetry	■		■		
SWITCHING THRESHOLD					
Minimum	-	-	-	fixed, 195.5V (0.85) fixed, 161V (0.70)	fixed, 195.5V
Asymmetry	5 to 25%, OFF	5 to 25%, OFF	5 to 25%, OFF	-	-
MEASURING CIRCUIT					
Measuring variable	3(N)- AC Sinus	3(N)- AC Sinus	3- AC Sinus	3(N)- AC Sinus	3(N)- AC Sinus
Measuring input	U _N = 400/230V AC	U _N = 400/230V AC	U _N = 208/120V to 480/277V AC	U _N = 400/230V AC	U _N = 400/230V AC
SUPPLY CIRCUIT					
Supply voltage	= Measuring voltage 3(N)- 400/230V AC -30% to +30%	= Measuring voltage 3(N)- 400/230V AC -30% to +30%	= Measuring voltage 3- 208/120V to 480/277V AC -10% to +10%	= Measuring voltage 3(N)- 400/230V AC -30% to +30%	= Measuring voltage 3(N)- 400/230V AC -30% to +30%
Frequency range	48 - 63 Hz				
TIME CIRCUITS					
Tripping delay (DELAY)	fixed, approx. 100ms	fixed, approx. 100ms	fixed, approx. 100ms	fixed, approx. 200ms	fixed, approx. 200ms
OUTPUT CIRCUIT					
Number of switch contacts	1 CO contact	1 CO contact	1 CO contact	1 CO contact	2 CO contacts
Max. switching capacity	1250VA (5A / 250V AC)				
DESIGN					
Dimensions (w x h x d)	17.5 x 87 x 65 mm	17.5 x 87 x 65 mm	17.5 x 87 x 65 mm	17.5 x 87 x 65 mm	35 x 87 x 65 mm
Certificates	CE, GOST	CE, GOST	CE, cULus, GOST	CE, GOST	CE, cULus, GOST

TYPE DESIGNATION	E1YM400VS10	E3YM230VS20	E1UM230V01	E1IM10AACL10 230VAC	E3LM10 230VAC
					
ORDER INFORMATION					
Art. No. single package	1340405	1341406	1340101	1340200	1341500
FUNCTIONALITY	3- and 1-phase AC voltage monitoring	3- and 1-phase AC voltage monitoring	1-phase AC/DC voltage monitoring	1-phase AC current monitoring	Level monitoring of conductive liquids
O ... Over				■	
U ... Under	■	■	■	■	
W ... Window	■	■	■	■	
SEQ ... Phase sequence	■	■			
Phase failure		■			
Pump up					■
Pump down					■
SWITCHING THRESHOLD					
Maximum	80 to 130% of U _N	80 to 130% of U _N	80 to 120% of U _N	10 to 100% of U _N	-
Minimum	70 to 120% of U _N	70 to 120% of U _N	75 to 115% of U _N	5 to 95% of U _N	-
Asymmetry	5 to 25%, OFF	-	-	-	-
MEASURING CIRCUIT					
Measuring variable	3(N)- AC Sinus	3(N)- AC Sinus	Voltage AC/DC AC Sinus	Current AC Sinus	Liquid level via conductive probes
Measuring input	U _N = 400/230V AC	U _N = 230/132V AC	24V AC/DC; 230V AC	10A AC	0.25 to 100kΩ
SUPPLY CIRCUIT					
Supply voltage	= Measuring voltage 3(N)- 400/230V AC -30% to +30%	= Measuring voltage 3(N)- 400/230V AC -30% to +30%	= Measuring voltage 3(N)- 400/230V AC -25% to +20%	230V AC -15% to +15%	230V AC -15% to +10%
Frequency range	48 - 63 Hz	48 - 63 Hz	48 - 63 Hz or DC	48 - 63 Hz	48 - 63 Hz
TIME CIRCUITS					
Tripping delay (DELAY)	0.1 - 10 s	0 - 30 s	-	0.1 - 10 s	0.5 - 10 s
OFF DELAY	-	-	-	-	0.5 - 10 s
OUTPUT CIRCUIT					
Number of switch contacts	1 CO contact	2 CO contacts	1 CO contact	1 CO contact	1 CO contact
Max. switching capacity	1250VA (5A / 250V AC)				
DESIGN					
Dimensions (w x h x d)	17.5 x 87 x 65 mm	35 x 87 x 65 mm	17.5 x 87 x 65 mm	17.5 x 87 x 65 mm	35 x 87 x 65 mm
Certificates	CE, GOST	CE, GOST	CE, cULus, GOST	CE, cULus, GOST	CE, cULus, GOST

TYPE DESIGNATION	V2PF480Y/277VSY01	V2PM400Y/230VS10	V2UM230V10	V4PF480Y/277VSYTK02
				
ORDER INFORMATION				
Art. No. screw terminal	2100000	2100500	2100300	2104200
Art. No. push-in terminal	2100010	2100510	2100310	2104210
Art. No. package 10 pcs.	2100000A	-	-	-
FUNCTIONALITY	3- phase AC voltage monitoring	3- phase AC voltage monitoring	1- phase AC/DC voltage monitoring	3- phase AC voltage monitoring
O ... Over				
U ... Under		■	■	
W ... Window		■	■	
SEQ ... Phase sequence	■	■		■
Phase failure	■	■		■
ASYM ... Asymmetrie	■			■
Temperature monitoring (PTC)				■
SWITCHING THRESHOLD				
Maximum	-	75 to 130% of U_N	80 to 115% of U_N	-
Minimum	-	70 to 125% of U_N	75 to 110% of U_N	-
Asymmetry	5 to 25%, OFF	-	-	5 to 25%, OFF
MEASURING CIRCUIT				
Measuring variable	3- AC Sinus	3- AC Sinus	Voltage AC/DC AC Sinus	Temperature, Voltage 3- AC Sinus
Measuring input	$U_N = 208/120V$ to 480/277V AC	$U_N = 400/230V$ AC	24V AC/DC; 230V AC	$U_N = 208/120V$ to 480/277V AC
SUPPLY CIRCUIT				
Supply voltage	= Measuring voltage 3- 208/120V to 480/277V AC -10% to +10%	= Measuring voltage 3(N)- 400/230V AC -35% to +35%	= Measuring voltage 24V AC/DC; 230V AC 24V: -30% to +30% 230V: -30% to +20%	= Measuring voltage 3- 208/120V to 480/277V AC -10% to +10%
Frequency range	48 - 63 Hz	16.6 - 400 Hz	16.6 - 400 Hz or DC	48 - 63 Hz
TIME CIRCUITS				
ON DELAY	approx. 400 ms	approx. 200 ms	approx. 300 ms	approx. 500 ms
Tripping delay (DELAY)	< 250 ms	0.1 - 10 s	0.1 - 10 s	approx. 250 ms
OUTPUT CIRCUIT				
Number of switch contacts	1 CO contact	1 CO contact	1 CO contact	2 CO contacts
Max. switching capacity	2000VA (8A / 250V AC)			
DESIGN				
Dimensions (w x h x d)	22.5 x 67 x 76 mm	22.5 x 67 x 76 mm	22.5 x 67 x 76 mm	45 x 67 x 76 mm
Certificates	CE, cULus			

TYPE DESIGNATION	V2IM10AL10	V4IM100AL20	V4IM35AL20	V2TF01	V2TF01-E
					
ORDER INFORMATION					
Art. No. screw terminal	2100400	2104401	2104402	2100100	2100101
Art. No. push-in terminal	2100410	2404410	-	2100110	-
FUNCTIONALITY	1-phase AC/DC current monitoring	1-phase AC/DC current monitoring	1-phase AC/DC current monitoring	Temperature monitoring (PTC)	Temperature monitoring (PTC)
O ... Over	■	■	■		
U ... Under	■	■	■		
W ... Window	■	■	■		
2MAX ... Maximum monitoring		■	■		
MM ... Minimum and maximum monitoring		■	■		
+LATCH ... Error memory		■	■		
Temperature monitoring (PTC)				■	■
Short circuit monitoring (PTC)				■	■
SWITCHING THRESHOLD					
Maximum	10 to 100% of I_N	10 to 100% of I_N	10 to 100% of I_N	$\geq 3.6k\Omega$ (switch-off resistance)	$\geq 3.6k\Omega$ (switch-off resistance)
Minimum	5 to 95% of I_N	5 to 95% of I_N	5 to 95% of I_N	$\leq 1.6k\Omega$ (switch-on resistance)	$\leq 1.6k\Omega$ (switch-on resistance)
MEASURING CIRCUIT					
Measuring variable	Current AC/DC AC Sinus	Current AC/DC AC Sinus	Current AC/DC AC Sinus	Temperature	Temperature
Measuring input	10A AC/DC	100A AC/DC Built-in current transformer	35A AC/DC Built-in current transformer	-	-
SUPPLY CIRCUIT					
Supply voltage	AC: 110 - 240V DC: 24 - 240V AC: -15% to +15% DC: -30% to +30%	24 - 240V AC/DC AC: -15% to +10% DC: -30% to +30%	24 - 240V AC/DC AC: -15% to +10% DC: -30% to +30%	24 - 240V AC/DC -15% to +10%	230V AC -15% to +15%
Frequency range	16.6 to 400Hz or DC	16.6 to 400Hz or DC	16.6 to 400Hz or DC	16.6 to 400Hz or DC	48 - 63 Hz
TIME CIRCUITS					
ON DELAY	approx. 300 ms	approx. 300 ms	approx. 300 ms	approx. 50 ms	approx. 50 ms
Start-up suppression time (START)	-	0 - 10 s	0 - 10 s	-	-
Tripping delay (DELAY)	0.1 - 10 s	0.1 - 10 s	0.1 - 10 s	-	-
OUTPUT CIRCUIT					
Number of switch contacts	1 CO contact	2 CO contacts	2 CO contacts	1 NO contact	1 NO contact
Max. switching capacity	2000VA (8A / 250V AC)	2000VA (8A / 250V AC)	2000VA (8A / 250V AC)	2000VA (8A / 250V AC)	1250VA (5A / 250V AC)
DESIGN					
Dimensions (w x h x d)	22.5 x 67 x 76 mm	45 x 67 x 76 mm	45 x 67 x 76 mm	22.5 x 67 x 76 mm	22.5 x 67 x 76 mm
Certificates	CE, cULus	CE, cULus	CE, cULus	CE, cULus	CE

TYPE DESIGNATION	G2PF400VS02	G2PM400VSY10 G2PM400VSY20	G2TF01 G2TF02	G2TFKN02	G2LM20
					
ORDER INFORMATION					
Art. No. 1 CO contact	-	2390500	2390102 (230V AC) 2390103	-	-
Art. No. 2 CO contacts	2390000	2390504 2390505	2390100 2390104 (230V AC) 2390111	2390101 2390110	2390201 (24V AC) 2390202 (110V AC) 2390200 (230V AC)
FUNCTIONALITY	3 - phase AC voltage monitoring	3 - phase AC voltage monitoring	Temperature monitoring (PTC)	Temperature monitoring (PTC)	Level monitoring of conductive liquids
U ... Under		■			
W ... Window		■			
SEQ ... Phase sequence		■			
Phase failure	■	■			
ASYM ... Asymmetry	■	■			
Temperature monitoring (PTC)			■	■	
Short circuit monitoring (PTC)				■	
Zero-voltage latch (PTC)				■	
Test function (PTC)			■	■	
Pump up					■
Pump down					■
SWITCHING THRESHOLD					
Maximum	-	-20 to +30% of U _N	≥ 3.6kΩ (switch-off resistance)	≥ 3.6kΩ (switch-off resistance)	-
Minimum	-	-30 to +20% of U _N	≤ 1.6kΩ (switch-on resistance)	≤ 1.6kΩ (switch-on resistance)	-
Asymmetry	fixed, typ. 30%	5 to 25%, OFF	-	-	-
MEASURING CIRCUIT					
Measuring variable	3(N)-AC Sinus	3(N)-AC Sinus	Temperature	Temperature	Liquid level via conductive probes
Measuring input	U _N = 400/230V AC	3(N)- 400/230V	-	-	0.25 to 100kΩ
SUPPLY CIRCUIT					
Supply voltage	= Measuring voltage 3(N)- 342V to 457V AC	24 to 240V AC/DC or selectable via power modules TR2, SNT2	24 to 240V AC/DC; 230V fixed or selectable via power modules TR2, SNT2	24 to 240V AC/DC or selectable via power modules TR2, SNT2	24V AC 110V AC 230V AC
TIME CIRCUITS					
Start-up suppression time (START)	fixed, max. 500ms	-	-	-	-
Tripping delay (DELAY)	fixed, max. 350ms	0.1 - 10 s	-	-	0.5 - 10 s
OFF DELAY	-	-	-	-	0.5 - 10 s
OUTPUT CIRCUIT					
Number of switch contacts	2 CO contacts	1 or 2 CO contacts	1 or 2 CO contacts	2 CO contacts	2 CO contacts
Max. switching capacity	1250VA (5A / 250V AC)				
DESIGN					
Dimensions (w x h x d)	22.5 x 90 x 108 mm				
Certificates	CE, cULus, GOST				
Please refer to page 30 for detailed information and ordering data of power modules TR2, TR3 and SNT2					

TYPE DESIGNATION	G2PU690VS20	G2UM300VL20	G2IM5AL10 G2IM5AL20	G2IM10AL10 G2IM10AL20	G2FW400VL20
					
ORDER INFORMATION					
Art. No. 1 CO contact	-	-	2390401	2390400	-
Art. No. 2 CO contacts	2390507	2390303 2390304	2390405 2390411	2390406 2390410	2390900
FUNCTIONALITY	3- phase AC voltage monitoring	1- phase AC/DC voltage monitoring	1- phase AC/DC current monitoring	1- phase AC/DC current monitoring	Frequency monitoring
O ... Over		■	■	■	
U ... Under	■	■	■	■	
W ... Window		■	■	■	■
SEQ ... Phase sequence	■				
Phase failure	■				
ASYM ... Asymmetry	■				
+LATCH ... Error memory		■	■	■	■
SWITCHING THRESHOLD					
Maximum	-	10 to 100% of U _N	10 to 100% of I _N	10 to 100% of I _N	F _N = 50Hz: 49 to 60Hz F _N = 60Hz: 59 to 70Hz
Minimum	180 to 690V	5 to 95% of U _N	5 to 95% of I _N	5 to 95% of I _N	F _N = 50Hz: 40 to 51Hz F _N = 60Hz: 50 to 61Hz
Asymmetry	fixed, 25%	-	-	-	-
MEASURING CIRCUIT					
Measuring variable	3~ AC Sinus	Voltage AC/DC AC Sinus	Current AC/DC AC Sinus	Current AC/DC AC Sinus	Frequency, 1-phase
Measuring input	U _N = 208V bis 690V	30 / 60 / 300V AC/DC	20mA / 1A / 5A AC/DC	100mA / 1A / 10A AC/DC	110 - 400V AC
SUPPLY CIRCUIT					
Supply voltage	= Measuring voltage 3~ 177V to 794V	24 to 240V AC/DC or selectable via power modules TR2, SNT2	24 to 240V AC/DC or selectable via power modules TR2, SNT2	24 to 240V AC/DC or selectable via power modules TR2, SNT2	24 to 240V AC/DC
TIME CIRCUITS					
ON DELAY	-	-	-	-	0 - 10 s
Start-up suppression time (START)	-	0 - 10 s	0 - 10 s	0 - 10 s	-
Tripping delay (DELAY)	0.1 - 10 s	0.1 - 10 s	0.1 - 10 s	0.1 - 10 s	0.1 - 10 s
OUTPUT CIRCUIT					
Number of switch contacts	2 CO contacts	2 CO contacts	1 or 2 CO contacts	1 or 2 CO contacts	2 CO contacts
Max. switching capacity	1250VA (5A / 250V AC)				
DESIGN					
Dimensions (w x h x d)	22.5 x 90 x 108 mm				
Certificates	CE, cULus, GOST				
Please refer to page 30 for detailed information and ordering data of power modules TR2, TR3 and SNT2					

Load monitors



Monitoring of electronic motors

TELE load monitoring systems offer significant advantages, particularly in situations in which monitoring tasks are usually carried out by sensors:

- No problems due to contamination and any decalibration of the sensors
- No maintenance and cleaning costs
- Easy to use, even in charged air or volatile substances
- Savings in terms of cabling
- No use of explosion-proof barriers necessary
- Reduction in error sources
- Simple retrofitting

Current monitoring relays

Pure current measurements in the supply to motors can only be used in an extremely restricted capacity to monitor loads. This is due to three essential factors:

- 1) In alternating current circuits, the measured current is apparent current. This total current comprises the sum of reactive and active current components. However, when generating mechanical power it is the active current that is exclusively decisive. The reactive current merely causes losses and does not contribute to the shaft power delivered.
- 2) In an underload range the current does not reduce in a linear manner with the load but instead remains relatively high due to the necessary magnetisation current. Therefore, no relevant correlation exists between current and load.
- 3) The current is dependent on the supply voltage. An undervoltage condition with a constant load can result in an increased current draw. This therefore eliminates monitoring the pure active current too.

Thus, monitoring pure current is only applicable in extreme operating conditions, such as a drive blockage, because the current rises dramatically in such cases.

Load monitoring systems with power factor measurement (cos φ)

The power factor $\cos \varphi$ is the cosine of the phase shift angle between the current drawn and the voltage applied. In electrical motors this is dependent on the loading and theoretically equals 1 in an ideal case. However, due to induction it effectively lies within a range of 0.85 to 0.95 with a nominal load.

In an underload range, the $\cos \varphi$ monitor is extremely significant because the proportion of losses at a lower load increases dramatically and results in a $\cos \varphi$ of up to <0.5 in an idle state. This is not applicable around the zero point and in an overload range because load changes only result in minimal changes to the phase shift angle φ .

Load monitoring systems with effective power measurements

The effective power measurement facilitates obtaining the most precise feedback regarding the state of an electrical motor because the effective power is proportional to the shaft power. A direct correlation exists between the effective power supplied and the motor loading (torque with constant rotational speed) across the entire working range.

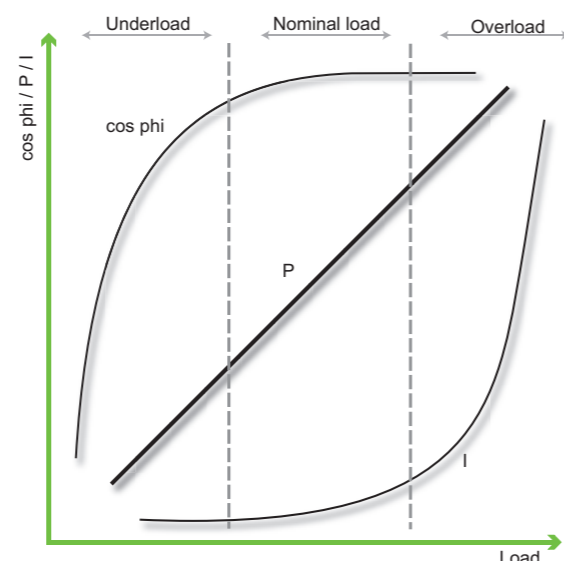

Examples for Load Monitor-Usage:

- **Trash Compactor:** Under- and overload monitoring of motor drives of screw compactor or hydraulic pumps and control of refilling.
- **Crusher:** Under- and overload monitoring of motor drives and control of refilling.
- **Mixers:** Under- and overload monitoring of motor drives.
- **Conveyor belts:** Under- and overload monitoring of motor drives of conveyor belts and control of refilling.
- **Ventilation systems:** Under- and overload monitoring of motor drives of ventilators.
- **Machine tools:** Under- and overload monitoring of motor drives of machining tools, coolant pumps, swarf conveyors and control option of feed unit.
- **Bridge and portal cranes:** Overload monitoring of hoist motors.
- **Centrifugal and piston pumps:** Under- and overload monitoring of pump motors and control of flow rate.

TYPE DESIGNATION	G2CM400V10AL20	G2BA400V12A 4-20mA G2BA400V12A 0-10V	G2BM400V12AL10 G2BM400V12AFL10	G4BM690V16AL20	G4BM480V12ADTL20
Art. No.	2390602	2390705 2390708	2390700 2390702	2394721	2394706
FUNCTIONALITY	COS φ power factor in 1- or 3-phase mains	Active power transducer in 1- or 3-phase mains	True power monitoring in 1- or 3-phase mains	True power monitoring in 1- or 3-phase mains	True power monitoring in 1- or 3-phase mains
O ... Overload monitoring	■		■		■
U ... Underload monitoring	■		■		■
W ... Window	■				■
2MIN ... Minimum monitoring				■	■
2MAX ... Maximum monitoring				■	■
MIN/MAX ... Minimum- and maximum monitoring				■	■
+LATCH ... Error memory	■		■	■	■
I = 0 DETECTION ... Recognition of disconnected consumers			■	■	■
Temp ... Temperature monitoring of the motor winding			■	■	■
SWITCHING THRESHOLD					
Zero ... Zero point	-	0%, 25%, 50% and 75% of nominal value	-	-	-
Zero Fine ... Fine setting zero point	-	0 - 25% of nominal value	-	-	-
Span ... Measuring span	-	100%, 75%, 50% and 25% of nominal value	-	-	-
Threshold P / P1	cos φ Max: 0.2 - 1.0	-	5 to 120% of P _N	10 to 120% of P _N	2.5kW: 120W to 2490W 10kW: 480W to 9960W
Threshold P2	cos φ Min: 0.1 - 0.99	-	-	5 to 110% of P _N	-
MEASURING CIRCUIT					
Measuring variable	Power factor (cos φ), 1- or 3-phase loads AC Sinus	True power, 1- or 3-phase loads AC Sinus	True power, 1- or 3-phase loads AC Sinus	True power, 1- or 3-phase loads AC Sinus	True power, 1- or 3-phase loads AC Sinus
Measuring range	0.1 to 1	0.75kW • 1.5kW • 3kW • 6kW	0.5kW • 1kW • 2kW • 4kW	2kW • 4kW • 8kW • 16kW	2.5kW • 10kW
Measuring input voltage	40 to 415V AC (single-phase) 40/23 to 415/240V (3 ~)	0 to 480V AC (single-phase) 0 to 480/277V (3 ~)	0 to 230V AC (single-phase) 0 to 415/240V (3 ~)	42 to 690V AC (single-phase) 42 to 690/400V (3 ~)	0 to 480V AC (single-phase) 0 to 480/277V (3 ~)
Overload capacity voltage	500V AC (single-phase) 500/289V (3 ~)	550V AC (single-phase) 550/318V (3 ~)	300V AC (single-phase) 500/289V (3 ~)	796V AC (single-phase) 796/460V (3 ~)	550V AC (single-phase) 550/318V (3 ~)
Measuring input current	0.5 to 10A	0 to 6A (0.6 and 1.2kW) 0 to 12A (2.4 and 4.8kW)	0 to 6A (0.5 and 1kW) 0 to 12A (2 and 4kW)	0.2 to 8A (2 and 4kW) 0.4 to 16A (8 and 16kW)	0.15 to 6A (2.5kW) 0.3 to 12A (10kW)
Overload capacity current	11 A permanent	12 A permanent	12 A permanent	18 A permanent	12 A permanent
SUPPLY CIRCUIT					
Supply voltage	Selectable via power module TR2	24 - 240V DC; 48 - 240V AC	Selectable via power module TR2	Selectable via power module TR2	24 - 240V AC/DC
TIME CIRCUITS					
Start-up suppression time (START)	1 - 100 s	-	1 - 100 s (AL10) 0.1 - 2 s (AFL10)	1 - 100 s	0 - 100 s
Tripping delay (DELAY)	0.1 - 40 s	-	0.1 - 50 s (AL10) 0.1 - 2 s (AFL10)	0.1 - 50 s	0.1 - 50 s
INPUT CIRCUIT					
Control input	-	-	Y1-Y2 (Latch)	Y1-Y2 (Latch)	Y1-Y2 (Latch)
OUTPUT CIRCUIT					
Analog output	-	4 - 20mA (Burden: max. 500Ω) 0-10V (Burden: min. 3kΩ)	-	-	-
Number of switch contacts	2 CO contacts	-	1 CO contact	2 CO contacts	2 CO contacts
Max. switching capacity	1250VA (5A / 250V AC)	-	1250VA (5A / 250V AC)	1250VA (5A / 250V AC)	1250VA (5A / 250V AC)
DESIGN					
Dimensions (w x h x d)	22.5 x 90 x 108 mm	22.5 x 90 x 108 mm	22.5 x 90 x 108 mm	45 x 90 x 108 mm	45 x 90 x 125 mm
Certificates	CE, cULus, GOST	CE, GOST	CE, cULus, GOST	CE, cULus, GOST	CE, cULus, GOST

Please refer to page 30 for detailed information and ordering data of power modules TR2 and TR3

Grid and system protection



Autonomously working disconnecting point for private small power plants

Why? If mains power is disconnected or suffers an outage, private small-scale power plants need to be disconnected from the grid immediately to prevent injuries and damage to their equipment.

Function: An automatic control station monitors the energy feedback into the 230/400 V grid. If mains power is switched off by the electricity supply company, or by a protective device, it is vital for small-scale power plants to be disconnected within a few milliseconds. Monitoring the voltage and frequency and recognizing isolated (off-grid) operation are essential requirements for any automatic control station.

Requirement: The conversion of renewable energy into electrical energy is an important element in stabilizing the world's climate. The principal small and micro-scale power plants used are photovoltaic installations, small-scale wind power generators, block heating and generating plants or small-scale hydroelectric generators.

The operator's energy yields may be used to meet his own needs or – increasingly – profitably fed back into the public low-voltage grid. To ensure the safety of the power grid the transition between private small-scale power plants and the electricity supply company is monitored by an automatic control station.

Large power stations are controlled and monitored directly from the electricity supply company using telecontrol technology, but this is too elaborate for the many private electricity generators and would not be economical.

If the electricity supply company's mains power grid suffers an outage or malfunction, then private small-scale power plants need to be disconnected from the low-voltage grid immediately to prevent power being inadvertently fed into the public grid. This is where TELE products come into play.

Immediate isolation from the grid is the only way of ensuring that maintenance personnel are not endangered and that consumers do not suffer injury or damage from excessively fluctuating voltage or frequency. Monitoring and automatic isolation are handled by an automatic control station. Details of the implementation and testing of such automatic control stations are specified in various national standards. TELE offers a whole range of grid monitoring relays and isolation

stations that fulfil these standards as well as the electricity supply companies' requirements. If the grid operator requires it, the thresholds used can be adjusted to fall within the values prescribed by the standard. Failsafe devices fulfil their monitoring function even in a fault situation, recognizing the problem and making the equipment safe.

Specific national standards: TELE's wide range of products offers an optimal solution for any country and any requirement. Apart from special devices for the German and Austrian market (VDE-AR-N-4105, ÖNorm E8001-4-712/A1) there are also specific national solutions for Italy, France and more.



Wind power plant



Hydropower station



Combined heat and power plant



Biomass power plant



Photovoltaic

TELE solutions offer:

- Functional safety
- Voltage drop protection
- Over voltage protection
- Monitoring of voltage quality
- Frequency drop protection
- Frequency rise protection
- Detection of off-grid operation

TYPE DESIGNATION	G4PF33-1	G4PF21-1	G2VFR2013	G2FW50HZYFA02
Certification / Standard	VDE-AR-N 4105	CEI 0-21	VDE V 0126-1-1 VFR2013	VDE V 0126-1-1
Country	Germany and others	Italy	France	Greece and others
Measurement parameter	Voltage 3-phase AC, frequency			
Art. No.	2394512	24V DC: 2394516 230V AC: 2394513 400V AC: 2394514	2390913	2390910
Certificate of conformity	■	■		
FUNCTIONS				
Voltage monitoring	Voltage fall & rise voltage protection			
Frequency monitoring	Frequency fall & rise protection			
Fault latch	■	■		
Passive islanding	■			
Detection	60 s – 10 min	0 – 300 s	fixed, 30 s	fixed, 30 s
On-delay	see datasheet			
Off-delay	■			
Single fault tolerance				
Digital user interface including password protection	■	■		
SUPPLY CIRCUIT				
Supply voltage	230V AC	24V DC, 230V AC, 400V AC	selectable via power module TR2	
Rated frequency	50 Hz			
MEASURING CIRCUIT				
10 minute average value	110 to 115% of U_N			
Voltage monitoring Max	fixed, 115% of U_N	see datasheet	fixed, 115% of U_N	fixed, 115% of U_N
Voltage monitoring Min	fixed, 80% of U_N		fixed, 80% of U_N	fixed, 80% of U_N
Frequency monitoring Max	50.2 to 51.5 Hz		fixed, 50.4 Hz	fixed, 50.2 Hz
Frequency monitoring Min	fixed, 47.5 Hz		fixed, 47.5 Hz	fixed, 47.5 Hz
OUTPUT CIRCUIT				
Number of switch contacts	2 galvanically separated CO contacts (potential-free)		2 CO contacts (potential-free)	
Max. switching capacity	1250VA (5A /250V AC)			
DESIGN				
Dimensions (w x h x d)	45 x 90 x 125 mm	45 x 90 x 125 mm	22.5 x 90 x 108 mm	22.5 x 90 x 108 mm
Certificates	CE			
Please refer to page 30 for detailed information and ordering data of power modules TR2 and TR3				

Accessories

For our timing- and monitoring relays as well as our load monitors and grid and system protection we offer the following accessories.

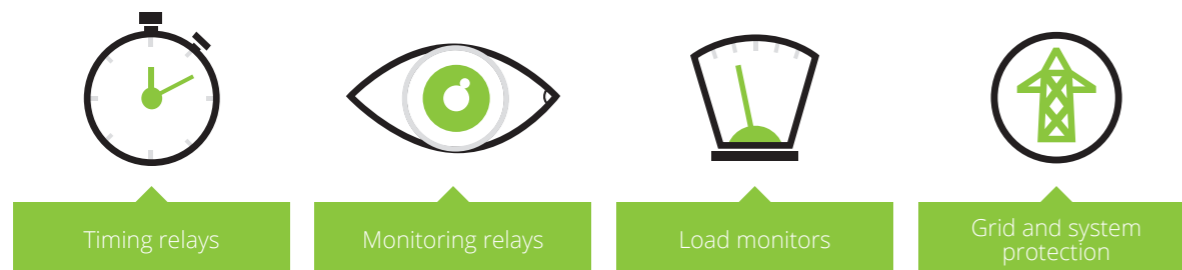

TR2, TR3, SNT series power modules and switching power supplies for transforming the supply voltage to the internal operating voltage of GAMMA relays

	TYPE DESIGNATION	SUPPLY VOLTAGE	TOLERANCE	POWER INPUT P _{in}	POWER OUTPUT P _{out}	DESIGN	ART. NO.
	SNT2 - 24V DC	24V DC	20.4 - 26.4V			A	282050
	TR2 - 12V AC	12V AC	10.2 - 13.2V	2VA	0.5VA	A	282121
	TR3 - 12V AC	12V AC	10.2 - 13.2V	4VA	1.5VA	B	285021
	TR2 - 24V AC	24V AC	20.2 - 26.4V	2VA	0.5VA	A	282110
	TR3 - 24V AC	24V AC	20.4 - 26.4V	4VA	1.5VA	B	285010
	TR2 - 42V AC	42V AC	36 - 46V	2VA	0.5VA	A	282111
	TR3 - 42V AC	42V AC	36 - 46V	4VA	1.5VA	B	285011
	TR2 - 48V AC	48V AC	41 - 53V	2VA	0.5VA	A	282112
	TR3 - 48V AC	48V AC	41 - 53V	4VA	1.5VA	B	285012
	TR2 - 110V AC	110V AC	94 - 121V	2VA	0.5VA	A	282113
	TR3 - 110V AC	110V AC	94 - 121V	4VA	1.5VA	B	285013
	TR2 - 127V AC	127V AC	108 - 140V	2VA	0.5VA	A	282114
TR3 - 127V AC	127V AC	108 - 140V	4VA	1.5VA	B	285014	
	TR2 - 230V AC	230V AC	195 - 264V	2VA	0.5VA	A	282120
	TR3 - 230V AC	230V AC	184 - 264V	4VA	1.5VA	B	285025
	TR2 - 400V AC	400V AC	340 - 456V	2VA	0.5VA	A	282117
	TR3 - 400V AC	400V AC	323 - 456V	4VA	1.5VA	B	285017
	TR3 - 440V AC	440V AC	374 - 484V	4VA	1.5VA	B	285019
	TR3 - 500V AC	500V AC*	425 - 550V	4VA	1.5VA	B	285026

* may only be used in connection with types G4PM and G4BM!

Mounting plate MP

for fixing TELE devices on a mounting plate or wall

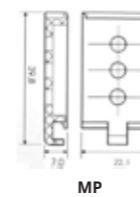

TYPE DESIGNATION	Ø DRILL HOLES	DIMENSIONS (W X H X D)	ART. NO.
MP	Ø 4 mm	22.1 x 39.8 x 7.0 mm	075474
MP GAMMA			075574

Probes - SK series

for monitoring level of conductive liquids

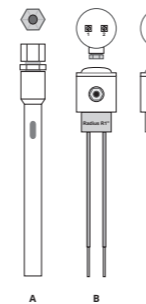

TYPE DESIGNATION	MEASURING VOLTAGE	MAX. TEMPERATURE	NUMBER OF ELECTRODES	LENGTH	DESIGN	ART. NO.
SK1	max. 24V AC	60° C	1	140 mm	A	190107
SK2		90° C	2	500 mm	B	190108
SK3-500		90° C	3	500 mm	C	190109
SK3-1000		90° C	3	1000 mm	C	190110

Front cover FA-G2

for GAMMA monitoring relays (width 22.5 mm)

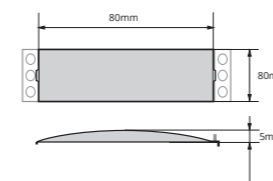

TYPE DESIGNATION	Ø DRILL HOLES	DIMENSIONS (W X H X D)	ART. NO.
FA-G2		Sealable front cover for protecting GAMMA devices against unintended or unauthorized changes in setup parameters. 22.5 x 80 x 5 mm	070160

Complementary products



In addition to our product range we also offer the following complementary products:

Signal converter	- Signalamplifier series: M1 - Loop-powered isolator series: M1	Page 33
Current transformers	- Baffle-type current transformer series: WSW - Bar-type current transformer series: DSW	Page 33
Coupling units	- Coupling relays series: ENYA - Automatic-Manual-OFF relay series: OCTO - Analogue data encoder series: OCTO - Levelswitch series: OCTO	Page 34
Switching relays Sets Accessoires	- Interface Relays series: STKR and SKR - Multifunction time modul series: COMBI - Miniature Relays series: RA and RM - Industrial Relays series: RT - PCB Relays series: RP	Page 35 Page 36
Softstarter Braking units Thyristor control units	- Softstarter series: TSG/MSG, EUROSTART and ESG - Braking units series: MBG, BG - Thyristor control units series: TST, ESGT	Page 37 Page 38 Page 39
Hour meters Digital time switches Countdown timer	- Hour meters series: TBG and TBW - Digital time switches series: TSC - Countdown timers series: TTC	Page 40
Safety relays	- Safety relays series: S ²	Page 41
DC power supplies	- Switching power supplies	Page 42

TYPE DESIGNATION	M1MTB1	M1MTN1	M1MPT100	M1MTNI
ORDER INFORMATION				
Art. No.	717002	717003	717004	717005
FUNCTIONALITY	UNIVERSAL SIGNAL AMPLIFIER	STANDARD SIGNAL AMPLIFIER	UNIVERSAL TEMPERATURE SIGNAL AMPLIFIER	LOOP-POWERED ISOLATOR
SUPPLY CIRCUIT				
Supply voltage	24 – 240V AC/DC	24 – 240V AC/DC	24 – 240V AC/DC	-
Rated frequency	48 – 62Hz	48 – 62Hz	48 – 62Hz	-
INPUT CIRCUIT				
Current input	±20mA • 0 – 20mA • 4 – 20mA ±10mA • 0 – 10mA • 2 – 10mA	0 – 20mA • 4 – 20mA	-	0(4) – 20mA / max. 30V operating current < 20 µA
Voltage input	±10V • 0 – 10V • 2 – 10V ±5V • 0 – 5V • 1 – 5V	0 – 10V	-	-
Temperature input (probe PT100 or PT1000)	-	-	2-, 3-, 4-wire • – 100°C to +700°C probe current PT100: 1mA probe current PT1000: 0.1mA	-
OUTPUT CIRCUIT				
Current output	±20mA • 0 – 20mA • 4 – 20mA ±10mA • 0 – 10mA • 2 – 10mA (output voltage: max. 12V)	0 – 20mA • 4 – 20mA (output voltage: max. 10V)	0 – 20mA • 4 – 20mA (output voltage: max. 10V)	0(4) – 20mA (output voltage: max. 28V)
Voltage output	±10V • 0 to 10V • 2 to 10V ±5V • 0 to 5V • 1 to 5V (output current: max. 10mA)	0 – 10V (output current: max. 10mA)	0 – 10V • 2 – 10V 0 – 5V • 1 – 5V (output current: max. 5mA)	-
ISOLATION				
Secure galvanic separation	up to 600V AC	-	up to 300V AC/DC	up to 600V AC/DC
Overtoltage category	II (4kV AC)	II (2.5kV AC)	II (2.5kV)	II (4kV AC)
DESIGN				
Dimensions (w x h x d)	12.5 x 99 x 111 mm			
Certificates	CE, GOST			

DSW, WSW series current transformers



WSW 60



DSW 60

TYPE DESIGNATION	RATED POWER	RATED PRIMARY CURRENT	SECONDARY CURRENT	DIMENSIONS	CLASS	ART. NO.	
WSW 60 10A/5A 2,5VA	2.5VA	10A	5A	80 x 60 x 30 mm	1	498063	
WSW 60 15A/5A 2,5VA	2.5VA	15A		80 x 60 x 30 mm		498064	
WSW 60 20A/5A 2,5VA	2.5VA	20A		80 x 60 x 30 mm		498065	
WSW 60 25A/5A 2,5VA	2.5VA	25A		80 x 60 x 30 mm		498066	
WSW 60 30A/5A 2,5VA	2.5VA	30A		80 x 60 x 30 mm		498067	
WSW 60 40A/5A 2,5VA	2.5VA	40A		80 x 60 x 30 mm		498068	
DSW 60 50A/5A 1,25VA	1.25VA	50A		50.5 x 50.5 x 85 mm		3	498069
DSW 60 60A/5A 1,25VA	1.25VA	60A		33 x 33 x 50 mm		1	498070
DSW 60 75A/5A 2,5VA	2.5VA	75A		50.5 x 50.5 x 85 mm	3	498071	
DSW 60 100A/5A 2,5VA	2.5VA	100A		33 x 33 x 50 mm	1	498073	
DSW 60 150A/5A 3,75VA	3.75VA	150A		33 x 33 x 50 mm		498075	
DSW 60 200A/5A 5VA	5VA	200A		33 x 33 x 50 mm		498076	
DSW 60 250A/5A 5VA	5VA	250A		33 x 33 x 50 mm		498077	
DSW 60 300A/5A 5VA	5VA	300A		33 x 33 x 50 mm		498078	
DSW 80 400A/5A	10VA	400A		50.5 x 50.5 x 85 mm		498081	
DSW 80 800A/5A	10VA	800A		50.5 x 50.5 x 85 mm		498084	
ACCESSORIES	DESCRIPTION					ART. NO.	
MC-SW (2 pieces)	Mounting clip required for mounting the current transformer on DIN-Rail TS 35					498100	

TYPE DESIGNATION	E1K	E3K	HAR1	OVP1	OCP1	OVL1	OCL1
							
ORDER INFORMATION							
Art. No.	110700	111700	170010	170012	170018	170015	170017
FUNCTIONALITY	COUPLING RELAYS	COUPLING RELAYS	AUTOMATIC-MANUAL-OFF RELAY	ANALOGUE DATA ENCODER	ANALOGUE DATA ENCODER	LEVELSWITCH	LEVELSWITCH
Coupling unit	■	■					
AUTO ... Automatic			■	■	■	■	■
0 ... OFF			■	■	■	■	■
HAND ... Manual			■	■	■	■	■
SUPPLY CIRCUIT							
Supply voltage	24 – 240V AC/DC	12 – 240V AC/DC	24V AC/DC	24V AC/DC	24V AC/DC	24V AC/DC	24V AC/DC
Rated frequency	48 – 63 Hz						
INPUT CIRCUIT							
Control voltage	-	-	24V AC/DC	-	-	-	-
Analogue input DC	-	-	-	0 – 10V	0 – 20mA	0 – 10V	0 – 20mA
Trigger level DC	-	-	-	0 – 10V	0 – 20mA	1 – 10V	2 – 20mA
CHECKBACK							
Number of checkback contacts	-	-	1 NO contact	1 NO contact	1 NO contact	1 NO contact	1 NO contact
Min. switching capacity	-	-	5mVA (1mA / 5V)	5mVA (1mA / 5V)	5mVA (1mA / 5V)	5mVA (1mA / 5V)	5mVA (1mA / 5V)
Max. switching capacity	-	-	24VA (500mA / 48V)	56VA (2A / 28V)	56VA (2A / 28V)	56VA (2A / 28V)	56VA (2A / 28V)
OUTPUT CIRCUIT							
Number of switching contacts	1 CO contact	2 CO contacts	1 CO contact	-	-	1 CO contact	1 CO contact
Max. switching capacity AC	2000VA (8A / 250V)	2000VA (8A / 250V)	2000VA (8A / 250V)	-	-	2000VA (8A / 250V)	2000VA (8A / 250V)
Analogue output	-	-	-	0 – 10V DC	0 – 20mA	-	-
DESIGN							
Dimensions (w x h x d)	17.5 x 87 x 65 mm	35 x 87 x 65 mm	17.5 x 87 x 70 mm	17.5 x 87 x 70 mm	17.5 x 87 x 70 mm	17.5 x 87 x 70 mm	17.5 x 87 x 70 mm
Certificates	CE, GOST						

THIS IS A SMALL OVERVIEW OF OUR PRODUCTS FOR THE ENTIRE PRODUCT RANGE PLEASE VISIT www.tele-online.com

TYPE DESIGNATION	FUNCTION	RATED VOLTAGE	RELAY VOLTAGE	NUMBER OF SWITCHING CONTACTS	ART. NO.	
SKR 524	Coupling relay for PLC applications	24V	AC/DC	1 CO contact	180501	
SKR 024		24V	DC		180500	
SKR 730		230V	AC		180502	
STKR 524	Coupling relay for PLC applications with pluggable changeover relay	24V	AC/DC		24V DC	180504
STKR 024		24V	DC		24V DC	180503
STKR 730		230V	AC		60V DC	180505
RM699V-3011-85-1024	Pluggable changeover relay	24V	DC		100660	
RM699V-3011-85-1060		48V	DC		100661	
ACCESSORIES	FUNCTION	COLOUR	NUMBER OF POLES	ART. NO.		
PB-B SKR	Jumper link	Blue	20	180535		
PB-R SKR		Red		180536		



SKR

TYPE DESIGNATION	RATED VOLTAGE	LED	GOLD-PLATED CONTACTS	NUMBER OF SWITCHING CONTACTS	ART. NO.
RA 524L-N	24V	■		2 CO contacts	100623LD-N
RA 615L-N	115V	■			100621LD-N
RA 730L-N	230V	■			100624LD-N
RA 012L-N	12V	■		4 CO contacts	100625LD-N
RA 024L-N	24V	■			100622LD-N
RM 512L-N	12V	■			100612LD-N
RM 524L-N	24V	■			100613LD-N
RM 615L-N	115V	■			100618LD
RM 730L-N	230V	■			100619LD
RM 012L	12V	■		1 CO contacts	100601LD-N
RM 024L-N	24V	■			100603LD-N
RM 048L-N	48V	■			100602LD-N
RM 220L-N	220V	■			100620LD-N
RP 524-1	24V			1 CO contacts	100431
RP 730-1	230V				100432
RP 024-1	24V				100430
RP 524-2	24V			2 CO contacts	100417
RP 730-2	230V				100418
RP 012-2	12V				100420
RP 024-2	24V				100416
RP 024-hv	24V		■		100416H



RA



RM



RP

TYPE DESIGNATION	RATED VOLTAGE	LED	RECOVERY DIODE	GOLD-PLATED CONTACTS	NUMBER OF SWITCHING CONTACTS	ART. NO.
RT 1.2.012L	12V	■			2 CO contacts	100508LD
RT 1.2.024L	24V	■				100507LD
RT 1.2.110L	110V	■				100505LD
RT 1.2.230L	230V	■			2 CO contacts	100502LD
RT 2.2.012L	12V	■				100517LD
RT 2.2.024L	24V	■				100516LD
RT 1.3.024L	24V	■			3 CO contacts	100526LD
RT 1.3.048L	48V	■				100524LD
RT 1.3.110L	110V	■				100522LD
RT 1.3.230	230V					100521
RT 1.3.230L	230V	■				100521LD
RT 1.3.230.02L	230V	■		■		100521H
RT 2.3.012L	12V	■			3 CO contacts	100536LD
RT 2.3.024	24V					100535
RT 2.3.024L	24V	■				100535LD
RT 2.3.024LD	24V	■	■			100535FD
RT 2.3.024.02LD	24V	■	■	■		100535H
RT 2.3.048L	48V	■				100533LD
RT 2.3.110	110V				100531	
RT 2.3.220	220V				100530	



RT



COM3T + PF-113BE/M

TYPE DESIGNATION	FUNCTIONS	TIME RANGES	SUPPLY VOLTAGE	NUMBER OF SWITCHING CONTACTS	DIMENSIONS (W X H X D)	ART. NO.
COM3T	8 E, R, Ws, Wa, Wu, Es, Bp, Bi	8 (0.05 s – 10 d)	24 – 240V AC/DC	2 or 3 CO contacts (according to selected industrial relay)	35 x 12 x 47 mm	237010

Sockets for switching relays

TYPE DESIGNATION	FOR SERIES	RATED VOLTAGE	ART. NO.
PYF14BE (ES 15/4N)	RA, RM	300V AC	180134
PYF14BE3 (ES 15/4S)			180145
PYF14BE3CC (ES 15/4G)			180148
ES 15/4B			180046
RSS214	RM		180050
PI50BE/3R	RP		180150
PI50BE			180137
PSS8/3			180056
PF083BE	RT 8-pin		180139
ES 9	RT 11-pin		180041
PF113BEM			180136
R11X			180055



Socket ES15/4N



Socket ES15/4G



Socket PSS8



Socket R11X

Modules and accessories for switching relays

TYPE DESCRIPTION	TYPE DESIGNATION	FOR SERIES	RATED VOLTAGE	ART. NO.
Diode	PYF	M21N	6 – 230V DC (+A1)	180261
LED (red) + Diode	PYF	M41R	6 – 24V DC (+A1)	180263
LED (green) + Diode	RSS214	EM 12	6 – 24V DC (+A1)	180309
Retaining Clip (metal)	RSS214, ES, PYF	HB/RM-RA		180032
Retaining Clip (plastic)	ES, PYF	HB/ES15		P0000033
LED + Diode	PF113BEM	TYPE41 (TVL1)	6 – 24V DC (+A1)	180232
Retaining Clip (metal)	PF083BE, PF113BEM, ES9, R11X	HB/RT		180043
RC-link	PSS	EM 03	110 – 230V AC	180300
Retaining Clip (plastic)	PI50	HB/RP 16		180029
Retaining Clip (plastic)	PSS8/3	HB/PSS		180060
Front cover (label field)	PSS8/3	BS/PSS		180057

TYPE DESIGNATION	MOTOR CONTROL	NOMINAL CURRENT	NOMINAL MOTOR POWER	DIMENSIONS	ART. NO.
TSG 2,2 230VAC	1-phase	5A	1.3kW (1~ 230V)	22.5 x 75 x 111 mm	490251
TSG 2,2 400VAC		5A	2.2kW (3~ 400V)	22.5 x 75 x 111 mm	490250
MSG 3-3s 400VAC	3-phase	6A	3kW	45 x 76 x 117 mm	490000
MSG 3-30s 400VAC		6A	3kW	45 x 76 x 117 mm	490002
MSG 5,5 400VAC		11A	5.5kW	70 x 76 x 117 mm	490007
MSG 11 400VAC		22A	11kW	100 x 76 x 117 mm	490008
ACCESSORIES	DESCRIPTION			ART. NO.	
FA-MSG 3	Front cover MSG 3 (sealable)			490245	
FA-MSG 5,5	Front cover MSG 5,5 (sealable)			490246	



TSG



MSG



ESG

MS3 softstarter

TYPE DESIGNATION	MOTOR CONTROL	NOMINAL CURRENT	NOMINAL MOTOR POWER	DIMENSIONS	ART.NO.
MS3 2,2	3-phase	4.5A	2.2kW	42x128x130 mm	490460
MS3 3,0		6.6A	3.0kW	42x128x130 mm	490461
MS3 4,0		8.5A	4.0kW	42x128x130 mm	490462
MS3 5,5		12A	5.5kW	42x128x130 mm	490463
MS3 7,5		18A	7.5kW	51x141x181 mm	490464
MS3 11,0		25A	11kW	51x141x181 mm	490465
MS3 15,0		30A	15kW	51x224x179 mm	490466
MS3 18,5		37A	18.5kW	51x224x179 mm	490467
MS3 22,0		45A	22kW	51x224x179 mm	490468

ESG series softstarter (softstarter < 11kW and > 90kW available upon request)

TYPE DESIGNATION	MOTOR CONTROL	NOMINAL CURRENT	NOMINAL MOTOR POWER	DIMENSIONS	ART.NO.
ESG 30-400	3-phase without current limitation	240A	30kW	360 x 250 x 170 mm	490055
ESG 45-400		350A	45kW	360 x 250 x 170 mm	490065
ESG 55-400		420A	55kW	360 x 250 x 170 mm	490070
ESG 75-400		600A	75kW	360 x 250 x 170 mm	490075
ESG 90-400		700A	90kW	360 x 250 x 170 mm	490080
ESG-I 30-400	3-phase with current limitation	240A	30kW	360 x 250 x 170 mm	490056
ESG-I 45-400		350A	45kW	360 x 250 x 170 mm	490067
ESG-I 55-400		420A	55kW	360 x 250 x 170 mm	490072
ESG-I 75-400		600A	75kW	360 x 250 x 170 mm	490076
ESG-I 90-400		700A	90kW	360 x 250 x 170 mm	490081
ADDITIONAL OPTIONS	DESCRIPTION			ART. NO.	
/BG ESG	Braking module (ESG 30kW and higher)			AS0019	
/24VDC ESG	Control voltage; 24V DC			AS0020	
/400VAC ESG	Control voltage; 400V AC			AS0021	



MBG series motor braking unit (compact design)

TYPE DESIGNATION	MAX. BRAKING CURRENT	RECOMMENDED MOTOR POWER	DIMENSIONS	ART. NO.
MBG10 230V AC	10A	2.2kW	76 x 45 x 117 mm	499110
MBG20 400V AC	20A	5.5kW	70 x 101 x 117 mm	499111
MBG35 400V AC	35A	11kW	101 x 101 x 117 mm	499112



MBG35



BG



TST3

BG series motor braking unit (open design, motor braking units with braking current up to 2000A available upon request)

TYPE DESIGNATION	MAX. BRAKING CURRENT	RECOMMENDED MOTOR POWER	DIMENSIONS	ART. NO.
BG 20 / 400	18A	4kW	200 x 140 x 115 mm	499950
BG 60	60A	15kW	260 x 195 x 170 mm	499982
BG 100	100A	22kW	260 x 195 x 170 mm	499981
BG 150	150A	30kW	260 x 195 x 170 mm	499983
BG 220	220A	55kW	260 x 195 x 170 mm	499984
BG 300	300A	75kW	260 x 195 x 170 mm	499955

TST series thyristor control unit (compact design)

TYPE DESIGNATION	LOAD	MAX. LOAD CURRENT	DIMENSIONS	ART. NO.
TST1 05	1-phase	5A	93 x 130 x 103 mm	499996
TST1 15		15A	93 x 130 x 103 mm	499991
TST1 25		25A	93 x 130 x 103 mm	499992
TST1 35		35A	93 x 130 x 103 mm	499993
TST1 50		50A	93 x 130 x 103 mm	499994
TST1-SP 05		5A	93 x 130 x 103 mm	499996S
TST1-SP 15		15A	93 x 130 x 103 mm	499991S
TST1-SP 25		25A	93 x 130 x 103 mm	499992S
TST1-SP 35		35A	93 x 130 x 103 mm	499993S
TST1-SP 50		50A	93 x 130 x 103 mm	499994S
TST3 05 3x400/230V	3-phase 3- or 4-wire system	5A	140 x 200 x 135 mm	499053
TST3 15 3x400/230V		15A	140 x 200 x 135 mm	499050
TST3 25 3x400/230V		25A	140 x 200 x 135 mm	499051
TST3 35 3x400/230V		35A	140 x 200 x 135 mm	499052
TST3 50 3x400/230V		50A	140 x 200 x 135 mm	499054
ADDITIONAL OPTIONS	DESCRIPTION		ART. NO.	
/IV 230VAC TST1	Internal power supply 230V AC		AS0029	
/IV 400VAC TST1	Internal power supply 400V AC		AS0033	
/400VAC TST3	Internal power supply 400V AC (integrated in the device)		AS0032	

ESGT series thyristor control unit (open design, 3-phase AC-controller; ESGT with load current up to 1000A available upon request)

TYPE DESIGNATION	LOAD	MAX. LOAD CURRENT	DIMENSIONS	ART. NO.	
ESGT 75	3-phase, 3- or 4-wire system Phase clipping control	75A	360 x 252 x 170 mm	490218	
ESGT 90		90A	360 x 252 x 170 mm	490220	
ESGT 120		120A	360 x 252 x 170 mm	490205	
ESGT 160		160A	360 x 252 x 170 mm	490210	
ESGT 220		220A	360 x 445 x 240 mm	490212	
ESGT 350		350A	360 x 445 x 240 mm	490215	
ESGT 420		420A	360 x 445 x 240 mm	490370	
ESGT 560		560A	600 x 540 x 346 mm	490373	
ESGT 720		720A	600 x 540 x 346 mm	490376	
ESGT 1000		1000A	600 x 540 x 346 mm	490379	
ESGT 1600		1600A	850 x 750 x 470 mm	490385	
ESGT-SP 75		3-phase, 3-wire system Burst control	75A	360 x 252 x 170 mm	490354
ESGT-SP 90			90A	360 x 252 x 170 mm	490355
ESGT-SP 120	120A		360 x 252 x 170 mm	490342	
ESGT-SP 160	160A		360 x 252 x 170 mm	490344	
ESGT-SP 220	220A		360 x 445 x 240 mm	490345	
ESGT-SP 350	350A		360 x 445 x 240 mm	490350	
ESGT-SP-N 90	3-phase, 4-wire system Burst control	90A	360 x 252 x 170 mm	490368	
ESGT-SP-N 220		220A	360 x 445 x 240 mm	490360	



ESGT

ESGT series thyristor control unit (open design, 1-phase AC-controller; ESGT with load current up to 350A available upon request)

TYPE DESIGNATION	LOAD	MAX. LOAD CURRENT	DIMENSIONS	ART. NO.
ESGT-1PH 75	1-phase Phase clipping control	75A	260 x 205 x 170mm	490317
ESGT-1PH 90		90A	260 x 205 x 170mm	490318
ESGT-1PH 220		220A	360 x 250 x 170mm	490224
ESGT-1PH 350		350A	360 x 250 x 170mm	490314
ESGT-1PH-SP 75	1-phase	75A	260 x 205 x 170mm	490329
ESGT-1PH-SP 90		90A	260 x 205 x 170mm	490330
ESGT-1PH-SP 220	Burst control	220A	360 x 250 x 170mm	490322

ESGT series additional options and accessories

ADDITIONAL OPTIONS	LOAD	DESCRIPTION	ART. NO.	
/J ESGT	3-phase	Constant-current regulation, 3 current transformers	AS0008	
/U ESGT		Constant-voltage regulation	AS0009	
/IB ESGT		Current-limit control with high-speed disconnection	AS0010	
/AI ESGT		Current output (0-100% nominal current equ. 0-10V)	AS0011	
/AU ESGT		Voltage output 0-10V trimmable to nominal voltage	AS0012	
/24V DC ESGT		Control voltage 24V DC	AS0013	
/400VAC ESGT		Control voltage 400V AC	AS0014	
/J ESGT-1PH		1-phase	Constant-current regulation, current transformer included	AS0001
/U ESGT-1PH			Constant-voltage regulation	AS0002
/IB ESGT-1PH			Current-limit control with high-speed disconnection	AS0003
/AI ESGT-1PH			Current output (0-100% nominal current equ. 0-10V)	AS0004
/AU ESGT-1PH			Voltage output 0-10V trimmable to nominal voltage	AS0005
/24V DC ESGT-1PH	Control voltage 24V DC		AS0006	
/400VAC ESGT-1PH	Control voltage 400V AC		AS0007	
ACCESSORIES	DESCRIPTION		ART. NO.	
R20 10KOHM	Remote potentiometer, scale 1-10, 10kΩ		282131	

TSC series digital time switches



TSC28

DAILY-, WEEKLY- OR YEARLY PROGRAM, DIN-RAIL MOUNTING									
TYPE DESIGNATION	SUPPLY VOLTAGE	CHANNELS	NUMBER OF SWITCHING CONTACTS		ASTRO FUNCTION	SWITCHING CAPACITY	RATED CONSUMPTION	DIMENSIONS	ART. NO.
			CO	NO					
TSC18.10	230V AC	1		1		4000VA	1.5VA	35.8 x 90 x 60 mm	711144
TSC28.11	230V AC	1	1			4000VA	1.5VA	35.8 x 90 x 60 mm	711142
TSC28.21	230V AC	2	2			4000VA	1.5VA	35.8 x 90 x 60 mm	711143
TSC28.23	230V AC	2	2		■	4000VA	1.5VA	35.8 x 90 x 60 mm	711147
TSC98.20	230V AC	2	2			2500VA	2VA	71.5 x 120 x 60 mm	711132
TSC98.40	230V AC	4	3	1		2500VA	2VA	71.5 x 120 x 60 mm	711131

DAILY-, WEEKLY- OR YEARLY PROGRAM, FRONT PANEL MOUNTING									
TYPE DESIGNATION	SUPPLY VOLTAGE	CHANNELS	NUMBER OF SWITCHING CONTACTS		SWITCHING CAPACITY	RATED CONSUMPTION	DIMENSIONS	ART. NO.	
			CO	NO					
TSC44.12	24V AC	1	1		4000VA	0.9VA	72 x 94.5 x 53 mm	711676	
TSC44.12	115V AC	1	1		4000VA	2.8VA	72 x 94.5 x 53 mm	711576	
TSC44.12	230V AC	1	1		4000VA	1.5VA	72 x 94.5 x 53 mm	711578	
TSC44.22	24V AC	2	1	1	4000VA	1.3VA	72 x 94.5 x 53 mm	711679	
TSC44.22	230V AC	2	1	1	4000VA	1.5VA	72 x 94.5 x 53 mm	711579	

TTC series digital time switches



TTC24.21

COUNTDOWN TIMER, FRONT PANEL MOUNTING					
TYPE DESIGNATION	SUPPLY VOLTAGE	TIME RANGE	NUMBER OF SWITCHING CONTACTS	DIMENSIONS	ART. NO.
TTC24.21	230V AC	99 h 59 min 59 s	1 CO contact	48 x 48 x 41 mm	711450

TBG, TBW series analogue hour meters



TBG/TBW30

TBG SERIES, DC VOLTAGE					
TYPE DESIGNATION	SUPPLY VOLTAGE	COUNTING CAPACITY	ACCURACY OF READING	DIMENSIONS	ART. NO.
TBG30.18	12 - 48V DC	999 999 h	0.1 h	53.2 x 28.2 x 63 mm	711056
TBG40.17				48 x 48 x 38 mm	711025
TBG70.18		99 999 h		17.5 x 85 x 61.5 mm	711435
TBG70.29				35 x 90 x 60 mm	711408



TBG/TBW40

TBW SERIES, AC VOLTAGE						
TYPE DESIGNATION	SUPPLY VOLTAGE	RATED FREQUENCY	COUNTING CAPACITY	ACCURACY OF READING	DIMENSIONS	ART. NO.
TBW40.18	24V AC	50 Hz	99 999 h	0.01 h	48 x 48 x 38 mm	711056
TBW40.18	115V AC				48 x 48 x 38 mm	711025
TBW70.18	115V AC				17.5 x 85 x 61.5 mm	711435
TBW30.18	230V AC				53.2 x 28.2 x 63 mm	711408
TBW40.18	230V AC	50/60 Hz	99 999 h	0.1 h	48 x 45 x 38 mm	711045
TBW70.18	230V AC				17.5 x 85 x 61.5 mm	711042
TBW70.29	24V AC				35 x 90 x 60 mm	711434
TBW70.89	48V AC				35 x 105 x 60 mm	711050
TBW70.89	115V AC	50/60 Hz	99 999 h	0.1 h	35 x 105 x 60 mm	711040
TBW70.89	230V AC				35 x 105 x 60 mm	711430
TBW70.29	230V AC				17.5 x 85 x 61.5 mm	711355



TBG/TBW70.18

ACCESSORIES TBG, TBW	DESCRIPTION	ART. NO.
SB-TBX30	Tension bracket for TBG/TBW30	711809
B55-TBX40	Shutter for TBG/TBW40 (55 x 55mm)	711800
ME72-TBX40	Screen for TBG/TBW40 (72 x 72mm)	711801
SB-TBX40	Retaining clip for TBG/TBW40	711807
DR-TBW40	Sealing ring for TBW40 (IP54)	711813
KA-TBX70.29	Terminal cover for TBG/TBW70.29 (sealable)	711812

S² series safety relays

TYPE DESIGNATION	S2NGS031	S2NGS031	S2NG021	S2NT031	S2Z021	S2NGR120 3S	S2K043	S2KR403 3S
ORDER INFORMATION								
Art. No.	588066	588062	588814	588811	588818	588816	588821	588822
FUNKTIONEN								
PL Applications in accordance with EN ISO 13849-1 up to PL	e	e	e	d	e	e ¹⁾	d ²⁾	d ²⁾
Cat. Applications in accordance with EN ISO 13849-1 up to category	4	4	4	2	4	4 ¹⁾	3 ²⁾	3 ²⁾
SIL Applications in accordance with EN 62062 up to SIL _{CL}	3	3	3	2	3	3 ¹⁾	2 ²⁾	2 ²⁾
Emergency stop monitoring	■	■	■	■		■		
Protective gate monitoring	■	■	■	■	■	■		
Safety light grid in accordance with EN 61496-1 BWS type 4	■		■			■		
Two-hand control according to EN 574					IIIC			
Controlled stop according to EN 60204-1 stop Category 1						■		■
Safety shut-off mat monitoring (4-wire principle, short-circuiting)	■	■	■					
Elevator systems according to EN 81-1	■	■						
Combustion plants according to EN 50156-1	■	■						
Contact expansion							■	■
INPUT CIRCUIT								
Single-channel input circuit 1 NC contact or semiconductor	■	■	■	■		■	■	■
Two-channel input circuit 2 NC contacts or semiconductors	■	■	■			■		
Two-channel input circuit 2 NO/NC contacts or semiconductors	■	■			■			
Rated voltage AC		115 - 230V	24V	24V	24V		24V	
Rated voltage DC	24V		24V	24V	24V	24V	24V	24V
FEATURES								
Synchronous time monitoring	1.5 s	1.5 s			0.5 s			
Automatic Reset	■	■	■	■	■	■		
Manual Reset			■	■		■		
Reset button monitoring	■	■	■	■		■		
RETRIGGER - Reset of time lapse for OFF-delayed contacts						■		■
OUTPUT CIRCUIT								
Switching contacts (NO / NC)	3 / 1	3 / 1	2 / 1	3 / 1	2 / 1	2	4 / 1	
OFF-delayed contacts (NO / NC)						1		4 / 1
DESIGN								
Dimensions (w x h x d)	22.5 x 96.5 x 114 mm							
Certificates	TÜV, CE							

1) applies to undelayed contacts; the following applies to delayed contact: PL = d / Cat. = 3 / SILCL = 2
2) depends on the category of the basic device of the safety analysis



DRAN30-24A



DRA 480-24A* (Backup)



AMR1-24

INDUSTRIAL HOUSING FOR SWITCH CABINET AND PLANT CONSTRUCTION

- ✓ Output voltage 5 - 48V DC
- ✓ Output power 5 - 960W
- ✓ Overload and short circuit protection

Output voltage	Output power	Output current
5V DC	5W	1A
	10W	2A
	15W	3A
	30W	6A
	50W	10A
12V DC	10W	0.8A
	18W	1.5A
	30W	2.5A
	42W	3.5A
	60W	5A
	76W	6.3A
	120W	10A
15V DC	5W	0.3A
	18W	1.2A
	42W	2.8A
24V DC	5W	0.2A
	10W	0.4A
	18W	0.8A
	30W	1.25A
	48W	2A
	60W	2.5A
	75W	3.2A
	120W	5A
	240W	10A
	300W	12.5A
48V DC	120W	2.5A
	240W	5A
	480W	10A

INDUSTRIAL HOUSING FOR BACK-UP SYSTEMS

- ✓ Power supply units with total discharge
- ✓ For back-up systems (e.g. batteries)
- ✓ Output voltage 12 - 28.5V DC
- ✓ Output power 30 - 480W

Output voltage	Output power	Output current
12V DC	30W	2.2A
	60W	4.4A
	120W	8.8A
24V DC	30W	1.1A
	60W	2.2A
	120W	4.4A
	240W	8.8A
	480W	17.6A

INSTALLATION HOUSING FOR BUILDING AND PLANT ENGINEERING

- ✓ Output voltage 12 - 24V DC
- ✓ Output power 10 - 100W
- ✓ Overload and short circuit protection

Output voltage	Output power	Output current
12V DC	10W	0.8A
	24W	2A
	54W	4.5A
	90W	7.5A
24V DC	10W	0.4A
	24W	1A
	36W	1.5A
	60W	2.5A
	100W	4.2A

ARTICLE NUMBERS AND MORE INFOS ABOUT DC POWER SUPPLIES

www.tele-online.com

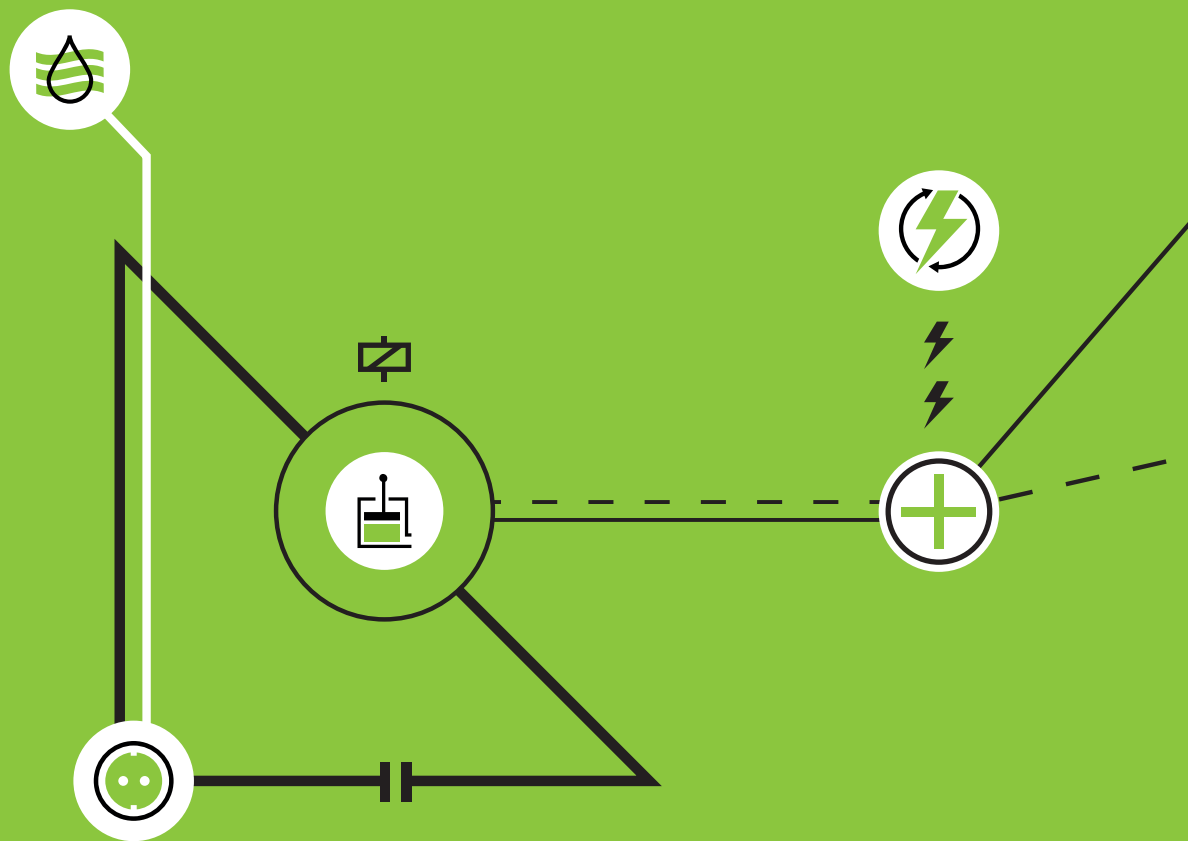

For contact data of your local distributor please visit
<http://www.tele-online.com/en/organization/distribution/>

Art.nr.: 091113 / V1.0



TELE Haase Steuergeräte Ges.m.b.H.

Vorarlberger Allee 38
A-1230 Wien
Austria

CALL US



+43 / 1 / 614 74 - 0

ONLINE SUPPORT



info@tele-online.com

WEB



www.tele-online.com