







## FLOWave SAW flowmeter

- No obstacles inside the measuring tube, compact, lightweight and low energy consumption
- Conforms to hygienic requirements, CIP/SIP compatible
- Ideal for liquids with low or no conductivity
- Digital communication, parameterisation via Communicator, display and Wi-Fi
- Optional: ATEX certification, II 3G/D

Product variants described in the data sheet may differ from the product presentation and description.

### Can be combined with

|   |   |   |
|---|---|---|
|  | <b>Type 8802</b><br>ELEMENT continuous control valve systems - overview                 | ▶ |
|  | <b>Type 8619</b><br>multiCELL - Multi-channel and multi-function transmitter/controller | ▶ |
|  | <b>Type 8647</b><br>AirLINE SP – electro-pneumatic automation system                    | ▶ |
|  | <b>Type ME43</b><br>Fieldbus gateway  | ▶ |

### Type description

The Type 8098 flowmeter is part of the FLOWave product range. It is based on SAW (Surface Acoustic Waves) technology and is mainly designed for applications with the highest hygienic demands. This is achieved by using:

- suitable stainless steel materials
- a measuring tube free of any wetted parts except for the actual tube
- the ideal outer hygienic design.

FLOWave offers a range of integrated functions, including the advantages of flexibility, ease of cleaning, compact dimensions, lightweight, easy installation and handling, and is compliant with numerous standards.

Optimal measurement results can be achieved with homogeneous liquids, free of air and solid particles. For liquids with high viscosity, an integrated viscosity compensation can be activated. Gas and steam cannot be measured; however, their flow does not have any negative effect on the device or its operation and other liquids flowing through afterwards are measured correctly as before. Special functions derived from further process values (density factor, acoustic transmission factor) offer additional information about the particular liquid in use (for details, see chapter “7.2. Special functions” on page 27).

DTS 1000270652 EN Version: P Status: RL (released | freigegeben | valide) printed: 30.04.2021



## Table of contents

|  |           |
|--|-----------|
| <b>1. General technical data</b>   | <b>4</b>  |
| 1.1. About the FLOWave flowmeter .....   | 4         |
| 1.2. All versions .....  | 4         |
| 1.3. FLOWave L flowmeter .....   | 8         |
| With or without industrial communication .....                                     | 8         |
| With industrial communication (Ethernet version) .....                             | 9         |
| 1.4. FLOWave S flowmeter .....   | 11        |
| <b>2. Approvals</b>  | <b>13</b> |
| 2.1. Certification .....   | 13        |
| 2.2. Certificates .....  | 13        |
| 2.3. Pressure Equipment Directive .....  | 14        |
| Device used on a pipe .....  | 14        |
| <b>3. Materials</b>  | <b>14</b> |
| 3.1. Chemical Resistance Chart – Bürkert resistApp .....                           | 14        |
| 3.2. Material specifications .....   | 15        |
| FLOWave L flowmeter without industrial communication .....                         | 15        |
| FLOWave L flowmeter with industrial communication .....                            | 16        |
| FLOWave S flowmeter .....  | 17        |
| <b>4. Dimensions</b>   | <b>18</b> |
| 4.1. Transmitter of the FLOWave L flowmeter without industrial communication ..... | 18        |
| 4.2. Transmitter of the FLOWave L flowmeter with industrial communication .....    | 18        |
| 4.3. Transmitter of the FLOWave S flowmeter .....                                  | 18        |
| 4.4. Flowmeter with clamp process connection .....                                 | 19        |
| 4.5. Flowmeter with aseptic collar flange (BF) .....                               | 21        |
| 4.6. Flowmeter with aseptic collar clamp (BKS) .....                               | 22        |
| 4.7. Flowmeter with thread connection .....  | 23        |
| <b>5. Performance specifications</b>   | <b>23</b> |
| 5.1. Medium temperature .....  | 23        |
| 5.2. Measurement deviation .....   | 24        |
| <b>6. Product installation</b>   | <b>25</b> |
| 6.1. Installation notes .....  | 25        |
| 6.2. Selection of the nominal diameter .....                                       | 25        |
| 6.3. Mounting options .....  | 26        |
| FLOWave L flowmeter .....  | 26        |
| FLOWave S flowmeter .....  | 26        |
| <b>7. Product operation</b>  | <b>27</b> |
| 7.1. Measuring principle .....   | 27        |
| 7.2. Special functions .....   | 27        |
| <b>8. Product design and assembly</b>  | <b>28</b> |
| 8.1. Product assembly .....  | 28        |
| <b>9. Product accessories</b>  | <b>29</b> |

## 10. Ordering information

29

|  |    |
|--|----|
| 10.1. Bürkert eShop – Easy ordering and quick delivery.....  | 29 |
| 10.2. Recommendation regarding product selection .....   | 29 |
| 10.3. Bürkert product filter.....  | 30 |
| 10.4. Bürkert 3D Model - Interactive Animation .....   | 30 |
| 10.5. Ordering chart FLOWave L flowmeter with or without industrial communication .....                    | 31 |
| Clamp process connection acc. to DIN 32676 series A for pipe acc. to DIN 11866 series A (DIN 11850).....   | 31 |
| Clamp process connection acc. to DIN 32676 series B for pipe acc. to DIN 11866 series B (ISO 1127).....    | 32 |
| Clamp process connection acc. to DIN 32676 series C for pipe acc. to DIN 11866 series C (ASME BPE) .....   | 33 |
| Thread process connection acc. to DIN 11851 series A for pipe acc. to DIN 11866 series A (DIN 11850) ..... | 34 |
| 10.6. Ordering chart FLOWave S flowmeter .....   | 35 |
| Clamp process connection acc. to DIN 32676 series A for pipe acc. to DIN 11866 series A (DIN 11850).....   | 35 |
| Clamp process connection acc. to DIN 32676 series B for pipe acc. to DIN 11866 series B (ISO 1127).....    | 36 |
| Clamp process connection acc. to DIN 32676 series C for pipe acc. to DIN 11866 series C (ASME BPE) .....   | 37 |
| Thread process connection acc. to DIN 11851 series A for pipe acc. to DIN 11866 series A (DIN 11850) ..... | 38 |
| 10.7. Ordering chart accessories.....  | 39 |

## 1. General technical data

### 1.1. About the FLOWave flowmeter

The flowmeter Type 8098 consists of:

- either a flow sensor Type S097 and a transmitter Type SE98 (version FLOWave L flowmeter), which is available with or without industrial communication (the FLOWave L version with industrial communication, recognisable by the two M12 female connectors and the M12 male connector, is called the Ethernet version.)



- or a flow sensor Type S097 and a transmitter Type SE91 (version FLOWave S flowmeter)



### 1.2. All versions

The following data applies to all versions.

#### Product properties

##### Material

Please make sure the device materials are compatible with the fluid you are using.

Detailed information can be found in chapter [“3.1. Chemical Resistance Chart – Bürkert resistApp”](#) on page 14.

Detailed information on the materials can be found in chapter [“3.2. Material specifications”](#) on page 15.

##### Non wetted parts

- |                |   |
|----------------|---|
| Sensor housing | <ul style="list-style-type: none"> <li>• For sensor with process connection <math>\leq</math> DN 50/2": stainless steel 304/1.4301</li> <li>• For sensor with process connection <math>&gt;</math> DN 50/2": stainless steel 316L/1.4435</li> </ul> |
|----------------|---|

##### Wetted parts

|                            |  |
|----------------------------|--|
| Measurement tube and clamp | Stainless steel 316L/1.4435 with low delta ferrite content |
|----------------------------|--|

|            |  |
|------------|--|
| Dimensions | Detailed information can be found in chapter <a href="#">“4. Dimensions”</a> on page 18. |
|------------|--|

##### Surface quality

- |                                  |  |
|----------------------------------|--|
| Measurement tube (inner surface) | <ul style="list-style-type: none"> <li>• Ra <math>&lt;</math> 0.8 <math>\mu</math>m (30 <math>\mu</math>in.) or</li> <li>• Ra <math>&lt;</math> 0.4 <math>\mu</math>m (15 <math>\mu</math>in.) (electro-polished) according to ISO 4288</li> </ul> |
|----------------------------------|--|

|   |  |
|---|--|
| Measurement tube (outer surface), housing | Ra $<$ 1.6 $\mu$ m (excluding welding seams) according to ISO 4288 |
|---|--|

##### Measuring range

|                              |  |
|------------------------------|--|
| Volume flow rate measurement | 0...1.7 m <sup>3</sup> /h up to 0...200 m <sup>3</sup> /h<br>Detailed information can be found in chapter <a href="#">“10.5. Ordering chart FLOWave L flowmeter with or without industrial communication”</a> on page 31 or <a href="#">“10.6. Ordering chart FLOWave S flowmeter”</a> on page 35. |
|------------------------------|--|

|                         |                              |
|-------------------------|------------------------------|
| Temperature measurement | -20...+140 °C (-4...+284 °F) |
|-------------------------|------------------------------|

|                  |  |
|------------------|--|
| Special function | <ul style="list-style-type: none"> <li>• ATF: acoustic transmission factor</li> <li>• DF: density factor</li> </ul> <p>Active by default, deselectable upon request. Detailed information can be found in chapter <a href="#">“7.2. Special functions” on page 27.</a></p> |
|------------------|--|

### Performance data

#### Volume flow rate measurement

Under reference conditions i.e. measuring fluid = water free from gas bubbles and solids, ambient and water temperature = 23 °C ± 1 °C (73.4 °F ± 1.8 F), and short refresh time, while maintaining turbulent or laminar flow profile, with the minimum inlet (40 x DN) and outlet (1 x DN) distances and the appropriate internal diameter of the pipes. Deviation from reference conditions can be adjusted through the use of a built-in correction K factor adjustment or Teach-in Procedure.

|                       |   |
|-----------------------|---|
| Measurement deviation | <ul style="list-style-type: none"> <li>• From 10 % of full scale up to full scale: ± 0.4 % of the measured value</li> <li>• From 1 % of full scale up to 10 % of full scale: ± 0.08 % of full scale</li> </ul> <p>Detailed information can be found in chapter <a href="#">“5.2. Measurement deviation” on page 24.</a></p> |
| Repeatability         | <ul style="list-style-type: none"> <li>• From 10 % of full scale up to full scale: ± 0.2 % of the measured value</li> <li>• From 1 % of full scale up to 10 % of full scale: ± 0.04 % of full scale</li> </ul>  |
| Refresh time          | <p>Selectable:</p> <ul style="list-style-type: none"> <li>• Very short (~ 30 ms)</li> <li>• Short (~ 55 ms)</li> <li>• Long (~ 100 ms)</li> </ul>   |

#### Temperature measurement

|                       |  |
|-----------------------|--|
| Measurement deviation | <ul style="list-style-type: none"> <li>• For <math>T^{\circ} \leq 100^{\circ} \text{C}</math> (+212 °F): ± 1 °C (+ 1.8 °F)</li> <li>• For <math>100^{\circ} \text{C}</math> (+212 °F) &lt; <math>T^{\circ} &lt; 140^{\circ} \text{C}</math> (+ 284 °F): ± 1.5 %</li> </ul> |
| Refresh time          | Approx. 0.1 s  |

### Electrical data

|                                |   |
|--------------------------------|---|
| Operating voltage              | <p>The minimum voltage to be supplied depends on the fluid temperature and on the ambient operating temperature.</p> <p>Detailed information can be found in chapter <a href="#">“5.1. Medium temperature” on page 23.</a></p> <ul style="list-style-type: none"> <li>• 12...35 V DC filtered and regulated,</li> <li>• Tolerance: ± 10 %</li> <li>• Connection to main supply: permanent (through external SELV (Safety Extra Low Voltage) and LPS (Limited Power Source) power supply)</li> </ul> |
| Power Source (not supplied)    | Limited power source according to UL/EN 60950-1 standards or limited energy circuit according to UL/EN 61010-1 §9.4   |
| DC reverse polarity protection | Yes   |

#### Voltage supply cable

|  |   |
|--|---|
| For cable glands                         | <ul style="list-style-type: none"> <li>• 0.2...1.5 mm<sup>2</sup> cross-section</li> <li>• In nickel plated brass: <ul style="list-style-type: none"> <li>– Cable with maximum operating temperature greater than + 90 °C (+ 194 °F)</li> <li>– 5...14 mm diameter, shielded cable</li> </ul> </li> <li>• In stainless steel: <ul style="list-style-type: none"> <li>– Cable with maximum operating temperature greater than + 100 °C (+ 212 °F)</li> <li>– 6...12 mm diameter, shielded cable</li> </ul> </li> </ul> |
| For 5 pin M12 male connector (A-coded)   | <ul style="list-style-type: none"> <li>• Cable with maximum operating temperature greater than + 80 °C (+ 176 °F)</li> <li>• 3...6.5 mm diameter, shielded cable,</li> <li>• 0.75 mm<sup>2</sup> cross-section to connect to 5 pin M12 female connector (A-coded, not supplied)</li> </ul>  |
| For 4 pin M12 female connector (D-coded) | <ul style="list-style-type: none"> <li>• Cable with maximum operating temperature greater than + 90 °C (+ 194 °F)</li> <li>• 5e / CAT-5 min. category, 100 m max. length, shielded conductor with minimum STP</li> </ul>  |

### Medium data

|       |   |
|-------|---|
| Fluid | <p>Non-dangerous liquids complying with article 4, §1 of 2014/68/EU directive. Detailed information can be found in chapter <a href="#">“2.3. Pressure Equipment Directive” on page 14.</a></p> <p>By default the FLOWave flowmeter is set for a fluid with a sound velocity<sup>1)</sup></p> <ul style="list-style-type: none"> <li>• between 1000 m/s and 2000 m/s for DN 08, ¾" and ½" process connection or</li> <li>• between 800 m/s and 2300 m/s for process connection DN ≥ 15 or ≥ ¾"</li> </ul> |
|-------|---|

|             |   |
|-------------|---|
| Temperature | <ul style="list-style-type: none"> <li>-20...+110 °C (-4...+230 °F). The maximum fluid temperature can be restricted by the ambient operating temperature.</li> <li>Max. conditions for sterilisation process: up to +140 °C (+284 °F) (+130 °C (+266 °F) for ATEX version) for max. 60 min</li> <li>Maximum temperature gradient: 10 °C/s (18 °F/s) (measured by the integrated sensor on the device)</li> </ul> |
|-------------|---|

**Pressure (max.)**

| DN / Pipe standard       | DIN 11850 | ISO 1127 | ASME BPE | SMS 3008 |
|--------------------------|-----------|----------|----------|----------|
| DN 08, 3/8", 1/2"        | PN 25     | PN 25    | PN 25    | -        |
| DN 15, 3/4", DN 25, 1"   | PN 25     | PN 25    | PN 25    | PN 25    |
| DN 40                    | PN 25     | PN 16    | -        | PN 25    |
| 1 1/2", DN 50, 2"        | PN 16     | PN 16    | PN 16    | PN 16    |
| DN 65, 2 1/2", DN 80, 3" | PN 10     | PN 10    | PN 10    | -        |

**Process/Port connection & communication****Process connection / pipe size according to**

|   |   |
|---|---|
| DIN 32676 series A / DIN 11850          | Clamp: DN 08, DN 15, DN 25, DN 40, DN 50, DN 65 and DN 80                       |
| DIN 32676 series B / ISO 1127           | Clamp: DN 08, DN 15, DN 25, DN 40, DN 50, DN 65 and DN 80                       |
| DIN 32676 series C / ASME BPE           | Clamp: 3/8", 1/2", 3/4", 1", 1 1/2", 2", 2 1/2" and 3"                          |
| DIN 11864-2 form A series A / DIN 11850 | Aseptic collar flange (BF) <sup>2)</sup> : DN 15, DN 25, DN 40 and DN 50        |
| DIN 11864-2 form A series B / ISO 1127  | Aseptic collar flange (BF) <sup>2)</sup> : DN 08, DN 15, DN 25, DN 40 and DN 50 |
| DIN 11864-2 form A series C / ASME BPE  | Aseptic collar flange (BF) <sup>2)</sup> : 1/2", 3/4", 1", 1 1/2" and 2"        |
| DIN 11864-3 form A series A / DIN 11850 | Aseptic collar clamp (BKS) <sup>2)</sup> : DN 15, DN 25, DN 40 and DN 50        |
| DIN 11864-3 form A series B / ISO 1127  | Aseptic collar clamp (BKS) <sup>2)</sup> : DN 08, DN 15, DN 25, DN 40 and DN 50 |
| DIN 11864-3 form A series C / ASME BPE  | Aseptic collar clamp (BKS) <sup>2)</sup> : 1/2", 3/4", 1", 1 1/2" and 2"        |
| SMS 3017 / SMS 3008                     | Clamp: DN 25, DN 40 and DN 50   |
| DIN 11851 series A / DIN 11850          | Thread: DN 65 and DN 80   |
| Device status                           | LED light ring according to NAMUR NE 107  |

**Approvals and Certificates****Standards**

|                                |   |
|--------------------------------|---|
| Protection class <sup>3)</sup> | IP65, IP67 (according to IEC/EN 60529), NEMA 4X (according to NEMA250), if the product is wired and if the cable glands are tightened and the covers are screwed tight. Unused cable glands must be sealed with the stopper gaskets provided (mounted upon delivery of the product). An unused M12 fixed connector must be protected by the screwed plug. |
|--------------------------------|---|

**Directives**

|                               |   |
|-------------------------------|---|
| CE directives                 | The applied standards, which verify conformity with the EU Directives, can be found on the EU Type Examination Certificate and/or the EU Declaration of conformity (if applicable).               |
| Pressure equipment directives | Complying with Article 4, Paragraph 1 of 2014/68/EU directive<br>Detailed information on the pressure equipment directive can be found in chapter "2.3. Pressure Equipment Directive" on page 14. |

|               |   |
|---------------|---|
| Certificate   | <ul style="list-style-type: none"> <li>• FDA declaration of conformity</li> <li>• Inspection certificate 3.1</li> <li>• Certification of compliance ASME BPE</li> <li>• Calibration certificate</li> <li>• On request: <ul style="list-style-type: none"> <li>– USP class VI declaration</li> <li>– ECR1935/2004 declaration</li> <li>– CRN 0C21751 declaration<sup>4.)</sup></li> <li>– Test report 2.2</li> <li>– Certification of conformity for the surface quality DIN 4762, EN ISO 4287, EN ISO 4288</li> <li>– Certification of conformity for passivation and electropolishing processes</li> <li>– MTBF (Mean Time Between Failures) manufacturer declaration</li> </ul> </li> </ul> |
| Certification | <ul style="list-style-type: none"> <li>• EHEDG (Type EL - CLASS I)<sup>5.)</sup></li> <li>• 3A (28-06)<sup>6.)</sup></li> <li>• On request: <ul style="list-style-type: none"> <li>– UL-Listed for USA and Canada</li> <li>– ATEX<sup>6.)</sup></li> </ul> </li> </ul>  |

### Environment and installation

#### Ambient temperature

Depends on the fluid temperature. Detailed information can be found in chapter **"5.1. Medium temperature"** on page 23.

Storage -20...+70 °C (-4...+158 °F)

Relative air humidity ≤85 %, without condensation

Height above sea level Max. 2000 m

Operating conditions Continuous

Equipment mobility Fixed device

Application range Indoor and outdoor (protect the device against electromagnetic interference, ultraviolet rays and, when installed outdoors, against the effects of climatic conditions)

Installation category Category I according to UL/EN 61010-1

Pollution degree Degree 2 according to UL/EN 61010-1

1.) Customer-specific setting on request. Please contact Bürkert partners!

2.) In German: BF = Bundflansch, BKS= Bundklemmstutzen

3.) Not evaluated by UL

4.) Only for a flowmeter with a process connection size of ¼"...2", pending for the other dimensions

5.) The EHEDG compliance for :

- clamp connection according to DIN 32676 is only valid if used in combination with EHEDG-compliant gaskets from Combifit International B.V.

- threaded connection according to DIN 11851 is only valid if used in combination with EHEDG-compliant gaskets from

1. Kieselmann GmbH, Germany (ASEPTO-STAR k-flex upgrade gaskets) or

2. Siersema Componenten Service (S.K.S.) B.V. (Netherlands SKS gasket set DIN 11851 EHEDG with EPDM or FKM inner gasket)

6.) Only for a flowmeter with a process connection size of DN 08...DN 50 or ¼"...2", pending for the other dimensions

### 1.3. FLOWave L flowmeter

The FLOWave L flowmeter is available in four variants of the transmitter:

- Stainless steel transmitter with nickel plated brass cable glands and M12 male connector
- Stainless steel transmitter with stainless steel cable glands and M12 male connector (full stainless steel version)
- Stainless steel transmitter with stainless steel M12 female and male connectors and industrial communication (Ethernet version)
- Stainless steel transmitter with stainless steel cable glands and M12 male connector (ATEX version).



#### With or without industrial communication

The following data applies to all versions (unless specified differently).

#### Product properties

##### Material

Detailed information on the materials can be found in chapter “3.2. Material specifications” on page 15.

##### Non wetted parts

|   |  |
|---|--|
| Transmitter housing, blind cover                  | Stainless steel 304/1.4301   |
| Seal  | VMQ silicone (Methyl Vinyl Silicone)   |
| Display   | Float glass, stainless steel 304/1.4301  |
| Cable glands                                      | Nickel plated brass or stainless steel 304L/1.4307 or 316L/1.4404  |
| Blind plugs                                       | Black POM (polyoxymethylene) or PA6  |
| 4 pin M12 female connector and screwed plug       | Stainless steel 304L/1.4307  |
| 5 pin M12 male connector and screwed plug         | Nickel plated brass or stainless steel 316L/1.4404   |
| Pressure compensating element                     | Diaphragm in ePTFE, O-ring in silicone 60 Shore A, body in stainless steel   |
| Display module                                    | 2.4", monochrome graphic (240 × 160 pixels)<br>German, English, French languages   |
| Wi-Fi module Approved for Europe, USA and Canada) | <ul style="list-style-type: none"> <li>• Can be used with or without display module</li> <li>• Wi-Fi module (wireless standard 802.11b/g/n) with integrated web server, offers the same setting options as the display</li> <li>• Transmission power: approx. 50 mW</li> <li>• Radio range limited to approx. 10 m</li> <li>• Integration into existing Wi-Fi infrastructure possible</li> </ul> |

##### Requirements:

- Windows 7, 8.1 or 10: IE11, Edge, Google Chrome, from version 53
- Android: Google Chrome, from version 53
- Apple: Safari, from iOS 9.3.5

| Weight (approx. in kg) | DN 08,<br>3/8", 1/2" | DN 15,<br>3/4" | DN 25,<br>1" | DN 40,<br>1 1/2" | DN 50,<br>2" | DN 65,<br>2 1/2" | DN 80,<br>3" |
|------------------------|----------------------|----------------|--------------|------------------|--------------|------------------|--------------|
| Clamp                  | 2.1                  | 2              | 2.2          | 3                | 3.2          | 5.4              | 5.5          |
| Flange                 | 2.3                  | 2.4            | 2.7          | 3.6              | 3.8          | –                | –            |
| Thread (dairy thread)  | –                    | –              | –            | –                | –            | 5.7              | 6.1          |

#### Performance data

|                              |                                |
|------------------------------|--------------------------------|
| Frequency resolution         | 0.05 Hz over 0...2000 Hz range |
| 4...20 mA output uncertainty | ±0.04 mA                       |



|  |   |
|--|---|
| 4...20 mA output resolution  | 0.8 $\mu$ A   |
| <b>Electrical data</b>   |   |
| Power consumption  | Without any consumption of output <ul style="list-style-type: none"> <li>For device with 2 x M20 x 1.5 cable glands and 1 x 5 pin M12 connector: max. 5 W</li> <li>For device with 2 x 4 pin M12 connectors and 1 x 5 pin M12 connector, Ethernet version: max. 8 W</li> <li>For device with 2 x 4 pin M12 connectors and 1 x 5 pin M12 connector, Ethernet version, with display and Wi-Fi module: max. 9 W</li> </ul>   |
| <b>Outputs</b>   | Valid for non-Ethernet versions only  |
| 3 (1 digital, 1 analogue and 1 configurable): digital or analogue) |   |
| Digital outputs  | Overload information (through software diagnostics function)<br>Transistor: <ul style="list-style-type: none"> <li>Type: NPN or PNP (wiring dependent), open collector, galvanically isolated</li> <li>Operating modes: pulse (by default), On/Off, threshold, frequency (user configurable)</li> <li>0...2 kHz, 5...35 V DC, max. 700 mA, max. pulse duration: 2 s, selectable limits: 0.0001...10000 pulses/litre or 0.0001...9999.99 litres/pulse</li> <li>Protected against polarity reversals of DC and overloads</li> </ul> |
| Analogue output  | Open loop detection (through software diagnostics function)<br>Current: <ul style="list-style-type: none"> <li>4...20 mA</li> <li>3.6 mA or 22 mA to indicate an error (only if 4...20 mA scale selected); galvanically isolated</li> <li>Max. loop impedance: 1300 <math>\Omega</math> at 35 V DC, 1000 <math>\Omega</math> at 30 V DC, 700 <math>\Omega</math> at 24 V DC, 450 <math>\Omega</math> at 18 V DC</li> </ul>  |

|  |  |
|--|--|
| <b>Process/Port connection &amp; communication</b> |  |
| Electrical connection                              | 2 x M20 x 1.5 cable glands and 1 x 5 pin M12 male fixed connector (A-coded) for non-Ethernet versions only |
| Data transfer                                      | External communication through bÜS (Bürkert system bus, CANopen protocol)                                  |

|   |  |
|---|--|
| <b>Environment and installation</b>   |  |
| <b>Ambient temperature</b>  |  |
| Depends on the fluid temperature. Detailed information can be found in chapter <b>"5.1. Medium temperature"</b> on page 23. |  |
| Operation   | <ul style="list-style-type: none"> <li>For device with 2 x M20 x 1.5 cable glands and 1 x 5 pin M12 connector: <ul style="list-style-type: none"> <li>-10...+70 °C (+14...+158 °F) or -10...+40 °C (+14...+104 °F) for ATEX version, if -20 °C (4 °F) <math>\leq</math> fluid temperature <math>\leq</math> 80 °C (176 °F),</li> <li>The ambient temperature decreases linearly up to 40 °C (104 °F) at a fluid temperature of 140 °C (284 °F) or up to 30 °C (86 °F) at a fluid temperature of 130 °C (266 °F) for ATEX version, if fluid temperature &gt; 80 °C (176 °F)</li> </ul> </li> <li>For device with 2 x 4 pin M12 female connectors and 1 x 5 pin M12 connector, Ethernet version: -10...+55 °C (+14...+131 °F)</li> </ul> |

#### With industrial communication (Ethernet version)

|  |   |
|--|---|
| <b>Process/Port connection &amp; communication</b> |   |
| Electrical connection                              | 2 x 4 pin M12 female fixed connectors (D-coded) and 1 x 5 pin M12 male fixed connector (A-coded)                      |
| <b>Industrial Communication</b>                    |   |
| Supported network protocols                        | <ul style="list-style-type: none"> <li>Modbus TCP</li> <li>PROFINET</li> <li>EtherNet/IP</li> <li>EtherCAT</li> </ul> |
| LEDs   | <ul style="list-style-type: none"> <li>2 Link/Act LEDs (green)</li> <li>2 Link LEDs (yellow)</li> </ul>               |

|  |   |
|--|---|
| <b>Modbus TCP protocol</b>                 |   |
| Protocol                                   | Internet protocol, version 4 (IPv4)   |
| Network topology                           | <ul style="list-style-type: none"> <li>• Tree</li> <li>• Star</li> <li>• Line (open daisy chain)</li> </ul>   |
| IP configuration                           | <ul style="list-style-type: none"> <li>• Static IP address</li> <li>• Not supported: BOOTP (Bootstrap Protocol), DHCP (Dynamic Host Configuration)</li> </ul>   |
| Transmission speed                         | 10 or 100 MBit/s  |
| <b>PROFINET protocol</b>                   |   |
| PROFINET IO specification                  | V2.3  |
| Network topology                           | <ul style="list-style-type: none"> <li>• Tree</li> <li>• Star</li> <li>• Ring (closed daisy chain)</li> <li>• Line (open daisy chain)</li> </ul>  |
| Network management                         | <ul style="list-style-type: none"> <li>• LLDP (Link Layer Discovery Protocol)</li> <li>• SNMP V1 (Simple Network Management Protocol)</li> <li>• MIB (Management Information Base)</li> <li>• DCP (Discovery and Configuration Protocol)</li> </ul> |
| IP configuration                           | <ul style="list-style-type: none"> <li>• Manual (Device naming and IP setting)</li> </ul>   |
| Transmission speed                         | 100 MBit/s full duplex  |
| Maximum supported conformance class        | CC-B  |
| Media Redundancy (for ring topology)       | MRP client is supported   |
| GSDml file                                 | See <b>“Device Description Files”</b> on the website in the <b>Software chapter Type 8098</b> ▶   |
| <b>EtherNet/IP protocol</b>                |   |
| Protocol                                   | Internet protocol, version 4 (IPv4)   |
| Network topology                           | <ul style="list-style-type: none"> <li>• Tree</li> <li>• Star</li> <li>• Ring (closed daisy chain)</li> <li>• Line (open daisy chain)</li> <li>• Linear (open Daisy Chain)</li> </ul>   |
| IP configuration                           | <ul style="list-style-type: none"> <li>• Static IP address</li> <li>• BOOTP (Bootstrap Protocol)</li> <li>• DHCP (Dynamic Host Configuration Protocol)</li> </ul>   |
| Transmission speed                         | 10 or 100 MBit/s  |
| Duplex modes                               | Half duplex, full duplex, auto-negotiation  |
| MDI modes (Medium Dependant Interface)     | Auto-MDIX   |
| Predefined standard objects                | Identity, Message Router, Assembly, Connection Manager, DLR, QoS, TCP/IP Interface, EtherNet Link object  |
| EDS file                                   | See <b>“Device Description Files”</b> on the website in the <b>Software chapter Type 8098</b> ▶   |
| <b>EtherCAT protocol<sup>1)</sup></b>      |   |
| Industrial Ethernet interface X1, X2       | X1: EtherCAT IN, X2: EtherCAT OUT   |
| Maximum number of cyclic input/output data | 512 bytes in total  |
| Maximum number of cyclic input data        | 1024 bytes  |
| Maximum number of cyclic output data       | 1024 bytes  |
| Acyclic communication (CoE)                | <ul style="list-style-type: none"> <li>• SDO</li> <li>• SDO master-slave</li> <li>• SDO slave-slave (depends on master capacity)</li> </ul>   |
| Type                                       | Complex slave   |
| Fieldbus Memory Management Units (FMMUs)   | 8   |
| Sync Managers                              | 4   |
| Transmission speed                         | 100 Mbit/s  |

### Approvals and Certificates

|               |   |
|---------------|---|
| Certification | <ul style="list-style-type: none"> <li>• PROFINET</li> <li>• EtherNet/IP</li> </ul> |
|---------------|---|

1.) EtherCAT® is a registered trademark and patented technology, licensed by Beckhoff Automation GmbH.

### 1.4. FLOWave S flowmeter

The FLOWave S flowmeter is available in two variants of the transmitter:

- Stainless steel transmitter without output and with stainless steel 5 pin M12 connector
- Stainless steel transmitter with 2 configurable outputs (DO/AO) and stainless steel 8 pin M12 connector.



### Product properties

#### Material

Detailed information on the materials can be found in chapter [“3.2. Material specifications”](#) on page 15.

#### Non wetted parts

|   |  |
|---|--|
| Transmitter housing, cover                      | Stainless steel 304/1.4301   |
| Light guide                                     | PC (Polycarbonate) and O-ring in EPDM (Ethylene Propylene Diene Monomer) |
| Seal between sensor and transmitter             | VMQ silicone (Methyl Vinyl Silicone)                                     |
| 5- or 8-pin M12 male connector and screwed plug | Stainless steel 316L/1.4404 or 303/1.4305                                |

| Weight (approx. in kg) | DN 08,<br>3/8", 1/2" | DN 15,<br>3/4" | DN 25,<br>1" | DN 40,<br>1 1/2" | DN 50,<br>2" | DN 65,<br>2 1/2" | DN 80,<br>3" |
|------------------------|----------------------|----------------|--------------|------------------|--------------|------------------|--------------|
| Clamp                  | 1.7                  | 1.6            | 1.8          | 2.6              | 2.8          | 5.0              | 5.1          |
| Flange                 | 1.9                  | 2.0            | 2.3          | 3.2              | 3.4          | –                | –            |
| Thread (dairy thread)  | –                    | –              | –            | –                | –            | 5.3              | 5.7          |

### Electrical data

|                   |  |
|-------------------|--|
| Power consumption | <ul style="list-style-type: none"> <li>• For device without output: max. 2.5 W</li> <li>• For device with 2 outputs (DO/AO): max. 5 W</li> </ul> |
|-------------------|--|

### Outputs

2, each configurable as digital or analogue output

Digital output

#### Only for device with 8-pin M12 connector

Overload information (through software diagnostics function)  
Transistor:

- Type: NPN or PNP (wiring dependent), open collector, galvanically isolated
- Operating modes: pulse (by default), On/Off, threshold, frequency (user configurable)
- 0...2 kHz, 5...35 V DC, max. 700 mA, max. pulse duration: 2 s, selectable limits: 0.0001...10000 pulses/litre or 0.0001...9999.99 litres/pulse

Analogue output

- Protected against polarity reversals of DC and overloads

Open loop detection (through software diagnostics function)  
Current:

- 4...20 mA
- 3.6 mA or 22 mA to indicate an error (only if 4...20 mA scale selected); galvanically isolated
- Max. loop impedance: 1300 Ω at 35 V DC, 1000 Ω at 30 V DC, 700 Ω at 24 V DC, 450 Ω at 18 V DC

### Process/Port connection & communication

|                       |  |
|-----------------------|--|
| Electrical connection | <ul style="list-style-type: none"> <li>• 1 × 5 pin M12 male fixed connector (A-coded) for device without output</li> <li>• 1 × 8 pin M12 male fixed connector (A-coded) for device with 2 outputs</li> </ul> |
|-----------------------|--|

**Data transfer**

- Device without output: external communication through būs (Bürkert system bus, CANopen protocol)
- Device with 2 outputs: būs connection only to the Bürkert Communicator for configuration and software update of the device. Due to the missing CAN shield the conventional būs/ CANopen communication is not recommended.

**Environment and installation****Ambient temperature**

Depends on the fluid temperature. Detailed information can be found in chapter **“5.1. Medium temperature”** on page 23.

**Operation**







- $-10...+70\text{ °C}$  ( $+14...+158\text{ °F}$ ) if  $-20\text{ °C}$  ( $4\text{ °F}$ )  $\leq$  fluid temperature  $\leq 80\text{ °C}$  ( $176\text{ °F}$ )
- The ambient temperature decreases linearly up to  $40\text{ °C}$  ( $104\text{ °F}$ ) at a fluid temperature of  $140\text{ °C}$  ( $284\text{ °F}$ ), if fluid temperature  $>80\text{ °C}$  ( $176\text{ °F}$ ),

## 2. Approvals

### Note:

- The certification/certificate listed below must be stated when making enquiries. This is the only way to ensure that the product complies with all required specifications.
- Not all available devices can be supplied with the certification/certificate below.

### 2.1. Certification

| Certificate   | Description   |
|---|---|
|                              | <b>EHEDG (Type EL - CLASS I)</b><br>The EHEDG compliance is only valid <ul style="list-style-type: none"> <li>• if the flowmeter with clamp connection according to DIN 32676 is used in combination with gaskets from Combifit International B.V.</li> <li>• if the flowmeter with threaded connection according to DIN 11851 is used in combination with gaskets from               <ul style="list-style-type: none"> <li>– 1. Kieselmann GmbH, Germany (ASEPTO-STAR k-flex upgrade gaskets) or</li> <li>– 2. Siersema Componenten Service (S.K.S.) B.V. (Netherlands SKS gasket set DIN 11851 EHEDG with EPDM or FKM inner gasket)</li> </ul> </li> </ul> |
|                              | <b>3-A Sanitary Standards</b><br>The 8098 meets sanitary standards for design and fabrication.<br>Certificate authorization number: 1178  |
|  Measuring Equipment E237737 | <b>UL-Listed for USA and Canada</b><br>Products are UL-listed products and comply also with the following standards: <ul style="list-style-type: none"> <li>• UL 61010-1</li> <li>• CAN/CSA-C22.2 No.61010-1</li> </ul> Certificate number: 2017-10-27-E237737  |
|                            | <b>LCIE 20 ATEX 1004 X</b><br><br>Specifications Ex <ul style="list-style-type: none"> <li>• II 3G Ex ec IIC T4 Gc</li> <li>• II 3D Ex tc IIIC T110 °C Dc or T130 °C Dc</li> </ul> Measures to comply with ATEX requirements: refer to the <b>Supplement ATEX Type 8098</b> ▶ under user manual. The Ex. certification is only valid if the Bürkert device is used as described in the supplement ATEX. If unauthorized changes are made to the device, the Ex. certification becomes invalid.  |
|                            | <b>PROFINET</b><br>Certificate number: Z12446   |
|                            | <b>EtherNet/IP</b><br>Document number: 11839  |

### 2.2. Certificates

| Certificate   | Description  |
|---|--|
| <b>FDA</b>  | The devices comply in their composition with the Code of Federal Regulations published by the FDA (Food and Drug Administration, USA). |
|  | EtherCAT® is a registered trademark and patented technology, licensed by Beckhoff Automation GmbH                                      |

### 2.3. Pressure Equipment Directive

The device conforms to Article 4, Paragraph 1 of the Pressure Equipment Directive 2014/68/EU under the following conditions:

#### Device used on a pipe

**Note:**

- The data in the table is independent of the chemical compatibility of the material and the fluid.
- PS = maximum admissible pressure, DN = nominal diameter of the pipe

| Type of fluid                              | Conditions   |
|--|--|
| Fluid group 1, Article 4, Paragraph 1.c.i  | $DN \leq 25$   |
| Fluid group 2, Article 4, Paragraph 1.c.i  | $DN \leq 32$ or $PS \cdot DN \leq 1000$                  |
| Fluid group 1, Article 4, Paragraph 1.c.ii | $DN \leq 25$ or $PS \cdot DN \leq 2000$                  |
| Fluid group 2, Article 4, Paragraph 1.c.ii | $DN \leq 200$ or $PS \leq 10$ or $PS \cdot DN \leq 5000$ |

## 3. Materials

### 3.1. Chemical Resistance Chart – Bürkert resistApp

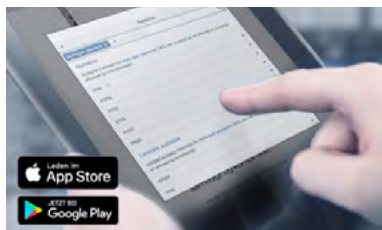

#### Bürkert resistApp – Chemical Resistance Chart

You want to ensure the reliability and durability of the materials in your individual application case? Verify your combination of media and materials on our website or in our resistApp.

[Start Chemical Resistance Check](#)

### 3.2. Material specifications

#### FLOWave L flowmeter without industrial communication

##### Note:

The following picture describes a device with 2 x M20 x 1.5 cable glands, 1 x 5 pin M12 male connector and clamp process connection.

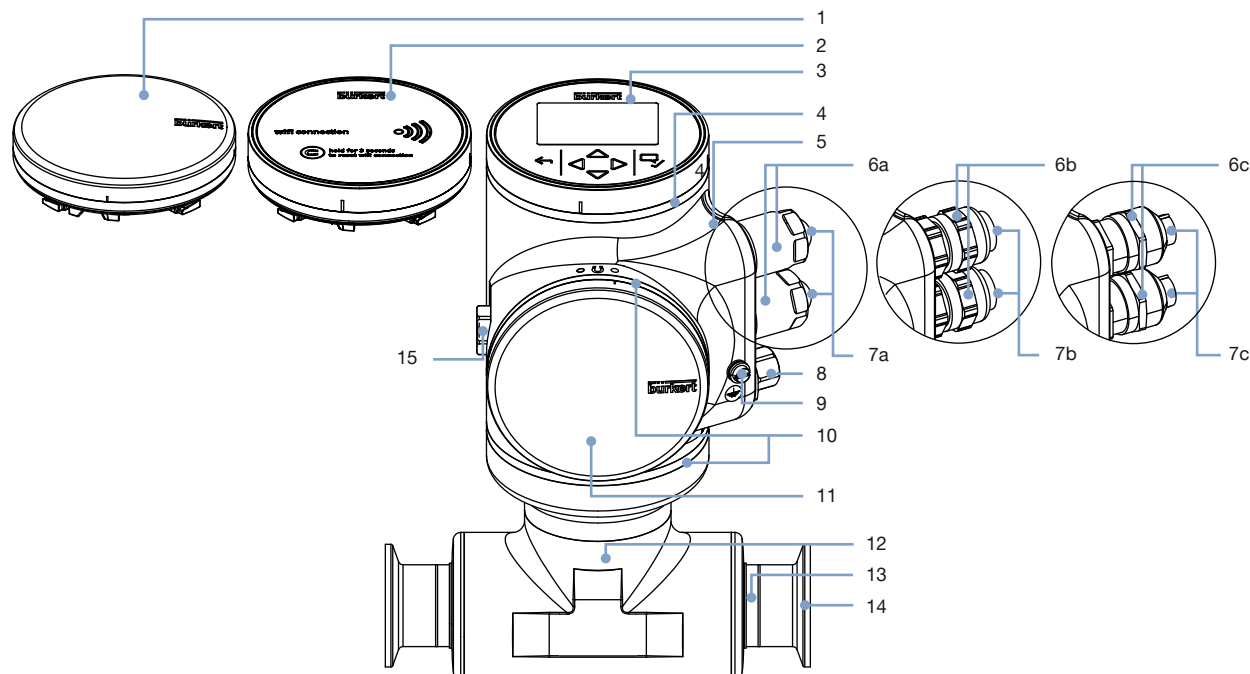

| No. | Description  | Material   |
|-----|--|--|
| 1   | Blind cover  | Stainless steel 304/1.4301   |
| 2   | Wi-Fi module   | Float glass, stainless steel 304/1.4301  |
| 3   | Display module   | Float glass, stainless steel 304/1.4301  |
| 4   | Multi-colour LED behind seal (used for e.g. to indicate the status of the product, based on the NAMUR NE 107 standard) | VMQ silicone   |
| 5   | Transmitter housing  | Stainless steel 304/1.4301   |
| 6a  | Cable glands (full stainless steel version)  | Stainless steel 304L/1.4307  |
| 6b  | Cable glands   | Nickel plated brass  |
| 6c  | Cable glands (ATEX version)  | Stainless steel 316L/1.4404  |
| 7a  | Blind plug (full stainless steel version)  | PA6  |
| 7b  | Blind plug   | Black POM  |
| 7c  | Blind plug (ATEX version)  | PA6  |
| 8   | 5 pin M12 male fixed connector (wired to bÜS) with screwed plug  | Stainless steel 316L/1.4404 (if equipped with 6a) or Nickel plated brass (if equipped with 6b)   |
| 9   | Functional earth   | Cylinder screw, washer, washer spring: stainless steel A4<br>blind rivet nut: stainless steel 1.4578/A4  |
| 10  | Seal   | VMQ silicone   |
| 11  | Blind cover  | Stainless steel 304/1.4301   |
| 12  | Sensor housing   | For sensor with process connection: <ul style="list-style-type: none"> <li>≤ DN 50/2": stainless steel 304/1.4301</li> <li>&gt; DN 50/2": stainless steel 316L/1.4435</li> </ul> |
| 13  | Sensor measurement tube  | Stainless steel 316L/1.4435 with low delta ferrite content   |
| 14  | Process connection (either clamp connections or flange connections)  | Stainless steel 316L/1.4435 with low delta ferrite content   |
| 15  | Pressure compensating element  | Diaphragm: ePTFE; support: polyester; O-ring: silicone 60 Shore A; body: stainless steel (316L/1.4404)   |

### FLOWave L flowmeter with industrial communication

#### Note:

The following picture describes a device (Ethernet version) with 2 × 4 pin M12 female connectors, 1 × 5 pin M12 male connector and flange process connection.

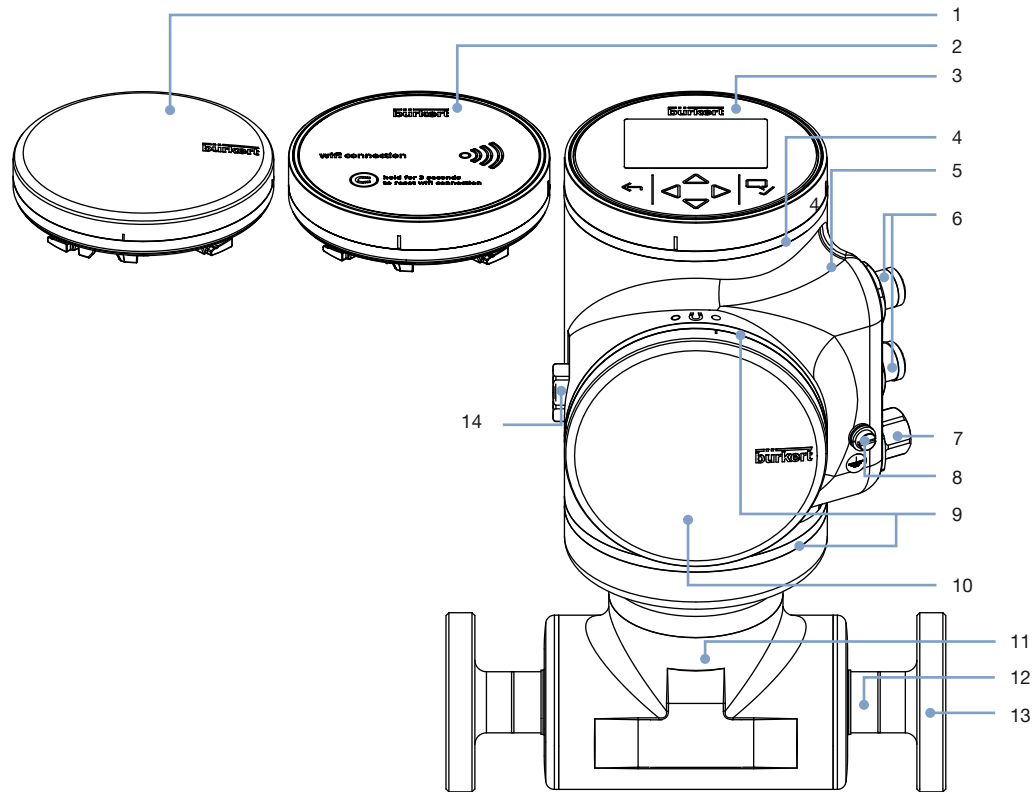

| No. | Description  | Material  |
|-----|--|---|
| 1   | Blind cover or   | Stainless steel 304/1.4301  |
| 2   | Wi-Fi module   | Float glass, stainless steel 304/1.4301   |
| 3   | Display module   | Float glass, stainless steel 304/1.4301   |
| 4   | Multi-colour LED behind seal (used for e.g. to indicate the status of the product, based on the NAMUR NE 107 standard) | VMQ silicone  |
| 5   | Transmitter housing  | Stainless steel 304/1.4301  |
| 6   | 4 pin M12 female fixed connectors with screwed plug  | Stainless steel 304L/1.4307   |
| 7   | 5 pin M12 male fixed connector (wired to bus) with screwed plug  | Stainless steel 316L/1.4404   |
| 8   | Functional earth   | Cylinder screw, washer, washer spring: stainless steel A4<br>blind rivet nut: stainless steel 1.4578/A4 |
| 9   | Blind cover  | VMQ silicone  |
| 10  | Seal   | Stainless steel 304/1.4301  |
| 11  | Sensor housing   | Stainless steel 304/1.4301 <sup>1.)</sup>   |
| 12  | Sensor measurement tube  | Stainless steel 316L/1.4435 with low delta ferrite content  |
| 13  | Process connection (either clamp connections or flange connections)  | Stainless steel 316L/1.4435 with low delta ferrite content  |
| 14  | Pressure compensating element  | Diaphragm: ePTFE; support: polyester; O-ring: silicone 60 Shore A; body: stainless steel (316L/1.4404)  |

1.) If instead of flange connections there are clamp connections according to DIN 32676 or threaded connections according to DIN 11851, the material of the sensor housing for DN > 50 is stainless steel 316L/1.4435.



**FLOWave S flowmeter**

**Note:**

The following picture shows a device with 1 × 5 pin M12 male connector and clamp process connection.

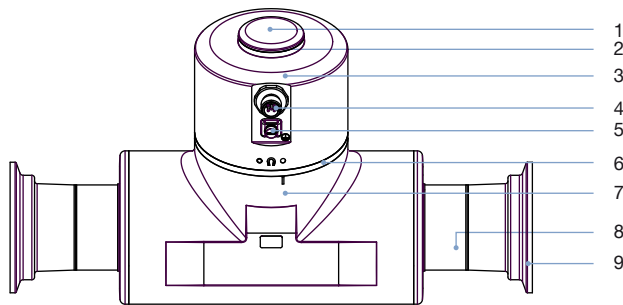

| No. | Description  | Material  |
|-----|--|---|
| 1   | Cover  | Stainless steel 304/1.4301  |
| 2   | Light guide for status display behind seal (used for e.g. indicating the status of the product, based on the NAMUR NE 107 standard)  | PC and O-ring in EPDM   |
| 3   | Transmitter housing  | Stainless steel 304/1.4301  |
| 4   | 5 pin M12 male fixed connector (wired to bus) with screwed plug or 8 pin M12 male fixed connector (wired to bus as service interface <sup>1.)</sup> and 2 x DO/AO) (with screwed plug) | Stainless steel 316L/1.4404 or 303/1.4305   |
| 5   | Functional earth   | Cylinder screw, washer, washer spring: stainless steel A4<br>blind rivet nut: stainless steel 1.4578/A4   |
| 6   | Seal   | VMQ silicone  |
| 7   | Sensor housing   | For sensor with process connection:<br><ul style="list-style-type: none"> <li>• ≤ DN 50/2": stainless steel 304/1.4301</li> <li>• &gt; DN 50/2": stainless steel 316L/1.4435</li> </ul> |
| 8   | Sensor measurement tube  | Stainless steel 316L/1.4435 with low delta ferrite content  |
| 9   | Process connection (either clamp connections or flange connections)  | Stainless steel 316L/1.4435 with low delta ferrite content  |

1.) bus connection only to the Bürkert communicator for configuration and software update of the device. Due to the missing CAN shield the conventional bus/ CANopen communication is not recommended.

## 4. Dimensions

### 4.1. Transmitter of the FLOWave L flowmeter without industrial communication

**Note:**

Specifications in mm

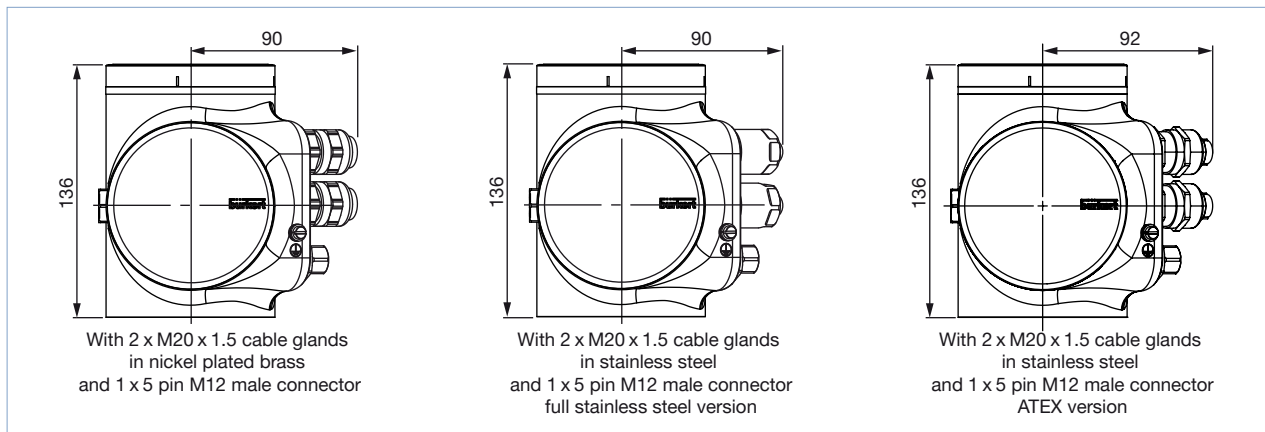

### 4.2. Transmitter of the FLOWave L flowmeter with industrial communication

**Note:**

Specifications in mm

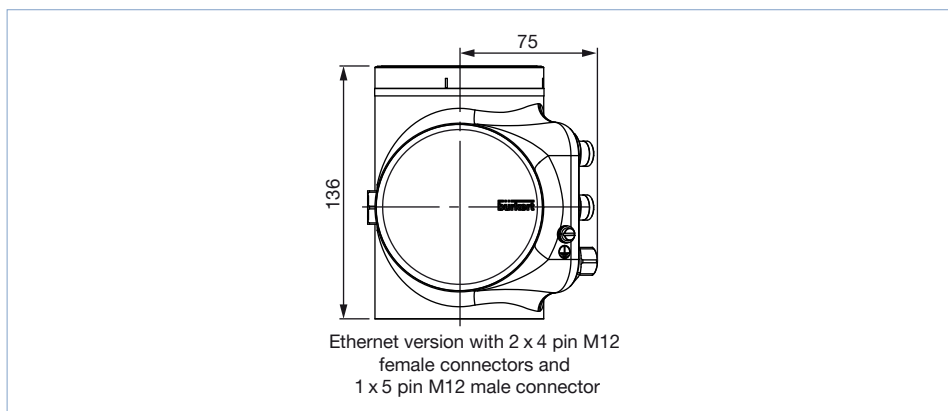

### 4.3. Transmitter of the FLOWave S flowmeter

**Note:**

Specifications in mm

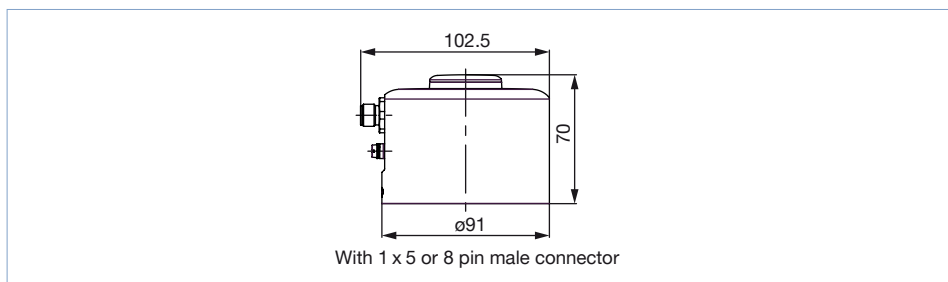

4.4. Flowmeter with clamp process connection

Note:

- Specifications in mm (unless specified differently)
- Clamp according to DIN 32676 series A, B or C, or SMS 3017

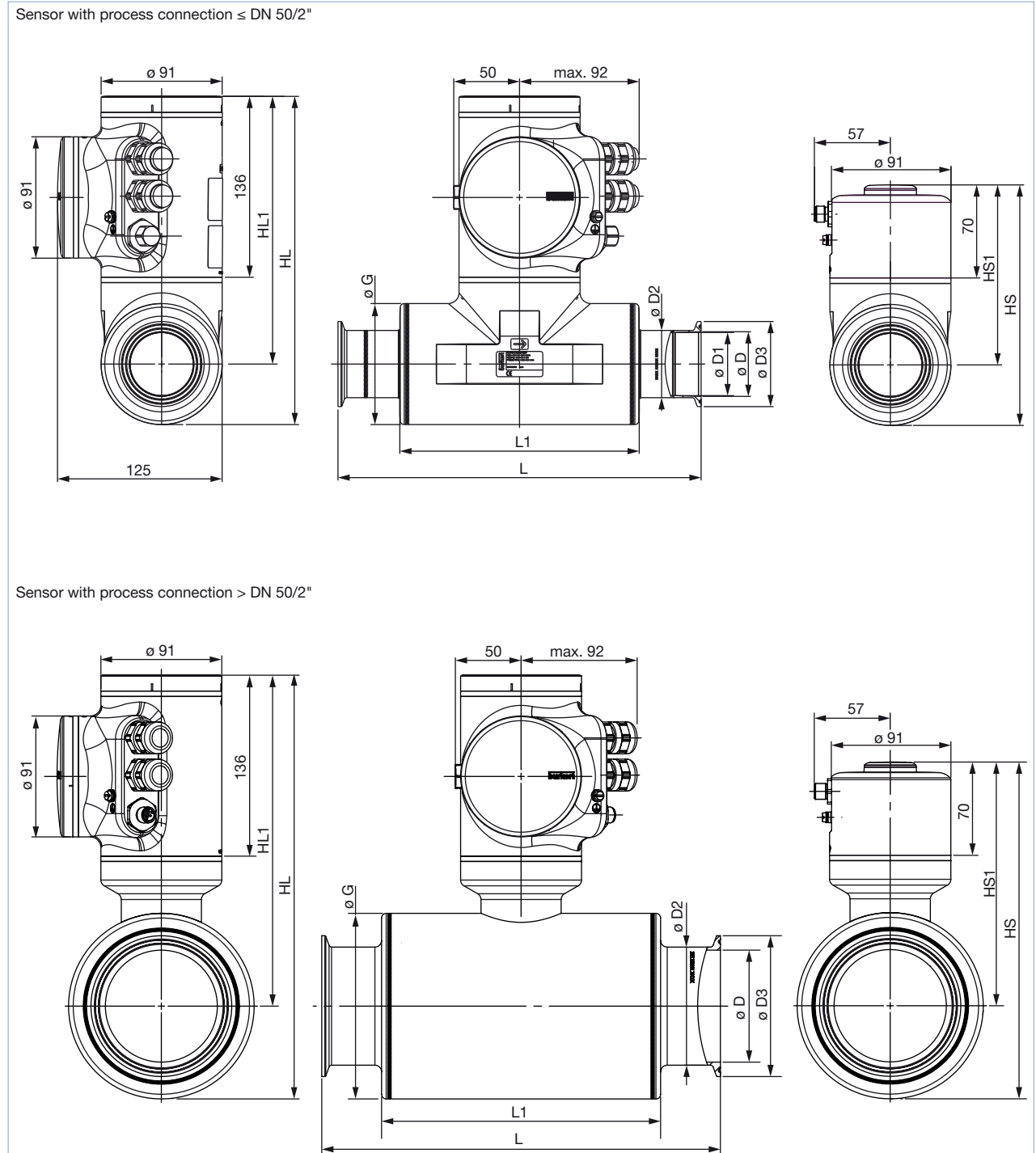

| Clamp/pipe size   |        |        |        |        |        |       |       |       |        |        |        |        |
|---|--------|--------|--------|--------|--------|-------|-------|-------|--------|--------|--------|--------|
| [mm]  | [inch] | HL     | HL1    | HS     | HS1    | D1    | D     | D2    | D3     | G      | L1     | L      |
| <b>Clamp according to DIN 32676 series A and process pipe according to DIN 11866 series A (DIN 11850)</b> |        |        |        |        |        |       |       |       |        |        |        |        |
| 08  | –      | 250.00 | 220.00 | 184.00 | 154.00 | 10.00 | 10.00 | 14.00 | 34.00  | 60.30  | 105.00 | 158.00 |
| 15 <sup>1.)</sup>   | –      | 250.00 | 220.00 | 184.00 | 154.00 | 15.75 | 16.00 | 19.05 | 34.00  | 60.30  | 105.00 | 166.00 |
| 25 <sup>1.)</sup>   | –      | 250.00 | 220.00 | 184.00 | 154.00 | 22.10 | 26.00 | 25.40 | 50.50  | 60.30  | 105.00 | 236.00 |
| 40 <sup>1.)</sup>   | –      | 250.00 | 200.00 | 184.00 | 134.00 | 34.80 | 38.00 | 38.10 | 50.50  | 91.00  | 180.00 | 326.00 |
| 50 <sup>1.)</sup>   | –      | 250.00 | 200.00 | 184.00 | 134.00 | 47.50 | 50.00 | 50.80 | 64.00  | 91.00  | 180.00 | 306.00 |
| 65  | –      | 321.00 | 251.00 | 255.00 | 185.00 | 66.00 | 66.00 | 70.00 | 91.00  | 139.70 | 210.00 | 300.00 |
| 80  | –      | 321.00 | 251.00 | 255.00 | 185.00 | 81.00 | 81.00 | 85.00 | 106.00 | 139.70 | 210.00 | 300.00 |
| <b>Clamp according to DIN 32676 series B and process pipe according to DIN 11866 series B (ISO 1127)</b>  |        |        |        |        |        |       |       |       |        |        |        |        |
| 08  | –      | 250.00 | 220.00 | 184.00 | 154.00 | 10.30 | 10.30 | 14.00 | 25.00  | 60.30  | 105.00 | 158.00 |
| 15  | –      | 250.00 | 220.00 | 184.00 | 154.00 | 18.10 | 18.10 | 21.30 | 50.50  | 60.30  | 105.00 | 168.00 |
| 15 <sup>2.)</sup>   | –      | 250.00 | 220.00 | 184.00 | 154.00 | 18.10 | 18.10 | 21.30 | 34.00  | 60.30  | 105.00 | 168.00 |
| 25  | –      | 250.00 | 220.00 | 184.00 | 154.00 | 29.70 | 29.70 | 33.70 | 50.50  | 60.30  | 120.00 | 175.00 |
| 40  | –      | 250.00 | 200.00 | 184.00 | 134.00 | 44.30 | 44.30 | 48.30 | 64.00  | 91.00  | 180.00 | 273.00 |
| 50  | –      | 250.00 | 200.00 | 184.00 | 134.00 | 56.30 | 56.30 | 60.30 | 77.50  | 91.00  | 180.00 | 273.00 |
| 65  | –      | 321.00 | 251.00 | 255.00 | 185.00 | 72.10 | 72.10 | 76.10 | 91.00  | 139.70 | 210.00 | 300.00 |
| 80  | –      | 321.00 | 251.00 | 255.00 | 185.00 | 84.30 | 84.30 | 88.90 | 106.00 | 139.70 | 210.00 | 300.00 |
| <b>Clamp according to DIN 32676 series C and process pipe according to DIN 11866 series C (ASME BPE)</b>  |        |        |        |        |        |       |       |       |        |        |        |        |
| –   | ¾      | 250.00 | 220.00 | 184.00 | 154.00 | 7.75  | 7.75  | 14.00 | 25.00  | 60.30  | 105.00 | 158.00 |
| –   | ½      | 250.00 | 220.00 | 184.00 | 154.00 | 9.40  | 9.40  | 14.00 | 25.00  | 60.30  | 105.00 | 158.00 |
| –   | ¾      | 250.00 | 220.00 | 184.00 | 154.00 | 15.75 | 15.75 | 19.05 | 25.00  | 60.30  | 105.00 | 143.00 |
| –   | 1      | 250.00 | 220.00 | 184.00 | 154.00 | 22.10 | 22.10 | 25.40 | 50.50  | 60.30  | 105.00 | 143.00 |
| –   | 1½     | 250.00 | 200.00 | 184.00 | 134.00 | 34.80 | 34.80 | 38.10 | 50.50  | 91.00  | 180.00 | 273.00 |
| –   | 2      | 250.00 | 200.00 | 184.00 | 134.00 | 47.50 | 47.50 | 50.80 | 64.00  | 91.00  | 180.00 | 273.00 |
| –   | 2½     | 321.00 | 251.00 | 255.00 | 185.00 | 60.20 | 60.20 | 63.50 | 77.50  | 139.70 | 210.00 | 300.00 |
| –   | 3      | 321.00 | 251.00 | 255.00 | 185.00 | 72.90 | 72.90 | 76.20 | 91.00  | 139.70 | 210.00 | 300.00 |
| <b>Clamp according to SMS 3017 and process pipe according to SMS 3008</b>                                 |        |        |        |        |        |       |       |       |        |        |        |        |
| 25 <sup>1.)</sup>   | –      | 250.00 | 220.00 | 184.00 | 154.00 | 22.10 | 22.60 | 25.40 | 50.50  | 60.30  | 105.00 | 143.00 |
| 40 <sup>1.)</sup>   | –      | 250.00 | 200.00 | 184.00 | 134.00 | 34.80 | 35.60 | 38.10 | 50.50  | 91.00  | 180.00 | 273.00 |
| 50 <sup>1.)</sup>   | –      | 250.00 | 200.00 | 184.00 | 134.00 | 47.50 | 48.60 | 50.80 | 64.00  | 91.00  | 180.00 | 273.00 |

1.) DIN 32676 series A and SMS 3017 based on ASME BPE pipe dimension with adapted concentric clamp design

Design according to EHEDG DOC8 guidelines

2.) Similar to DIN 32676 series B but with clamp 34.0

### 4.5. Flowmeter with aseptic collar flange (BF)

**Note:**

- Specifications in mm (unless specified differently)
- Aseptic collar flange (BF) according to DIN 11864-2 form A series A, B or C

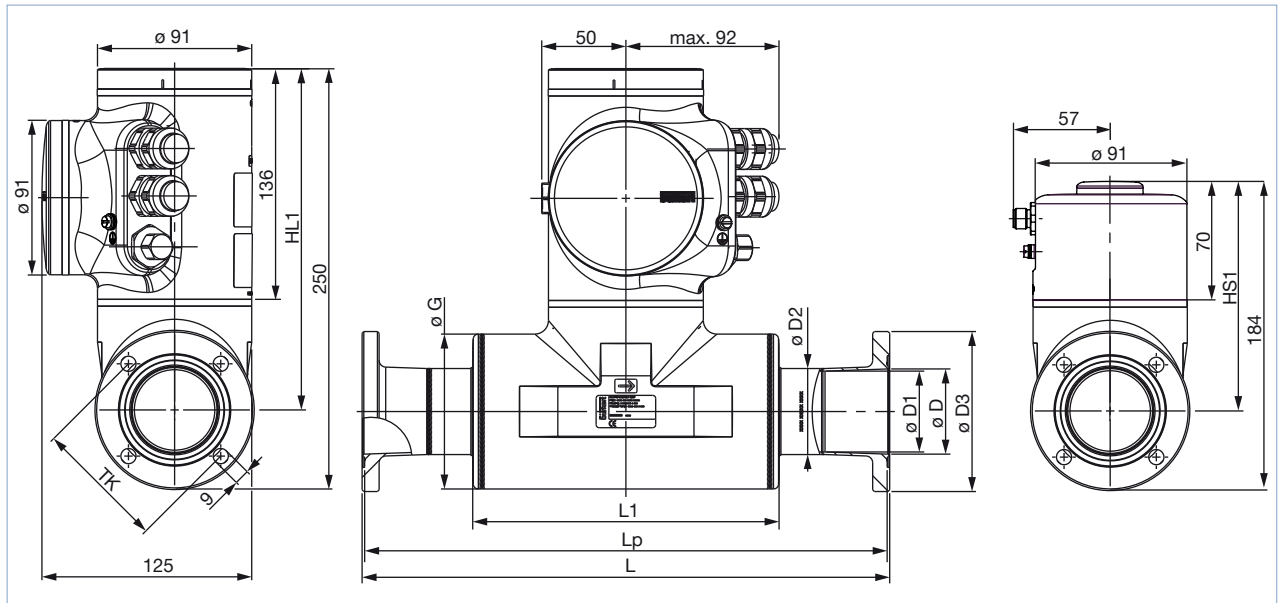

| Flange/pipe size   |        |        |        |       |       |       |       |        |       |        |        |        |
|--|--------|--------|--------|-------|-------|-------|-------|--------|-------|--------|--------|--------|
| [mm]   | [inch] | HL1    | HS1    | TK    | D1    | D     | D2    | D3     | G     | L1     | Lp     | L      |
| <b>Flange according to DIN 11864-2 series A and process pipe according to DIN 11866 series A (DIN 11850)</b> |        |        |        |       |       |       |       |        |       |        |        |        |
| 15 <sup>1.)</sup>  | –      | 220.00 | 154.00 | 42.00 | 15.75 | 16.00 | 19.05 | 59.00  | 60.30 | 105.00 | 163.00 | 166.00 |
| 25 <sup>1.)</sup>  | –      | 220.00 | 154.00 | 53.00 | 22.10 | 26.00 | 25.40 | 70.00  | 60.30 | 105.00 | 237.00 | 240.00 |
| 40 <sup>1.)</sup>  | –      | 200.00 | 134.00 | 65.00 | 34.80 | 38.00 | 38.10 | 82.00  | 91.00 | 180.00 | 327.00 | 330.00 |
| 50 <sup>1.)</sup>  | –      | 200.00 | 134.00 | 77.00 | 47.50 | 50.00 | 50.80 | 94.00  | 91.00 | 180.00 | 307.00 | 310.00 |
| <b>Flange according to DIN 11864-2 series B and process pipe according to DIN 11866 series B (ISO 1127)</b>  |        |        |        |       |       |       |       |        |       |        |        |        |
| 08   | –      | 220.00 | 154.00 | 37.00 | 10.30 | 10.30 | 14.00 | 54.00  | 60.30 | 105.00 | 155.00 | 158.00 |
| 15   | –      | 220.00 | 154.00 | 45.00 | 18.10 | 18.10 | 21.30 | 62.00  | 60.30 | 105.00 | 170.00 | 173.00 |
| 25   | –      | 220.00 | 154.00 | 57.00 | 29.70 | 29.70 | 33.70 | 74.00  | 60.30 | 120.00 | 187.00 | 190.00 |
| 40   | –      | 200.00 | 134.00 | 71.00 | 44.30 | 44.30 | 48.30 | 88.00  | 91.00 | 180.00 | 275.00 | 278.00 |
| 50   | –      | 200.00 | 134.00 | 85.00 | 56.30 | 56.30 | 60.30 | 103.00 | 91.00 | 180.00 | 262.00 | 265.00 |
| <b>Flange according to DIN 11864-2 series C and process pipe according to DIN 11866 series C (ASME BPE)</b>  |        |        |        |       |       |       |       |        |       |        |        |        |
| –  | ½      | 220.00 | 154.00 | 37.00 | 9.40  | 9.40  | 14.00 | 54.00  | 60.30 | 105.00 | 155.00 | 158.00 |
| –  | ¾      | 220.00 | 154.00 | 42.00 | 15.75 | 15.75 | 19.05 | 59.00  | 60.30 | 105.00 | 168.00 | 171.00 |
| –  | 1      | 220.00 | 154.00 | 49.00 | 22.10 | 22.10 | 25.40 | 66.00  | 60.30 | 105.00 | 165.00 | 168.00 |
| –  | 1½     | 200.00 | 134.00 | 62.00 | 34.80 | 34.80 | 38.10 | 79.00  | 91.00 | 180.00 | 275.00 | 278.00 |
| –  | 2      | 200.00 | 134.00 | 75.00 | 47.50 | 47.50 | 50.80 | 92.00  | 91.00 | 180.00 | 275.00 | 278.00 |

1.) DIN 11864-2 series A based on ASME BPE pipe dimension with adapted concentric clamp design  
 Design according to EHEDG DOC8 guidelines

DTS 1000270652 EN Version: P Status: RL (released | freigegeben | valide) printed: 30.04.2021

#### 4.6. Flowmeter with aseptic collar clamp (BKS)

**Note:**

- Specifications in mm (unless specified differently)
- Aseptic collar clamp (BKS) according to DIN 11864-3 form A series A, B or C

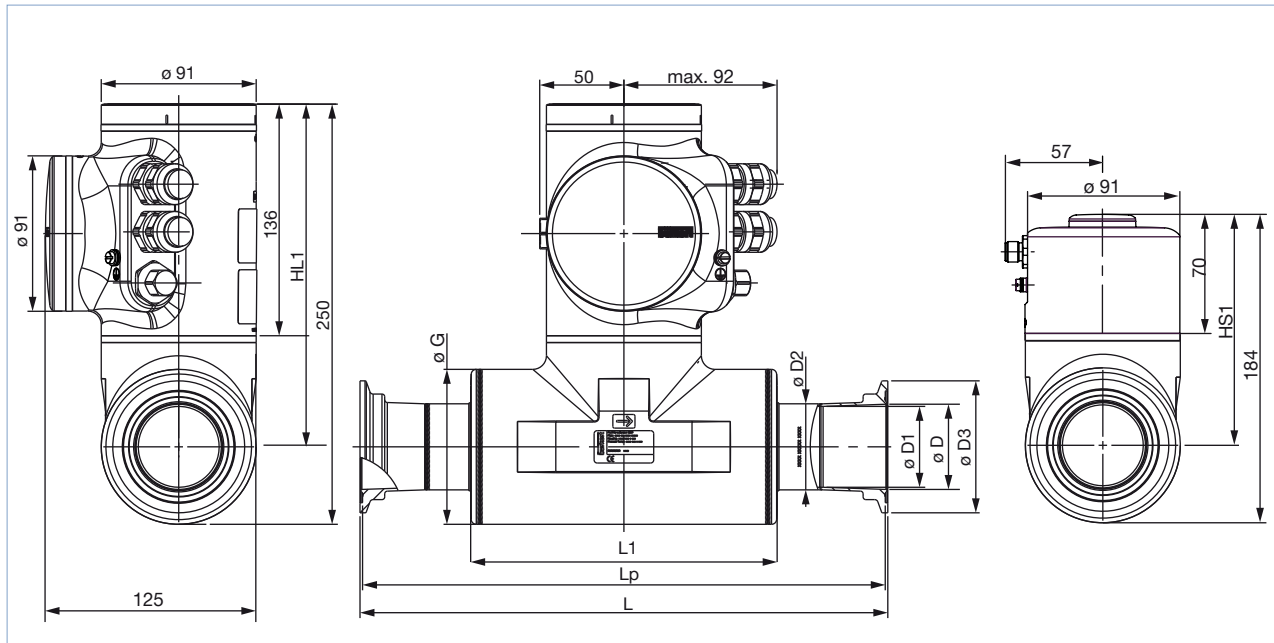

| Clamp/pipe size   |        |        |        |       |       |       |       |       |        |        |        |
|---|--------|--------|--------|-------|-------|-------|-------|-------|--------|--------|--------|
| [mm]  | [inch] | HL1    | HS1    | D1    | D     | D2    | D3    | G     | L1     | Lp     | L      |
| <b>Clamp according to DIN 11864-3 series A and process pipe according to DIN 11866 series A (DIN 11850)</b> |        |        |        |       |       |       |       |       |        |        |        |
| 15 <sup>1.)</sup>   | -      | 220.00 | 154.00 | 15.75 | 16.00 | 19.05 | 34.00 | 60.30 | 105.00 | 163.00 | 166.00 |
| 25 <sup>1.)</sup>   | -      | 220.00 | 154.00 | 22.10 | 26.00 | 25.40 | 50.50 | 60.30 | 105.00 | 237.00 | 240.00 |
| 40 <sup>1.)</sup>   | -      | 200.00 | 134.00 | 34.80 | 38.00 | 38.10 | 64.00 | 91.00 | 180.00 | 327.00 | 330.00 |
| 50 <sup>1.)</sup>   | -      | 200.00 | 134.00 | 47.50 | 50.00 | 50.80 | 77.50 | 91.00 | 180.00 | 307.00 | 310.00 |
| <b>Clamp according to DIN 11864-3 series B and process pipe according to DIN 11866 series B (ISO 1127)</b>  |        |        |        |       |       |       |       |       |        |        |        |
| 08  | -      | 220.00 | 154.00 | 10.30 | 10.30 | 14.00 | 34.00 | 60.30 | 105.00 | 155.00 | 158.00 |
| 15  | -      | 220.00 | 154.00 | 18.10 | 18.10 | 21.30 | 34.00 | 60.30 | 105.00 | 166.00 | 169.00 |
| 25  | -      | 220.00 | 154.00 | 29.70 | 29.70 | 33.70 | 50.50 | 60.30 | 120.00 | 187.00 | 190.00 |
| 40  | -      | 200.00 | 134.00 | 44.30 | 44.30 | 48.30 | 64.00 | 91.00 | 180.00 | 277.00 | 280.00 |
| 50  | -      | 200.00 | 134.00 | 56.30 | 56.30 | 60.30 | 91.00 | 91.00 | 180.00 | 268.00 | 271.00 |
| <b>Clamp according to DIN 11864-3 series C and process pipe according to DIN 11866 series C (ASME BPE)</b>  |        |        |        |       |       |       |       |       |        |        |        |
| -   | ½      | 220.00 | 154.00 | 9.40  | 9.40  | 14.00 | 34.00 | 60.30 | 105.00 | 155.00 | 158.00 |
| -   | ¾      | 220.00 | 154.00 | 15.75 | 15.75 | 19.05 | 34.00 | 60.30 | 105.00 | 164.00 | 167.00 |
| -   | 1      | 220.00 | 154.00 | 22.10 | 22.10 | 25.40 | 50.50 | 60.30 | 105.00 | 161.00 | 164.00 |
| -   | 1½     | 200.00 | 134.00 | 34.80 | 34.80 | 38.10 | 64.00 | 91.00 | 180.00 | 275.00 | 278.00 |
| -   | 2      | 200.00 | 134.00 | 47.50 | 47.50 | 50.80 | 77.50 | 91.00 | 180.00 | 276.00 | 279.00 |

1.) DIN 11864-3 series A based on ASME BPE pipe dimension with adapted concentric clamp design  
Design according to EHEDG DOC8 guidelines

### 4.7. Flowmeter with thread connection

**Note:**

- Specifications in mm (unless specified differently)
- Thread connection according to DIN 11851 series A

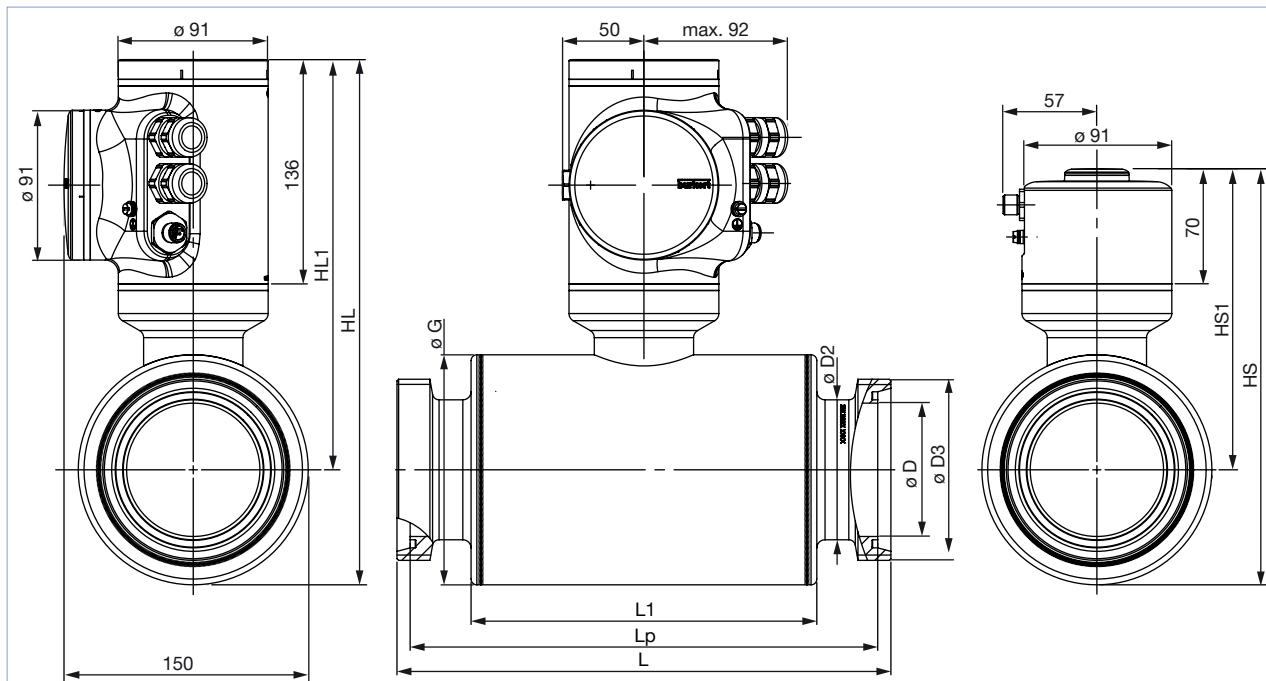

| Thread/pipe size              |        |        |        |        |       |       |                   |        |        |        |        |  |
|-------------------------------|--------|--------|--------|--------|-------|-------|-------------------|--------|--------|--------|--------|--|
| [mm]                          | HL     | HL1    | HS     | HS1    | D     | D2    | D3 <sup>1.)</sup> | G      | L1     | Lp     | L      |  |
| Thread according to DIN 11851 |        |        |        |        |       |       |                   |        |        |        |        |  |
| 65                            | 321.00 | 251.00 | 255.00 | 185.00 | 66.00 | 70.00 | Rd 95 x 1/6       | 139.70 | 210.00 | 284.00 | 300.00 |  |
| 80                            | 321.00 | 251.00 | 255.00 | 185.00 | 81.00 | 85.00 | Rd 110 x 1/4      | 139.70 | 210.00 | 284.00 | 300.00 |  |

1.) Thread according to DIN 405-1

## 5. Performance specifications

### 5.1. Medium temperature

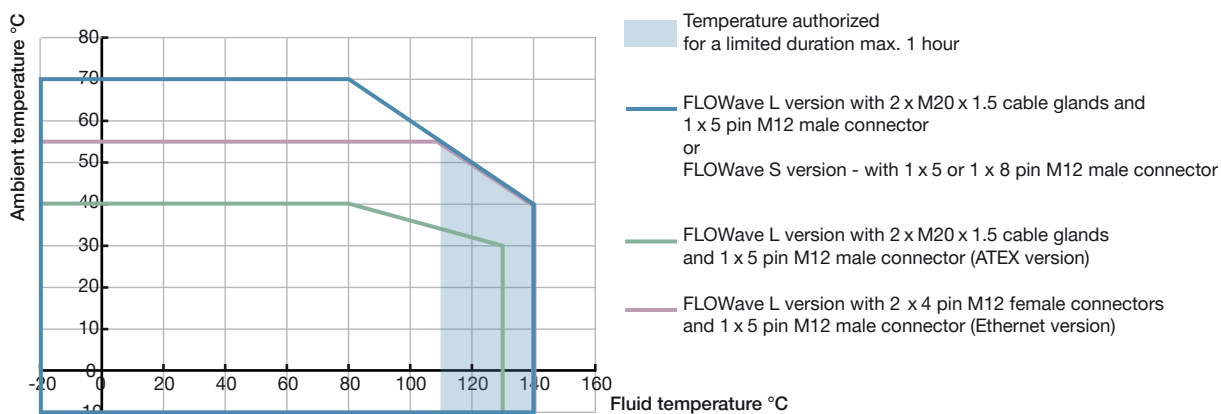

DTS 1000270652 EN Version: P Status: RL (released | freigegeben | valide) printed: 30.04.2021

## 5.2. Measurement deviation

### Note:

This table shows the measurement deviations according to the pipe connection standards per measuring range.

| DN                    | Pipe standard                                 | Flow velocity<br>in sensor tube [m/s] | 0.1                             | 1                                 | 10  |
|-----------------------|---|---------------------------------------|---------------------------------|-----------------------------------|-----|
| ⅝"                    | ASME BPE                                      | Volume flow rate range [m³/h]         | 0.017<br>± 0.08 % of full scale | 0.17<br>± 0.4 % of measured value | 1.7 |
| ½"                    | ASME BPE                                      | Volume flow rate range [m³/h]         | 0.025<br>± 0.08 % of full scale | 0.25<br>± 0.4 % of measured value | 2.5 |
| 08                    | ISO 1127<br>DIN 11850                         | Volume flow rate range [m³/h]         | 0.03<br>± 0.08 % of full scale  | 0.30<br>± 0.4 % of measured value | 3   |
| ¾"<br>15              | ASME BPE<br>DIN 11850                         | Volume flow rate range [m³/h]         | 0.07<br>± 0.08 % of full scale  | 0.7<br>± 0.4 % of measured value  | 7   |
| 15                    | ISO 1127                                      | Volume flow rate range [m³/h]         | 0.10<br>± 0.08 % of full scale  | 1.0<br>± 0.4 % of measured value  | 10  |
| 1"<br>25<br>25<br>25  | ASME BPE<br>DIN 11850<br>SMS 3008<br>ISO 1127 | Volume flow rate range [m³/h]         | 0.14<br>± 0.08 % of full scale  | 1.4<br>± 0.4 % of measured value  | 14  |
| 25                    | ISO 1127                                      | Volume flow rate range [m³/h]         | 0.25<br>± 0.08 % of full scale  | 2.5<br>± 0.4 % of measured value  | 25  |
| 1½"<br>40<br>40<br>40 | ASME BPE<br>DIN 11850<br>SMS 3008<br>ISO 1127 | Volume flow rate range [m³/h]         | 0.35<br>± 0.08 % of full scale  | 3.5<br>± 0.4 % of measured value  | 35  |
| 40                    | ISO 1127                                      | Volume flow rate range [m³/h]         | 0.56<br>± 0.08 % of full scale  | 5.6<br>± 0.4 % of measured value  | 56  |
| 2"<br>50<br>50<br>50  | ASME BPE<br>DIN 11850<br>SMS 3008<br>ISO 1127 | Volume flow rate range [m³/h]         | 0.64<br>± 0.08 % of full scale  | 6.4<br>± 0.4 % of measured value  | 64  |
| 50                    | ISO 1127                                      | Volume flow rate range [m³/h]         | 0.90<br>± 0.08 % of full scale  | 9.0<br>± 0.4 % of measured value  | 90  |
| 2½"                   | ASME BPE                                      | Volume flow rate range [m³/h]         | 1.02<br>± 0.08 % of full scale  | 10.2<br>± 0.4 % of measured value | 102 |
| 65                    | DIN 11850                                     | Volume flow rate range [m³/h]         | 1.23<br>± 0.08 % of full scale  | 12.3<br>± 0.4 % of measured value | 123 |
| 65                    | ISO 1127                                      | Volume flow rate range [m³/h]         | 1.47<br>± 0.08 % of full scale  | 14.7<br>± 0.4 % of measured value | 147 |
| 3"                    | ASME BPE                                      | Volume flow rate range [m³/h]         | 1.50<br>± 0.08 % of full scale  | 15.0<br>± 0.4 % of measured value | 150 |
| 80                    | DIN 11850                                     | Volume flow rate range [m³/h]         | 1.85<br>± 0.08 % of full scale  | 18.5<br>± 0.4 % of measured value | 185 |
| 80                    | ISO 1127                                      | Volume flow rate range [m³/h]         | 2.00<br>± 0.08 % of full scale  | 20.0<br>± 0.4 % of measured value | 200 |



## 6. Product installation

### 6.1. Installation notes

**Note:**

The flowmeter is not designed for gas and steam flow measurement. However, their flow does not have any negative effect on the device or its operation. Other liquids flowing through again afterwards are measured correctly as before.

The factory calibration of the FLOWave is done under reference conditions with inlet (40xDN) and outlet (1 xDN) distances and the appropriate internal diameter of the pipes.

Deviation from reference conditions can be easily adjusted through the use of a built-in K factor adjustment or Teach in procedure. We can support you if necessary, please do not hesitate to contact us.

The device can be installed into either horizontal, oblique or vertical pipes. But an installation on a vertical pipe will be better to prevent air or gas bubbles inside the measurement area. **For proper operation always ensure a totally filled measurement tube.**

Conformity to 3A and EHEDG requires an angle of at least 5° (for SMS or series A connections) or 3° (all others available connections) against horizontal to ensure complete draining however this not necessary for proper operation of the FLOWave.

The suitable pipe size can be selected using the diagram for selecting the nominal diameter of the pipe. See chapter "6.2. Selection of the nominal diameter" on page 25.

### 6.2. Selection of the nominal diameter

The graph is used to determine the DN of the pipe and the flowmeter appropriate to the application, according to the fluid velocity and the flow rate. On the chart, the intersection of flow rate and flow velocity gives the appropriate diameter.

**Example 1:**

Flowmeter with process connection according to DIN 32676 series B (pipe ISO 1127) or DIN 11864-2 form A series B (pipe ISO 1127)

- Flow: 10 m³/h
  - Optimal flow rate: 1...3 m/s
- Result: Select a pipe size of DN 40 or DN 50

**Example 2:**

Flowmeter with process connection according to DIN 32676 series A (pipe DIN 11850) or DIN 11864-2 series A (pipe DIN 11850)

- Flow: 10 m³/h
  - Optimal flow rate: 1...3 m/s
- Result: Select a pipe size of DN 40 or DN 50

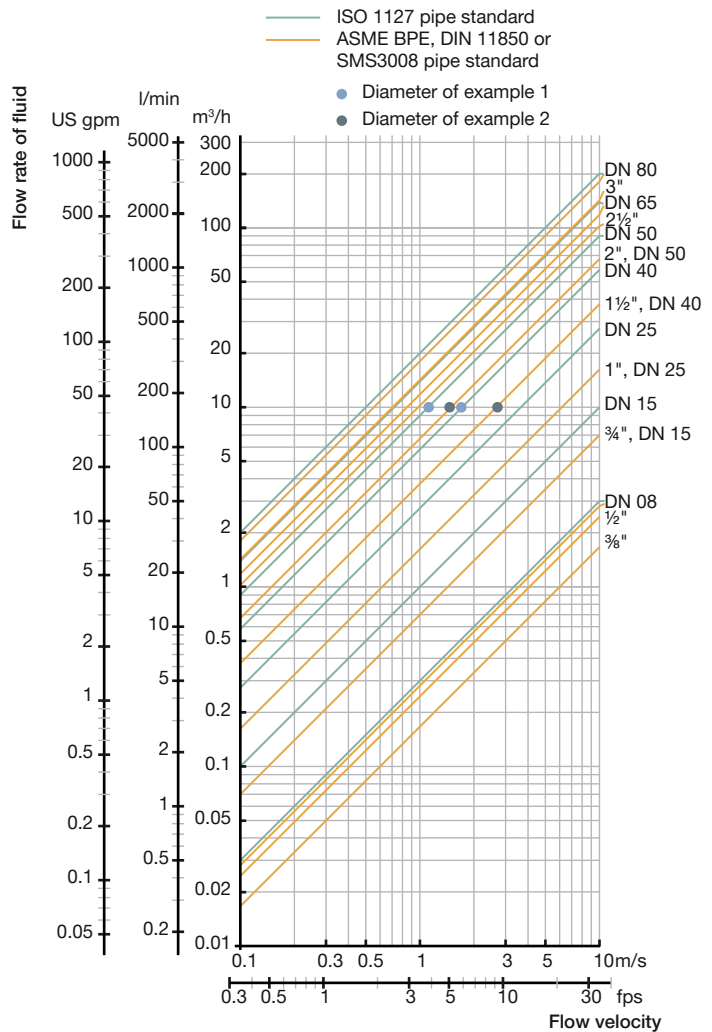

### 6.3. Mounting options

#### FLOWave L flowmeter

The product is delivered as described in position 1 in the picture below. The position of the transmitter can be changed in 90° steps. The position of the display module and the blind cover can also be changed in steps of 90° both on the top of the unit and on the front face.

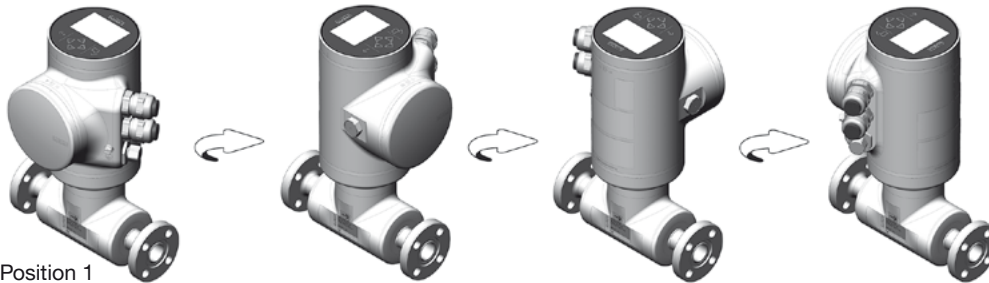

Position 1

For safety reasons the display module and blind cover on the top or front are locked. The display module and blind cover can be unlocked with a magnetic key which is included in the delivery of each device.

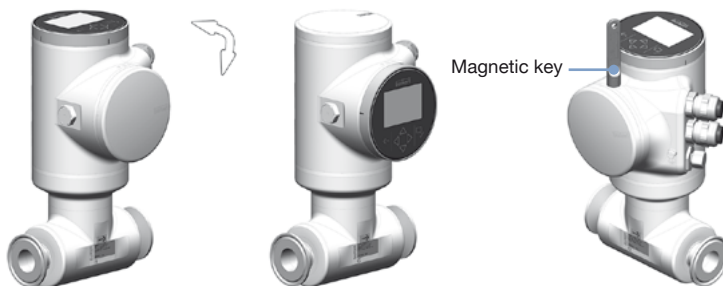

#### FLOWave S flowmeter

The product is delivered as described in position 1 in the picture below. The position of the transmitter can be changed in 90° steps. For safety reasons the transmitter is locked. The transmitter can be unlocked with a magnetic key which is included in the delivery of each device.



Position 1

## 7. Product operation

### 7.1. Measuring principle

The technology used is based on SAW (Surface Acoustic Waves). The type of wave propagation is similar to what happens when an earthquake occurs in nature.

In the case of FLOWave it is a miniaturized signal, not running on the surface of the earth but on a measurement tube. FLOWave uses so called interdigital transducers which are placed on flattened areas of the tube surface. Each one acts as emitter as well as receiver. Two of them (nos. 1 and 4) emit forward, in the direction of the liquid flow, the others (nos. 2 and 3) backwards, i.e. in the opposite direction to the direction of flow. The propagation time is measured from emitter to receiver. The difference between the forward and backward propagation time of the waves is proportional to the volume flow rate.

The high performance measurement is based on:

- Each emitter creates multiple receiving signals at two other receivers
- The results are based on the reception of the signals that pass through the liquid one or more times.
- Several measurements can be performed based on the collected information. Many properties of the liquid can be derived, including the flow velocity, the fraction of the transmitted signal (“acoustic transmission factor”), and the so-called “density factor” (see below), as well as information about the presence of gas bubbles or solid parts.

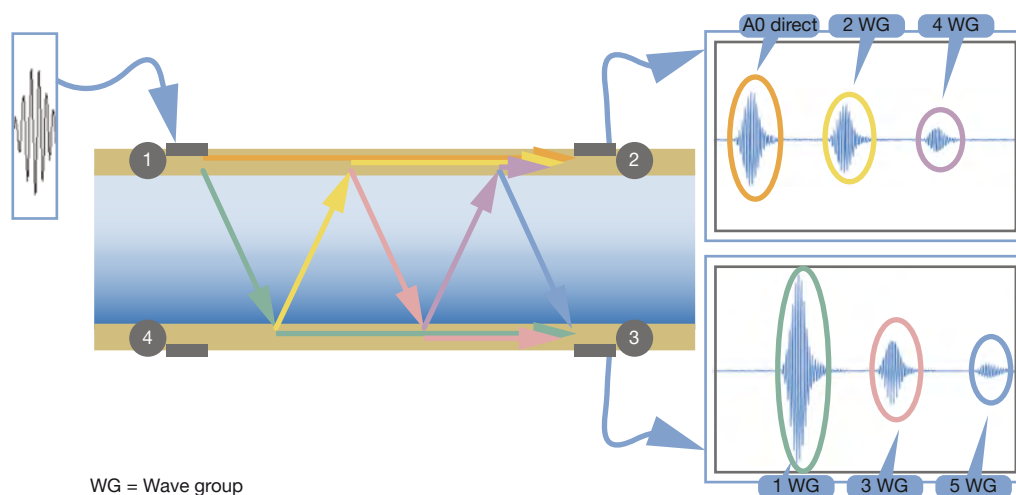

This figure shows, as an example, the reception signals when interdigital transducer 1 is transmitting. The emitter excitation produces the SAW with a frequency of more than 1 MHz.

As a result of the emission of these waves, the following effects occur:

- A wave propagates along the surface of the tube (see orange line).
- A wave is emitted (see green line) and passes through the liquid towards the opposite side of the tube at a certain angle, which depends mainly on the speed of propagation on the surface of the tube and in the liquid.
- Upon reaching the opposite side of the tube, two effects take place.
  - A wave is triggered in the tube and propagates (see green line) to receiver 3
  - A wave is triggered in the liquid (see yellow line) and passes through it again to the opposite wall of the tube.

These effects get repeated at each reflection, resulting in all the different colour-coded signals indicated in the figure.

### 7.2. Special functions

For the detection of gas bubbles and solid particles the device (from firmware version 01.05.00) includes a so called “acoustic transmission factor” with a measurement range of 5...120 %. The value of this is continuously measured and is directly dependent on gas bubbles and solids in a fluid.

A “density factor”, with a measuring range of 0.8...1.3, is available for the detection and differentiation of liquids. This continuously measured value, which uses water as reference fluid, is temperature-compensated and so its value is representative in a tight value range for each liquid. The changes in value of this process measurement enable differentiation between different liquids.

## 8. Product design and assembly

### 8.1. Product assembly

The 8098 flowmeter consists of a S097 flow sensor and a SE98 transmitter (FLOWave L flowmeter) or SE91 transmitter (FLOWave S flowmeter).

The flow sensor includes the measurement tube equipped with interdigital transducers, the sensor housing and the process connections in accordance to the standards ISO, ASME BPE, DIN, SMS. At present the sensor size ranges from DN 08 to DN 80 or from 3/8" to 3".

The FLOWave L flowmeter is available with or without display. The high resolution display includes a capacitive working keypad for all interactive user actions, guided by a user friendly menu system. The output signals include one analogue output and one digital output; while a third output signal can be switched between analogue and digital through parametrisation. Electrical connection is done on push-in connectors via two cable glands and/or one M12 connector.

The FLOWave S flowmeter is only available without display. The electrical connection is made via an M12 connector.

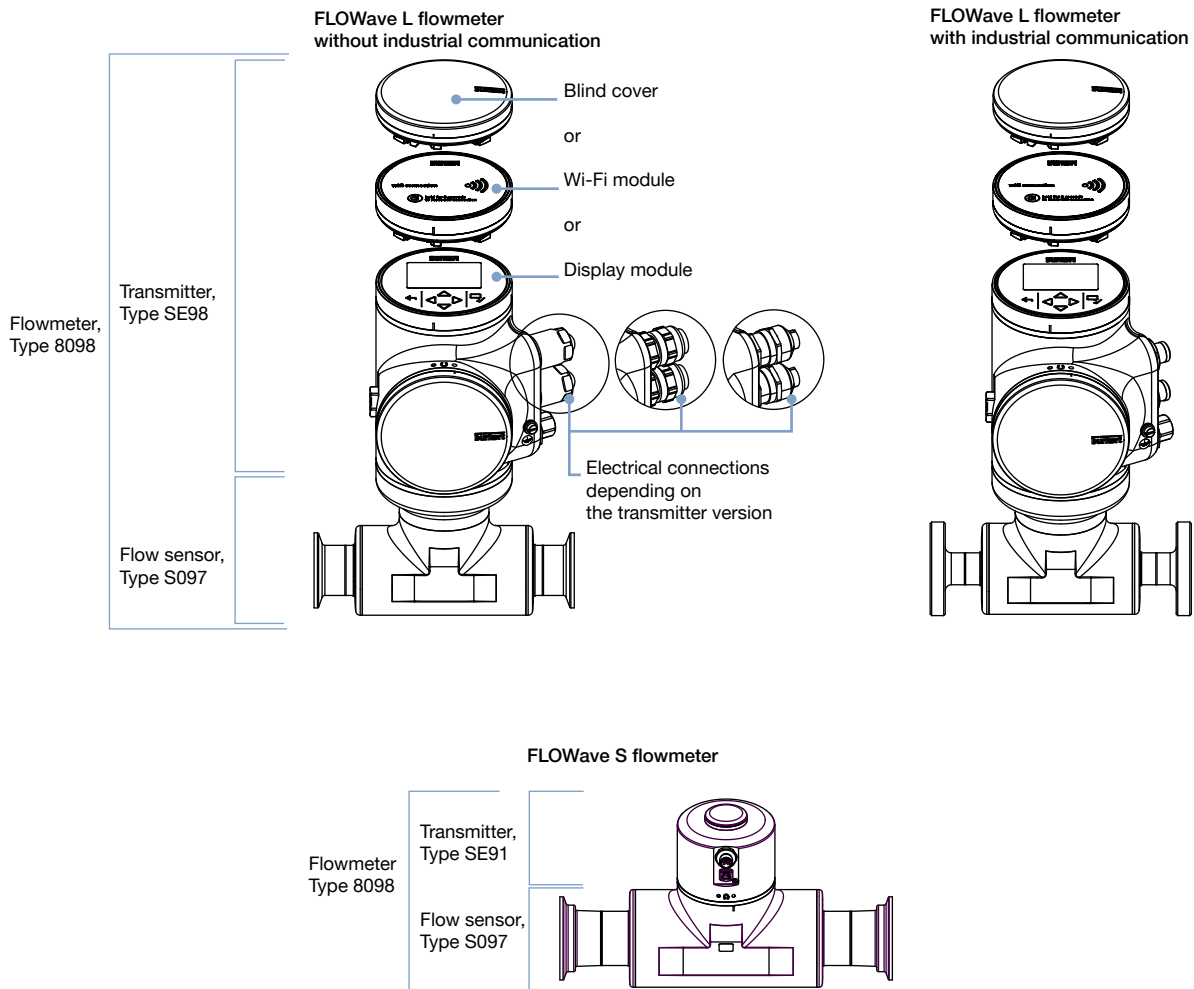

DTS 1000270652 EN Version: P Status: RL (released | freigegeben | validé) printed: 30.04.2021

## 9. Product accessories

**Note:**

To set up a device without a display, please use the USB-büS interface, Type 8920 and for the FLOWave S with two outputs, the büS adaptor cable article no. 773286 is required too.

See **Software manual Type 8920** ▶ for more information.

| Accessories | No. | Description  |
|-------------|-----|--|
|             | 1   | Quick-Start  |
|             | 2   | Power supply:100...240 V AC/ 24 V DC 1 A and adaptors for power supply worldwide use                 |
|             | 3   | büS terminating resistor on büS Y-splitter   |
|             | 4   | 5 pin M12 male connector wired on free end cable   |
|             | 5   | büS connection cable with 5 pin M12 plug, micro USB B plug   |
|             | 6   | büS adapter with 5 pin M12 plug, A-coded to 5 pin M12 plug, A-coded                                  |
|             | 7   | büS stick (USB to büS/CANopen adaptor)   |
|             | 8   | büS service cable with 5 pin M12 plug, mini USB and circular plug-in connectors for power supply     |
|             | 9   | Magnetic key   |
|             | 10  | CD - Communicator (30-day license without registration, update and licensing over Bürkert home page) |

## 10. Ordering information

### 10.1. Bürkert eShop – Easy ordering and quick delivery



**Bürkert eShop – Easy ordering and fast delivery**

You want to find your desired Bürkert product or spare part quickly and order directly? Our online shop is available for you 24/7. Sign up and enjoy all the benefits.

Order online now

### 10.2. Recommendation regarding product selection

**Note:**

- The installation of the flowmeter in a pipe requires the use of counter-connection, seals, fixing elements, etc. depending on the used norm.
- The drawings show the installation with a standard version of the flow meter. The installation is also valid for the compact version.

For instance with middle-sized devices:

| Connection | Description  |
|------------|--|
|            | <p><b>With clamp according to DIN 32676 series A</b></p> <p>To insert a FLOWave DN 40 with clamps according to DIN 32676 series A (with Ra &lt;0.8 µm) to a pipe according to DIN 11866 series A (DIN 11850), the <b>correct adapters to be selected and separately ordered</b> are for instance</p> <ul style="list-style-type: none"> <li>• 2x <b>BBS-25</b> clamp ferrules, Article no. 747237, see <b>data sheet Type BBS-25</b> ▶ for more information</li> <li>• 2x the appropriate seals (not provided)</li> <li>• 2x the corresponding clamps, Article no. 731164</li> </ul> |

| Connection | Description  |
|------------|--|
|            | <p><b>With aseptic collar flange (BF) according to DIN 11864-2 form A</b><br/>To insert a FLOWave DN 40 with collar flanges according to DIN 11864-2 series B (with Ra &lt;math&gt;&lt;0.8 \mu\text{m}&lt;/math&gt;) to a pipe according to DIN 11866 series B (ISO 1127), the <b>correct adapters to be selected and separately ordered</b> are for instance</p> <ul style="list-style-type: none"> <li>• 2x <b>BBS-06</b> aseptic groove flange, Article no. 731860, see <b>data sheet Type BBS-06</b> ▶ for more information</li> <li>• 2x the appropriate seals (not provided)</li> <li>• 8x the corresponding screws, flat washers and nuts (please refer to the DIN 11864-2 standard)</li> </ul> |
|            | <p><b>With aseptic collar clamp (BKS) according to DIN 11864-3 form A</b><br/>To insert a FLOWave 1" with hygienic collar clamps according to DIN 11864-3 series C (with Ra &lt;math&gt;&lt;0.8 \mu\text{m}&lt;/math&gt;) to a pipe according to DIN 11866 series C (ASME BPE), the <b>correct adapters to be selected and separately ordered</b> are for instance</p> <ul style="list-style-type: none"> <li>• 2x <b>BBS-05</b> aseptic groove clamp, Article no. 730272, see <b>data sheet Type BBS-05</b> ▶ for more information</li> <li>• 2x the appropriate seals (not provided)</li> <li>• 2x the corresponding clamps, Article no. 731164</li> </ul>   |
|            | <p><b>With thread according to DIN 11851</b><br/>To insert a FLOWave with thread according to DIN 11851 series A to a pipe according to DIN 11850, the correct adapters to be procured locally on the market are for instance</p> <ul style="list-style-type: none"> <li>• 2x the conical ferrule</li> <li>• 2x the appropriate DIN 11851 seal</li> <li>• 2x the corresponding round slotted nut</li> </ul>  |

### 10.3. Bürkert product filter



#### Bürkert product filter – Get quickly to the right product

You want to select products comfortably based on your technical requirements? Use the Bürkert product filter and find suitable articles for your application quickly and easily.

[Try out our product filter](#)

### 10.4. Bürkert 3D Model - Interactive Animation

#### Applications & Tools



CAD Model



Interactive Animation

**Bürkert 3D Model - Interactive Animation**

3D Model and Interactive Animation are available on the website of the flowmeter Type 8098.





















See **website of the Type 8098** ▶ under “Applications and Tools”.

### 10.5. Ordering chart FLOWave L flowmeter with or without industrial communication

Clamp process connection acc. to DIN 32676 series A for pipe acc. to DIN 11866 series A (DIN 11850)

**Note:**

- To set up a device without a display, please use the USB-büS interface, Type 8920 (has to be ordered separately - see chapter "9. Product accessories" on page 29 and "10.7. Ordering chart accessories" on page 39).
- Device with Wi-Fi interface available on request.
- All these versions are equipped with the special functions ATF (acoustic transmission factor) and DF (density factor).

| Clamp and pipe size  | Surface quality                               |                                   | Clamp dimensions D2 x s; D3 (s = wall thickness) | Maximal flow rate   | Display | Certifications |                      | Article no.  |
|--|---|-----------------------------------|--|---------------------|---------|----------------|----------------------|--|
|  | Housing and outer surface of measurement tube | Inner surface of measurement tube |  |                     |         | 3A (28-06)     | EHEDG <sup>1.)</sup> |  |
| [mm]   | [µm]  | [µm]                              | [mm]   | [m <sup>3</sup> /h] |         |                |                      |  |
| <b>Version without industrial communication (2 cable glands<sup>2.)</sup> M20x1.5 + 1 x 5 pin M12 male connector), operating voltage of 12...35 V DC</b> |   |                                   |  |                     |         |                |                      |  |
| 08   | Ra<1.6  | Ra<0.8                            | 14.0x2.0; 34.0                                   | 3                   | Yes     | Yes            | Yes                  | On request   |
|  |   |                                   |  |                     | No      |                |                      | On request   |
|  |   | Ra<0.4                            |  |                     | Yes     |                |                      | On request   |
|  |   |                                   |  |                     | No      |                |                      | On request   |
| 15   | Ra<1.6  | Ra<0.8                            | 19.05 x 1.65; 34.0                               | 7                   | Yes     | Yes            | Yes                  | 569159    |
|  |   |                                   |  |                     | No      |                |                      | 569158    |
|  |   | Ra<0.4                            |  |                     | Yes     |                |                      | 569161    |
|  |   |                                   |  |                     | No      |                |                      | 569160    |
| 25   | Ra<1.6  | Ra<0.8                            | 25.4 x 1.65; 50.5                                | 14                  | Yes     | Yes            | Yes                  | 569163    |
|  |   |                                   |  |                     | No      |                |                      | 569162   |
|  |   | Ra<0.4                            |  |                     | Yes     |                |                      | 569165  |
|  |   |                                   |  |                     | No      |                |                      | 569164  |
| 40   | Ra<1.6  | Ra<0.8                            | 38.1 x 1.65; 50.5                                | 35                  | Yes     | Yes            | Yes                  | 569167  |
|  |   |                                   |  |                     | No      |                |                      | 569166  |
|  |   | Ra<0.4                            |  |                     | Yes     |                |                      | 569169  |
|  |   |                                   |  |                     | No      |                |                      | 569168  |
| 50   | Ra<1.6  | Ra<0.8                            | 50.8 x 1.65; 64.0                                | 64                  | Yes     | Yes            | Yes                  | 569171  |
|  |   |                                   |  |                     | No      |                |                      | 569170  |
|  |   | Ra<0.4                            |  |                     | Yes     |                |                      | 569173  |
|  |   |                                   |  |                     | No      |                |                      | 569172  |
| 65   | Ra<1.6  | Ra<0.8                            | 70.0x2.0; 91.0                                   | 123                 | Yes     | Yes            | Yes                  | 573445  |
|  |   | Ra<0.4                            |  |                     |         |                |                      | 573373  |
| 80   | Ra<1.6  | Ra<0.8                            | 85.0x2.0; 106.0                                  | 185                 |         | Yes            | Yes                  | 573446  |
|  |   | Ra<0.4                            |  |                     |         |                |                      | 573374  |

1.) The EHEDG compliance is only if used in combination with gaskets from Combifit International B.V.

2.) Cable gland in nickel plated brass valid

**Clamp process connection acc. to DIN 32676 series B for pipe acc. to DIN 11866 series B (ISO 1127)**

**Note:**

- To set up a device without a display, please use the USB-büS interface, Type 8920 (has to be ordered separately - see chapter “9. Product accessories” on page 29 and “10.7. Ordering chart accessories” on page 39).
- Device with Wi-Fi interface available on request.
- All these versions are equipped with the special functions ATF (acoustic transmission factor) and DF (density factor).

| Clamp and pipe size   | Surface quality                               |                                   | Clamp dimensions D2 x s; D3 (s = wall thickness) | Maximal flow rate | Display | Certifications |                      | Article no. |
|---|---|-----------------------------------|--|-------------------|---------|----------------|----------------------|-------------|
|   | Housing and outer surface of measurement tube | Inner surface of measurement tube |  |                   |         | 3A (28-06)     | EHEDG <sup>1.)</sup> |             |
| [mm]  | [µm]  | [µm]                              | [mm]   | [m³/h]            |         |                |                      |             |
| <b>Version without industrial communication (2 cable glands<sup>2.)</sup> M20x1.5+1 x5 pin M12 male connector), operating voltage of 12...35 V DC</b> |   |                                   |  |                   |         |                |                      |             |
| 08  | Ra<1.6  | Ra<0.8                            | 14 x 1.85; 25.0                                  | 3                 | Yes     | Yes            | Yes                  | 573126      |
|   |   | Ra<0.4                            |  |                   | No      |                |                      | 573127      |
|   |   |                                   |  |                   | Yes     |                |                      | 573128      |
|   |   | No                                |  |                   | 573129  |                |                      |             |
| 15  | Ra<1.6  | Ra<0.8                            | 21.3 x 1.6; 50.5                                 | 10                | Yes     | Yes            | Yes                  | 566187      |
|   |   |                                   |  |                   | No      |                |                      | 566235      |
|   |   |                                   |  |                   |         |                |                      | Yes         |
|   |   |                                   |  |                   | No      |                |                      | 566236      |
|   |   | Ra<0.4                            |  |                   | Yes     |                |                      | 566195      |
|   |   |                                   |  |                   | No      |                |                      | 566237      |
|   |   |                                   |  |                   |         |                |                      | Yes         |
|   |   |                                   |  |                   | No      |                |                      | 566238      |
| 25  | Ra<1.6  | Ra<0.8                            | 33.7 x 2.0; 50.5                                 | 25                | Yes     | Yes            | Yes                  | 566188      |
|   |   |                                   |  |                   | No      |                |                      | 566192      |
|   |   | Ra<0.4                            |  |                   | Yes     |                |                      | 566196      |
|   |   |                                   |  |                   | No      |                |                      | 566200      |
| 40  | Ra<1.6  | Ra<0.8                            | 48.3 x 2.0; 64.0                                 | 56                | Yes     | Yes            | Yes                  | 566189      |
|   |   |                                   |  |                   | No      |                |                      | 566193      |
|   |   |                                   |  |                   | Yes     |                |                      | 566197      |
|   |   | Ra<0.4                            |  |                   | No      |                |                      | 566201      |
|   |   |                                   |  |                   | Yes     |                |                      | 566190      |
|   |   |                                   |  |                   | No      |                |                      | 566194      |
| 50  | Ra<1.6  | Ra<0.8                            | 60.3 x 2.0; 77.5                                 | 90                | Yes     | Yes            | Yes                  | 566198      |
|   |   |                                   |  |                   | No      |                |                      | 566202      |
|   |   |                                   |  |                   | Yes     |                |                      | 566198      |
|   |   | Ra<0.4                            |  |                   | No      |                |                      | 566202      |
|   |   |                                   |  |                   | Yes     |                |                      | 566198      |
|   |   |                                   |  |                   | No      |                |                      | 566202      |
| 65  | Ra<1.6  | Ra<0.8                            | 76.1 x 2.0; 91.0                                 | 147               | Yes     | Yes            | Yes                  | 573442      |
|   |   | Ra<0.4                            |  |                   | 573370  |                |                      |             |
|   |   | Ra<0.8                            |  |                   | 573443  |                |                      |             |
| 80  | Ra<1.6  | Ra<0.8                            | 88.9 x 2.3; 106.0                                | 200               | Yes     | Yes            | Yes                  | 573371      |
|   |   | Ra<0.4                            |  |                   | 573371  |                |                      |             |



























1.) The EHEDG compliance is only valid if used in combination with gaskets from Combifit International B.V.  
 2.) Cable gland in nickel plated brass

DTS 1000270652 EN Version: P Status: RL (released | freigegeben | valide) printed: 30.04.2021



**Clamp process connection acc. to DIN 32676 series C for pipe acc. to DIN 11866 series C (ASME BPE)**
**Note:**

- To set up a device without a display, please use the USB-büS interface, Type 8920 (has to be ordered separately - see chapter "9. Product accessories" on page 29 and "10.7. Ordering chart accessories" on page 39).
- Device with Wi-Fi interface available on request.
- All these versions are equipped with the special functions ATF (acoustic transmission factor) and DF (density factor).

| Clamp and pipe size   | Surface quality                               |                                   | Clamp dimensions D2 x s; D3 (s = wall thickness) | Maximal flow rate   | Display  | Certifications |                     |     | Article no.  |
|---|---|-----------------------------------|--|---------------------|--|----------------|---------------------|-----|--|
|   | Housing and outer surface of measurement tube | Inner surface of measurement tube |  |                     |  | 3A (28-06)     | EHEDG <sup>1)</sup> | UL  |  |
| [inch]  | [µm]  | [µm]                              | [mm]   | [m <sup>3</sup> /h] |  |                |                     |     |  |
| <b>Version without industrial communication (2 cable glands<sup>2)</sup> M20x1.5 + 1 x 5 pin M12 male connector), operating voltage of 12...35 V DC</b> |   |                                   |  |                     |  |                |                     |     |  |
| 3/8   | Ra < 1.6                                      | Ra < 0.8                          | 14.00 x 3.125; 25.0                              | 1.7                 | Yes  | Yes            | Yes                 | No  | 573112    |
|   |   | Ra < 0.4                          |  |                     | No   |                |                     |     | 573113    |
|   |   |                                   |  |                     | Yes  |                |                     |     | 573114    |
|   |   | No                                |  |                     | 573115    |                |                     |     |  |
| 1/2   | Ra < 0.8                                      | Ra < 0.4                          | 14.00 x 2.3; 25.0                                | 2.5                 | Yes  | Yes            | Yes                 | No  | 573116    |
|   |   |                                   |  |                     | No   |                |                     |     | 573119    |
|   |   | Yes                               |  |                     | 573120    |                |                     |     |  |
|   |   | No                                |  |                     | 573121    |                |                     |     |  |
| 3/4   | Ra < 0.8                                      | Ra < 0.4                          | 19.05 x 1.65; 25.0                               | 7                   | Yes  | Yes            | Yes                 | No  | 573122    |
|   |   |                                   |  |                     | No   |                |                     |     | 573123   |
|   |   | Yes                               |  |                     | 566203  |                |                     |     |  |
|   |   | No                                |  |                     | 566207  |                |                     |     |  |
| 1   | Ra < 0.8                                      | Ra < 0.4                          | 25.4 x 1.65; 50.5                                | 14                  | Yes  | Yes            | Yes                 | No  | 566211  |
|   |   |                                   |  |                     | No   |                |                     |     | 566215  |
|   |   | Yes                               |  |                     | 569675  |                |                     |     |  |
|   |   | No                                |  |                     | 566204  |                |                     |     |  |
| 1 1/2   | Ra < 0.8                                      | Ra < 0.4                          | 38.1 x 1.65; 50.5                                | 35                  | Yes  | Yes            | Yes                 | No  | 566212  |
|   |   |                                   |  |                     | No   |                |                     |     | 566216  |
|   |   | Yes                               |  |                     | 569676  |                |                     |     |  |
|   |   | No                                |  |                     | 566205  |                |                     |     |  |
| 2   | Ra < 0.8                                      | Ra < 0.4                          | 50.8 x 1.65; 64.0                                | 64                  | Yes  | Yes            | Yes                 | No  | 566213  |
|   |   |                                   |  |                     | No   |                |                     |     | 566217  |
|   |   | Yes                               |  |                     | 569677  |                |                     |     |  |
|   |   | No                                |  |                     | 566206  |                |                     |     |  |
| 2 1/2   | Ra < 0.8                                      | Ra < 0.4                          | 63.5 x 1.65; 77.5                                | 100                 | Yes  | Yes            | Yes                 | No  | 566214  |
|   |   |                                   |  |                     | No   |                |                     |     | 566218  |
|   |   | Yes                               |  |                     | 569678  |                |                     |     |  |
|   |   | No                                |  |                     | 573448  |                |                     |     |  |
| 3   | Ra < 0.8                                      | Ra < 0.4                          | 76.2 x 1.65; 91.0                                | 150                 | Yes  | Yes            | Yes                 | No  | 573376  |
|   |   |                                   |  |                     | No   |                |                     |     | 574710  |
|   |   | Yes                               |  |                     | 573449  |                |                     |     |  |
|   |   | No                                |  |                     | 573377  |                |                     |     |  |
|   |   |                                   |  |                     |  |                |                     | Yes | 574711  |

| Clamp and pipe size  | Surface quality                               |                                   | Clamp dimensions D2 x s; D3 (s = wall thickness) | Maximal flow rate   | Display | Certifications |                      |    | Article no. |
|--|---|-----------------------------------|--|---------------------|---------|----------------|----------------------|----|-------------|
|  | Housing and outer surface of measurement tube | Inner surface of measurement tube |  |                     |         | 3A (28-06)     | EHEDG <sup>1.)</sup> | UL |             |
| [inch]   | [µm]  | [µm]                              | [mm]   | [m <sup>3</sup> /h] |         |                |                      |    |             |
| <b>Version with industrial communication (Ethernet version, 2 x 4 pin M12 female connectors + 1 x 5 pin M12 male connector), operating voltage of 12...35 V DC</b> |   |                                   |  |                     |         |                |                      |    |             |
| 3/8  | Ra < 1.6                                      | Ra < 0.4                          | 14.00 x 3.125; 25.0                              | 1.7                 | Yes     | Yes            | Yes                  | No | 573117      |
|  |   |                                   | Yes  | 573118              |         |                |                      |    |             |
| 1/2  |   |                                   | 14.00 x 2.3; 25.0                                | 2.5                 |         |                |                      | No | 573124      |
|  |   |                                   | Yes  | 573125              |         |                |                      |    |             |
| 3/4  |   |                                   | 19.05 x 1.65; 25.0                               | 7                   |         |                |                      | No | 570444      |
|  |   |                                   | Yes  | 569679              |         |                |                      |    |             |
| 1  |   |                                   | 25.4 x 1.65; 50.5                                | 14                  |         |                |                      | No | 570445      |
|  |   |                                   | Yes  | 569680              |         |                |                      |    |             |
| 1 1/2  |   |                                   | 38.1 x 1.65; 50.5                                | 35                  |         |                |                      | No | 570446      |
|  |   |                                   | Yes  | 569681              |         |                |                      |    |             |
| 2  | 50.8 x 1.65; 64.0                             | 64                                | No   | 570447              |         |                |                      |    |             |
|  | Yes   | 569682                            |  |                     |         |                |                      |    |             |
| 2 1/2  | 63.5 x 1.65; 77.5                             | 100                               | No   | 574716              |         |                |                      |    |             |
|  | Yes   | 574720                            |  |                     |         |                |                      |    |             |
| 3  | 76.2 x 1.65; 91.0                             | 150                               | No   | 574717              |         |                |                      |    |             |
|  | Yes   | 574721                            |  |                     |         |                |                      |    |             |

1.) The EHEDG compliance is only valid if used in combination with gaskets from Combifit International B.V.

2.) Cable gland in nickel plated brass

#### Thread process connection acc. to DIN 11851 series A for pipe acc. to DIN 11866 series A (DIN 11850)

##### Note:

- To set up a device without a display, please use the USB-büS interface, Type 8920 (has to be ordered separately - see chapter "9. Product accessories" on page 29 and "10.7. Ordering chart accessories" on page 39).
- Device with Wi-Fi interface available on request.
- All these versions are equipped with the special functions ATF (acoustic transmission factor) and DF (density factor).

| Thread and pipe size   | Surface quality                               |                                   | Thread connection dimensions D2 x s; D3 (s = wall thickness) | Maximal flow rate   | Display | Certifications |                      |        | Article no. |
|--|---|-----------------------------------|--|---------------------|---------|----------------|----------------------|--------|-------------|
|  | Housing and outer surface of measurement tube | Inner surface of measurement tube |  |                     |         | 3A (28-06)     | EHEDG <sup>1.)</sup> |        |             |
| [mm]   | [µm]  | [µm]                              | [mm]   | [m <sup>3</sup> /h] |         |                |                      |        |             |
| <b>Version without industrial communication (2 cable glands<sup>2.)</sup> M20x1.5 + 1 x 5 pin M12 male connector), operating voltage of 12...35 V DC</b> |   |                                   |  |                     |         |                |                      |        |             |
| 65   | Ra < 1.6                                      | Ra < 0.8                          | 70.0 x 2.0; Rd 95 x 1/6                                      | 123                 | Yes     | Yes            | Yes                  | 573463 |             |
| 80   |   | Ra < 0.8                          | 85.0 x 2.0; Rd 110 x 1/4                                     | 185                 |         |                |                      | 573464 |             |

1.) The EHEDG compliance is only valid if used in combination with EHEDG-compliant gaskets from

1. Kieselmann GmbH, Germany (ASEPTO-STAR k-flex upgrade gaskets) or

2. Siersema Componenten Service (S.K.S.) B.V. (Netherlands SKS gasket set DIN 11851 EHEDG with EPDM or FKM inner gasket)

| Further versions on request   |   |
|---|---|
| <b>Process connection</b> <ul style="list-style-type: none"> <li>For pipe DIN 11850:               <ul style="list-style-type: none"> <li>Clamp DIN 11864-3</li> <li>Flange DIN 11864-2</li> </ul> </li> <li>For pipe ISO 1127:               <ul style="list-style-type: none"> <li>Clamp DIN 11864-3</li> <li>Flange DIN 11864-2</li> </ul> </li> <li>For pipe ASME BPE:               <ul style="list-style-type: none"> <li>Clamp DIN 11864-3</li> <li>Flange DIN 11864-2</li> </ul> </li> <li>For pipe SMS 3008: SMS 3017</li> </ul> | <b>Additional</b> <ul style="list-style-type: none"> <li>With/without display</li> <li>Wi-Fi module (only for EU and north America)</li> <li>Without density factor (DF)</li> <li>Without acoustic transmission factor (ATF)</li> <li>Ethernet module (EtherNet/IP, PROFINET, Modbus TCP/IP, ETHERCAT)</li> <li>ATEX</li> </ul> |
| <b>Orifice</b> <ul style="list-style-type: none"> <li>08...80 mm</li> <li>¾...3 inch</li> </ul>   | <b>Electrical connection</b><br>Cable gland in stainless steel  |

For any other versions, please use the product enquiry form at the end of this data sheet.

## 10.6. Ordering chart FLOWave S flowmeter

Clamp process connection acc. to DIN 32676 series A for pipe acc. to DIN 11866 series A (DIN 11850)

### Note:

All these versions are equipped with the special functions ATF (acoustic transmission factor) and DF (density factor).





























| Clamp and pipe size   | Surface quality                               |                                   | Clamp dimensions<br>D2 x s; D3<br>(s = wall thickness) | Maximal flow rate   | Certifications |                      | Article no. |
|---|---|-----------------------------------|--|---------------------|----------------|----------------------|-------------|
|   | Housing and outer surface of measurement tube | Inner surface of measurement tube |  |                     | 3A (28-06)     | EHEDG <sup>1.)</sup> |             |
| [mm]  | [µm]  | [µm]                              | [mm]   | [m <sup>3</sup> /h] |                |                      |             |
| <b>Electrical connection: 1 x 8 pin M12 male connector, operating voltage of 12...35 V DC</b> |   |                                   |  |                     |                |                      |             |
| 65  | Ra < 1.6                                      | Ra < 0.8                          | 70.0 x 2.0; 91.0                                       | 123                 | Yes            | Yes                  | 574689      |
|   |   | Ra < 0.4                          |  |                     |                |                      | 573421      |
| 80  |   | Ra < 0.8                          | 85.0 x 2.0; 106.0                                      | 185                 |                |                      | 574690      |
|   |   | Ra < 0.4                          |  |                     |                |                      | 573422      |

1.) The EHEDG compliance is only valid if used in combination with gaskets from Combifit International B.V.

Clamp process connection acc. to DIN 32676 series B for pipe acc. to DIN 11866 series B (ISO 1127)

**Note:**

All these versions are equipped with the special functions ATF (acoustic transmission factor) and DF (density factor).

| Clamp and pipe size   | Surface quality                               |                                   | Clamp dimensions<br>D2 x s; D3<br>(s = wall thickness) | Maximal flow rate   | Certifications   |                      | Article no.  |
|---|---|-----------------------------------|--|---------------------|--|----------------------|--|
|   | Housing and outer surface of measurement tube | Inner surface of measurement tube |  |                     | 3A (28-06)   | EHEDG <sup>1.)</sup> |  |
| [mm]  | [µm]  | [µm]                              | [mm]   | [m <sup>3</sup> /h] |  |                      |  |
| <b>Electrical connection: 1 x 5 pin M12 male connector, operating voltage of 12...35 V DC</b> |   |                                   |  |                     |  |                      |  |
| 08  | Ra<1.6  | Ra<0.8                            | 14 x 1.85; 25.0  | 3                   | Yes  | Yes                  | 573716    |
|   |   | Ra<0.4                            |  |                     |  |                      | 573717    |
| 15  |   | Ra<0.8                            | 21.3 x 1.6; 50.5                                       | 10                  |  | Yes                  | 573093    |
|   |   |                                   | 21.3 x 1.6; 34.0                                       |                     |  | No                   | 573094    |
|   |   | Ra<0.4                            | 21.3 x 1.6; 50.5                                       |                     |  | Yes                  | 573098    |
|   |   |                                   | 21.3 x 1.6; 34.0                                       |                     |  | No                   | 573099    |
| 25  |   | Ra<0.8                            | 33.7 x 2.0; 50.5                                       | 25                  |  | Yes                  | 573095    |
|   |   | Ra<0.4                            |  |                     |  |                      | 573100    |
| 40  | Ra<0.8  | 48.3 x 2.0; 64.0                  | 56   |                     | 573096    |                      |  |
|   | Ra<0.4  |                                   |  |                     | 573101    |                      |  |
| 50  | Ra<0.8  | 60.3 x 2.0; 77.5                  | 90   |                     | 573097    |                      |  |
|   | Ra<0.4  |                                   |  |                     | 573102    |                      |  |
| <b>Electrical connection: 1 x 8 pin M12 male connector, operating voltage of 12...35 V DC</b> |   |                                   |  |                     |  |                      |  |
| 08  | Ra<1.6  | Ra<0.8                            | 14 x 1.85; 25.0  | 3                   | Yes  | Yes                  | 571780    |
|   |   | Ra<0.4                            |  |                     |  |                      | 571781  |
| 15  |   | Ra<0.8                            | 21.3 x 1.6; 50.5                                       | 10                  |  | Yes                  | 571782  |
|   |   |                                   | 21.3 x 1.6; 34.0                                       |                     |  | No                   | 571783  |
|   |   | Ra<0.4                            | 21.3 x 1.6; 50.5                                       |                     |  | Yes                  | 571784  |
|   |   |                                   | 21.3 x 1.6; 34.0                                       |                     |  | No                   | 571785  |
| 25  |   | Ra<0.8                            | 33.7 x 2.0; 50.5                                       | 25                  |  | Yes                  | 571786  |
|   |   | Ra<0.4                            |  |                     |  |                      | 571787  |
| 40  | Ra<0.8  | 48.3 x 2.0; 64.0                  | 56   |                     | 571788  |                      |  |
|   | Ra<0.4  |                                   |  |                     | 571789  |                      |  |
| 50  | Ra<0.8  | 60.3 x 2.0; 77.5                  | 90   |                     | 571790  |                      |  |
|   | Ra<0.4  |                                   |  |                     | 571791  |                      |  |
| 65  | Ra<0.8  | 76.1 x 2.0; 91.0                  | 147  |                     | 574686  |                      |  |
|   | Ra<0.4  |                                   |  |                     | 573418  |                      |  |
| 80  | Ra<0.8  | 88.9 x 2.3; 106.0                 | 200  |                     | 574687  |                      |  |
|   | Ra<0.4  |                                   |  |                     | 573419  |                      |  |

1.) The EHEDG compliance is only valid if used in combination with gaskets from Combifit International B.V.

Clamp process connection acc. to DIN 32676 series C for pipe acc. to DIN 11866 series C (ASME BPE)

**Note:**

All these versions are equipped with the special functions ATF (acoustic transmission factor) and DF (density factor).

| Clamp and pipe size   | Surface quality                               |                                   | Clamp dimensions D2 x s; D3 (s = wall thickness) | Maximal flow rate   | Certifications |                      |     | Article no. |
|---|---|-----------------------------------|--|---------------------|----------------|----------------------|-----|-------------|
|   | Housing and outer surface of measurement tube | Inner surface of measurement tube |  |                     | 3A (28-06)     | EHEDG <sup>1.)</sup> | UL  |             |
| [inch]  | [µm]  | [µm]                              | [mm]   | [m <sup>3</sup> /h] |                |                      |     |             |
| <b>Electrical connection: 1 x 5 pin M12 male connector, operating voltage of 12...35 V DC</b> |   |                                   |  |                     |                |                      |     |             |
| 3/8   | Ra<1.6  | Ra<0.8                            | 14.00x3.125; 25.0                                | 1.7                 | Yes            | Yes                  | No  | 573710      |
|   |   | Ra<0.4                            |  |                     |                |                      | Yes | 573711      |
| 1/2   | Ra<1.6  | Ra<0.8                            | 14.00x2.3; 25.0                                  | 2.5                 | Yes            | Yes                  | No  | 573712      |
|   |   | Ra<0.4                            |  |                     |                |                      | Yes | 573713      |
| 3/4   | Ra<1.6  | Ra<0.8                            | 19.05x1.65; 25.0                                 | 7                   | Yes            | Yes                  | No  | 573714      |
|   |   | Ra<0.4                            |  |                     |                |                      | Yes | 573715      |
| 1   | Ra<1.6  | Ra<0.8                            | 25.4x1.65; 50.5                                  | 14                  | Yes            | Yes                  | No  | 573085      |
|   |   | Ra<0.4                            |  |                     |                |                      | Yes | 573086      |
| 1 1/2   | Ra<1.6  | Ra<0.8                            | 19.05x1.65; 25.0                                 | 7                   | Yes            | Yes                  | No  | 573087      |
|   |   | Ra<0.4                            |  |                     |                |                      | Yes | 573088      |
| 2   | Ra<1.6  | Ra<0.8                            | 25.4x1.65; 50.5                                  | 14                  | Yes            | Yes                  | No  | 573089      |
|   |   | Ra<0.4                            |  |                     |                |                      | Yes | 573090      |
| 2 1/2   | Ra<1.6  | Ra<0.8                            | 38.1x1.65; 50.5                                  | 35                  | Yes            | Yes                  | No  | 573091      |
|   |   | Ra<0.4                            |  |                     |                |                      | Yes | 573092      |
| 3   | Ra<1.6  | Ra<0.8                            | 50.8x1.65; 64.0                                  | 64                  | Yes            | Yes                  | No  | 573093      |
|   |   | Ra<0.4                            |  |                     |                |                      | Yes | 573094      |
| <b>Electrical connection: 1 x 8 pin M12 male connector, operating voltage of 12...35 V DC</b> |   |                                   |  |                     |                |                      |     |             |
| 3/8   | Ra<1.6  | Ra<0.8                            | 14.00x3.125; 25.0                                | 1.7                 | Yes            | Yes                  | No  | 571792      |
|   |   | Ra<0.4                            |  |                     |                |                      | Yes | 571793      |
| 1/2   | Ra<1.6  | Ra<0.8                            | 14.00x2.3; 25.0                                  | 2.5                 | Yes            | Yes                  | No  | 571794      |
|   |   | Ra<0.4                            |  |                     |                |                      | Yes | 571795      |
| 3/4   | Ra<1.6  | Ra<0.8                            | 19.05x1.65; 25.0                                 | 7                   | Yes            | Yes                  | No  | 571796      |
|   |   | Ra<0.4                            |  |                     |                |                      | Yes | 571797      |
| 1   | Ra<1.6  | Ra<0.8                            | 25.4x1.65; 50.5                                  | 14                  | Yes            | Yes                  | No  | 571798      |
|   |   | Ra<0.4                            |  |                     |                |                      | Yes | 571799      |
| 1 1/2   | Ra<1.6  | Ra<0.8                            | 19.05x1.65; 25.0                                 | 7                   | Yes            | Yes                  | No  | 571800      |
|   |   | Ra<0.4                            |  |                     |                |                      | Yes | 571801      |
| 2   | Ra<1.6  | Ra<0.8                            | 25.4x1.65; 50.5                                  | 14                  | Yes            | Yes                  | No  | 571802      |
|   |   | Ra<0.4                            |  |                     |                |                      | Yes | 571803      |
| 2 1/2   | Ra<1.6  | Ra<0.8                            | 38.1x1.65; 50.5                                  | 35                  | Yes            | Yes                  | No  | 571804      |
|   |   | Ra<0.4                            |  |                     |                |                      | Yes | 571805      |
| 3   | Ra<1.6  | Ra<0.8                            | 50.8x1.65; 64.0                                  | 64                  | Yes            | Yes                  | No  | 571806      |
|   |   | Ra<0.4                            |  |                     |                |                      | Yes | 571807      |
| 3 1/2   | Ra<1.6  | Ra<0.8                            | 63.5x1.65; 77.5                                  | 100                 | Yes            | Yes                  | No  | 571808      |
|   |   | Ra<0.4                            |  |                     |                |                      | Yes | 571809      |
| 4   | Ra<1.6  | Ra<0.8                            | 76.2x1.65; 91.0                                  | 150                 | Yes            | Yes                  | No  | 574692      |
|   |   | Ra<0.4                            |  |                     |                |                      | Yes | 574693      |
| 4 1/2   | Ra<1.6  | Ra<0.8                            | 76.2x1.65; 91.0                                  | 150                 | Yes            | Yes                  | No  | 573424      |
|   |   | Ra<0.4                            |  |                     |                |                      | Yes | 573425      |
| 5   | Ra<1.6  | Ra<0.8                            | 76.2x1.65; 91.0                                  | 150                 | Yes            | Yes                  | No  | 574718      |
|   |   | Ra<0.4                            |  |                     |                |                      | Yes | 574719      |

1.) The EHEDG compliance is only valid if used in combination with gaskets from Combifit International B.V.

DTS 1000270652 EN Version: P Status: RL (released | freigegeben | valide) printed: 30.04.2021

**Thread process connection acc. to DIN 11851 series A for pipe acc. to DIN 11866 series A (DIN 11850)**
**Note:**

All these versions are equipped with the special functions ATF (acoustic transmission factor) and DF (density factor).

| Thread and pipe size  | Surface quality                               |                                   | Thread connection dimensions<br>D2 x s; D3<br>(s = wall thickness) | Maximal flow rate   | Certifications |                      | Article no. |
|---|---|-----------------------------------|--|---------------------|----------------|----------------------|-------------|
|   | Housing and outer surface of measurement tube | Inner surface of measurement tube |  |                     | 3A (28-06)     | EHEDG <sup>1.)</sup> |             |
| [mm]  | [µm]  | [µm]                              | [mm]   | [m <sup>3</sup> /h] |                |                      |             |
| <b>Electrical connection: 1 x 8 pin M12 male connector, operating voltage of 12...35 V DC</b> |   |                                   |  |                     |                |                      |             |
| 65  | Ra < 1.6                                      | Ra < 0.8                          | 70.0 x 2.0; Rd 95 x 1/6  | 123                 | Yes            | Yes                  | 574707      |
| 80  |   | Ra < 0.8                          | 85.0 x 2.0; Rd 110 x 1/4   | 185                 |                |                      | 574708      |

1.) The EHEDG compliance is only valid if used in combination with EHEDG-compliant gaskets from

- Kieselmann GmbH, Germany (ASEPTO-STAR k-flex upgrade gaskets) or
- Siersema Componenten Service (S.K.S.) B.V. (Netherlands SKS gasket set DIN 11851 EHEDG with EPDM or FKM inner gasket)

**Further versions on request**

|  |  |  |   |
|--|--|--|---|
|  | <b>Process connection</b> <ul style="list-style-type: none"> <li>For pipe DIN 11850:           <ul style="list-style-type: none"> <li>Clamp DIN 32676</li> <li>Clamp DIN 11864-3</li> <li>Flange DIN 11864-2</li> </ul> </li> <li>For pipe ISO 1127:           <ul style="list-style-type: none"> <li>Clamp DIN 11864-3</li> <li>Flange DIN 11864-2</li> </ul> </li> <li>For pipe ASME BPE:           <ul style="list-style-type: none"> <li>Clamp DIN 11864-3</li> <li>Flange DIN 11864-2</li> </ul> </li> <li>For pipe SMS 3008: SMS 3017</li> </ul> |  | <b>Orifice</b> <ul style="list-style-type: none"> <li>08...80 mm</li> <li>3/8...3 inch</li> </ul>   |
|  |  |  | <b>Electrical connection</b> <ul style="list-style-type: none"> <li>1 x 5 pin M12 male connector</li> <li>1 x 8 pin M12 male connector</li> </ul>   |
|  |  |  | <b>Additional</b> <ul style="list-style-type: none"> <li>Without density factor (DF)</li> <li>Without acoustic transmission factor (ATF)</li> <li>With inner surface of measurement tube: Ra &lt; 0.8 µm</li> </ul> |

For any other versions, please use the product enquiry form at the end of this data sheet.

## 10.7. Ordering chart accessories

| Description  | Article no.  |
|--|--------------|
| Display module, Type ME31  | 265468       |
| Blind cover in stainless steel 304/1.4301  | 265467       |
| Unlocking magnetic key   | 690309       |
| <b>System Connect</b>  |              |
| <b>Type ME43 Gateway / Interface</b>   |              |
| büS/Ethernet (PROFINET, EtherNet/IP, Modbus TCP, EtherCAT)   | 307390       |
| büS/Profibus DP  | 307393       |
| <b>Type ME61 Display</b>   |              |
| Process View Display 3.5" (8.9 cm)   | 368544       |
| <b>EDIP Accessories</b>  |              |
| <b>büS Stick Set</b>   |              |
| USB-büS-Interface Set 1, Type 8920. Detailed information can be found in chapter <b>"9. Product accessories"</b> on page 29. | 772426       |
| USB-büS Interface Set 2, Type 8920 (only büS Stick, cable and büS service cable)   | 772551       |
| <b>Connectors</b>  |              |
| 5 pin M12 female straight büS cable plug   | 772416       |
| 5 pin M12 male straight büS cable plug   | 772417       |
| 5 pin M12 female angled büS cable plug   | 772418       |
| 5 pin M12 male angled büS cable plug   | 772419       |
| büS Y-connector, 5 pin M12 female to 5 pin M12 male and 5 pin M12 female   | 772420       |
| büS Y-connector, 5 pin M12 female to 5 pin M12 male and 5 pin M12 female (power interrupt)                                   | 772421       |
| büS adaptor M12 male A-coded - M12 male A-coded  | 772867       |
| büS termination, 5 pin M12 male cable plug   | 772424       |
| büS termination, 5 pin M12 female cable plug   | 772425       |
| Adaptor cable, 8 pin M12 female - 5 pin M12 male   | 773286       |
| <b>Connectors with cable</b>   |              |
| 5 pin M12 female angled cable plug moulded on büS cable, with open leads   | 0,7 m 772626 |
| 5 pin M12 female straight cable plug moulded on büS cable, with open leads   | 1 m 772409   |
|  | 3 m 772410   |
|  | 5 m 772411   |
|  | 10 m 772412  |
| Micro USB and 5 pin M12 male straight cable plug moulded on büS cable  | 0,3 m 773254 |
| 8 pin M12 female straight cable plug moulded on büS cable, with open leads   | 2 m 919061   |
| <b>Extensions</b>  |              |
| 5 pin M12 female and male straight cable plug moulded on büS cable, shielded   | 0,1 m 772492 |
|  | 0,2 m 772402 |
|  | 0,5 m 772403 |
|  | 1 m 772404   |
|  | 3 m 772405   |
|  | 5 m 772406   |
|  | 10 m 772407  |
| 20 m 772408  |              |
| <b>Type 1573 Power Supplies</b>  |              |
| 1 A (NEC Class 2 Power Units)  | 772361       |
| 2 A (NEC Class 2 Power Units)  | 772362       |
| 3.8 A (NEC Class 2 Power Units)  | 772898       |
| 10 A   | 772698       |



# Bürkert – Close to You

For up-to-date addresses  
please visit us at  
[www.burkert.com](http://www.burkert.com)

DTS 1000270652 EN Version: P Status: RL (released | freigegeben | validé) printed: 30.04.2021





## Product Enquiry Form - FLOWave SAW flowmeter

Thank you for your interest in our products! In order to provide you with optimum advice, please fill out the following form and send it to your **Bürkert representative** or e-mail address: [info@burkert.com](mailto:info@burkert.com). All information submitted will of course be kept strictly confidential.

**Note:** The interactive functions of this PDF may be restricted depending on the PDF reader used.

| Personal Information |  |                                  |  |
|----------------------|--|----------------------------------|--|
| <b>Company</b>       |  | <b>Contact person</b>            |  |
| <b>Customer no.</b>  |  | <b>Department</b>                |  |
| <b>Street</b>        |  | <b>Country / Postcode / Town</b> |  |
| <b>Telephone no.</b> |  | <b>Email</b>                     |  |

| Delivery |                        |
|----------|------------------------|
| Quantity | Required delivery date |

| Operating data  |       |      |      |
|---|-------|------|------|
| <b>Function</b><br>(Function of the flowmeter in the process / process description) |       |      |      |
| <b>Type of medium</b>   | Fluid |      |      |
| <b>Process fluid</b>  |       |      |      |
| <b>Flow rate (Q)<sup>1.)</sup></b>  | Min.  | Max. | Unit |
| <b>Temperature</b>  | Min.  | Max. | Unit |
| <b>Absolute pressure</b>  | Min.  | Max. | Unit |
| <b>Viscosity</b>  | Min.  | Max. | Unit |
| <b>Density</b>  | Min.  | Max. | Unit |

1.) Standard unit: Fluid Q = m<sup>3</sup>/h

| Process connection              |                       |                             |                       |                            |  |
|---------------------------------|-----------------------|-----------------------------|-----------------------|----------------------------|--|
| <b>Pipe diameter DN</b>         | 08<br>40<br>¾"<br>1½" | 15<br>50<br>½"<br>2"        | 25<br>65<br>¾"<br>2½" | 80<br>1"<br>3"             |  |
| <b>Connection<sup>1.)</sup></b> | <b>Pipe DIN 11850</b> | Clamp DIN 32676 series A    |                       | Clamp DIN 11864-3 series A |  |
|                                 |                       | Flange DIN 11864-2 series A |                       |                            |  |
|                                 |                       | Thread DIN 11851 series A   |                       |                            |  |
|                                 | <b>Pipe ISO 1127</b>  | Clamp DIN 32676 series B    |                       | Clamp DIN 11864-3 series B |  |
|                                 |                       | Flange DIN 11864-2 series B |                       |                            |  |
|                                 | <b>Pipe ASME BPE</b>  | Clamp DIN 32676 series C    |                       | Clamp DIN 11864-3 series C |  |
|                                 |                       | Flange DIN 11864-2 series C |                       |                            |  |
|                                 | <b>Pipe SMS 3008</b>  | SMS 3017                    |                       |                            |  |

1.) 3A & EHEDG certificate available (see restriction in certificate/certification specification in technical table)

DTS 1000270652 EN Version: P Status: RL (released | freigegeben | valide) printed: 30.04.2021

| Additional configuration                            |  |  |  |
|---|--|--|--|
| <b>Surface finish (inner surface)</b>               | Ra < 0.8 µm (30 µin.)  |  | Ra < 0.4 µm (15 µin.)  |
| <b>FLOWave L<br/>Electrical connection</b>          | Cable glands and M12 male connector (A-coded), in nickel plated brass (standard version) | Cable glands and M12 male connector (A-coded), in stainless steel (Full stainless steel or ATEX version) | M12 female connectors (D-coded) and M12 male connector (A-coded) in stainless steel (Ethernet version) |
| <b>FLOWave S<br/>Electrical connection</b>          | 5 pin M12 male connector (A-coded) in stainless steel (bÜS version)                      |  | 8 pin M12 male connector (A-coded) in stainless steel (version with 2 configurable outputs (DO/AO))    |
| <b>Display module</b>                               | With   |  | Without  |
| <b>Wi-Fi module (only for EU and north America)</b> | With   |  | Without  |
| <b>Ethernet protocols</b>                           | Modbus TCP<br>EtherNet/IP  | PROFINET<br>EtherCAT®  | Without  |
| <b>Special functions</b>                            | With density factor (DF)<br>With acoustic transmission factor (ATF)                      |  | Without density factor (DF)<br>Without acoustic transmission factor (ATF)                              |
| <b>Certification</b>                                | UL listed 1 + CULus  | ATEX   | Without  |

| Certification   |
|---|
| FDA certificate (included in delivery)  |
| Inspection certificate 3.1 acc. to EN 10204 (included in delivery)  |
| Certification of compliance ASME BPE (included in delivery)   |
| Calibration certificate (included in delivery)  |
| EHEDG - TYPE EL-CLASS I <sup>1)</sup> (included in delivery)  |
| 3A -28-06 (included in delivery)  |
| USP class VI declaration  |
| ECR1935/2004 declaration  |
| CRN 0C21751 declaration   |
| Test report 2.2 acc. to EN 10204 (article no. 803722)   |
| Certification of conformity for the surface quality DIN 4762; EN ISO 4287; EN ISO 4288 (article no. 804175) |
| Certification of conformity for passivation and electropolishing processes (article no. 444900)             |
| MTBF (Mean Time Between Failures) manufacturer declaration  |

1.) The EHEDG compliance is only valid if used in combination with gaskets from Combifit International B.V, Kieselmann GmbH, Germany or Siersema Komponenten Service (S.K.S.) B.V. according to the device version.

**Note:** If a certification which is not included in delivery with the FLOWave is requested, please order it separately. If you want to order one or more later, please contact your Bürkert office.

| Additional Requirements / Comment |
|-----------------------------------|
|                                   |

DTS 1000270652 EN Version: P Status: RL (released | freigegeben | valide) printed: 30.04.2021