



Temperature Controller

$1/16$ DIN - 48 x 48



ISO 9001
Certified

M1 line

User manual • M.I.U.M1-5/09.05 • Cod. J30-478-1AM1 IE



Ascon Tecnologica srl
via Indipendenza 56,
27029 Vigevano (PV)
Tel.: +39-0381 69 871
Fax: +39-0381 69 8730

Internet site:

www.ascontecnologic.com

E-Mail address:

sales@ascontecnologic.com



Temperature Controller

$\frac{1}{16}$ DIN - 48 x 48

M1 line

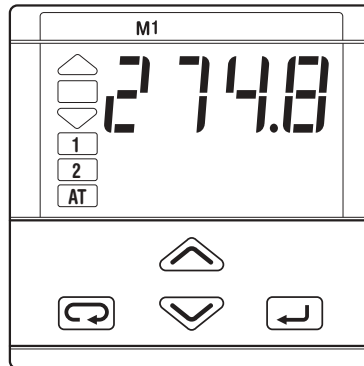



NOTES

ON ELECTRIC SAFETY AND ELECTROMAGNETIC COMPATIBILITY

Please, read carefully these instructions before proceeding with the installation of the controller.

Class II instrument, rear panel mounting.

This controller has been designed with compliance to:

Regulations on electrical apparatus (appliance, systems and installations) according to the European Community directive 73/23/EEC amended by the European Community directive 93/68/EEC and the Regulations on the essential protection requirements in electrical apparatus EN61010-1 : 93 + A2:95.

Regulations on Electromagnetic Compatibility according to the European Community directive n089/336/EEC, amended by the European Community directive no. 92/31/EEC, 93/68/EEC, 98/13/EEC and the following regulations:

Regulations on RF emissions

EN61000-6-3 : 2001 residential environments

EN61000-6-4 : 2001 industrial environments

Regulation on RF immunity

EN61000-6-2 : 2001 industrial equipment and system

It is important to understand that it's responsibility of the installer to ensure the compliance of the regulations on safety requirements and EMC.

The device has no user serviceable parts and requires special equipment and specialised engineers. Therefore, a repair can be hardly carried on directly by the user. For this purpose, the manufacturer provides technical assistance and the repair service for its Customers.

Please, contact your nearest Agent for further information.

All the information and warnings about safety and electromagnetic compatibility are marked with the  sign, at the side of the note.

TABLE OF CONTENTS

1	INSTALLATION	Page	4
2	ELECTRICAL CONNECTIONS	Page	8
3	PRODUCT CODING	Page	14
4	OPERATIONS	Page	18
5	AUTOMATIC TUNE	Page	28
6	TECHNICAL SPECIFICATIONS	Page	29

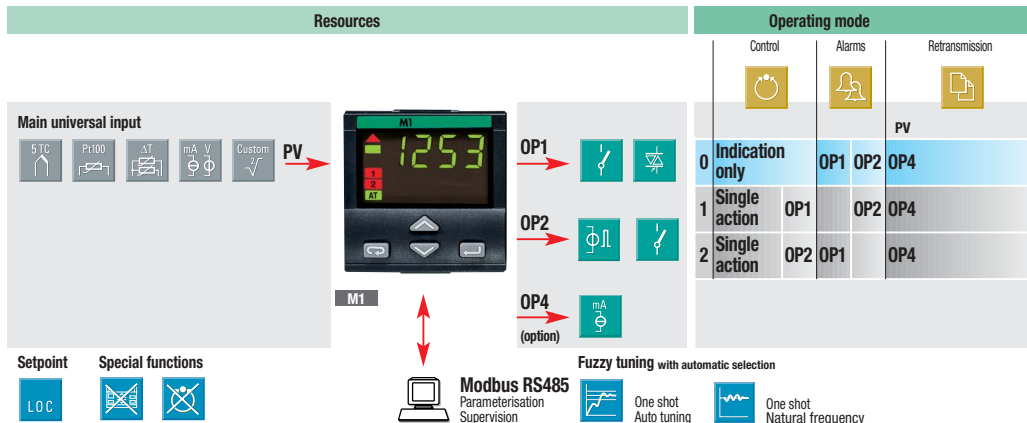

INSTALLATION

Installation must only be carried out by qualified personnel.

Before proceeding with the installation of this controller, follow the instructions illustrated in this manual and, particularly the installation precautions marked with the  symbol, related to the European Community directive on electrical protection and electromagnetic compatibility.



To prevent hands or metal touching parts that may be electrically live, the controllers must be installed in an enclosure and/or in a cubicle.

1.1 GENERAL DESCRIPTION

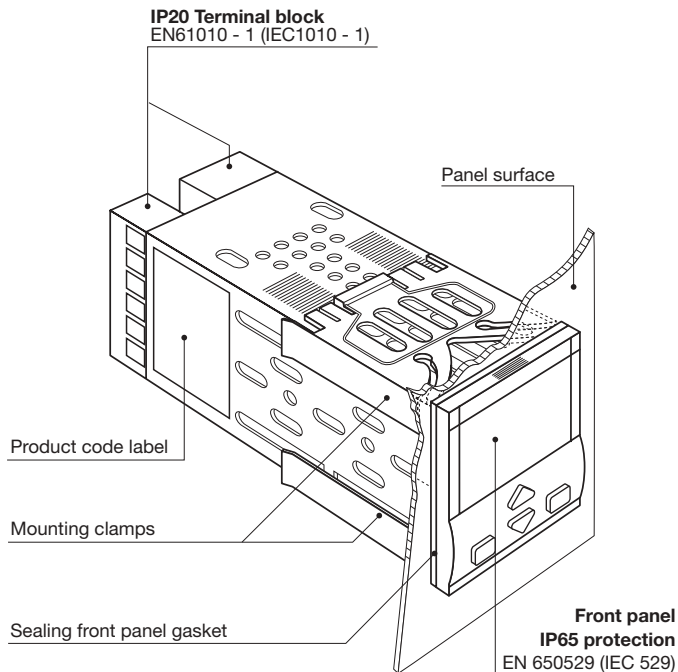

1.2 DIMENSIONAL DETAILS

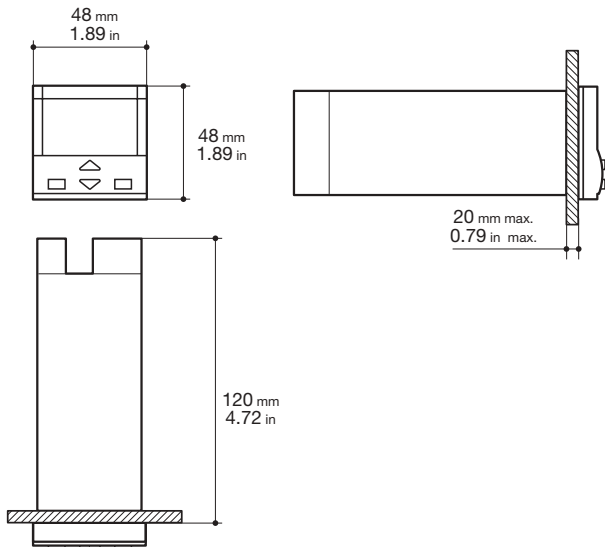

1.3 PANEL CUT-OUT

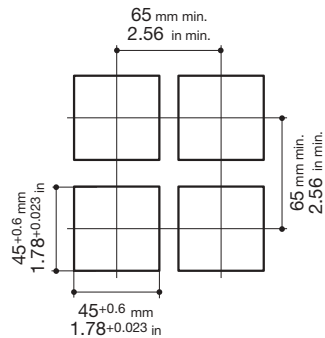

1.4 ENVIRONMENTAL RATINGS



Operating conditions



Altitude up to 2000 m



Temperature 0...50°C [1]

%Rh

Relative humidity 5...95% non-condensing

Special conditions

Suggestions



Altitude > 2000 m

Use 24Vac supply version



Temperature >50°C

Use forced air ventilation

%Rh

Humidity > 95 %

Warm up



Conducting atmosphere

Use filter

Forbidden Conditions



Corrosive atmosphere



Explosive atmosphere

UL note

[1] Operating surrounding
temperature 0...50°C

1.5 PANEL MOUNTING [1]

1.5.1 INSERT THE INSTRUMENT

- 1 Prepare panel cut-out
- 2 Check front panel gasket position
- 3 Insert the instrument through the cut-out

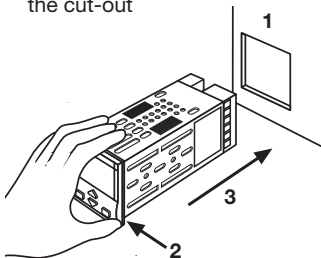

UL note

[1] For Use on a Flat Surface of a Type 2 and Type 3 'raintight' Enclosure.

1.5.2 INSTALLATION SECURING

- 1 Position the mounting clamps
- 2 Push the mounting clamps towards the panel surface to secure the instrument

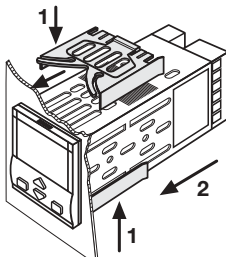

1.5.3 CLAMPS REMOVING

- 1 Insert the screwdriver in the clips of the clamps
- 2 Rotate the screwdriver

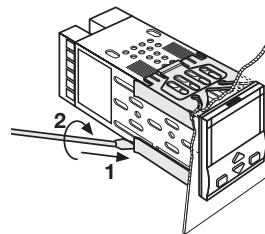

1.5.4 INSTRUMENT UNPLUGGING



- 1 Push and
- 2 pull to remove the instrument

Electrostatic discharges can damage the instrument
Before removing the instrument the operator must discharge himself to ground

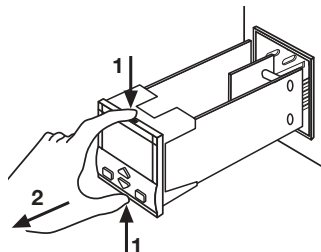
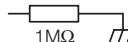

ELECTRICAL CONNECTIONS

2.1 TERMINAL BLOCK [1]

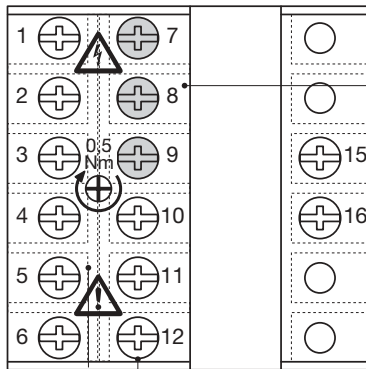
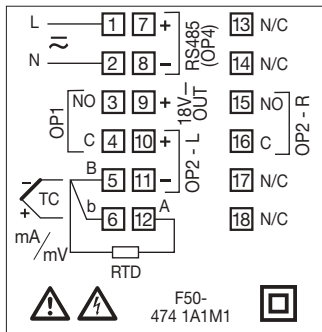

Rear terminal cover

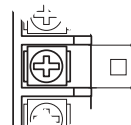

5.7 mm
 0.22 in
 Wire size 1 mm²
 (18 AWG Solid/
 Stranded) [2]

Terminals



14 screw terminals



Option terminals



Tightening torque
0.5 Nm



Phillips screwdriver
PH1



Flat blade screwdriver
0.8 x 4 mm

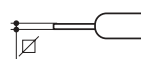

Pin connector
∅ 1.4 mm
0.055 in max.



Fork-shape
AMP 165004
∅ 5.5 mm - 0.21 in



Stripped wire
L 5.5 mm - 0.21 in

UL notes

[1] Use 60/70 °C copper (Cu) conductor only.

[2] Wire size 1 mm² (18 AWG Solid/Stranded)

PRECAUTIONS

Despite the fact that the instrument has been designed to work in an harsh and noisy environmental (level IV of the industrial standard IEC 801-4), it is strongly recommended to follow the following suggestions.



All the wiring must comply with the local regulations.

The supply wiring should be routed away from the power cables. Avoid to use electromagnetic contactors, power relays and high power motors nearby. Avoid power units nearby, especially if controlled in phase angle

Keep the low level sensor input wires away from the power lines and the output cables.

If this is not achievable, use shielded cables on the sensor input, with the shield connected to earth.

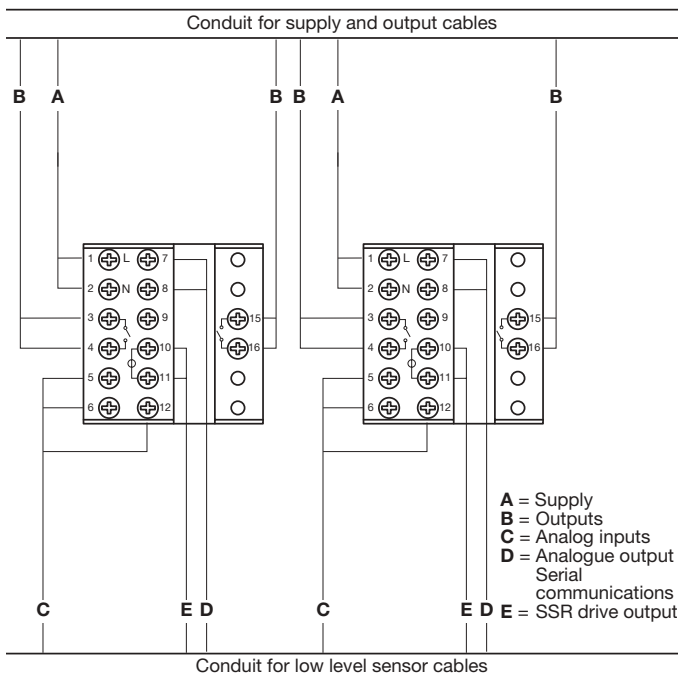
2.2 PRECAUTIONS AND ADVISED CONDUCTOR COURSE

2.3 EXAMPLE OF WIRING DIAGRAM

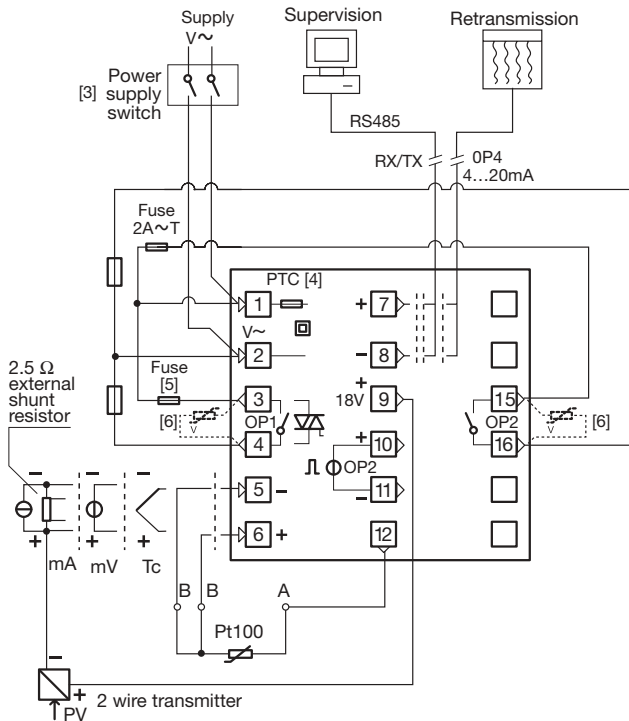
**Notes:**

- 1) Make sure that the power supply voltage is the same indicated on the instrument.
- 2) Switch on the power supply only after that all the electrical connections have been completed.
- 3) In accordance with the safety regulations, the power supply switch shall bring the identification of the relevant instrument. The power supply switch shall be easily accessible from the operator.
- 4) The instrument is PTC protected. In case of failure it is suggested to return the instrument to the manufacturer for repair.
- 5) To protect the instrument internal circuits use:
 - 2 AT/250Vac (4AT/120Vac) fuses for Relay outputs
 - 1 A~ T fuses for Triac outputs
- 6) Relay contacts are already protected with varistors.

Only in case of 24 Vac inductive loads, use model A51-065-30D7 varistors (on request)

2.3.1 POWER SUPPLY



Switching power supply with multiple isolation and internal PTC

- Standard version:
Nominal voltage:
100...240Vac (-15...+10%)
frequency 50/60Hz
- Low Voltage version:
Nominal voltage:
24Vac (-25...+12%)
frequency 50/60Hz
or 24Vdc (-15...+25%)
- Power consumption 2.6W max.

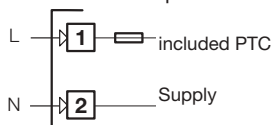

2.3.3 0P2 OUTPUT

- A] SSR drive output**, not isolated
0...5Vdc, $\pm 20\%$, 30mA max.

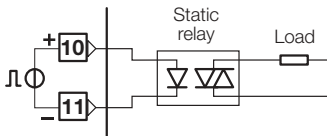

2.3.2 OP1 OUTPUT

**A] Single relay output**

- NO contact for resistive load of up to 2A/250Vac (4A/120Vac) max.
- Fuse 2AT/250Vac (4AT/120Vac) (IEC 127)

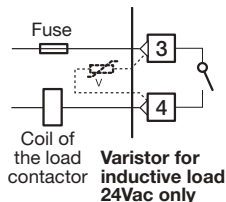
**B] Triac Output**

- NO contact for resistive load of up to 1A/250Vac max.
- Fuse 1A \sim T (IEC 127)

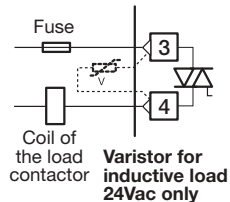
**B] Single relay output**

- NO contact for resistive load of up to 2A/250Vac (4A/120Vac) max.
- Fuse 2A \sim T (IEC 127)

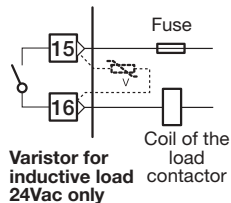

OP2 OUTPUT



OP2 output can be relay (Std) or SSR drive.

The “jumper” on the auxiliary board selects the output type:

Link Pins 1-2 for OP2-Relay

Link Pins 2-3 for OP2-SSR drive

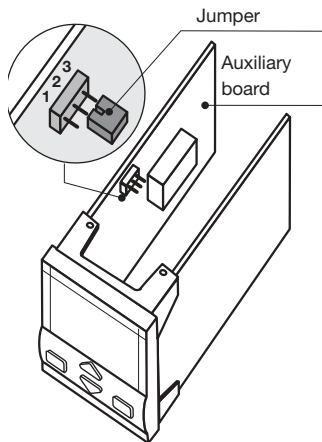

2.3.4 OP4 OUTPUT (option)



PV retransmission

- Galvanic isolation 500Vac/1 min
- 0/4...20mA (750Ω or 15Vdc max.)

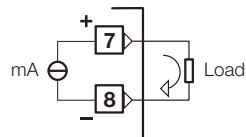

2.3.5 SERIAL COMMUNICATIONS (option)



- Galvanic isolation 500Vac/1 min
- Compliance to the EIA RS485 standard for Modbus/Jbus



Please, read:
gammadue® and **deltadue®**
controller series serial communication and configuration

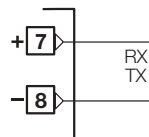



2.3.6 PV CONTROL INPUT

- Connect the wires with the polarity as shown
- Use always compensation cable of the correct type for the thermocouple used
- The shield, if present, must be connected to a proper earth.

For L J K S T thermocouple type

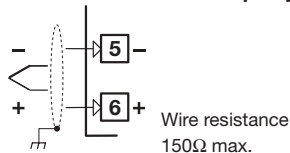

For mA, mV and V

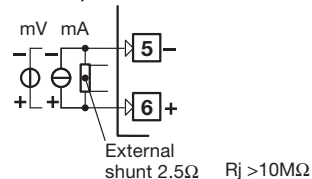

- If a 3 wires system is used, use always cables of the same size (1mm² min.) (line 20 Ω/lead maximum resistance)
- When using a 2 wires system, use always cables of the same size (1.5mm² min.) and put a jumper between terminals 5 and 6

For PT100 resistance thermometer

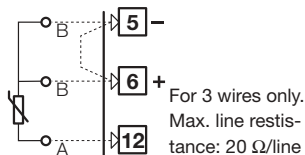

With 2 wire transducer

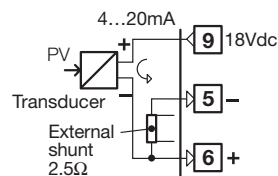

- ⚠ When the distance between the controller and the sensor is 15 m using a cable of 1.5 mm² size, produces an error on the measure of 1°C.

For ΔT (2 x RTD Pt100) Special

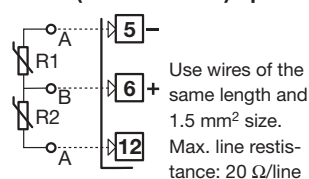

With 3 wire transducer

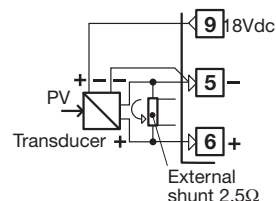

R1 + R2 must be < 320Ω

3 PRODUCT CODING

The complete code is shown on the instrument label. The informations about product coding are accessible from the front panel by mean of a particular procedure described at section 4.2.2 page 19

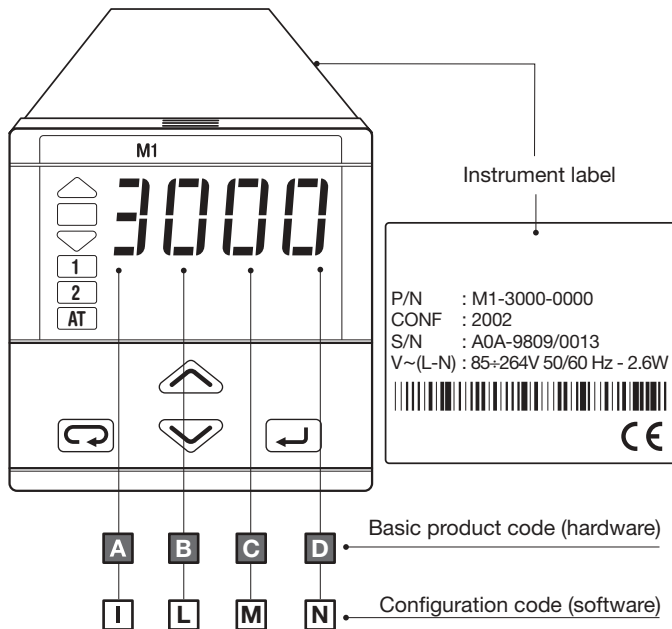

3.1 MODEL CODE

The product code indicate the specific hardware configuration of the instrument, that can be modified by specialized engineers only.

Line Basic Accessories Configur.
Model: **M 1** **A B C D** - **0 F G 0** / **I L M N**

Line		M	1
Power supply		A	
100...240Vac (-15...+10%)		3	
24Vac (-25...+12%) or 24Vdc (-15...+25%)		5	
OP1 Output		B	
Relay		0	
Triac		3	
Serial Communications	Options	C	D
Not fitted	None	0	0
	Transmitter Power Supply (P.S.)	0	6
	Transmitter P.S. + Retransmission	0	7
RS485	None	5	0
Modbus/Jbus protocol	Transmitter Power Supply	5	6
User manual		F	
Italian/English (std)		0	
French/English		1	
German/English		2	
Spanish/English		3	
Front panel colour		G	
Dark (std)		0	
Beige		1	

3.2 CONFIGURATION CODING

The configuration code consists of 4 digits that identify the operating characteristic of the controller, as chosen by the user.

Section 4.5 at pag. 26 reports the instructions how to set a new configuration code.

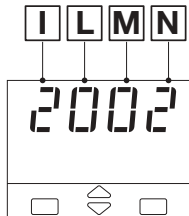

The configuration code can be displayed on the front panel, following the instructions at pag 19 section 4.2.2.

Input type and range			I
TR Pt100 IEC751	-99.9...300.0 °C	-99.9...572.9 °F	0
TR Pt100 IEC751	-200...600 °C	-328...1112 °F	1
TC L Fe-Const DIN43710	0...600 °C	32...1112 °F	2
TC J Fe-Cu45% Ni IEC584	0...600 °C	32...1112 °F	3
TC T Cu-CuNi	-200 ...400 °C	-328...752 °F	4
TC K Chromel-Alumel IEC584	0...1200 °C	32...2192 °F	5
TC S Pt10%Rh-Pt IEC584	0...1600 °C	32...2912 °F	6
DC input 0...50 mV, linear	engineering units		7
DC input 10...50 mV, linear	engineering units		8
Custom input and range			9

Control mode	Output configuration	L
PID	Control OP1 / alarm AL2 on OP2	0
	Control OP2 / alarm AL2 on OP1	1
ON - OFF	Control OP1 / alarm AL2 on OP2	2
	Control OP2 / alarm AL2 on OP1	3
2 alarms indicator	Alarm AL1 on OP1/ alarm AL2 on OP2	4
	Alarm AL1 on OP2/ alarm AL2 on OP	5

Type of control and safety		M
Reverse (AL1 active low)	Safety 0%	0
Direct (AL1 active high)	Safety 0%	1
Reverse (AL1 active low)	Safety 100%	2
Direct (AL1 active high)	Safety 100%	3



If, when the controller is powered up for the first time, the display shows the following message

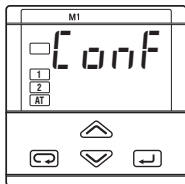

it means that the controller has not been configured yet. The controller remains in stand-by until the configuration code is set correctly (see chapter 4.6 pag 26).

Alarm 2 type and function		N
Not active		0
Sensor break alarm		1
Absolute	active high	2
	active low	3
Deviation [1]	active high	4
	active low	5
Deviation band [1]	active out (of the band)	6
	active in (the band)	7



Note

[1] Choice not available when the controller has been configured as 2 alarms indicator (L digit assigned to 4 or 5)

4 OPERATIONS

4.1 KEYPAD COMMANDS AND DISPLAY

• Deviation indicator (SP-PV)

	Green led ON OK	±1%
	Green led ON + 1 red led ON	±2%
	Only red led ON	>2%

OP1 output ON (red)

OP2 output ON (red)

Tune running (green)

• PV control input (operator mode)

(in engineering units)
when the measured value is greater
than sensor high range

0000

when the measured value is less than
the sensor low range

0000

• Code and/or value of the Parameter (programming mode)

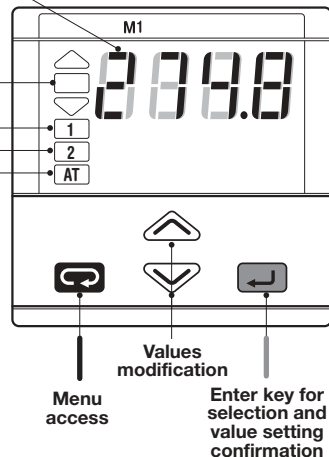

4.2 DISPLAY

When the display operation is selected, the controller presents automatically all the most important parameters and configuration information.

During the operation, the parameters values cannot be modified by the user

After 2 s from the end of the operation, the controller flashes the display and returns to the normal operating conditions.

Note

[1] See page 27

[2] This display is not presented if the instrument has been configured as an On - Off controller

4.2.1 OF THE PROCESS VARIABLES

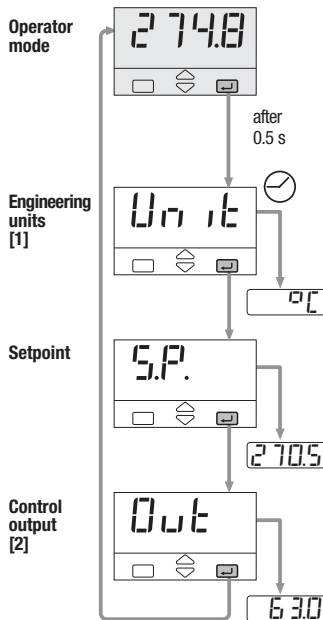

4.2.2 OF THE CONFIGURATION CODES

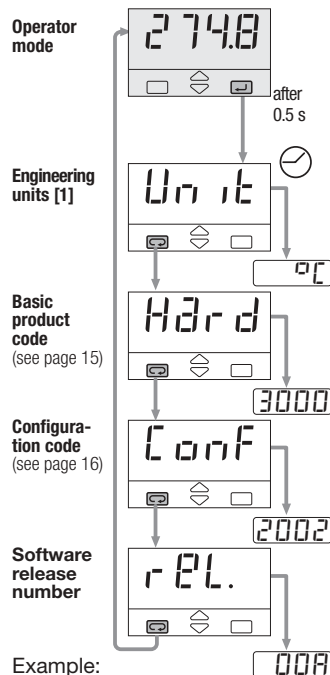



Example:



M1 - 3000 - 2002 / Release 00A

4.3 PARAMETER SETTING

4.3.1 NUMERIC ENTRY

(i.e. the modification of the value of a stored Setpoint from 275.0 to 240.0)

Press  or  momentarily to change the value of 1 unit every push



Continued pressing of  or  changes the value, at rate that doubles every second. Releasing the button the rate of change decreases.

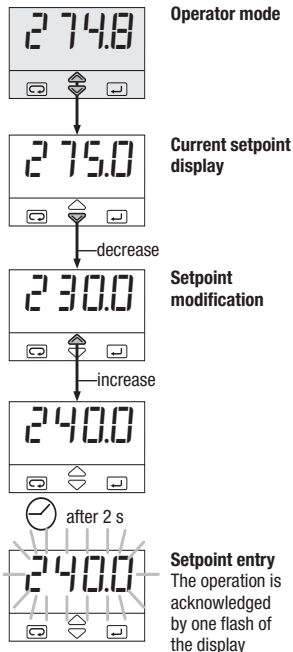

In any case the change of the value stops when it has reached the max./min. limit set for the parameter.



4.3.2 MNEMONIC CODES SETTING

(e.g. configuration see pages 26, 27)

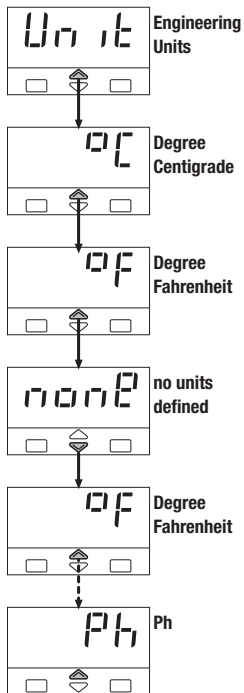

Press the  or  to display the next or previous mnemonic for the selected parameter.

Continued pressing of  or  will display further mnemonics at a rate of one mnemonic every 0.5 s. The mnemonic displayed at the time the next parameter is selected, is the one stored in the parameter.



4.4 SPECIAL FUNCTIONS

4.4.1 KEYPAD LOCK

To lock/unlock the keypad press the keys  and  simultaneously for 2 seconds.

To confirm the keypad lock/unlock the display flashes once.

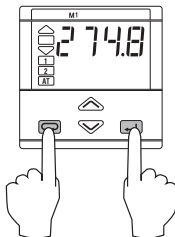



operator mode

Press simultaneously
for 2 seconds

The keypad lock/unlock can be achieved by serial communications too.

⚠ The keypad lock is maintained in case of power failure.

4.4.2 OUTPUTS LOCK

The outputs are switched to the OFF status by pressing the keys  and  together.

To unlock the outputs press again the keys simultaneously.

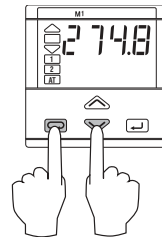

The outputs lock/unlock can be achieved by serial communications too.

⚠ The outputs lock/unlock is maintained in case of power failure.

4.4 PARAMETERIZATION

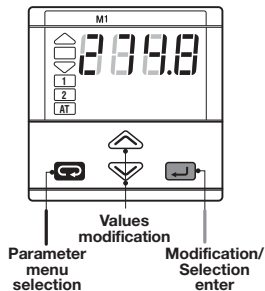

The parameter setting procedure has a timeout. If no keys are pressed for, at least, 30 seconds, the controller switches back, automatically, to the operator mode.

After having selected the parameter or the code, press and to display or modify the value (see pag. 20) The value is entered when the next parameter is selected, by pressing the key.

Pressing the key, the next group of parameters is presented on the display.

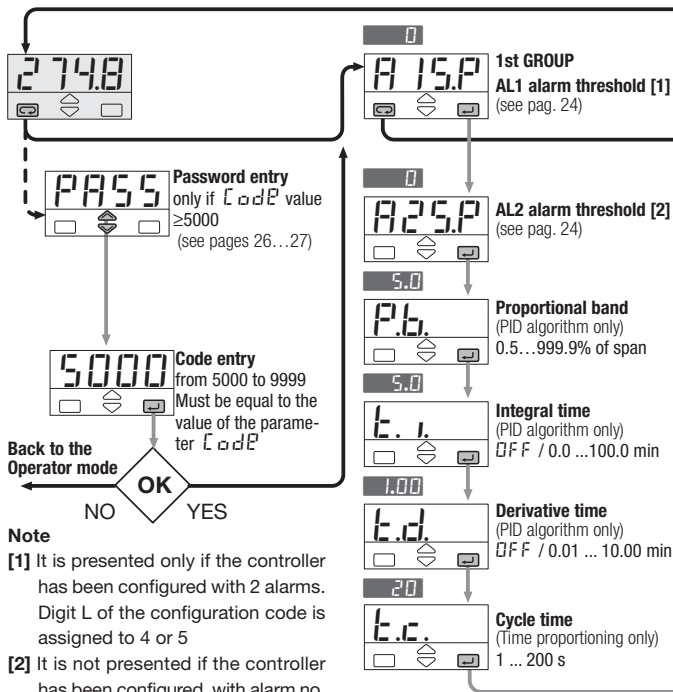

PARAMETER MENU

2nd GROUP
Tune run/stop
(PID algorithm only)

Password entry
only if Code
value <5000
(see pages 26...27)

Direct access
to the configuration
(pages 26 ... 27)

OFF
SL. u
Setpoint ramp up
(not available with 2 alarms)
OFF / 0.1...999.9 digit/min

OFF
SL. d
Setpoint ramp down
(not available with 2 alarms)
OFF / 0.1...999.9 digit/min

L. range
SP. L
Setpoint low limit
(not available with 2 alarms)
low range ... SP. H

H. range
SP. H
Setpoint high limit
(not available with 2 alarms)
SP. L...high range

0.5
AL1 hysteresis
0.1...10.0% of the span
[1]

0.5
AL2 hysteresis
0.1...10.0% of the span
[2]

OFF
t.F. IL
Filter time constant
OFF / 1...30 s

0
Input shift
OFF / -60 ... 60 digits

1
Addr
Communication address
(if option installed)
OFF / 1...247

L. range
rtLo
Retransmission
low range
(if option installed)
full scale

H. range
rtHi
Retransmission
high range
(if option installed)
full scale

1.00
OC.
Overshoot control
(PID algorithm only)
0.01...1.00

100.0
OP. H
Control output high limit
(PID algorithm only)
10.0...100.0%

0.5
hy.
Control output
hysteresis
(ON-OFF control only)
0.1... 10.0% of span

Back to the 1st parameter group

Back to the 1st parameter of the 2nd group

4.5 PARAMETER

1st GROUP

The controller parameters have been organized in group, according to their functionality area.

A 15.P AL1 alarm threshold

The threshold is presented only if the controller have been configured with 2 alarms. (Digit L of the configuration code assigned to 4 or 5)

A 25.P AL2 alarm threshold

The alarm occurrences handle the OP1 and OP2 outputs, in different ways, according to the configured types of alarms, as illustrated.

P.b. Proportional band

This parameter specifies the proportional band coefficient that multiplies the error (SP - PV)

I. I. Integral time

It is the integral time value, that

Sensor break or input disconnection

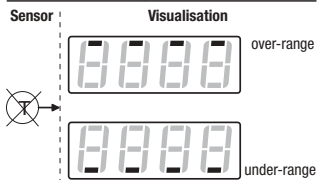

Absolute alarm (full scale)

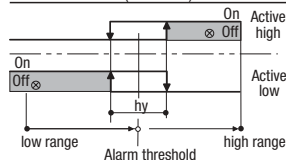

Deviation alarm

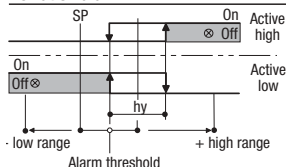

Band alarm

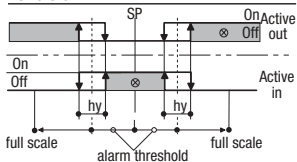

specifies the time required by the integral term to generate an output equivalent to the proportional term. When *OFF* the integral term is not included in the control algorithm.

D.d. Derivative time

It is the derivative term coefficient that specifies the time required by the proportional term P to reach the level of D. When *OFF* the derivative term is not included in the control algorithm.

C.c. Control output cycle time

It's the cycle time of the time proportioning control output. The PID control output is provided through the pulse width modulation of the digital waveform.

O.C. Overshoot control

This parameter specifies the span of action of the overshoot control. Setting lower values (0.99 \rightarrow 0.01) the overshoot generated by a Setpoint change is reduced. The overshoot control doesn't affect the

effectiveness of the PID algorithm. Setting 1, the overshoot control is disabled.

OP. H

Control output high limit

It specifies the maximum value the control output can be set

69.

Control output hysteresis

Hysteresis of the threshold

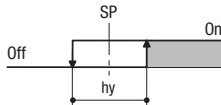

Control output hysteresis span, set in % of the full scale.

2nd GROUP

SL. u

Setpoint ramp up

SL. d

Setpoint ramp down

This parameter specifies the maximum rate of change of the Setpoint in digit/min. When the parameter is \overline{FFF} , this function is disabled.

S.P. L

Setpoint low limit

Low limit of the setpoint value. When the parameter is \overline{FFF} , this function is disabled.

S.P. H

Setpoint high limit

High limit of the setpoint value. When the parameter is \overline{FFF} , this function is disabled.

AL1

AL1 alarm hysteresis

AL2

AL2 alarm hysteresis

Hysteresis of the threshold of both the alarms, that activate OP1 and OP2 control output. It is specified as a % of the full scale.

t.FI

Input filter time constant

Time constant, in seconds, of the RC input filter applied to the PV input. When this parameter is set to \overline{FFF} the filter is bypassed.

Filter response

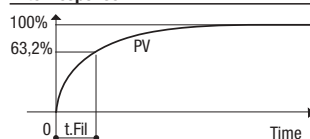

In.Sh

Input shift

This value is added to the measured PV input value. Its effect is to shift the whole PV scale of up to ± 60 digits.

Addr

Controller address

the address range is from 1 to 247 and must be unique for each controller on the communication bus to the supervisor. When set to \overline{FFF} the controller is not communicating

r.tLo

Retransmission low range

r.tHi

Retransmission high range

These parameters define the range of the OP4 retransmission output. Example: 4...20 mA output corresponding to 20...120°C.

4.6 CONFIGURATION

The configuration of the controller is specified through a 4 digit code that defines the type of input, of control output and of the alarms. (sect. 3.2 pag16)

Other parameters specify the type of auxiliary functions.

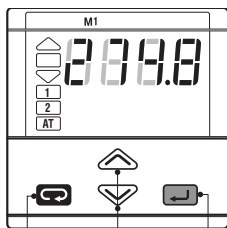

Parameter menu selection

Values modification

Modification/ Selection enter

Press or to display the next parameter or the next code and change its value.

The new value entered is stored into the controller when the next parameter is selected by pressing .

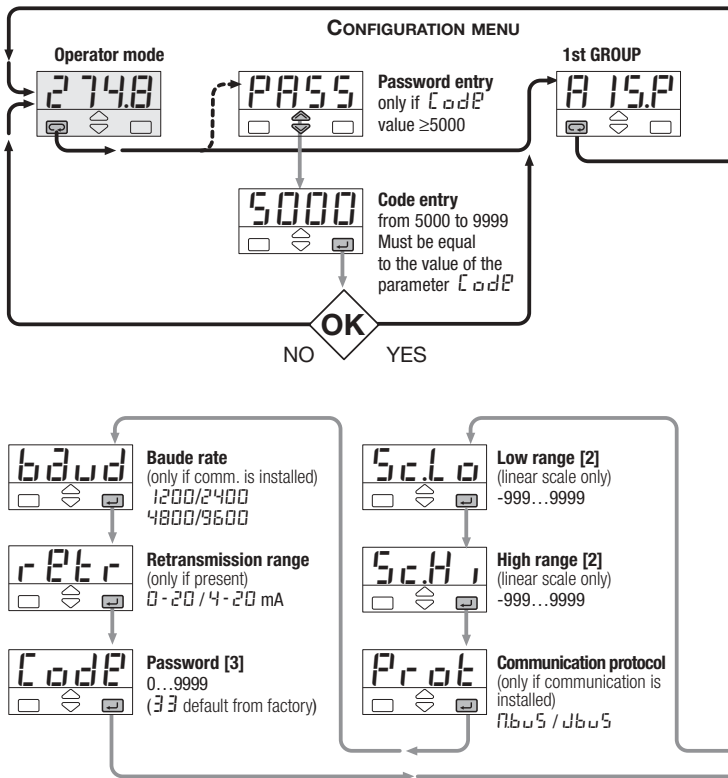

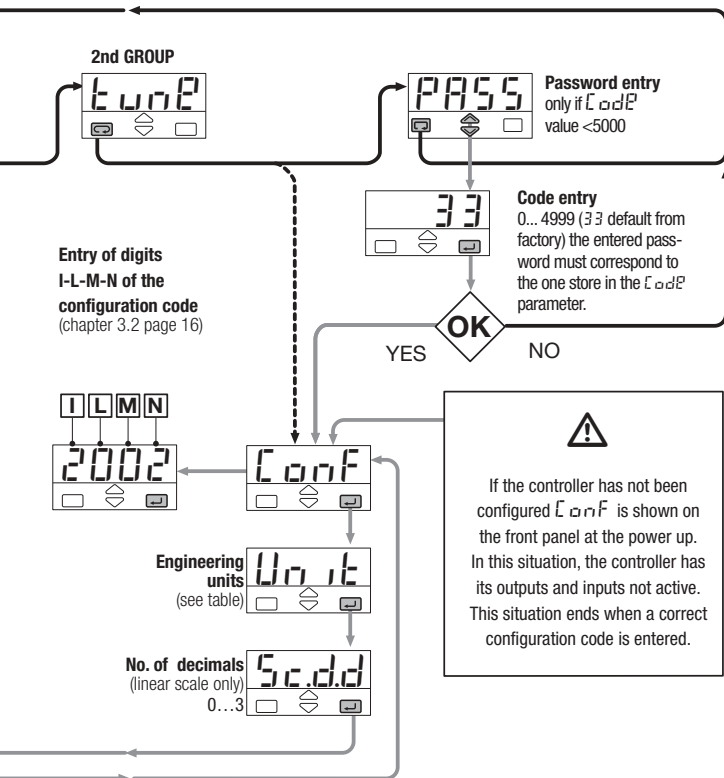
**Note:**

Pressing the the next group of parameters is displayed.

[1] Table of the supported Engineering Units.

Centigrade degrees *	°C
Fahrenheit degrees *	°F
none	none
mV	mV
Volt	V
mA	mA
Ampere	A
Bar	bar
PSI	PSI
Rh	rh
pH	pH

* For inputs from thermocouple or resistance thermometer, the choice is between °C and °F only.

[2] Range of min 100 digits.

[3] To avoid free parameter access insert 5000... 9000.

5 AUTOMATIC TUNE

Start/stop of the Fuzzy Tuning
The Tuning operation can be started or stopped any time.

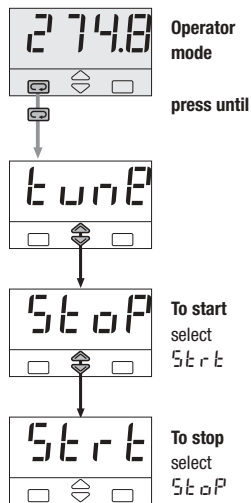

The green led **[AT]** goes on when the Fuzzy Tuning is in progress. At the end of this operation, the calculated PID terms parameter are stored and used by the control algorithm and the controller goes back to the operator mode. The green led **[AT]** becomes off.

This function allows the calculation of the optimal PID terms parameters, monitoring the response of the process to disturbances.

The controller provides 2 types of "one shot" tuning algorithm, that are selected automatically according to the process condition when the operation is started.

Step response

This type is selected when, at the start of the autotune operation, the PV is far from the Setpoint of more than 5% of the span.

This method has the big advantage of fast calculation, with a reasonable accuracy in the term calculation.

Natural frequency

This type is selected when the PV is close to the SP point.

This method has the advantage of a better accuracy in the term calculation with a reasonable speed calculation.

The Fuzzy Tuning determines automatically the best method to use to calculate the PID term, according to the process conditions.

Step response

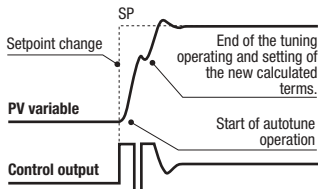

Natural frequency

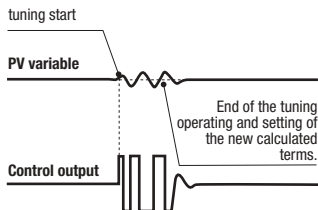

6 TECHNICAL SPECIFICATIONS

Features (at 25°C environmental temp.)	Description			
Total configurability see par. 3.2 pag. 16 par. 4.6 pag. 26	From keypad or serial communication the user selects: the type of input - the associated functions and the corresponding outputs - the type of control algorithm - the type of output and the safe conditions - the type and functionality of the alarms - the values of all the control parameters.			
PV Input (see pag.13 and pag. 16)	Common characteristics	A/D converter with resolution of 50000 points Update measurement time: 0.2 seconds Sampling time: 0.5 seconds Input bias: - 60...+ 60 digit Input filter with enable/disable: 1...30 seconds		
	Accuracy	0.25% ±1 digits for temperature sensors 0.1% ±1 digits (for mV and mA)	Between 100...240Vac the error is minimal	
	Resistance thermometer	Pt100Ω at 0°C (IEC 751) °C/°F selectable	2 or 3 wires connection	Max. wire Resistance: 20Ω (3 wires) Input drift: 0.35°C/10° Env. Temp. <0.35°C/10Ω Wire Res.
	Thermocouple	L, J, T, K, S (IEC 584) °C/°F selectable	Internal cold junction compensation in °C/°F	Max. wire Res.: 150Ω max. Input drift: <2µV/°C Env. Temp. <5µV/10Ω Wire Res.
	DC input (current)	4...20mA, 0...20mA with 2.5Ω external shunt Rj >10MΩ	Engineering units Conf. decimal point position Init. Sc. -999...9999	Input drift: <0.1%/20°C Env. Temp.
	DC input (voltage)	10...50mV, 0...50mV Rj >10MΩ	Full Sc. -999...9999 (min. range of 100 digits)	
Error indicator	By led with green led when error <1% (see page 18)			

Features (at 25°C environmental temp.)	Description				
Operating mode and Outputs	Indicator with 2 alarms	AL1 alarm		AL2 alarm	
		OP1 - relay or Triac	OP2 - SSR drive or relay		
	OP2 - SSR drive or relay	OP1 - relay or Triac			
	1 PID loop or 1 ON-OFF loop with 1 Alarm	Control output		AL2 alarm	
OP1 - relay or Triac		OP2 - SSR drive or relay			
OP2 - SSR drive or relay		OP1 - relay or Triac			
Control mode	Algorithm		PID with overshoot control or ON OFF		
	Proportional band (P)		0.5...999.9%		
	Integral time (I)		0.1...100.0 min	OFF = 0	PID algorithm
	Derivative time (D)		0.01...10.00 min		
	Cycle time		1...200 s		
	Overshoot control		0.01...1.00		
	High limit		100.0...10.0%		
Hysteresis		0.1...10.0%		ON-OFF algorithm	
OP1 output	SPST relay N.O., 2A/250Vac (4A/120Vac) for resistive load Triac, 1A/250Vac for resistive load				
OP2 output	SSR drive, not isolated: 5Vdc, ± 10%, 30mA max. SPST relay N.O., 2A/250Vac (4A/120Vac) for resistive load				
AL1 alarm (indicator with 2 alarms)	Hysteresis 0.1...10.0% full scale				
	Active high		Absolute threshold: full scale		
	Active low				
AL2 alarm	Hysteresis 0.1...10.0% c.s.				
	Action	Active high	Action type	Deviation threshold	±range
		Active low		band threshold	0...range
		Special function		Absolute threshold	whole range
Special function	Sensor break				











Features (at 25°C environmental temp.)	Description		
Setpoint	Ramp up and down. User inhibited	0.1...999.9 digit/min (OFF = 0)	
	Low limit	From low range to the high limit	
	High limit	From low limit to the high range	
OP4 PV retransmission (option)	Galvanic isolation: 500 Vac/1 min Resolution: 12bit (0.025%) Accuracy: 0.1 %	Current output: 0/4...20mA 750Ω/15V max.	
One shot Fuzzy-Tuning with automatic selection	The controller selects automatically the best method according to the process conditions	Step method	
Serial comm. (option)		Natural frequency method	
Auxiliary Supply	RS485 isolated, Modbus/Jbus protocol, 1200, 2400, 4800, 9600 bit/s 2 wires		
Operational safety	Measure input	Detection of out of range, short circuit or sensor break with automatic activation of the safety strategies and alerts on display	
	Control output	Safety value: 0...100%. (user enabled/disabled)	
	Parameters	Parameter and configuration data are stored in a non volatile memory for an unlimited time	
	Access protection	Password to access the configuration and parameters data	
General characteristics	Power supply	100...240Vac (-15...+10%) 50/60Hz or 24Vac (-25...+12%) 50/60Hz and 24Vdc (-15...+25%)	
	Electric safety	Compliance to EN61010, installation class 2 (2.5kV) pollution class 2	
	Electromagnetic compatibility	Compliance to the CE standards for industrial system and equipment	
	UL and cUL approvals	File 176452	
	Protection EN650529	IP20 terminal block IP65 front panel	
Dimensions	1/16 DIN - 48 x 48, depth 120 mm, weight 130 g approx.		













■ **WARRANTY**











We warrant that the products will be free from defects in material and workmanship for 18 months from the date of delivery.

The warranty above shall not apply for any failure caused by the use of the product not in accordance with the instructions contained in this manual.

ICONS TABLE

Main universal input	
	Thermocouple
	RTD (Pt100)
	Delta Temp (2x RTD)
	mA and mV
	Custom
	Frequency
Auxiliary input	
	Current transformer
	mA Remote setpoint
	Volt Remote setpoint
	Feedback potentiometer

Digital input	
	Isolated contact
	NPN open collector
	TTL open collector
Setpoint	
	Local
	Stand-by
	Keypad lock
	Outputs lock
	Start-up function
	Timer function
	Memorized
	Remote
	Setpoint programmer

Digital input connected functions	
	Auto/Manual
	Run, Hold, Reset and program selection
	PV hold
	Setpoint slopes inhibition
Output	
	SPST Relay
	Triac
	SPDT Relay
	mA
	mA mV
	SSR drive