



DS60-N31311

Dx60

MID RANGE DISTANCE SENSORS

SICK
Sensor Intelligence.



Ordering information

Type	Part no.
DS60-N31311	1016694

Other models and accessories → www.sick.com/Dx60



Detailed technical data

Performance

Measuring range	80 mm ... 6,000 mm, 90 % remission ¹⁾ 80 mm ... 4,600 mm, 18 % remission ¹⁾ 80 mm ... 2,400 mm, 6 % remission ¹⁾
Response time	10 ms
Switching frequency	50 Hz
Light source	Laser, infrared
Laser class	1 (EN 60825-1)
Typ. light spot size (distance)	12 mm x 12 mm (at 6 m)
Additional function	Invertable switching output, ObSB mode
Average laser service life (at 25 °C)	50,000 h

¹⁾ Teach-in from 200 ... 6,000 mm.

Interfaces

Switching output	2x NPN (100 mA) ^{1) 2)}
-------------------------	----------------------------------

¹⁾ Output Q short-circuit protected.

²⁾ NPN: HIGH = < 2.5 V / LOW = V_S.

Mechanics/electronics

Supply voltage V_s	DC 18 V ... 30 V ¹⁾
Ripple	≤ 5 V _{pp} ²⁾
Power consumption	≤ 3 W ³⁾
Connection type	Male connector, M12, 5-pin
Weight	202 g
Enclosure rating	IP 67

¹⁾ Limit values, reverse-polarity protected, operation in short-circuit protected network: max. 8 A.

²⁾ May not fall short of or exceed V_S tolerances.

³⁾ Without load.

Protection class	II
-------------------------	----

- 1) Limit values, reverse-polarity protected, operation in short-circuit protected network: max. 8 A.
- 2) May not fall short of or exceed V_S tolerances.
- 3) Without load.

Ambient data

Electromagnetic compatibility (EMC)	EN 61000-6-2 EN 60947-5-2
Ambient temperature	Operation: -25 °C ... +55 °C Storage: -25 °C ... +75 °C

Classifications

ECl@ss 5.0	27270801
ECl@ss 5.1.4	27270801
ECl@ss 6.0	27270801
ECl@ss 6.2	27270801
ECl@ss 7.0	27270801
ECl@ss 8.0	27270801
ECl@ss 8.1	27270801
ECl@ss 9.0	27270801
ETIM 5.0	EC001825
ETIM 6.0	EC001825
UNSPSC 16.0901	41111613

Dimensional drawing (Dimensions in mm (inch))

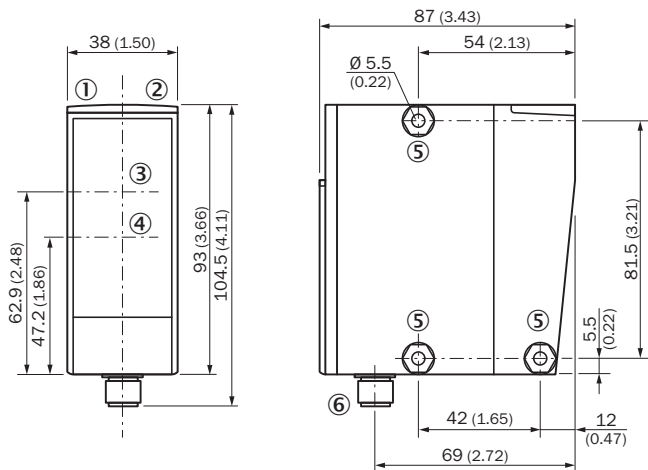

- ① Status indicator switching output 1
- ② Status indicator switching output 2
- ③ Optical axis sender
- ④ Optical axis receiver
- ⑤ Mounting hole, \varnothing 5.2 mm
- ⑥ Male connector M12, 5-pin

Connection type

Male connector M12, 5-pin

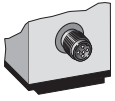

Connection diagram



Adjustment possible

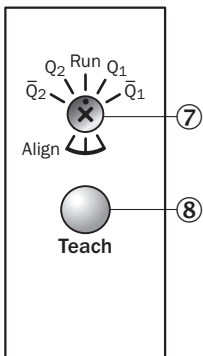

- ⑦ Rotary switch
- ⑧ Control element

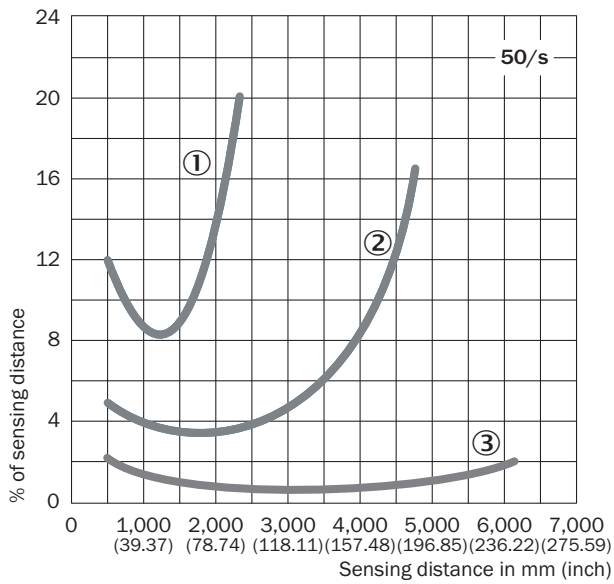

Sensing distance



- ① 6 % / 90 %
- ② 18 % / 90 %
- ③ 90 % / 90 %

Recommended accessories

Other models and accessories → www.sick.com/Dx60

	Brief description	Type	Part no.
Mounting brackets and plates			
	Mounting bracket, steel, zinc coated, without mounting hardware	BEF-WN-DS60	4032937
Plug connectors and cables			
	Head A: female connector, M12, 5-pin, straight Head B: cable Cable: PVC, unshielded, 2 m	DOL-1205-G02M	6008899
	Head A: female connector, M12, 5-pin, straight Head B: cable Cable: PVC, unshielded, 5 m	DOL-1205-G05M	6009868
	Head A: female connector, M12, 5-pin, straight Head B: cable Cable: PVC, unshielded, 10 m	DOL-1205-G10M	6010544
	Head A: female connector, M12, 5-pin, angled Head B: cable Cable: PVC, unshielded, 2 m	DOL-1205-W02M	6008900
	Head A: female connector, M12, 5-pin, angled Head B: cable Cable: PVC, unshielded, 5 m	DOL-1205-W05M	6009869

1) Customizable length by sheet. Width max. 74.9 cm, length max. 91.4 cm.

	Brief description	Type	Part no.
	Head A: female connector, M12, 5-pin, angled Head B: cable Cable: PVC, unshielded, 10 m	DOL-1205-W10M	6010542
Reflectors			
	"Diamond grade" reflective tape, self-adhesive, ready to assemble from the sheet, 74.9 cm x 91.4 cm ¹⁾ , self-adhesive	REF-DG-K	4019634

¹⁾ Customizable length by sheet. Width max. 74.9 cm, length max. 91.4 cm.

SICK AT A GLANCE

SICK is one of the leading manufacturers of intelligent sensors and sensor solutions for industrial applications. A unique range of products and services creates the perfect basis for controlling processes securely and efficiently, protecting individuals from accidents and preventing damage to the environment.

We have extensive experience in a wide range of industries and understand their processes and requirements. With intelligent sensors, we can deliver exactly what our customers need. In application centers in Europe, Asia and North America, system solutions are tested and optimized in accordance with customer specifications. All this makes us a reliable supplier and development partner.

Comprehensive services complete our offering: SICK LifeTime Services provide support throughout the machine life cycle and ensure safety and productivity.

For us, that is “Sensor Intelligence.”

WORLDWIDE PRESENCE:

Contacts and other locations –www.sick.com