



DS40-P21211

DS40

MID RANGE DISTANCE SENSORS

SICK
Sensor Intelligence.



Ordering information

Type	Part no.
DS40-P21211	1029819

Other models and accessories → www.sick.com/DS40



Detailed technical data

Performance

Measuring range	80 mm ... 5,000 mm, 90 % remission ¹⁾ 80 mm ... 4,000 mm, 18 % remission ¹⁾ 80 mm ... 2,000 mm, 6 % remission ¹⁾
Response time	10 ms
Switching frequency	50 Hz
Light source	Laser, red
Laser class	2 (EN 60825-1)
Typ. light spot size (distance)	9 mm x 9 mm (at 4.5 m)
Additional function	Invertable switching output
Average laser service life (at 25 °C)	50,000 h

¹⁾ Teach-in from 200 ... 5,000 mm.

Interfaces

Switching output	1 x PNP (100 mA) ¹⁾
-------------------------	--------------------------------

¹⁾ Output Q short-circuit protected.

Mechanics/electronics

Supply voltage V_s	DC 11 V ... 30 V ¹⁾
Ripple	≤ 5 V _{pp} ²⁾
Power consumption	< 3 W ³⁾
Connection type	Male connector, M12, 5-pin
Weight	202 g
Enclosure rating	IP 67
Protection class	III

¹⁾ Limit values, reverse-polarity protected, operation in short-circuit protected network: max. 8 A.

²⁾ May not fall short of or exceed V_s tolerances.

³⁾ Without load.

Ambient data

Electromagnetic compatibility (EMC)	EN 61000-6-2 EN 60947-5-2
Ambient temperature	Operation: -25 °C ... +50 °C Storage: -25 °C ... +75 °C

Classifications

ECI@ss 5.0	27270801
ECI@ss 5.1.4	27270801
ECI@ss 6.0	27270801
ECI@ss 6.2	27270801
ECI@ss 7.0	27270801
ECI@ss 8.0	27270801
ECI@ss 8.1	27270801
ECI@ss 9.0	27270801
ETIM 5.0	EC001825
ETIM 6.0	EC001825
UNSPSC 16.0901	41111613

Dimensional drawing (Dimensions in mm (inch))

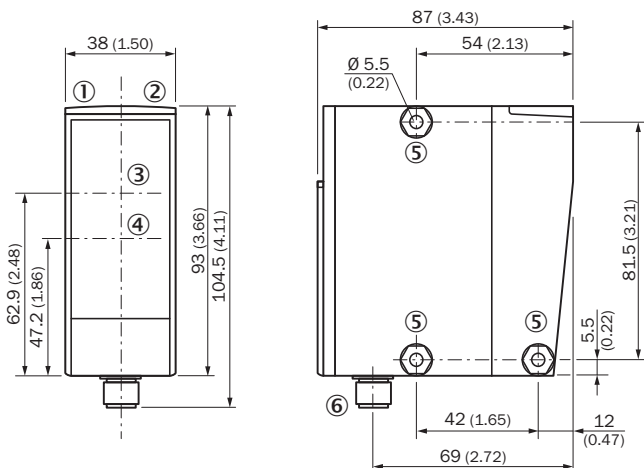

- ① Status indicator switching output (out)
- ② Operating indicator
- ③ Optical axis sender
- ④ Optical axis receiver
- ⑤ Mounting hole, \varnothing 5.2 mm
- ⑥ Male connector M12, 5-pin

Connection type

Male connector M12, 5-pin

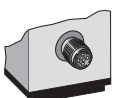

Connection diagram

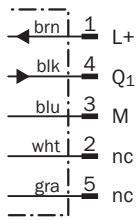

Adjustment possible

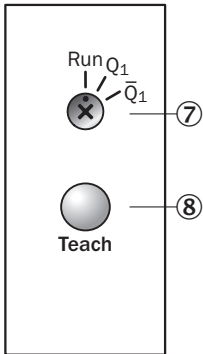

- ⑦ Rotary switch
- ⑧ Control element

Scanning range

Characteristic curve: sensing distance 50/s

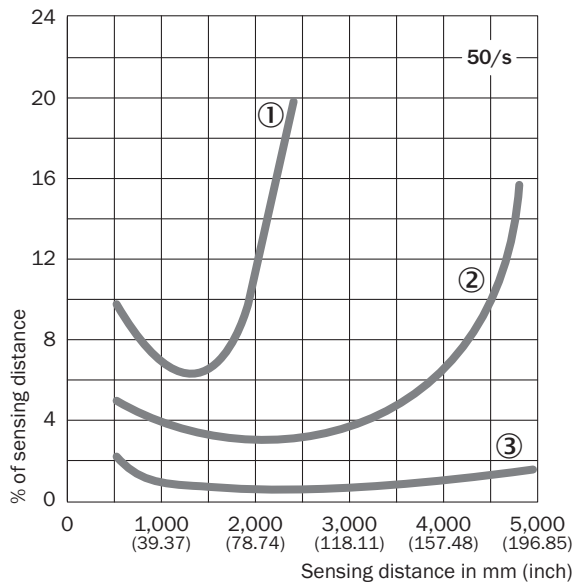

- ① Distance change from 6 % ... 90 % remission
- ② Distance change from 18 % ... 90 % remission
- ③ Distance change from 90 % ... 90 % remission

Characteristic curve: sensing distance 10/s

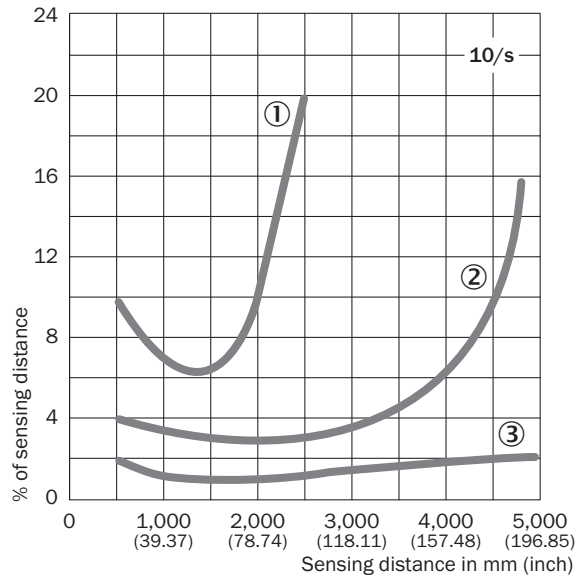

- ① Distance change from 6 % ... 90 % remission
- ② Distance change from 18 % ... 90 % remission
- ③ Distance change from 90 % ... 90 % remission

Recommended accessories

Other models and accessories → www.sick.com/DS40

	Brief description	Type	Part no.
Universal bar clamp systems			
	Plate K for universal clamp bracket, steel, zinc coated, universal clamp and mounting hardware included	BEF-KHS-K01	2022718
Mounting brackets and plates			
	Mounting bracket, steel, zinc coated, without mounting hardware	BEF-WN-DS60	4032937

SICK AT A GLANCE

SICK is one of the leading manufacturers of intelligent sensors and sensor solutions for industrial applications. A unique range of products and services creates the perfect basis for controlling processes securely and efficiently, protecting individuals from accidents and preventing damage to the environment.

We have extensive experience in a wide range of industries and understand their processes and requirements. With intelligent sensors, we can deliver exactly what our customers need. In application centers in Europe, Asia and North America, system solutions are tested and optimized in accordance with customer specifications. All this makes us a reliable supplier and development partner.

Comprehensive services complete our offering: SICK LifeTime Services provide support throughout the machine life cycle and ensure safety and productivity.

For us, that is “Sensor Intelligence.”

WORLDWIDE PRESENCE:

Contacts and other locations –www.sick.com