



DOL-1204-W05MN

SICK
Sensor Intelligence.



Ordering information

Type	Part no.
DOL-1204-W05MN	6028131

Other models and accessories → www.sick.com/

Detailed technical data

Technical specifications

Accessory group	Plug connectors and cables
Accessory family	Connecting cables
Connection type head A	Female connector, M12, 4-pin, angled
Connection type head B	Flying leads
Connection type	Flying leads
Connector material	PVC
Connector color	Orange
Locking nut material	Stainless steel (V4A/1.4404/316L)
Tightening torque	0.6 Nm
Cable	5 m, 4-wire, PVC
Jacket material	PVC
Jacket color	Orange
Cable diameter	Ø 5 mm
Conductor cross-section	0.25 mm ²
Shielding	Unshielded
Bending cycles	≥ 1,000,000
Reference voltage	≤ 250 V
Current loading	4 A
Application	Hygienic and washdown zones Drag chain operation
Enclosure rating	IP67/ IP69K
Ambient operating temperature	
Flexible use	+5 °C ... +80 °C
Stationary position	-40 °C ... +80 °C
Head	-25 °C ... +70 °C

Classifications

ECl@ss 5.0	19030312
ECl@ss 5.1.4	19030312
ECl@ss 6.0	27060304
ECl@ss 6.2	27060304

ECI@ss 7.0	27060304
ECI@ss 8.0	27060304
ECI@ss 8.1	27060304
ECI@ss 9.0	27060304
ETIM 5.0	EC000830
ETIM 6.0	EC000830
UNSPSC 16.0901	26121604

Dimensional drawing (Dimensions in mm (inch))

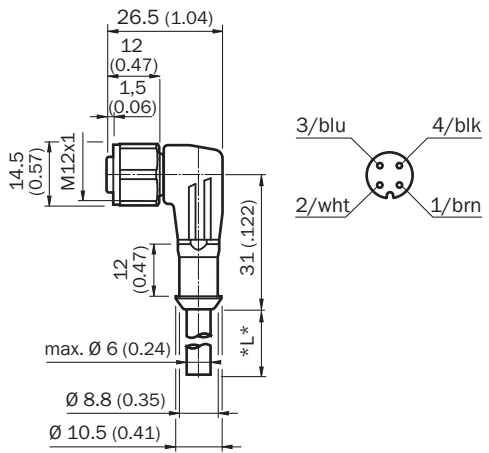

SICK AT A GLANCE

SICK is one of the leading manufacturers of intelligent sensors and sensor solutions for industrial applications. A unique range of products and services creates the perfect basis for controlling processes securely and efficiently, protecting individuals from accidents and preventing damage to the environment.

We have extensive experience in a wide range of industries and understand their processes and requirements. With intelligent sensors, we can deliver exactly what our customers need. In application centers in Europe, Asia and North America, system solutions are tested and optimized in accordance with customer specifications. All this makes us a reliable supplier and development partner.

Comprehensive services complete our offering: SICK LifeTime Services provide support throughout the machine life cycle and ensure safety and productivity.

For us, that is “Sensor Intelligence.”

WORLDWIDE PRESENCE:

Contacts and other locations –www.sick.com