



WTM160T-E492

PRODUCT PORTFOLIO

SICK
Sensor Intelligence.



Illustration may differ



Ordering information

Type	Part no.
WTM160T-E492	6020695

Other models and accessories → www.sick.com/

Detailed technical data

Features

Sensor/ detection principle	Photoelectric proximity sensor
Dimensions (W x H x D)	11 mm x 38 mm x 23 mm
Housing design (light emission)	Rectangular
Sensing range max.	8 mm ... 12 mm ¹⁾
Sensing range	8 mm ... 12 mm ¹⁾
Type of light	Visible green light
Light source	LED
Wave length	540 nm

¹⁾ Object with 90 % reflectance (referred to standard white, DIN 5033).

Mechanics/electronics

Supply voltage	10 V DC ... 30 V DC
Ripple	± 10 %
Power consumption	≤ 40 mA ¹⁾
Switching output	NPN
Switching mode	Light/dark switching
Switching mode selector	Selectable via light/dark rotary switch
Response time	≤ 0.2 ms ²⁾
Connection type	Connector M8, 4-pin
Housing material	Plastic, PBT
Optics material	Plastic, PMMA
Enclosure rating	IP69K
Ambient operating temperature	-25 °C ... +55 °C

¹⁾ Without load.

²⁾ Signal transit time with resistive load.

Ambient storage temperature	-40 °C ... +70 °C
UL File No.	NRNT2.E128350 & NRNT8.E128350

- 1) Without load.
- 2) Signal transit time with resistive load.

Adjustments possible

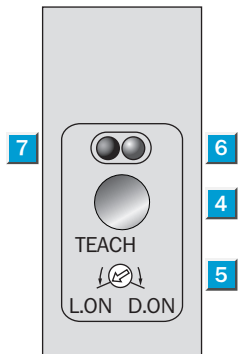

- ④ Teach-in button
- ⑤ Light/ dark rotary switch: L = light switching, D = dark switching
- ⑥ Orange LED indicator : switching output active
- ⑦ Green LED indicator: light reception with operating reserve >1.1

Connection diagram

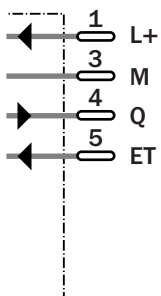

Characteristic curve

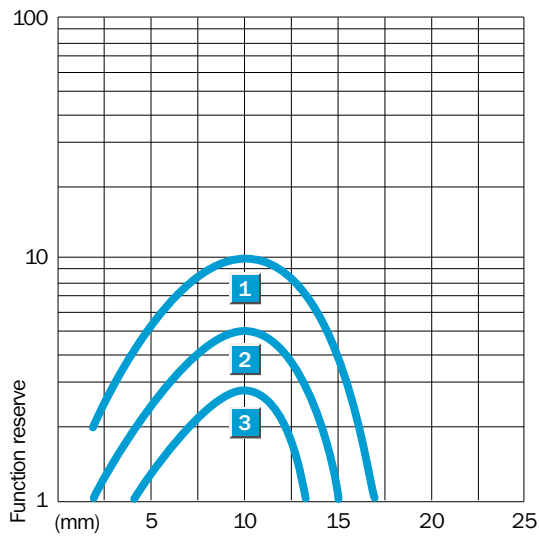

Dimensional drawing (Dimensions in mm (inch))

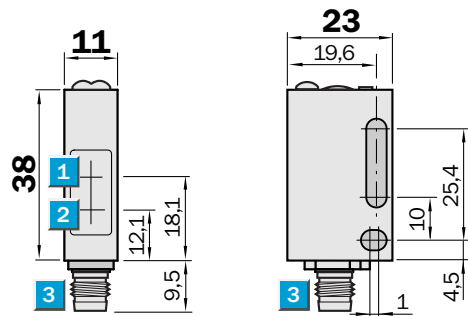

- ① Center of optical axis, receiver
- ② Center of optical axis, sender
- ③ Connector M8, 3/4-pin or connection cable

SICK AT A GLANCE

SICK is one of the leading manufacturers of intelligent sensors and sensor solutions for industrial applications. A unique range of products and services creates the perfect basis for controlling processes securely and efficiently, protecting individuals from accidents and preventing damage to the environment.

We have extensive experience in a wide range of industries and understand their processes and requirements. With intelligent sensors, we can deliver exactly what our customers need. In application centers in Europe, Asia and North America, system solutions are tested and optimized in accordance with customer specifications. All this makes us a reliable supplier and development partner.

Comprehensive services complete our offering: SICK LifeTime Services provide support throughout the machine life cycle and ensure safety and productivity.

For us, that is “Sensor Intelligence.”

WORLDWIDE PRESENCE:

Contacts and other locations –www.sick.com