

Safety door interlocks

TZM/TZF type series

Spring-operated versions

with manual release

Features

- Interlocking device to EN 1088 with failsafe device
- Funnel-shaped entry for actuator, suitable for large door tolerances
- Manual release with 3-square socket key
- Holding force 1,500 N
- Operating head adjustable 3 x 90°
- Closed circuit-current principle (unlocked under voltage)

Cross-references

- General description: refer to page 3
- Contact configuration: see below
- Actuator: refer to page 54
- Accessories: refer to page 58
- Assembly instructions: refer to page 68
- Technical data: refer to page 69

Options (on request)

- Plug connection
- Version with Viton seals for use with particularly aggressive media
- Individually coded actuator
- Other voltages



N.B.

Actuator: standard actuator TZ/CO supplied. Refer to page 54 for dimensions and other actuators.



LED display: In the case of devices with LED display the NC contacts are not floating. Only sequencing circuitry may be used in which the two channels are controlled with positive opening.

Manual release: for the manual release with 3-square socket key for maintenance, setting up, power failure etc.

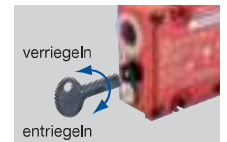

Contact configurations

TZFS..

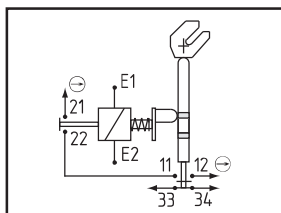

TZFWs...

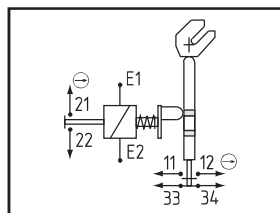

TZFCs...

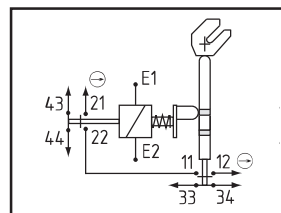

TZFCWS

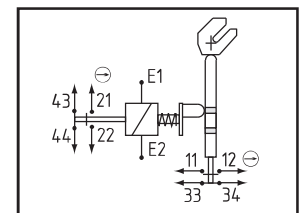

TZFWs.2MOE

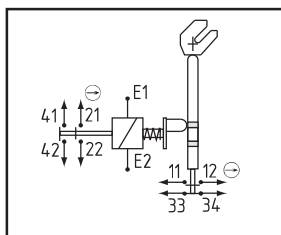

TZFWs 3Ö

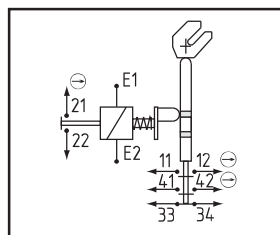

TZFWs 4Ö

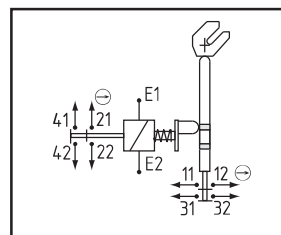

TZFSL..

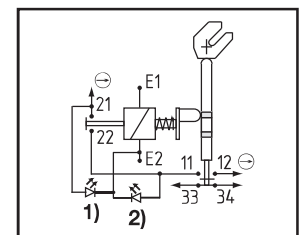

Representations of the contacts with unlocked solenoid and open guard.
LED display: 1) green "locked", 2) yellow "door closed"

Test symbol (with respect to the basic design)

BIA 954023

A031156

Scope of delivery

Door interlock, standard actuator, fixing material, disposable screws, standard 3-square socket key (refer to page 58 for further information)

Product table

Type	Version	Supply voltage	Part number
2 NC in series ...			
TZFS	... + 1 NO	24 VDC	191 5040
TZFS115	... + 1 NO	115 VAC	191 5140
TZFS230	... + 1 NO	230 VAC	191 5340
TZFSL	... + 1 NO, with LED display	24 VDC	191 5045
2 NC parallel ...			
TZFCS	... + 2 NO	24 VDC	191 5102
TZFCS115	... + 2 NO	115 VAC	191 5115
TZFCS230	... + 2 NO	230 VAC	191 5116
3 NC parallel			
TZFWS	... + 1 NO	24 VDC	191 5095
TZFWS115	... + 1 NO	115 VAC	191 5096
TZFWS230	... + 1 NO	230 VAC	191 5097
TZFCWS	... + 2 NO	24 VDC	191 5112
4 NC parallel			
TZFWS.2MOE	... + 1 NO	24 VDC	191 8954
TZFWS 3Ö	... + 1 NO	24 VDC	191 8950
TZFWS 4Ö	... + 1 NO	24 VDC	191 8951

Dimensions TZF ...S

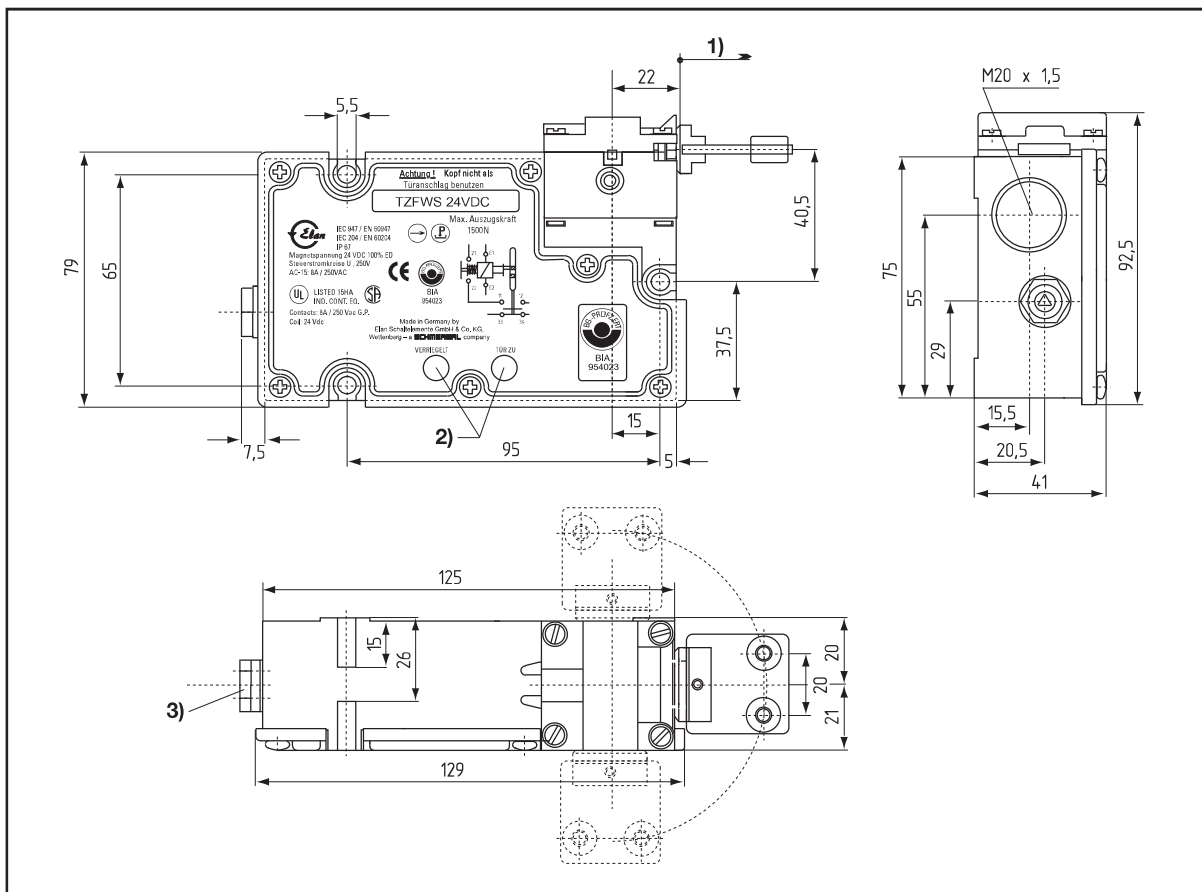

- 1) Dimensional base for actuator
- 2) LED display optional
- 3) Manual release