



# DGS25-16R00600

DGS25

PRODUCT PORTFOLIO

**SICK**  
Sensor Intelligence.

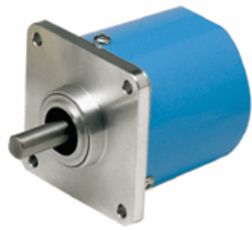

Illustration may differ



### Ordering information

Model name	Part no.
DGS25-16R00600	7101404

Other models and accessories → [www.sick.de/DGS25](http://www.sick.de/DGS25)

### Detailed technical data

#### Technical specifications

Shaft / Flange design	Solid shaft, servo flange
Shaft diameter	3/8"
Number of lines	600
Interface	5 V, TTL
Connection type	Cable, axial, 1.5 m
Moment of inertia of the rotor	16.9 gcm <sup>2</sup>
Measuring step	90°/number of lines
Reference signal, number	1
Reference signal, position	Gated 180° nominal
Measuring step deviation	45/Z °
Maximum output frequency	≤ 200 kHz
Max. angular acceleration	5 x 10 <sup>5</sup> rad/s <sup>2</sup>
Start up torque with shaft seal	3.5 Ncm
Start up torque without shaft seal	1.1 Ncm
Permissible shaft loading, axial	178 N
Permissible shaft loading, radial	155 N
Working temperature range	0 °C ... +70 °C
Storage temperature range	-20 °C ... +85 °C
Permissible relative humidity	90%
Resistance to shocks	50/11 g/ms
Resistance to vibration	5/2000 @ 20 g
Protection class according to IEC 60529:	IP 66
Supply voltage	DC, 4.75 V, 5.25 V

Dimensional drawing (Dimensions in mm (inch))

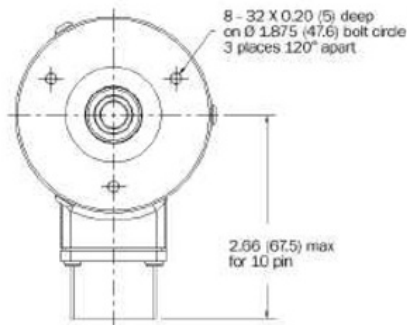
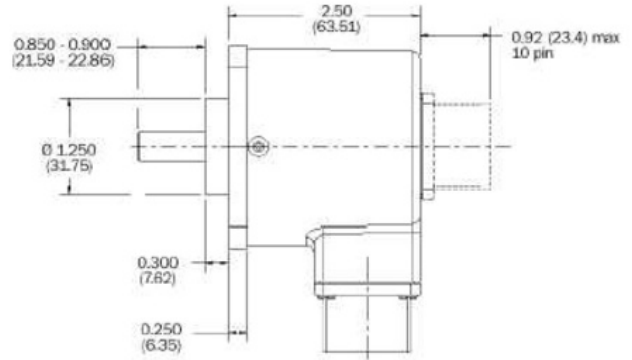

**Australia**

Phone +61 3 9457 0600  
1800 33 48 02 - tollfree  
E-Mail sales@sick.com.au

**Belgium/Luxembourg**

Phone +32 (0)2 466 55 66  
E-Mail info@sick.be

**Brasil**

Phone +55 11 3215-4900  
E-Mail marketing@sick.com.br

**Canada**

Phone +1 905 771 14 44  
E-Mail information@sick.com

**Česká republika**

Phone +420 2 57 91 18 50  
E-Mail sick@sick.cz

**China**

Phone +86 4000 121 000  
E-Mail info.china@sick.net.cn  
Phone +852-2153 6300  
E-Mail ghk@sick.com.hk

**Danmark**

Phone +45 45 82 64 00  
E-Mail sick@sick.dk

**Deutschland**

Phone +49 211 5301-301  
E-Mail info@sick.de

**España**

Phone +34 93 480 31 00  
E-Mail info@sick.es

**France**

Phone +33 1 64 62 35 00  
E-Mail info@sick.fr

**Great Britain**

Phone +44 (0)1727 831121  
E-Mail info@sick.co.uk

**India**

Phone +91-22-4033 8333  
E-Mail info@sick-india.com

**Israel**

Phone +972-4-6801000  
E-Mail info@sick-sensors.com

**Italia**

Phone +39 02 27 43 41  
E-Mail info@sick.it

**Japan**

Phone +81 (0)3 5309 2112  
E-Mail support@sick.jp

**Magyarország**

Phone +36 1 371 2680  
E-Mail office@sick.hu

**Nederland**

Phone +31 (0)30 229 25 44  
E-Mail info@sick.nl

**Norge**

Phone +47 67 81 50 00  
E-Mail sick@sick.no

**Österreich**

Phone +43 (0)22 36 62 28 8-0  
E-Mail office@sick.at

**Polska**

Phone +48 22 837 40 50  
E-Mail info@sick.pl

**România**

Phone +40 356 171 120  
E-Mail office@sick.ro

**Russia**

Phone +7-495-775-05-30  
E-Mail info@sick.ru

**Schweiz**

Phone +41 41 619 29 39  
E-Mail contact@sick.ch

**Singapore**

Phone +65 6744 3732  
E-Mail sales.gsg@sick.com

**Slovenija**

Phone +386 (0)1-47 69 990  
E-Mail office@sick.si

**South Africa**

Phone +27 11 472 3733  
E-Mail info@sickautomation.co.za

**South Korea**

Phone +82 2 786 6321/4  
E-Mail info@sickkorea.net

**Suomi**

Phone +358-9-25 15 800  
E-Mail sick@sick.fi

**Sverige**

Phone +46 10 110 10 00  
E-Mail info@sick.se

**Taiwan**

Phone +886-2-2375-6288  
E-Mail sales@sick.com.tw

**Türkiye**

Phone +90 (216) 528 50 00  
E-Mail info@sick.com.tr

**United Arab Emirates**

Phone +971 (0) 4 8865 878  
E-Mail info@sick.ae

**USA/México**

Phone +1(952) 941-6780  
1 800-325-7425 - tollfree  
E-Mail info@sickusa.com

More representatives and agencies  
at [www.sick.com](http://www.sick.com)