



ISD260-1121

ISD260

PRODUCT PORTFOLIO

SICK
Sensor Intelligence.



Ordering information

Type	Part no.
ISD260-1121	1017381

Other models and accessories → www.sick.com/ISD260



Detailed technical data

Performance

Transmission range	0.2 m ... 180 m
Light source	Infrared LED (860 nm)
Typ. light spot size (distance)	1.4 m (at 100 m)
Aperture angle	Ca. ± 0.4°
Heating	✓

Interfaces

Data transmission rate	0.5 MBaud
Switching output	UV - 2 V: fault-free operation, I _{out} = 20 mA
Data interface	RS-422/-485 PROFIBUS DP
Switching input	V _s : sender deactivated
Signal delay	≤ 2 μs

Mechanics/electronics

Supply voltage V_s	DC24 V, +20% / -5% (with heating) DC24 V, ±20% (without heating)
Housing material	Metal
Connection type	Connector, Sub-D, 9-pin
Weight	1 kg
Current consumption	Without heating ≤ 0.4 A With heating ≤ 2.5 A
Enclosure rating	IP 54
Protection class	III

Ambient data

Electromagnetic compatibility (EMC)	EN 61000-6-2 / EN 61000-6-4
Ambient temperature	Operation without heating: 0 °C ... +55 °C Operation with heating: -38 °C ... +55 °C Storage: -20 °C ... +70 °C
Max. rel. humidity (not condensing)	± 90 %, Non-condensing

Classifications

ECI@ss 5.0	19039001
ECI@ss 5.1.4	19039001
ECI@ss 6.0	19179090
ECI@ss 6.2	19179090
ECI@ss 7.0	19179090
ECI@ss 8.0	19179090
ECI@ss 8.1	19179090
ECI@ss 9.0	19179090
ETIM 5.0	EC000515
ETIM 6.0	EC000515
UNSPSC 16.0901	43201404

Dimensional drawing (Dimensions in mm (inch))

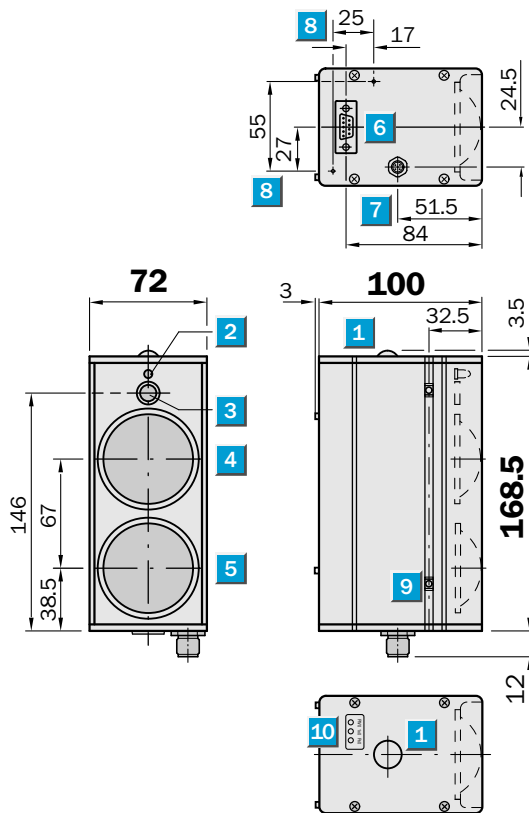

- ① View of optical adjustment aid (cross-line)
- ② LED function indicator "interrupted light beam"
- ③ Light inlet for optical adjustment aid
- ④ Receiver lens
- ⑤ Sender lens
- ⑥ 9-pin D-sub female connector (data interface)
- ⑦ 5-pin M12 round connector (power supply and function interfaces)
- ⑧ M3 threaded mounting hole - 5 mm deep, for plug cover
- ⑨ M5 running nut (in groove), max. screwing depth 10 mm from housing surface
- ⑩ LED function indicators "Power on", "RxD", and "TxD"

Connection type

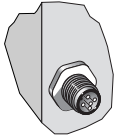
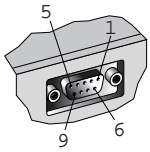

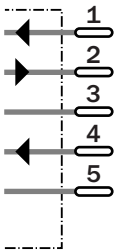
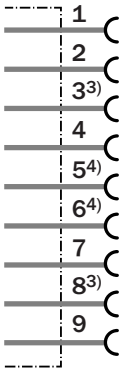

Connection diagram



Recommended accessories

Other models and accessories → www.sick.com/ISD260

	Brief description	Type	Part no.
Device protection (mechanical)			
	Water protection	Cover for male connector	2016130
Terminal and alignment brackets			
	Alignment unit, steel, zinc coated, mounting hardware included	Three-point mounting	5306369
Plug connectors and cables			

	Brief description	Type	Part no.
	Head A: cable Head B: cable Cable: shielded For RS-485 network	Data cable by the meter	6007508
	Head A: connection inlay (male connector), D-Sub-HD, 9-pin, 15-pin Cable: unshielded	D-Sub male con- nector housing	6009438
	Head A: connection inlay (male connector), D-Sub, 9-pin Head B: - Cable: unshielded	D-Sub plug con- nector insert	6007336

SICK AT A GLANCE

SICK is one of the leading manufacturers of intelligent sensors and sensor solutions for industrial applications. A unique range of products and services creates the perfect basis for controlling processes securely and efficiently, protecting individuals from accidents and preventing damage to the environment.

We have extensive experience in a wide range of industries and understand their processes and requirements. With intelligent sensors, we can deliver exactly what our customers need. In application centers in Europe, Asia and North America, system solutions are tested and optimized in accordance with customer specifications. All this makes us a reliable supplier and development partner.

Comprehensive services complete our offering: SICK LifeTime Services provide support throughout the machine life cycle and ensure safety and productivity.

For us, that is “Sensor Intelligence.”

WORLDWIDE PRESENCE:

Contacts and other locations –www.sick.com