





## A glimpse of the category and code for domestic and foreign commonly utilized limit switch's actuating head

Code	Actuating head type	Plunger type	Plunger type with roller	Rotating arm type with roller	Rotating arm with adjustable roller	Free-diversions type	Adjustable metal oscillating block type	Fork type (double roller) 21、22、21S、22S
Travel switch model								
YBLX-ME8000		8111	8112、8122	8104	8108	8166、8169、8101	8107	
YBLX-WL		D、D1D、AD、SD、D1SD、ASD	AD2、01D2、WL-D2	CA2、01CA2、ACA2	CA12、ACA12、01CA12-2N	NJ、01NJ、ANJ	CL、ACL、HAL	CA32、01CA32、ACA32
YBLX-WLF5		D	D2、D28	H2	H12	NJ	HL	
YBLX-HI/5000		5100	5200	5000	5030	5300A、5500	5050	
YBLX-CK/S		S101	S102	S131、S139	S141		S159	
YBLX-CK/M		M110	M102、M121	M115		M106		
YBLX-CK/J		J161	J167	J10511	J10541		J10559	
YBLX-CK/P		P110	P102、P121、P128、P127	P118	P145	P106	P155	
YBLX-CK/T		T110	T102、T121	T118				
YBLX-P1		B、C	D、E、F	G、H、J、K	N、U	R	P、Q、V、W	
YBLX-K3		20S/Z、21S/Z	20S/L、21S/L	20S/B、21S/B	20S/T、21S/T	20S/W	20S/J	20S/H1、H2、H3
YBLX-K1		311、311M	411、411M	111、111M		511、511M		211、211M
YBLX-19		001		111、121、131				212、222、232
YBLX-2				111、121、131				212、222、232
YBLX-4				11、12、11S、12S		511		21、22、21S、22S
YBLX-K2		001、311	101、411	M111、131				211、222

## Limit switch operating performances symbol and definitions

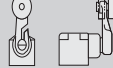
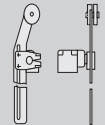
Operating force (OF)	Force made on actuating head to activate switch contact
Reset force (RF)	Force made on actuating head to make contact back to normal position
Travel force (TF)	Force made to make actuating head move from free position to the limit.
Free position (FP)	Actuating head's initial position without external force applied
Operating position (OP)	Actuating head's position when contact rapidly moves to action contacting position
Reset position (RP)	Actuating head's position when contact rapidly moves back to normal position from action contacting position
Total travel position (TTP)	Actuating head's position at threshold
Passage travel (PT)	Distance or angle passed by actuating head from free position to stop position
Over travel (OT)	Distance or angle passed by actuating head beyond the action position
Margin distance (MD)	Distance or angle from action position to reset position
Total travel (TT)	Total distance or total angle of actuating head's action travel

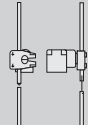
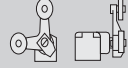
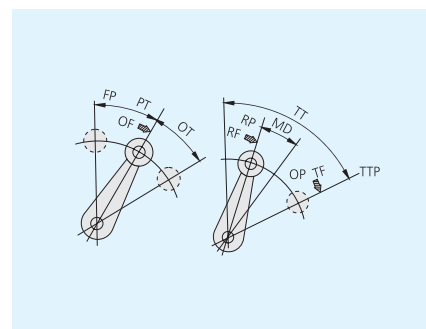
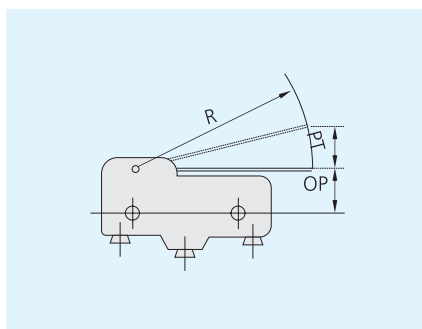
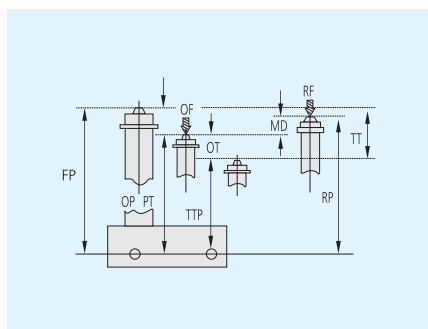



## YBLX-ME8000 Travel Switch

Contacting types

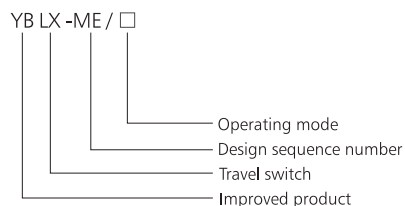
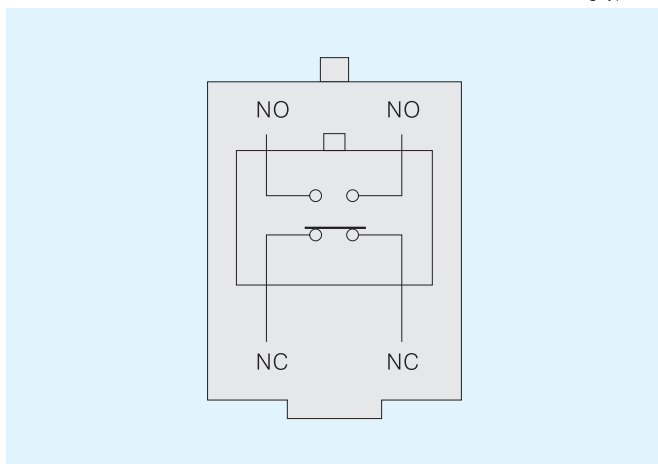

Protection level	IP52	
Operating frequency (operations / minute)	Mechanical	120
	Electric	30
Mechanical life(operations)	$60 \times 10^4$	
Electrical life(operations)	$30 \times 10^4$	
Insulation resistance	$\geq 5M \Omega$ (DC500V)	
Contact resistance	$\leq 200m \Omega$ (initial value)	
Environmental temperature	$-15^{\circ}C \sim +60^{\circ}C$	
Relative humidity	$\leq 95\%$	
Voltage withstand	Between terminals of the same polarity (1140V)	
	Between electrified components and earth (2500V)	
	Between terminals and un-electrified metal components (2500V)	
Rated voltage(V)	AC 380V DC220V	
Rated current	AC0.8A DC0.16A	

Model (Recommended)	Operating mode	Substituted model (production stopped)		
YBLX-ME/8104	Rotating arm with roller	YBLX-AZ/8104	YBLX-TZ/8104	
YBLX-ME/8107	Adjustable rotating lever	YBLX-AZ/8107	YBLX-TZ/8107	
YBLX-ME/8108	Adjustable rolling pivoted arm	YBLX-AZ/8108	YBLX-TZ/8108	
YBLX-ME/8111	Vertical compression plunger type	YBLX-AZ/8111	YBLX-TZ/8111	
YBLX-ME/8112	Vertical compression plunger type with horizontal roller	YBLX-AZ/8112	YBLX-TZ/8112	

Model (Recommended)	Operating mode	Substituted model (production stopped)		
YBLX-ME/8122	Vertical compression plunger type with roller which at right awgles to the fix board	YBLX-AZ/8122	YBLX-TZ/8122	
YBLX-ME/8166	Free-directions type I	YBLX-AZ/8166	YBLX-TZ/8166	
YBLX-ME/8169	Free-directions type II	YBLX-AZ/8169	YBLX-TZ/8169	
YBLX-ME/8101	Free-directions type III	YBLX-AZ/8101 YBLX-AZ/9101	YBLX-TZ/8101 YBLX-TZ/8101	YBLX-ME/9101

Model	Operating mode	OF(max)	RF(min)	PT(max)	OT(min)	MD(max)	TT
YBLX-ME/8104	Rotating arm with roller	12N	0.5N	35°	70°	10°	110°
YBLX-ME/8107	Adjustable rotating lever	12N	0.2-.5N	35°	70°	10°	110°
YBLX-ME/8108	Adjustable rotating arm with roller	12N	1.5N	35°	70°	10°	110°
YBLX-ME/8111	Vertical compression plunger type	12N	0.1-5N	5mm	2mm	0.7mm	7mm
YBLX-ME/8112	Vertical compression plunger type with horizontal roller	15N	1-5N	5mm	2mm	0.7mm	7mm
YBLX-ME/8122	Vertical compression plunger type with roller which at right awgles to the fix board	15N	1.5N	5mm	2mm	0.7mm	7mm
BLX-ME/8166	Free-directions type I	12N	-N	35°	-	-	-
YBLX-ME/8169	Free-directions type II	12N	-N	35°	-	-	-
YBLX-ME/8101	Free-directions type III	12N	-N	35°	-	-	-

YBLX-ME/8104

YBLX-ME/8108

