



LMS211-30206

LMS2xx

2D LASER SCANNERS

SICK
Sensor Intelligence.



Ordering information

Type	Part no.
LMS211-30206	1018023

Other models and accessories → www.sick.com/LMS2xx



Detailed technical data

Features

Version	Mid Range
Field of application	Outdoor
Light source	Infrared (905 nm)
MTBF	50,000 h
Laser class	1, eye-safe (EN/IEC 60825-1, 21CFR 1040.10)
Aperture angle	100°
Scanning frequency	75 Hz
Angular resolution	0.25° 0.5° 1°
Heating	Yes, including additional front window heating
Operating range	0 m ... 80 m
Max. range with 10 % reflectivity	30 m
Fog correction	Yes

Performance

Response time	≥ 13 ms
Detectable object shape	Almost any
Systematic error	± 35 mm ¹⁾
Statistical error	± 10 mm ¹⁾
Integrated application	Field evaluation
Number of field sets	2 field triples (6 fields)
Simultaneous evaluation cases	1 (3 fields)

¹⁾ Typical value; actual value depends on environmental conditions.

Interfaces

Serial (RS-232, RS-422)	✓
Function	Host, AUX
Data transmission rate	RS-232: 9.6 / 19.2 kBd and RS-422: 9.6 / 19.2/ 38.4/ 500 kBd
Switching inputs	1

Switching outputs	3
Optical indicators	0

Mechanics/electronics

Electrical connection	1 x 16-pin plug
Operating voltage	≤ 24 V DC
Power consumption	30 W, + 140 W heating
Housing	Aluminum die-cast base plate Covering PU
Housing color	Gray (RAL 7032)
Enclosure rating	IP 67
Protection class	II (VDE 0106/IEC 1010-1) ¹⁾
Weight	9 kg
Dimensions (L x W x H)	248 mm x 351 mm x 265 mm

¹⁾ Insulated.

Ambient data

Object remission	1.8 % ... 10,000 %
Electromagnetic compatibility (EMC)	EN 61000-6-2 / EN 61000-6-3 / A11 (2004-07)
Vibration resistance	IEC 68
Shock resistance	IEC 68
Ambient operating temperature	-30 °C ... +50 °C
Storage temperature	-30 °C ... +70 °C

General notes

Life cycle phase	Discontinued
Note on use	Not suitable for personnel protection

Classifications

ECl@ss 5.0	27270990
ECl@ss 5.1.4	27270990
ECl@ss 6.0	27270913
ECl@ss 6.2	27270913
ECl@ss 7.0	27270913
ECl@ss 8.0	27270913
ECl@ss 8.1	27270913
ECl@ss 9.0	27270913
ETIM 5.0	EC002550
ETIM 6.0	EC002550
UNSPSC 16.0901	46171620

Dimensional drawing (Dimensions in mm (inch))

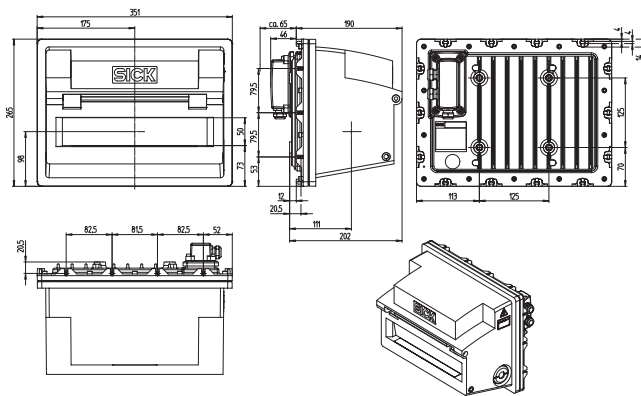

Operating range diagram

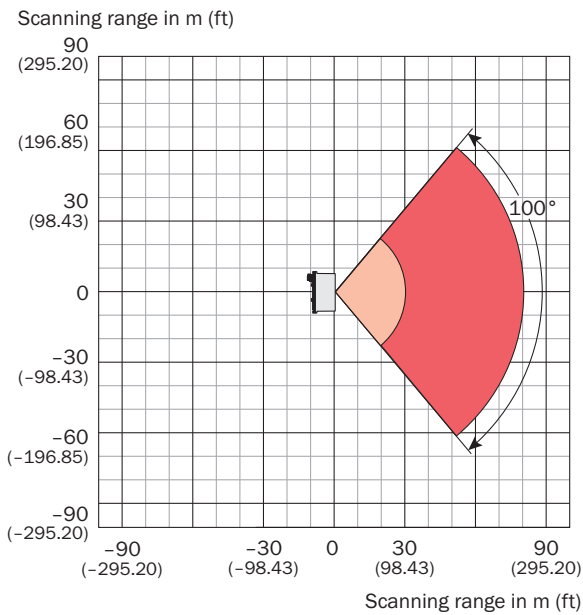





- Scanning range max. 80 m (262.47 ft)
- Scanning range for objects up to 10 % remission 30 m (98.43 ft)

Recommended accessories

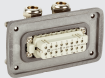
Other models and accessories → www.sick.com/LMS2xx

	Brief description	Type	Part no.
Device protection (mechanical)			
	Dust prevention shield, gray	Weather hood	2025793

	Brief description	Type	Part no.
Mounting brackets and mounting plates			
	Mounting kit for wall-mounting (adjustment bracket), steel, zinc coated	Mounting kit	2018303
Plug connectors and cables			
	Head A: female connector, 16-pin Head B: - Cable: unshielded	16-pin female connector	2018301
	Head A: 16-pin Head B: - Cable: unshielded For connection plug of the laser scanner	16-pin plug insert (female connector)	6004379
	Cable: RS-232, RS-422, unshielded, 5 m, configuration cable pre-assembled for RS-232, for the connection of PCs/power supply	Service cable	2019561
Reflectors			
	Reflective tape	Reflective tape	4029444
Test and monitoring tools			
	Scan finder, receiver to localize infrared scans	Scan-Finder LS-80L	6020756

SICK AT A GLANCE

SICK is one of the leading manufacturers of intelligent sensors and sensor solutions for industrial applications. A unique range of products and services creates the perfect basis for controlling processes securely and efficiently, protecting individuals from accidents and preventing damage to the environment.

We have extensive experience in a wide range of industries and understand their processes and requirements. With intelligent sensors, we can deliver exactly what our customers need. In application centers in Europe, Asia and North America, system solutions are tested and optimized in accordance with customer specifications. All this makes us a reliable supplier and development partner.

Comprehensive services complete our offering: SICK LifeTime Services provide support throughout the machine life cycle and ensure safety and productivity.

For us, that is “Sensor Intelligence.”

WORLDWIDE PRESENCE:

Contacts and other locations –www.sick.com