

0239392



BI 9028 up to 7.5 kW



BI 9028 bis 15 kW

Your Advantages

- Softstart and brake in one unit
- Easy wiring
- Space saving

Features

- According to IEC/EN 60947-4-2
- 2-phase motor control
- For motors up to 15 kW at 3 AC 400 V
- Separate settings for start and brake time, as well as starting and braking torque
- Galvanic isolation of control input with wide voltage range up to AC/DC 230 V
- No external motor or braking contactor necessary
- 3 auxiliary voltages up to 230 V
- Monitors undervoltage and phase sequence
- 2 relay outputs for indication of status and fault
- LED-indication
- As option with voltfree contacts for start and stop
- As option with input to detect motor temperature
- BI 9028 up to 7.5 kW: 67.5 mm width
- BI 9028 up to 15 kW: 90 mm width

Approvals and Markings



Applications

- Motor with gear, belt or chain drive
- Fans, pumps, conveyor systems, compressors
- Woodworking machines, centrifuges
- Packing machines, door-drives

Block Diagrams

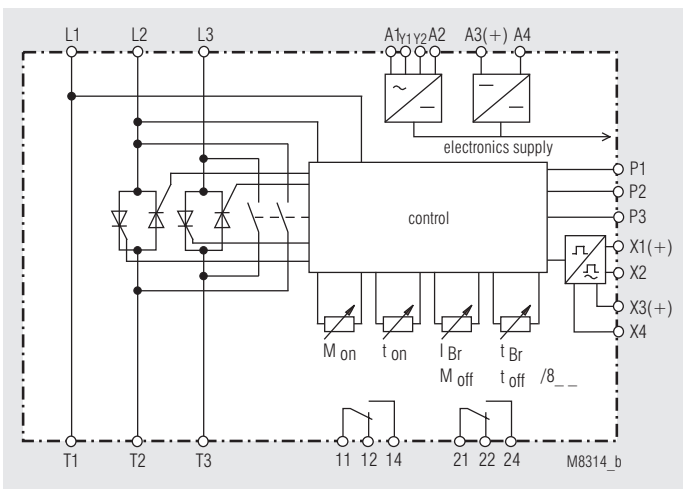

BI 9028 up to 15 kW

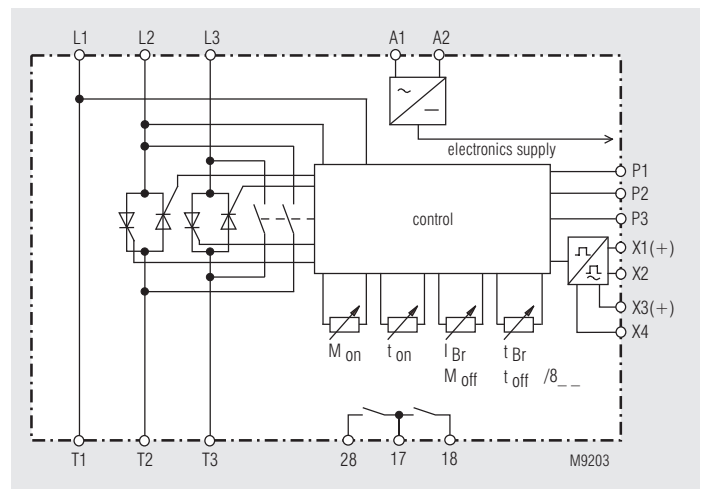

BI 9028 up to 15 kW, $U_H = AC 400 V$

Circuit Diagrams

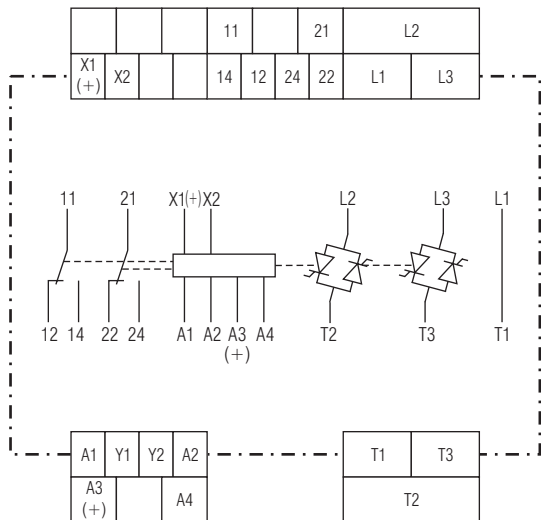

BI 9028.38

M8263_b

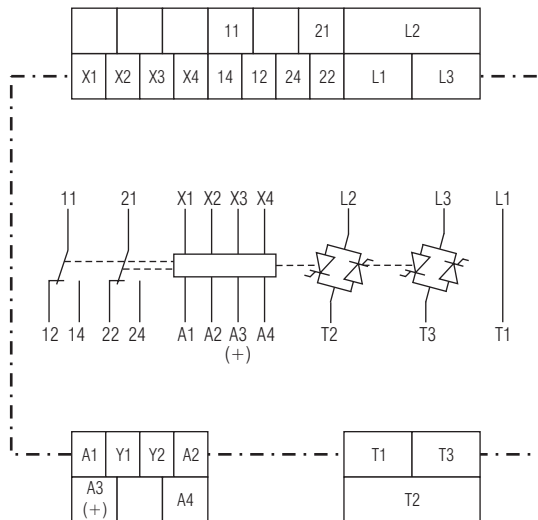

BI 9028.38/001

M8264_c

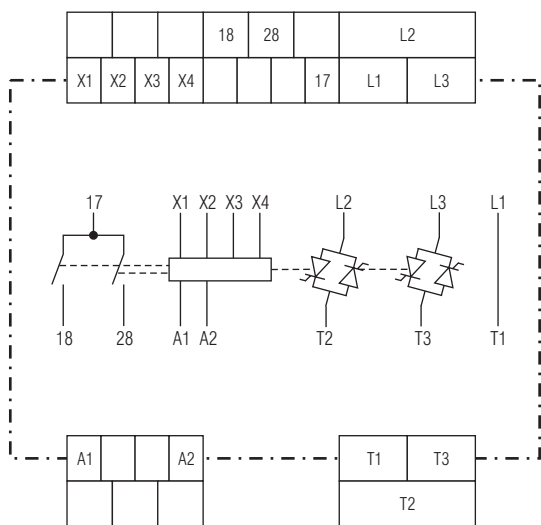

BI 9028.38/001, UH = AC 400 V

M8799

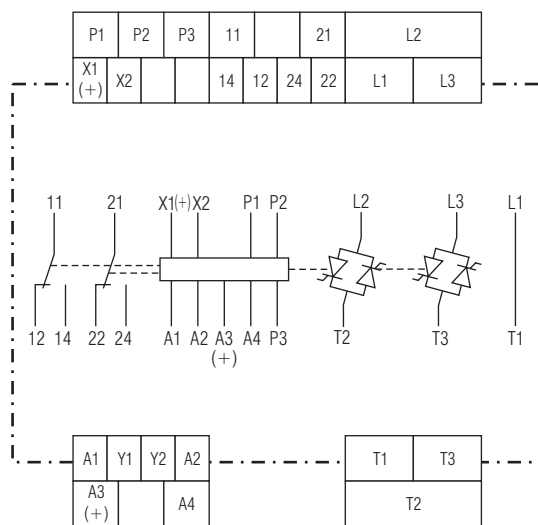

BI 9028.38/010

M8338_a

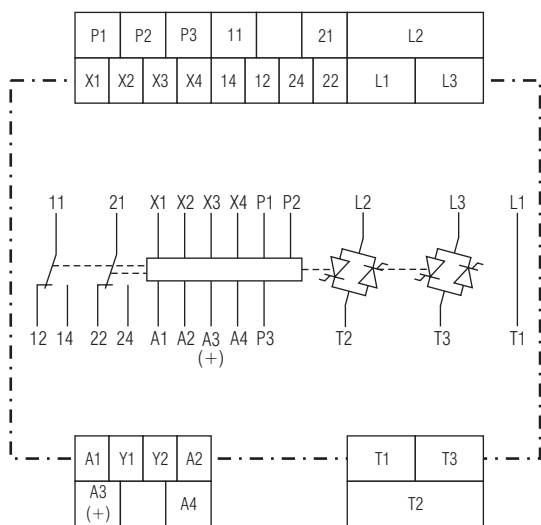

BI 9028.38/011

M8344_b

Connection Terminal	
Terminal designation	Signal description
X1, X2, X3, X4	Start-, Stopp signal
P1, P2, P3	Thermistor
11, 12, 14	Indicator relay Motor on
21, 22, 24	Indicator relay device ready
A1, A2	Auxiliary voltage main
A3(+), A4	Auxiliary voltage DC 24 V
Y1, Y2	Switching 115 V / 230 V
L1	Phase voltage L1
L2	Phase voltage L2
L3	Phase voltage L3
T1	Motor connection T1
T2	Motor connection T2
T3	Motor connection T3

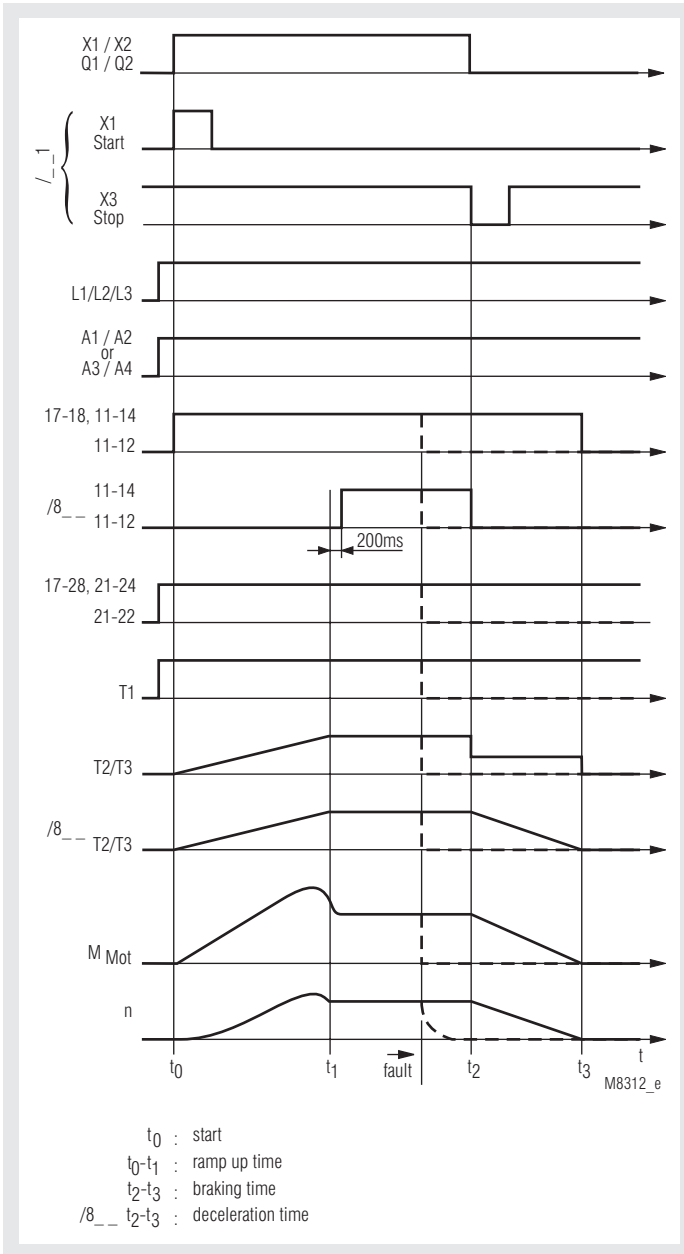

BI 9028.38/_1_1

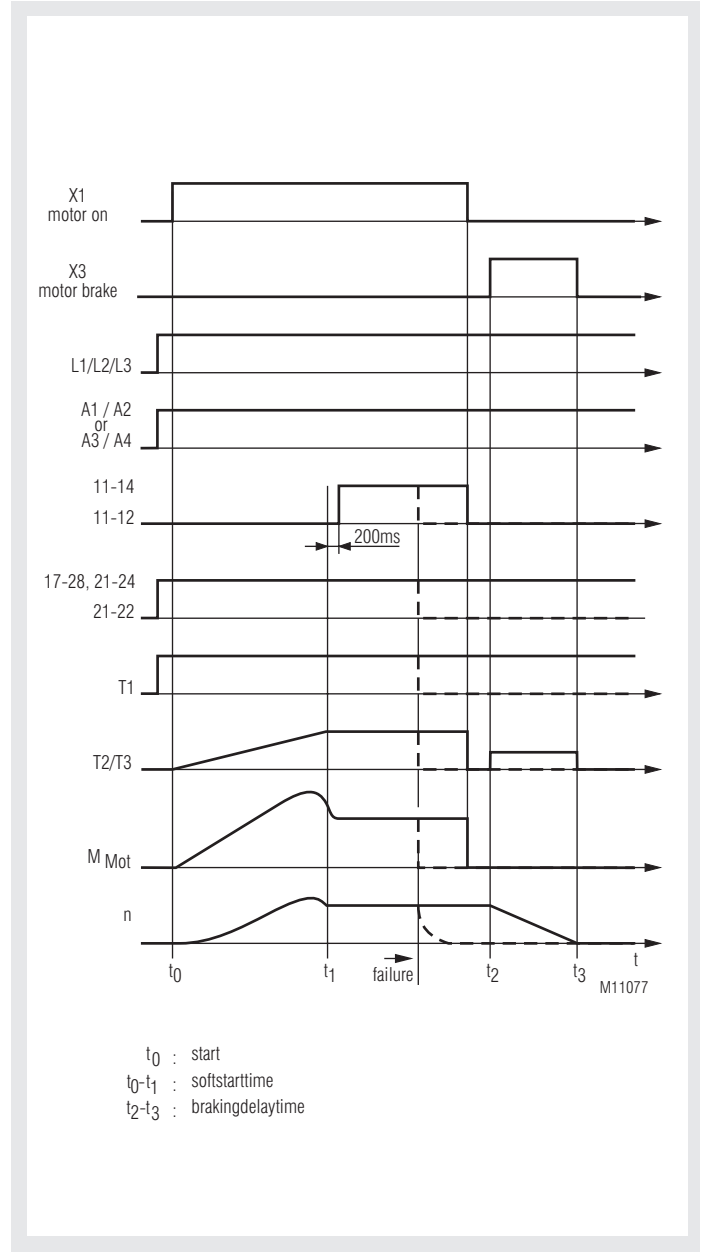

BI 9028.38/5_

Function

Softstarters are electronic devices designed to enable 1-phase or 3-phase induction motors to start smoothly. The devices slowly ramps up the current on two phases, therefore allowing the motor torque to build up slowly. This reduces the mechanical stress on the machine and prevents damage to conveyed material.

These features allow cost saving constructions of mechanical gear. External motor or brake contactors are not necessary.

Start/Stop switch

When the motor is on full speed after the starting with start/stop switch S the semiconductors are bridged with internal relay contacts to prevent internal power losses and heat built up.

When stopping the motor via start/stop switch S braking is started. The braking current flows for the adjusted time through the motor windings.

On variant /_ _ 1 the start and stop function is realised via bush buttons.

On variant /5_ _ the softstart and brake function are separate switching via control input X1, X3.

Monitoring relay 1 (contact 11-12-14 / 17-18)

The relay energises with the start command and de-energises after finish of braking. When a fault occurs the relay de-energises when the semiconductors switch off. The monitoring relay 1 can be used to activate a mechanical holding brake. With the variant BI 9028/8_ _ and BI 9028/5_ _ the relay switches when the semiconductors are bridged.

Monitoring relay 2 (contact 21-22-24 / 17-28)

This relay energises as soon as the unit is ready for operation after connecting it to power. On internal overtemperature, phase failure, wrong phase sequence and overtemperature on the motor (variant BI 9028/_ 1_) the relay 2 de-energises. The power semiconductors are switched off. The internal temperature monitoring protects the thyristors. The temperature monitoring of the motor (variant BI 9028/_ 1_) has an input for a bimetallic contact or PTCs. The fault is reset by disconnecting the power supply temporarily after the temperature is down again.

Phase failure and phase sequence monitoring protect motor and plant. The fault is reset by disconnecting the power supply temporarily.

Input P₁ / P₂ / P₃ to monitor the motor temperature on variant BI 9028/ _ 1_

To monitor overtemperature on the motor a bimetallic contact can be connected to P₂ / P₃. When overtemperature is detected the motor switch off and relay 2 de-energises.

On P₁ / P₂ up to 6 PTC sensors can be connected. On detection of overtemperature, short circuit or broken wire (in sensor circuit) the motor also switch off and relay 1 + 2 de-energize.

The fault is reset by disconnecting the power supply temporarily after the temperature on the motor is down again. After every reset the unit has to be started again via control input or start/stop button.

Indication

Green LED: Continuous light: When auxiliary supply connected
Flashing light: While starting and braking

Monitoring relay 1

Yellow LED: Continuous light: When contact 11-12-14 / 17-18 switched on

Monitoring relay 2

Yellow LED: Continuous light: When contact 21-22-24 / 17-28 switched on
Flashing light: When contact 21-22-24 / 17-28 switched off

1*): Overtemperature on thyristor (internal)
2*): Overtemperature on motor or broken wire in sensor circuit P₁/P₂, only at variant /01_ _
3*): Short circuit on sensor circuit P₁/P₂, only at variant /01_ _
4*): Phase failure
5*): Incorrect phase sequence, exchange connections on L1 and L2
6*): Incorrect frequency
7*): Heat sink temperature sensor defective
8*): Braking time exceeded

1-8*) = Number of flashing pulses in short sequence

Notes

Variation of speed is not possible with this device. Without load a softstart cannot be achieved. It is recommended that the softstart is protected by superfast semiconductor fuses rated as per the current rating of the softstart or motor. However, standard line and motor protection is acceptable, but for high starting frequencies motor winding temperature monitoring is recommended. The softstarter must not be operated with capacitive load e.g. power factor compensation on the output.

The current in the 3 phases is different due to 2-phase control. To avoid false tripping of the motor overload it is recommended to select a suitable overload for this application.

In respect to safety of persons and plant only qualified staff is allowed to work on this device.

Technical Data

Phase / motor

voltage L1/L2/L3

with auxiliary voltage: 3 AC 200 V -10 % ... 480V + 10 %

without auxiliary voltage: 3 AC 200 V ± 10 %

Nominal frequency: 50 / 60 Hz

	Width		
	67.5 mm	90 mm	90 mm
Nominal motor power P _N at 400 V:	7.5 kW	11 kW	15 kW
Switching frequency at 3 x I _N , 5 s, v _U = 20°C:	10 / h	45 / h	30 / h
permissible braking current	35 A	50 A	65 A

Min. motor power: Approx. 0.1 P_N

Start torque: 20 ... 80 %

Ramp time: 1 ... 20 s

Braking time: 1 ... 20 s

Braking delay: 0.5 s

Deceleration torque

BI 9028/8_ _: 20 ... 80 %

Deceleration time

BI 9028/8_ _: 1 ... 20 s

Recovery time: 200 ms

Auxiliary voltage:

Model AC 115/230 V:

A1/A2, AC 115 V, +10%, -15%: Bridge A1 - Y1

bridge A2 - Y2

A1/A2, AC 230 V, +10%, -15%: Bridge Y1 - Y2

A3(+)/A4, DC 24 V, +10%, -15%: Polarity protected

Model AC 400 V:

A1/A2, AC 400 V, +10%, -15%: No bridge

Power consumption: 3 W

Residual ripple max.: 5 %

Short circuit strength

7.5 kW

Line protection: Assignment type 1 acc. to IEC 60947-4-1 max 50 A Typ gG

Semiconductor fuse: Assignment type 2 acc. to IEC 60947-4-1 max. 1800 A² s

11 kW

Line protection: Assignment type 1 acc. to IEC 60947-4-1 max 63 A Typ gG

Semiconductor fuse: Assignment type 2 acc. to IEC 60947-4-1 max. 6600 A² s

15 kW

Line protection: Assignment type 1 acc. to IEC 60947-4-1 max. 80 A Typ gG

Semiconductor fuse: Assignment type 2 acc. to IEC 60947-4-1 max. 6600 A² s

Inputs

Control input X1/X2

voltage: AC/DC 24 - 230 V

Softstart when: > 20 V

Braking when: < 5 V

BI 9028/0_ 1:

Control input X1/X4, X3/X4: Volt free contact

alternative

Control input X1/X2, X3/X2

Voltage: AC/DC 24 V

Softstart when: > 15 V

Braking when: < 5 V

Control input Q1/Q2: Volt free contact

Switching current: DC 10 mA

Technical Data	
Switching voltage:	DC 24 V
Input P₂ / P₃ for bimetallic contact	
Current:	Approx. 1 mA (= switch closed)
Voltage:	Approx. 5 V (= switch open)
Input P₁ / P₂ for PTC-sensor	
Temperature sensor:	According to DIN 44081/082
Number of sensors:	1 ... 6 in series
Response value:	3.2 ... 3.8 kΩ
Reset value:	1.5 ... 1.8 kΩ
Load in measuring circuit:	< 5 mW (at R = 1.5 kΩ)
Broken wire detection:	> 3.1 kΩ
Measuring voltage:	≤ 2 V (at R = 1.5 kΩ)
Measuring current:	≤ 1 mA (at R = 1.5 kΩ)
Voltage, when broken wire in sensor circuit:	DC approx. 5 V
Current, when short circuit in sensor circuit:	DC approx. 0.5 mA

Monitoring Output

Contacts		
BI 9028.38:	2 x 1 changeover contacts	
BI 90.28.38 (U _H = AC 400 V):	2 x 1 NO contacts	
Thermal continuous current I_{th}:	4 A	
Switching capacity		
to AC 15		
NO contact:	3 A / 230 V	IEC/EN 60947-5-1
NC contact:	1 A / 230 V	IEC/EN 60947-5-1
Electrical life:		
to AC 15 at 3 A, AC 230 V:		
	1 x 10 ⁵ switching cycles	
Short circuit strength		
max. fuse rating:	4 A gG /gL	IEC/EN 60947-5-1
Mechanical life:	1 x 10 ⁸ switching cycles	

General Data

Operating mode:	Continuous operation	
Temperature range		
Operation:	0 ... + 45 °C	
Storage:	- 25 ... + 75 °C	
Relative air humidity:	max. 95 %	
Altitude:	< 1000 m	
Clearance and creepage distances		
rated impulse voltage / pollution degree between		
Motor voltage, heat sink:	6 kV / 2	IEC/EN 60664-1
Control voltage to auxiliary voltage, motor voltage:	4 kV / 2	IEC/EN 60664-1
Auxiliary to motor voltage:	4 kV / 2	IEC/EN 60664-1
Overvoltage category:	III	
EMC		
Interference resistance		
Electrostatic discharge:	8 kV (air)	IEC/EN 61000-4-2
HF-irradiation:		
80 Mhz ... 1.0 Ghz	10 V / m	IEC/EN 61000-4-3
1.0 GHz ... 2.5 GHz	3 V / m	IEC/EN 61000-4-3
2.5 GHz ... 2.7 GHz	1 V / m	IEC/EN 61000-4-3
Fast transients:	4 kV	IEC/EN 61000-4-4
Surge voltages between		
wire for power supply:	1 kV	IEC/EN 61000-4-5
between wire and ground:	2 kV	IEC/EN 61000-4-5
HF-wire guided:	10 V	IEC/EN 61000-4-6
Voltage dips:	IEC/EN 61000-4-11	
Interference emission		
Wire guided:	Limit value class B	IEC/EN 60947-4-2
Radio irradiation:	Limit value class B	IEC/EN 60947-4-2
Degree of protection		
Housing:	IP 40	IEC/EN 60529
Terminals:	IP 20	IEC/EN 60529
Vibration resistance:	Amplitude 0.35 mm	IEC/EN 60068-2-6
	frequency: 10 ... 55 Hz	
Climate resistance:	0 / 045 / 04	IEC/EN 60068-1

Technical Data	
Wire connection	
Load terminals:	1 x 10 mm ² solid 1 x 6 mm ² stranded ferruled
Stripping length:	11 mm
Control terminals:	1 x 4 mm ² solid or 1 x 2.5 mm ² stranded ferruled (isolated) or 2 x 1.5 mm ² stranded ferruled (isolated) DIN 46 228-1/-2/-3/-4 or 2 x 2.5 mm ² stranded ferruled DIN 46 228-1/-2/-3
Stripping length:	10 mm
Wire fixing	
Load terminals:	Plus-minus terminal screws M4 box terminals with wire protection
Control terminals:	Plus-minus terminal screws M4 box terminals with wire protection
Fixing torque	
Load terminals:	1.2 Nm
Control terminals:	0.8 Nm
Mounting:	DIN rail mounting IEC/EN 60715
Weight:	
Width 67.5 mm:	630 g
Width 90 mm:	780 g

Dimensions

Width x height x depth:	
BI 9028 up to 7.5 kW:	67.5 x 85 x 121 mm
BI 9028 up to 15 kW:	90 x 85 x 121 mm

Standard type

BI 9028.38	3 AC 200 ... 480 V	50/60 Hz	7.5 kW
Article number:	0054984		
• Motor voltage:	3 AC 200 ... 480 V		
• Nominal motor power at AC 400 V:	7.5 kW		
• Control input X1/X2			
• Width:	67.5 mm		

Varianten

BI 9028.38 /	3 AC 200 ... 480 V	50 / 60 Hz	11kW	U _H
			Aux. voltage	
			- Internal	
			- DC 24 V	
			- AC 400 V	
			- AC 115 / 230 V	
			- DC 24 V	
			Nominal motor power at 400V	
			- 7.5 kW	
			- 11 kW	
			- 15 kW	
			Nominal frequency	
			Phase / motor voltage	
			0 = Standard, control input X1+/X2	
			1 = Volt free contacts for Start (X1/X4) and Stop (X3/X4) or motor on (x1/x4) and brake on (X3/X4)	
			2 = Earth and volt free control contact Q1/Q2, status triggered	
			0 = Standard	
			1 = Input P1/P2/P3 for motor temperature monitoring	
			3 = Braking function can be switched off via control receipts for set-up operation	
			0 = Standard	
			1 = Start-/brake time 30 s Rel 1 energizes at start and de-energizes at stop	
			2 = Rel 1 switches with bypass relay	
			3 = Start-/brake time 30 s	
			4 = Start-/brake time 5 s Braking voltage DC 5 ... 65 V Braking delay time 100 ms	
			5 = Input X1, soft start On/Off Input X3, braking On/Off	
			6 = Rel 1 switches with the bypass relay start-/brake time 30 s	
			8 = Softstart /Softstop without brake Rel 1 switches with the bypass relay	
			Type	

Variants

BI 9028.38/_ _1:	Volt free contacts for start and stop X1, X2, X3, X4
BI 9028.38/_1_:	Input P ₁ / P ₂ / P ₃ to monitor the motor temperature
BI 9028.38/8_ _:	Softstop function instead of brake
BI 9028.38/_ _2:	Volt free control unit on terminals Q1/Q2
BI 9028.38/5_ _:	Softstart and brake function switching via control input X1, X3

Ordering example for variants:

BI 9028.38 /	3 AC 200 ... 480 V	50/60 Hz	11 kW
			Nominal motor power at AC 400 V
			Nominal frequency
			Phase / motor voltage
			Variant, if required
			Type

Available Variants

Type	Phase / motor voltage	Nom. frequency	Nom. motor power	Auxiliary voltage U _H	Article number
BI9028.38	3 AC 200 ... 480 V	50 / 60Hz	11 kW	AC 400 V	0065874
	3 AC 200 ... 480 V	50 / 60Hz	7,5 kW	AC 115 V / AC 230 V / DC 24 V	0054984
	3 AC 200 ... 480 V	50 / 60Hz	11 kW	AC 115 V / AC 230 V / DC 24 V	0054985
	3 AC 200 ... 480 V	50 / 60Hz	15 kW	AC 115 V / AC 230 V / DC 24 V	0055209
BI9028.38/001	3 AC 200 ... 480 V	50 / 60Hz	7,5 kW	AC 115 V / AC 230 V / DC 24 V	0055321
	3 AC 200 ... 480 V	50 / 60Hz	15 kW	AC 115 V / AC 230 V / DC 24 V	0056196
	3 AC 200 ... 480 V	50 / 60Hz	11 kW	AC 400 V	0055733
	3 AC 200 ... 480 V	50 / 60Hz	15 kW	AC 400 V	0055943
	3 AC 200 ... 480 V	50 / 60Hz	7,5 kW	AC 400 V	0056360
BI9028.38/010	3 AC 200 ... 480 V	50 / 60Hz	7,5 kW	AC 115 V / AC 230 V / DC 24 V	0055324
	3 AC 200 ... 480 V	50 / 60Hz	11 kW	AC 115 V / AC 230 V / DC 24 V	0055325
	3 AC 200 ... 480 V	50 / 60Hz	15 kW	AC 115 V / AC 230 V / DC 24 V	0058038
BI9028.38/011	3 AC 200 ... 480 V	50 / 60Hz	7,5 kW	AC 115 V / AC 230 V / DC 24 V	0055250
	3 AC 200 ... 480 V	50 / 60Hz	11 kW	AC 115 V / AC 230 V / DC 24 V	0055326
	3 AC 200 ... 480 V	50 / 60Hz	15 kW	AC 115 V / AC 230 V / DC 24 V	0056307
BI9028.38/231	3 AC 200 ... 480 V	50 / 60Hz	7,5 kW	AC 400 V	0064841
	3 AC 200 ... 480 V	50 / 60Hz	11 kW	AC 400 V	0064921
	3 AC 200 ... 480 V	50 / 60Hz	15 kW	AC 400 V	0064842
BI9028.38/501	3 AC 200 ... 480 V	50 / 60Hz	7,5 kW	AC 115 V / AC 230 V / DC 24 V	0064950
	3 AC 200 ... 480 V	50 / 60Hz	11 kW	AC 115 V / AC 230 V / DC 24 V	0064757
BI9028.38/511	3 AC 200 ... 480 V	50 / 60Hz	7,5 kW	AC 115 V / AC 230 V / DC 24 V	0067172
	3 AC 200 ... 480 V	50 / 60Hz	11 kW	AC 115 V / AC 230 V / DC 24 V	0065837
BI9028.38/600	3 AC 200 ... 480 V	50 / 60Hz	7,5 kW	AC 400 V	0064971
BI9028.38/800	3 AC 200 ... 480 V	50 / 60Hz	11 kW	AC 115 V / AC 230 V / DC 24 V	0056247
BI9028.38/810	3 AC 200 ... 480 V	50 / 60Hz	15 kW	AC 115 V / AC 230 V / DC 24 V	0057950
BI9028.38/812	3 AC 400 V	50 / 60Hz	11 kW	internal	0060865
	3 AC 400 V	50 / 60Hz	15 kW	internal	0062873

Control Input

With BI 9028 softstart begins by closing switch S and braking starts when opening switch S. When closing S during braking, softstart begins again.

With BI 9028/0_1 softstart begins by pressing the "Start" button (X1). By actuating the "Stop" button (X3) braking is started. Pressing the "Start" button during braking activates the softstart again. If "Start" and "Stop" are activated simultaneously within 0.1 s the stop function has priority.

On BI 9028/_ _2 softstarts begins when closing the contact on Q1/Q2. By opening this contact braking or softstop is started. If Q1/Q2 is permanently closed softstart is started when applying the mains voltage on L1/L2/L3. Start of braking or softstop can only be started by opening Q1/Q2.

With BI9028/5_ _ softstat begins with activation of input X1. The motor is connected to voltage until the signal is disconnected from the control input. With the signal on control input X3 the braking cycle is started (DC-brake) The braking cycle is finished when the signal on X3 is disconnected or on BI 9028/511 latest 60 seconds after start of the braking cycle the user has to make sure that only one control input is active.

Adjustment Facilities

Potentiometer	Description	Initial setting
M_{on}	Starting voltage	fully anti-clockwise
t_{on}	Ramp-up time	fully clockwise
I_{Br}	Braking current	fully anti-clockwise
t_{Br}	Braking time	fully clockwise
M_{off}	Deceleration voltage time	fully anti-clockwise
t_{off}	Deceleration time	fully clockwise

Set-up Procedure

Softstart:

1. Start the motor via control input X1/X2 and turn potentiometer " M_{on} " up until the motor starts to turn without excessive humming.
2. Adjust potentiometer " t_{on} " to give desired ramp time.
3. On correct setting the motor should accelerate up to nominal speed. If the start takes too long fuses may blow, especially on motors with high inertia.

- **Attention:** If the ramp-up time is adjusted to short, the internal bridging contact closes before the motor is on full speed. This may damage the bridging contactor or bridging relay.



Softstop:

- During softstop the device has to be connected to the voltage.
- Select softstop by opening control input X1/X2; Q1/Q2
- Turn potentiometer M_{off} to the left, until the motor starts visibly to slow down at the initiation of the softstop cycle.
- Adjust t_{off} until the required stopping time is achieved.

Braking:

The braking time t_{Br} and the braking current I_{Br} (max. $2 I_N$ with star connected and max. $2.8 I_N$ with delta connected motors, do not exceed max. permissible braking current!) is adjusted on BI 9028. The time has to be adjusted in a way that the current is flowing until the motor is on standstill. To avoid overload of braking device and motor, the braking current should be checked with a moving iron instrument (see connection diagram). The procedure für BI 9028/001 is the same.

Temperature Monitoring

BI 9028 features overtemperature monitoring of its internal power semiconductors. The unit is therefore protected against overheating during the set up procedure. BI 9028 can be reset after the semiconductors have cooled down by momentarily removing the auxiliary supply voltage.

Motor Blocking

If a motor is blocked and the blocking current can be over 100 A for more then 10 sec, then the motor current has to be monitored and disconnected from the BI 9028 by a contactor. When a motor overload device has tripped, the soft starter has to cool down for at least 3 minutes before restarting.

Safety Notes

- Never clear a fault when the device is switched on.
- **Attention:** This device can be started by potential-free contact, while connected directly to the mains without contactor (see application example). Please note, that even if the motor is at rest, it is not physically separated from the mains. Because of this the motor **must** be disconnected from the mains via the corresponding manual motor starter.
- The user must ensure that the device and the necessary components are mounted and connected according to the locally applicable regulations and technical standards.
- Adjustments may only be carried out by qualified specialist staff and the applicable safety rules must be observed.



Connection Example

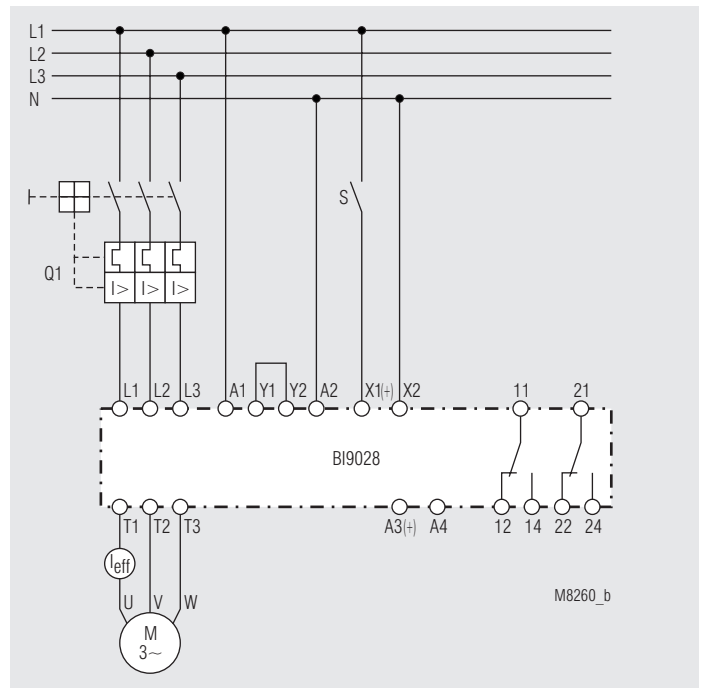

BI 9028 softstart and brake function with switch S

Connection Examples

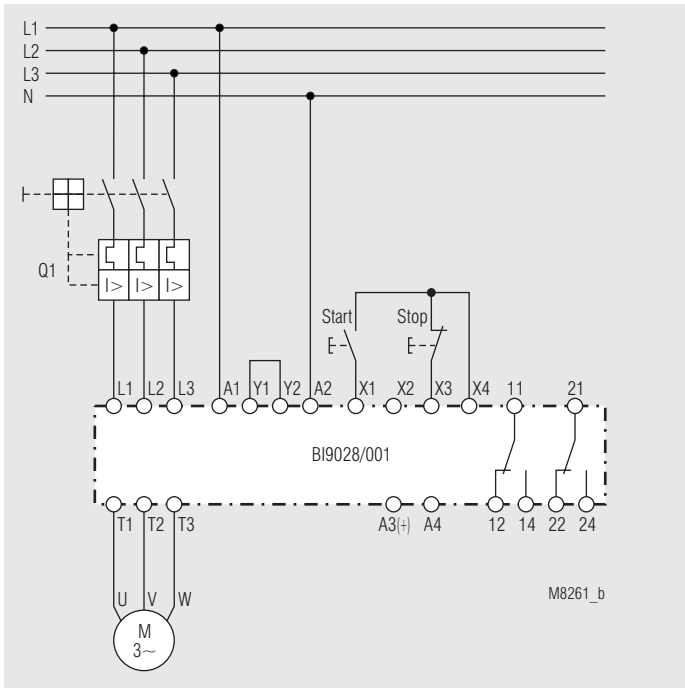

BI 9028/001 softstart with start-button, brake function with stop-button

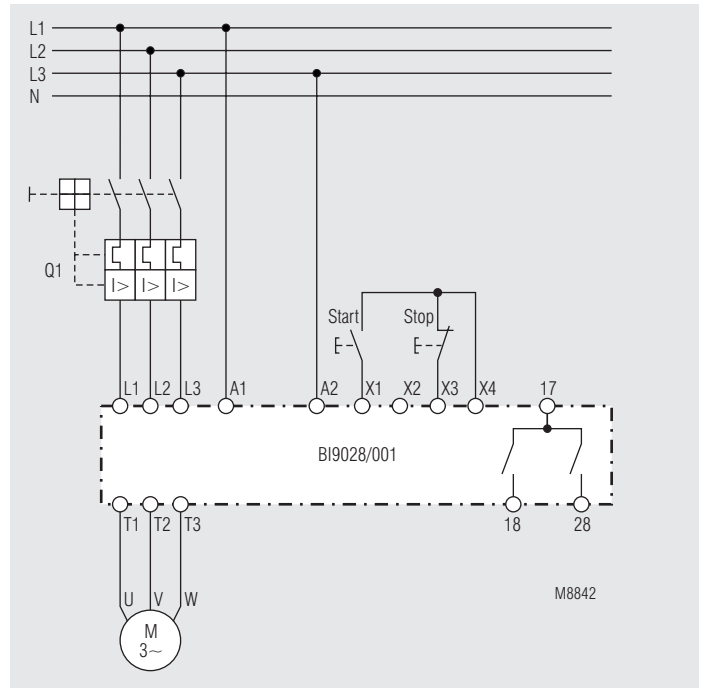

BI 9028/001, $U_H = AC\ 400\ V$

Connection Examples

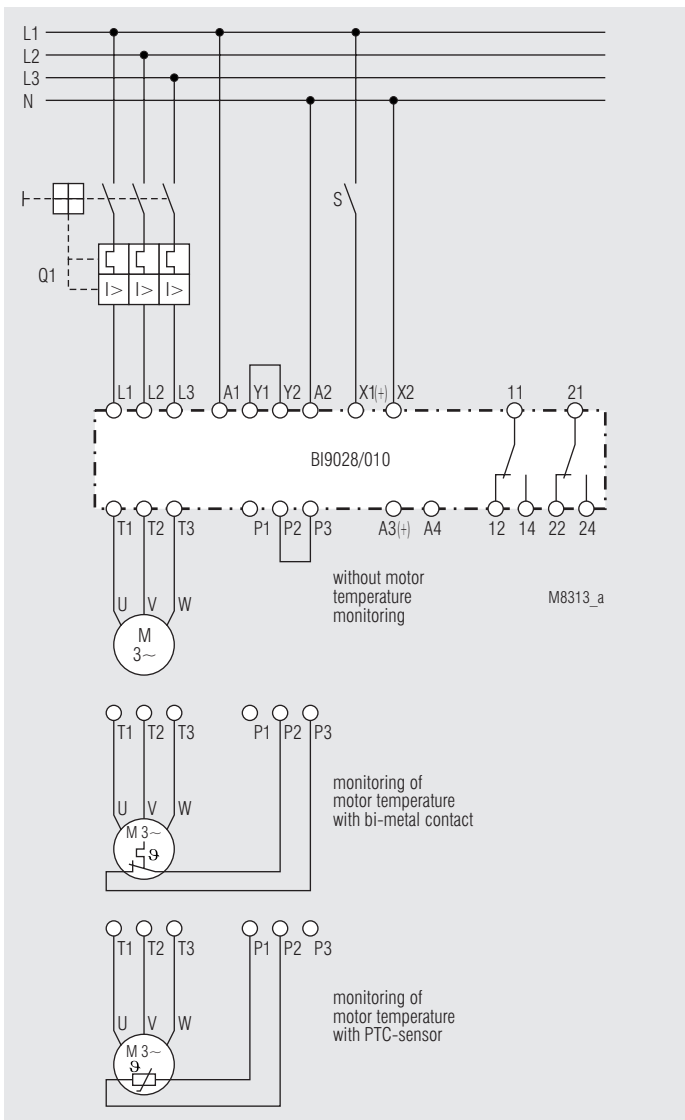

BI 9028/010 softstart and brake function with motor temperature monitoring

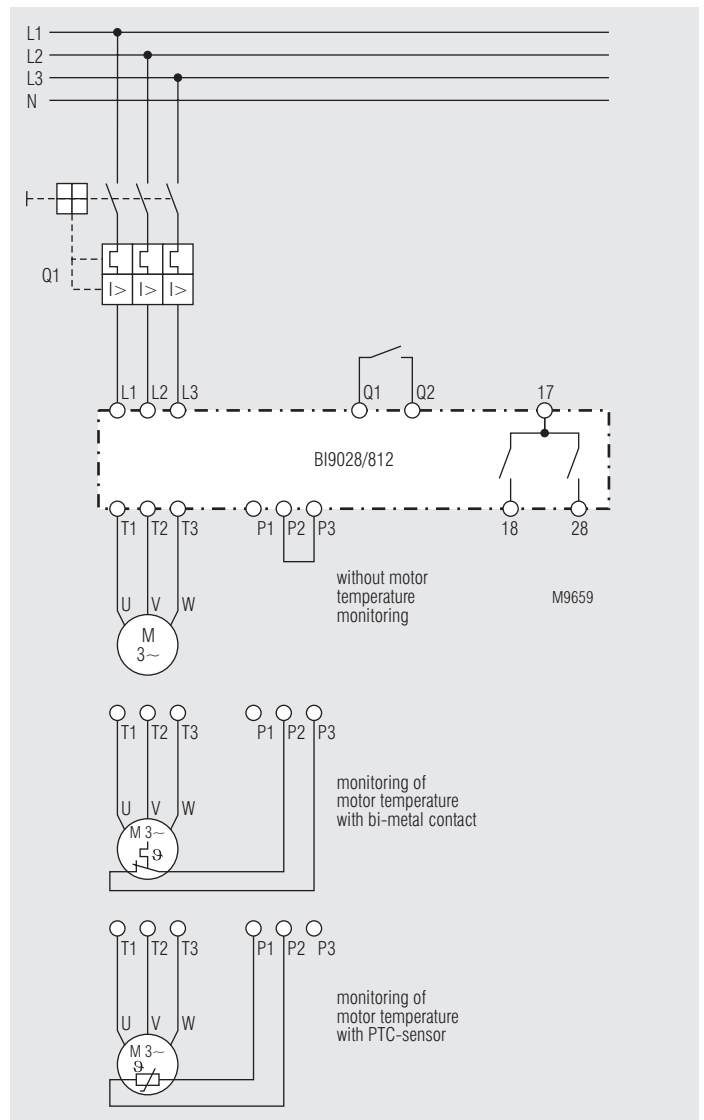

BI 9028/010 softstart - softstop with monitoring of motor temperature without auxiliary voltage.

Connection Examples

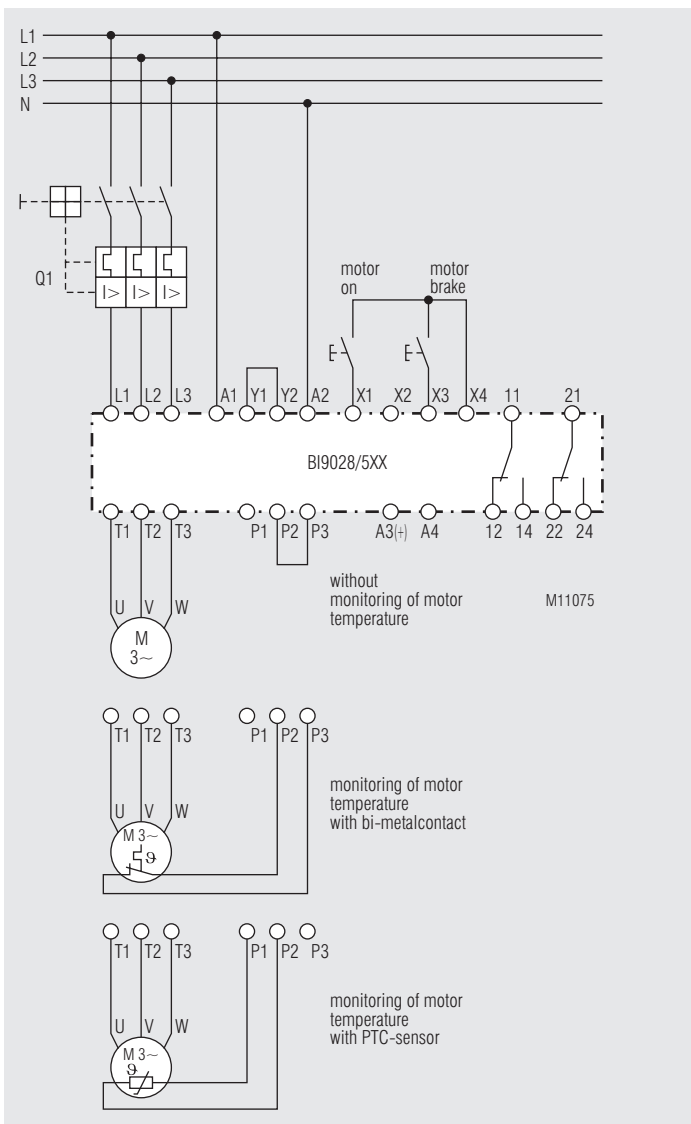

BI 9028/5_ _softstart and brake function switching via separate control inputs, auxiliary voltage $U_H = AC 230 V$

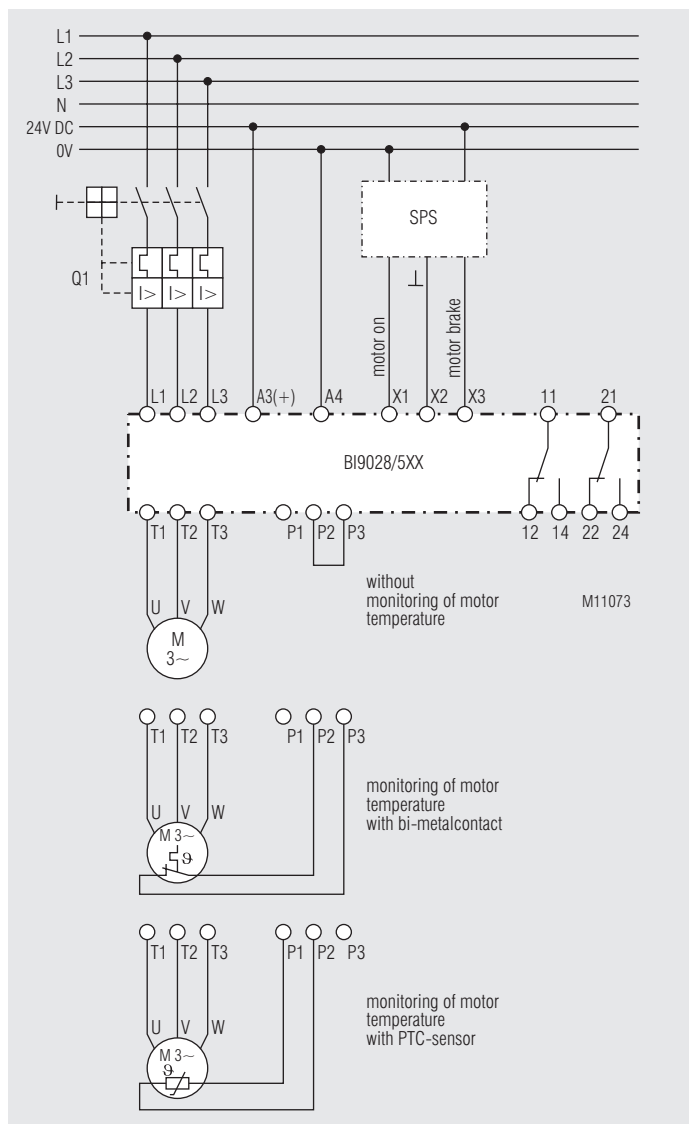

BI 9028/5_ _softstart and brake function switching via separate control inputs, auxiliary voltage $U_H = DC 24 V$

