

Atlantic metal enclosures

IP 55/IP 66 - IK 10 - Type 4x - Type 12

Usable dimensions

Doors

2 doors

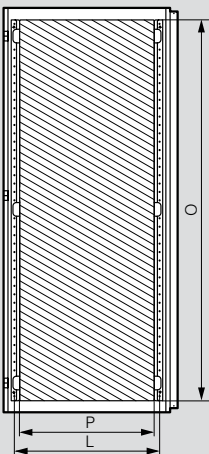

1 door

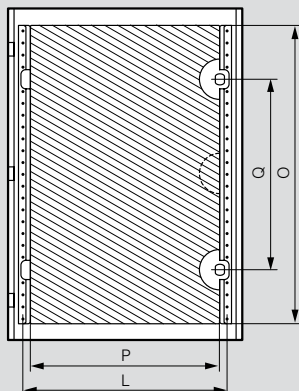

Cat. Nos.	Enclosures		Door usable dimensions		Lock positions Q (mm)	Strand-holder fixing centres L (mm)
	Height (mm)	Width (mm)	Height O (mm)	Width P (mm)		
0369 10	300	200	251	148 ⁽³⁾	(1)	(2)
0369 17/12/27	400	300	351	248 ⁽³⁾	(1)	(2)
0369 13/18/28	500	400	451	300	(1)	330
0369 19/26/29/36	600	400	551	300	350	330
0369 20	600	500	551	400	350	430
0369 21/30/40	700	500	651	400	400	430
0369 25	500	400	451	300	(1)	330
0369 31/37/41/44/47	800	600	751	500	500	530
0369 32/38/48	1000	600	951	500	(1)	530
0369 33/39/45/49	1000	800	951	700	(1)	730
0369 42	1200	600	1151	500	(1)	530
0369 43/46/56	1200	800	1151	700	(1)	730
0369 50/60	1400	800	1351	700	(1)	730
0369 51/55	300	300	251	248 ⁽³⁾	(1)	(2)
0369 57	400	400	351	348 ⁽³⁾	(1)	(2)
0369 59/62	500	500	451	400	(1)	430
0369 64/72/74	600	600	551	500	350	530
0369 68	800	800	751	700	500	730
0369 11/75	300	400	251	348 ⁽³⁾	(1)	(2)
0369 76/77	400	600	351	500	(1)	530
0369 78	600	800	551	300 x 2	(1)	330
0369 79	600	1000	551	400 x 2	(1)	430
0369 80	800	1000	751	400 x 2	(1)	430
0369 81	1000	1200	951	500 x 2	(1)	530

1: Central lock
2: Without strand-holder
3: -12 mm on the side with "Legrand" marking

Usable depth

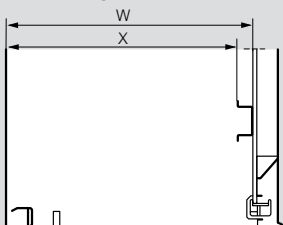

Enclosures Depth (mm)	Back of enclosure	
	W (mm)	X (mm)
160	140	125
200	180	165
250	230	215
300	280	265
400	380	365

Cable entries

Enclosures width ≤ 800 mm

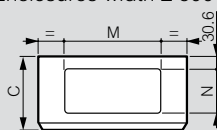

Enclosures width ≥ 1000 mm

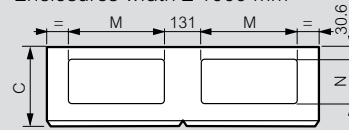

Enclosures (mm)		Dimensions of cable entries (mm)		
Width	Depth	C	M	N
200	160	170	-	-
300	160	170	-	-
400	160	170	-	-
300	200	210	169	115
400	200	210	269	115
400	250	260	269	115
500	200	210	269	115
600	200	210	269	115
500	250	260	369	150
500	300	310	369	150
600	250	260	469	150
600	300	310	469	150
600	400	410	469	150
800	250	260	469	150
800	300	310	469	150
800	400	410	469	150
1000	300	310	369	150
1200	300	310	469	150

Plinths

Trap doors

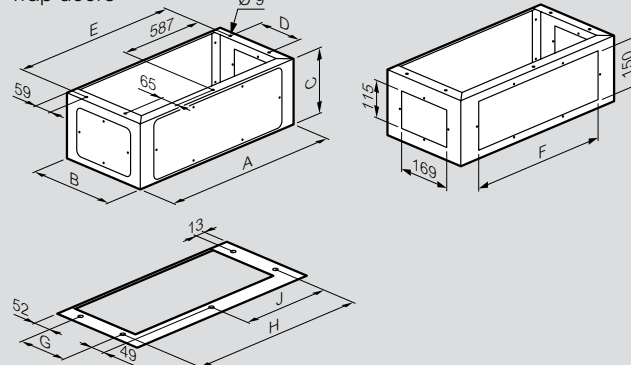

Cat. Nos.	Enclosures W x D (mm)	A	B	C	D	E	F	G	H	J
0363 00	600 x 300	600	280	200	150	574	469	150	542	271
0363 01	800 x 300	800	280	200	150	774	469	150	742	371

Roofs fixing

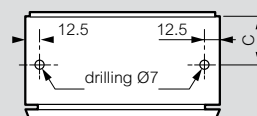

Cat. Nos.	C (mm)
0365 51/52/67/68	100
0365 53/54/64	125
0365 56/57	150