

AI-FSS-2

The AI is a single key access interlock ideal for use on hinged doors. The interlock has an open cavity design manufactured in either aluminium alloy/brass or stainless steel, making it ideal for use in harsh or corrosive environments and heavy use. Typical industries using the AI are food, chemical, pharmaceutical, mining, steel and power generation.

Operation

The Castell single key access interlocks are used in various applications to control part body access to hazardous areas.

AI single key access interlock (bolt trapped - key free)

① Key is free, bolt is trapped

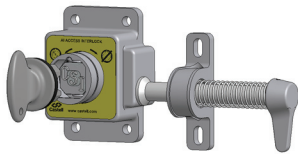

② Insert and turn key, then turn and release bolt

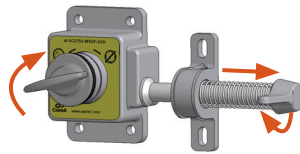

③ Key is trapped, bolt is unlocked

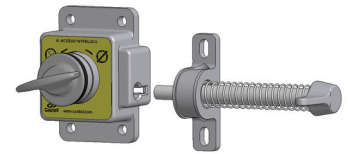

1. While the key is free, the bolt of the AI is trapped in the mechanism. The door is locked.
2. By inserting and turning the key in the Access Interlock, you can release the bolt. This will trap the key in the lock.
3. The key stays trapped while the bolt is released and the door is open.

Usage

The AI Access Interlock should be used to allow safe access to potential hazardous and dangerous areas. The AI Access Interlock should be used on part body access doors where the use of personal safety keys is not essential (to prevent accidental lock in).



The AI Access Interlock is not designed for security purposes, such as a safe or external access to a building.

No hazardous substances were used in the manufacture of this product. The product can be disposed of in standard waste.

Installation

The housing of the AI access interlock should normally be mounted on the static frame of the guard and the bolt to the sliding or hinged door using suitable fasteners. Fixed bolt bracket is highly tolerant to misaligned guards and should be fitted with suitable fasteners. Please refer to the drawing on page 4 for mounting details for the housing and bolt. The AI interlocks are available in Hand 1 and Hand 2 version suitable for left or right hinged doors, respectively. Anti vibration pads should be used on machines that generate a high level of vibration.



IMPORTANT:

The AI Access Interlock should be mounted on the guard using anti-tamper fasteners to prevent unauthorised removal.



The AI Access Interlock must be installed by a competent and qualified person who has read and understood these instructions. Please retain this document in your technical file.

Force required to shear lock bolt is 24KN for both stainless steel and brass interlocks.

Maintenance

Periodic visual checks should be carried out by the site manager/safety officer. Do not lubricate lock barrel with oil or grease, use CK Dry Powder Graphite if necessary.



In case of defects being detected please contact your nearest Castell Support Department for further actions. Please see Contact section for contact details.

Technical Data

Temperature rating	Minimum: -40°C [-40°F] ice free for Q & FS Type
	Maximum: 107°C [224,6°F] for Q Type/140°C [284°F] for FS Type
Type of mounting	Surface mount using suitable fasteners (please refer to drawing on page 4 for more details)
Weight	Brass: 0,8 kg
	Stainless steel: 1,0 kg
Material	Aluminium alloy/brass or stainless steel
MTTF Certification	Available on request

Application

A typical application of the AI Single Key Access Interlock is machine guarding with part body access.

The AI is used as a part of a safety system, which ensures a machine is shut down, before access to the hazardous area is allowed.

The system involves a KS key switch that breaks the machine safety circuit, when the key is removed. The key can then be taken to the AI Access Interlock to enable access to the machine. The machine cannot be restarted until the door is closed, the bolt is replaced and the key is removed and taken to the KS key switch.

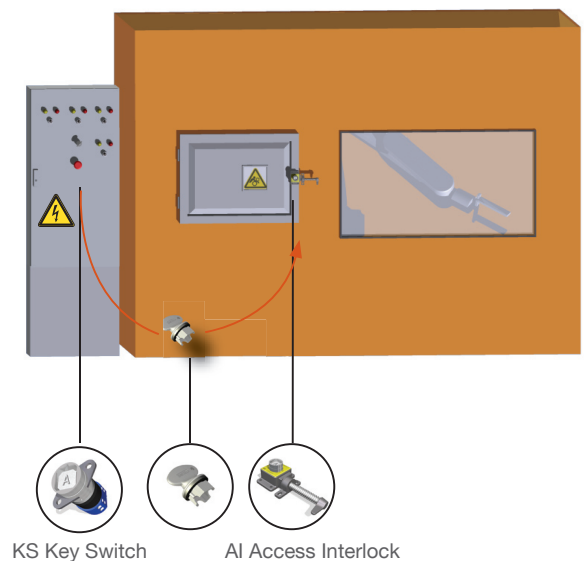

EC-Declaration

We, the manufacturers, declare that the components, detailed herein and placed on the market, comply with all the essential health and safety requirements applying to them.

Empowered signatory:

Mr T.C. Whelan
Managing Director



Drawing

Dimensions:
in mm

Note: For safe mounting, use security screws

AI, Hand 2

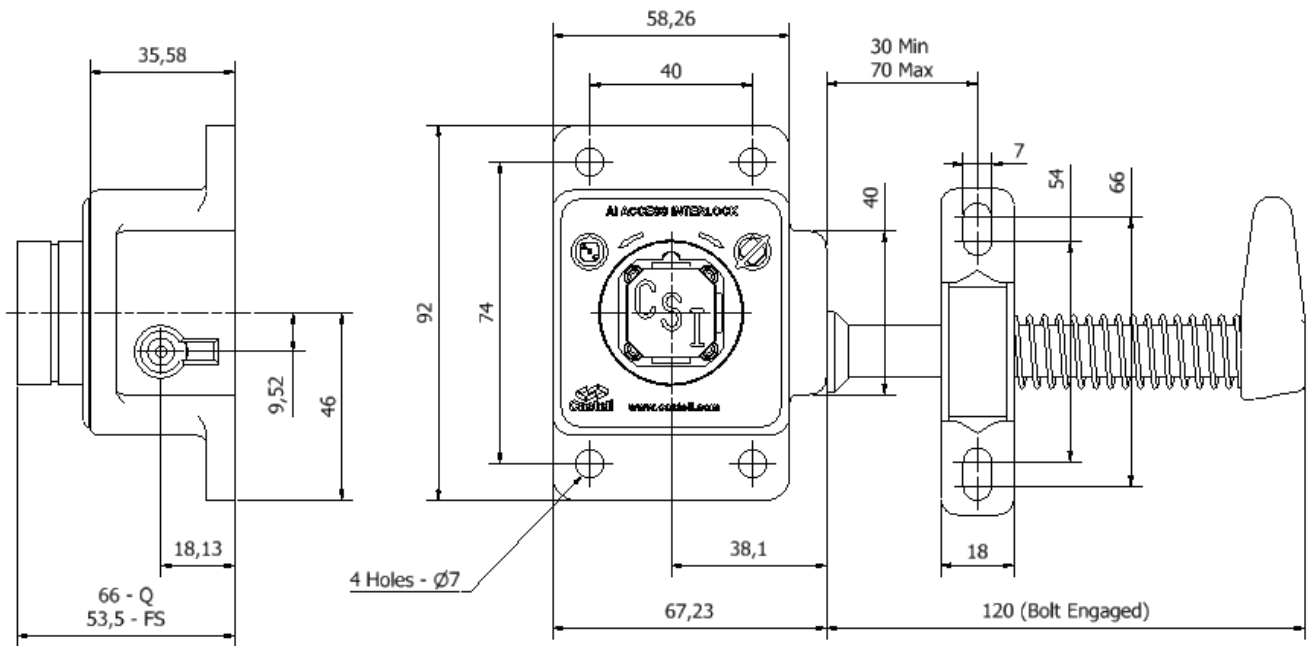

Order Information

	Product Type	1	2	3
Part Number	AI			
Example	AI	FS	AL	1
	4			
	ABC			

1	Lock portion type	FS ⁽¹⁾ / Q ⁽¹⁾
2	Material	AL = Aluminium alloy/brass S = Stainless steel
3	Handing	1 = left hinged door (bolt enters left) ⁽²⁾ 2 = right hinged door (bolt enters right) ⁽²⁾
4	Lock portion symbol	FS ⁽¹⁾ up to 3 characters / Q ⁽¹⁾ up to 6 characters

(1) **FS - Lock type** Up to 3 characters **Q - Lock type** Up to 6 characters



(2) **Handing** **1** **2**

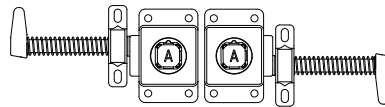

Special construction available upon enquiry

Accessories

	Product	Part number
	Flip Cap	FLIP-S

Contact Information

Castell Safety International Ltd.
The Castell Building
217 Kingsbury Road
London, England NW9 9PQ

t: +44 (0) 20 8200 1200
f: +44 (0) 20 8905 9378
e: uksales@castell.com

Castell Safety International Ltd.
Oskar-Jäger-Strasse 137
50825 Köln
Germany

t: +49 (0) 221 1649 794
f: +49 (0) 221 1649 795
e: vertrieb@castell.com

Castell Interlocks Inc.
Suite 800
150 N Michigan Avenue,
Chicago, Illinois 60601
USA

t: +1.312.360.1516
f: +1.312.268.5174
e: ussales@castell.com

Castell Safety China
Building 1, No. 123,
Lane 1165, Jindu Road,
Minhang District,
Shanghai 201108, China.

t: +86 21 61519023
f: +86 21 61519030
e: chinasales@castell.com

While every effort has been made to ensure the accuracy of the information provided, no liability can be taken for any errors or omission. Castell Safety International Limited reserves the right to alter specifications and introduce improvements without prior notice.