

V1000

AC Drive Series



One for all

The V1000 is a compact general purpose AC drive covering the demands of a wide range of applications. Simple duties as well as requirements of complex systems need a higher level of functionality, reliability and easy handling, which are the key features of the V1000.

Wherever you are -
Our support team is always close to you

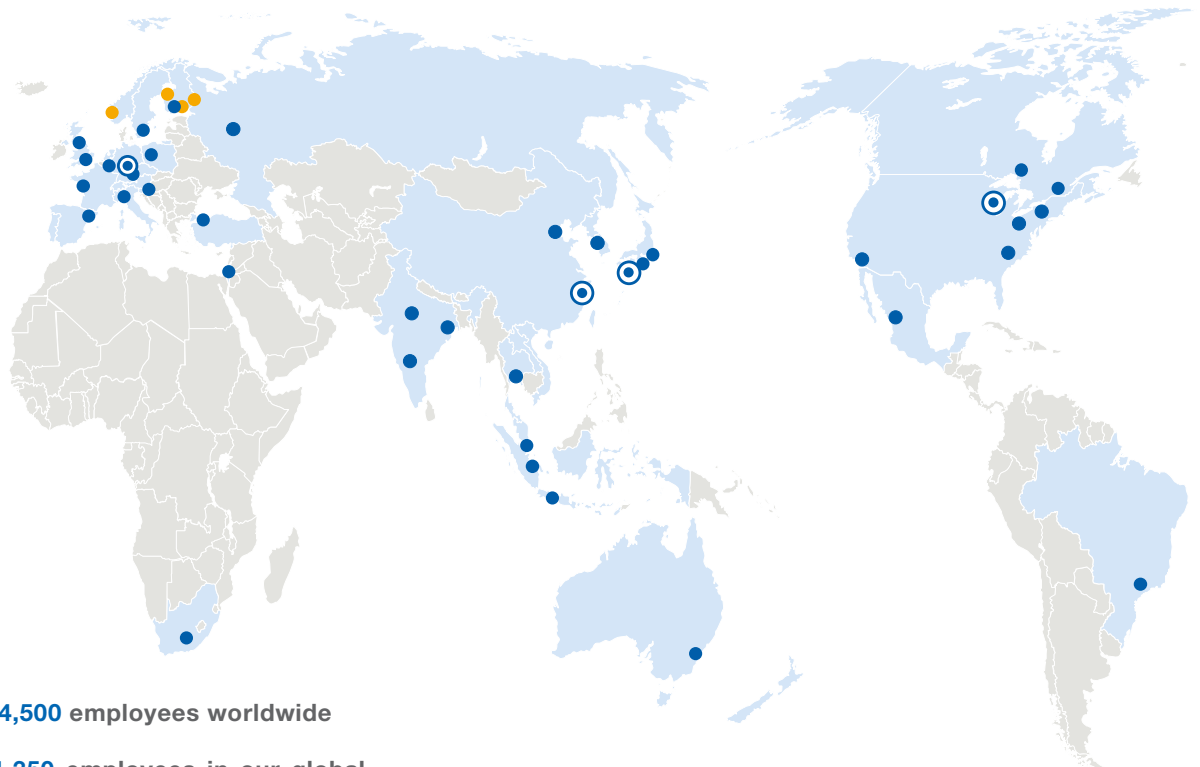

More than **14,500** employees worldwide

More than **1,350** employees in our global service network

More than **1,600** employees in europe

Easy and cost-saving

This extremely compact and powerful drive sets standards in terms of user friendliness and process orientation. It was developed for efficient production and better maintainability with major focus on performance and reliability.

Functional safety integrated

The V1000 has a built in two-channel Safe Torque Off (STO) function (SIL2, PL-d, IEC 61800-5-2). Safe Torque Off minimizes downtime for applications requiring occasional intervention and it helps to reduce the number of installed components in your system.

Cold Plate type

YASKAWA has as one of the first manufacturers promoted the development of Cold Plate type inverters for the European and international markets. Consequently the V1000 is available as Cold Plate version for applications with an external cooling system. Cold Plate means also no fans inside the drive, which makes the V1000 the preferred solution for hazardous environments.

Features

- Functional Safety built in, STO according to ISO 13849-1 Cat 3, PL-d and IEC 61800-5-2, SIL2
- Worldwide specification: CE, UL, cUL, RoHS
- 150% inverter overload performance for excellent starting torque
- Induction Motor (IM) and Permanent Magnet (PM) motor control for highly efficient applications
- Dynamic braking: The unique High Flux Braking method reduces the stopping time by up to 50% compared to conventional methods without braking resistor
- Protection class: IP20/Open-Chassis, NEMA Type 1, or IP66. The IP66 units are available with or without LED keypad
- Optional high output frequency version for spindles and other high speed applications
- V/f and open-loop current vector control
- Predictive maintenance function
- Compact space saving design ready for side-by-side mounting
- Cooling fan replacement without tools
- Icon-based programming
- Designed for 10 years of maintenance-free operation



Easy. Reliable. Quick.



Easy installation

The YASKAWA V1000 reduces installation time and costs.

- One of the smallest AC drives in the world. Saves mounting space and cost by side-by-side mounting
- Application parameter presets to shorten commissioning time
- Same handling and parameter structure for all YASKAWA AC drives
- DriveWorksEZ icon-based programming tool. Simply drag and drop icons to customize your drive. Create customized sequences without an external PLC



Reliable operation

The V1000 continues the tradition of YASKAWA by being the reliable link in your production chain.

- Designed for long performance life (10 years 24 h per day at 80% nominal load, +40 °C ambient temperature)
- Quick response on load and speed changes improves your machine performance
- Online Auto-Tuning for improved motor performance at low speed
- Optional external 24 VDC supply assures communication and data flow in any power-loss situation
- High speed performance: The V1000 controls the application with a super-fast 2 ms scan rate

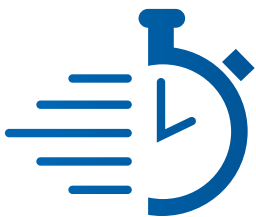

Quick maintenance

The YASKAWA V1000 is an AC drive which adapts to user demands and provides maintenance functions that ensure quick replacement and minimize down time.

- Removable terminal board with parameter memory for quick and easy maintenance
- Screw-less control terminal saves setup time
- Predictive maintenance function showing the lifetime of IGBT, Capacitor, Cooling Fan and Soft Charge Bypass Relay on the display

For a wide range of applications



- Pumps
- Fans and blowers
- Compressors

- Conveyor belts
- Transport systems
- and many other applications

Software Functions

IM/PM Control

Supports Induction Motor (IM) and Permanent Motor (PM) control. The V1000 controls Interior Permanent Magnet (IPM) and Surface-mounted Permanent Magnet (SPM) as well as standard Induction Motors.

Motor 2 Selection

One drive runs two motors. Use a single drive to operate two different motor settings.

Intelligent Stall Prevention

Optimal acceleration/deceleration without external adjusting. Drive stops always in shortest possible times based on the load condition.

High Slip Braking

Reduces the deceleration time without braking option. Shortens motor stop time by reducing the output frequency in large steps. So created regenerative energy in the motor reduces the stopping time compared to conventional stopping method.

Speed Search

Start a coasting motor. The motor operation can be directly started from the speed detected without motor speed feedback.

Dwell Function

Accelerate and decelerate smoothly with large inertia loads. Drive prevents speed control loss by temporarily lock of output frequency at certain level during acceleration and deceleration.

Accel/Decel Time Switch

Switch easily between accel/decel times. Switch acceleration and deceleration rates when running two motors from the same drive, or automatically switch to different application based accel/decel times at different speed ranges.

PID Control

Automatic PID control. The internal PID controller manages control of system variables such as pressure, temperature or flow by automatically adjusting of drives output frequency.

Energy Saving

Application control at top efficiency. The Energy Saving feature improves overall system operating efficiency by operating the motor at its most efficient level. This is accomplished by continuously monitoring the motor load and controlling the motor so that it always operates near its rated slip frequency.

Torque Limit

Improves application reliability and protects the system. Torque limit function helps to protect motor load in continuous operation in each of the four quadrants individually. The drives output is controlled according the overload status.



Momentary Power Loss

Keep running even during a short momentary power loss. Automatically return to the operation condition it was performing before main power down.

General Stall Prevention

General Purpose Stall Prevention. The drive allows smoothly lowering the speed by preset deceleration time. It controls the DC bus voltage and if required pauses the deceleration to avoid an overvoltage fault.

Application Presets

Application Presets. Several application presets like Pump, Conveyor, Fan, Compressor or Hoist are available. Selecting one of these applications minimizes the drive commissioning time to minimum.

Application Presets

Achieve high level of performance. The drive comes with current vector control capabilities for high performance applications.

PTC Input

Thermal Protection by PTC located in the motor windings. Protect the motor from overheating by PTC connected to the V1000.

Overexcitation Braking

Perfect for applications with high load inertia that rarely need to be stopped. Stop quickly (up to 50% faster) without the use of a braking resistor.

Note: Stopping times may vary based on motor characteristics.

SPECIAL SOFTWARE

Customized Application Software.



Kinetic Energy Buffering

Continuous operation even during a momentary power loss without drives output off. Uses regenerated energy from the motor to bring the application to a controlled stop rather than just coast to stop. This allows the drive to continue running without interrupting the output power during a momentary power loss.

DriveWorksEZ

Built-in drive PLC functionality. DriveWorksEZ is a software package that to customize the drive functionality or add PLC functionality by the interconnection and configuration of basic software function blocks.

Technical specification

Power ratings

Single-phase, 200 VAC

Inverter model CIMR-VCBA*1	0001	0002	0003	0006	0010	0012	0018*6
Motor output (normal duty) [kW]*2	0.18	0.37	0.75	1.1	2.2	3.0	-
Motor output (heavy duty) [kW]*5	0.1	0.18	0.55	0.75	1.5	2.2	4.0
Rated output current (normal duty) [A]*3	1.2	1.9	3.3	6.0	9.6	12.0	-
Rated output current (heavy duty) [A]*5	0.8	1.6	3.0	5.0	8.0	11.0	17.5
Overload	120% for 60 sec normal duty, 150% for 60 sec heavy duty from inverter rated output current						
Rated output power (normal duty) [kVA]	0.5	0.7	1.3	2.3	3.7	4.6	-
Rated output power (heavy duty) [kVA]	0.3	0.6	1.1	1.9	3.0	4.2	6.7
Max. output voltage	Three-phase 200 to 240V (proportional to input voltage)						
Max. output frequency	400Hz						
Rated input voltage	Single-phase 200 to 240V +10%/-15%						
Rated input frequency	50/60 Hz +/-5%						

Three-phase, 200 VAC

Inverter model CIMR-VC2A	0001	0002	0004	0006	0010	0012	0020	0030	0040	0056	0069
Motor output (normal duty) [kW]*2	0.18	0.37	0.75	1.1	2.2	3.0	5.5	7.5	11.0	15.0	18.5
Motor output (heavy duty) [kW]*5	0.1	0.2	0.4	0.75	1.5	2.2	4.0	5.5	7.5	11.0	15.0
Rated output current (normal duty) [A]*3	1.2	1.9	3.5	6.0	9.6	12.0	19.6	30.0	40.0	56.0	69.0
Rated output current (heavy duty) [A]*5	0.8	1.6	3.0	5.0	8.0	11.0	17.5	25.0	33.0	47.0	60.0
Overload	120% for 60 sec normal duty, 150% for 60 sec heavy duty from inverter rated output current										
Rated output power (normal duty) [kVA]	0.5	0.7	1.3	2.3	3.7	4.6	7.5	11.4	15.2	21.3	26.3
Rated output power (heavy duty) [kVA]	0.3	0.6	1.1	1.9	3.0	4.2	6.7	9.5	12.6	17.9	22.9
Max. output voltage	Three-phase 200 to 240V (proportional to input voltage)										
Max. output frequency	400Hz										
Rated input voltage	Single-phase 200 to 240V +10%/-15%										
Rated input frequency	50/60 Hz +/-5%										

Three-phase, 400 VAC

Inverter model CIMR-VC4A	0001	0002	0004	0005	0007	0009	0011	0018	0023	0031	0038
Motor output (normal duty) [kW]*2	0.37	0.75	1.5	2.2	3.0	4.0	5.5	7.5	11.0	15.0	18.5
Motor output (heavy duty) [kW]*5	0.37	0.55	1.1	1.5	2.2	3.0	4.0	5.5	7.5	11.0	15.0
Rated output current (normal duty) [A]*3	1.2	2.1	4.1	5.4	6.9	8.8	11.1	17.5	23.0	31.0	38.0
Rated output current (heavy duty) [A]*5	1.2	1.8	3.4	4.8	5.5	7.2	9.2	14.8	18.0	24.0	31.0
Overload	120% for 60 sec normal duty, 150% for 60 sec heavy duty from inverter rated output current										
Rated output power (normal duty) [kVA]	0.9	1.6	3.1	4.1	5.3	6.7	8.5	13.3	17.5	23.6	29.0
Rated output power (heavy duty) [kVA]	0.9	1.4	2.6	3.7	4.2	5.5	7.0	11.3	13.7	18.3	23.6
Max. output voltage	Three-phase 380 to 480V (proportional to input voltage)										
Max. output frequency	400Hz										
Rated input voltage	Three-phase 380 to 480V +10%/-15%										
Rated input frequency	50/60 Hz +/-5%										

*1 Drives with a single-phase power supply input have three-phase output. Single-phase motors cannot be used.

*2 The motor capacity (kW) refers to a YASKAWA 4-pole, 60 Hz, 200 V motor. The rated output current of the drive output amps should be equal to or greater than the motor rated current.

*3 At 2 kHz carrier frequency without derating

*4 At 10 kHz carrier frequency without derating

*5 At 8 kHz carrier frequency without derating

*6 Only heavy duty rating available

Model code

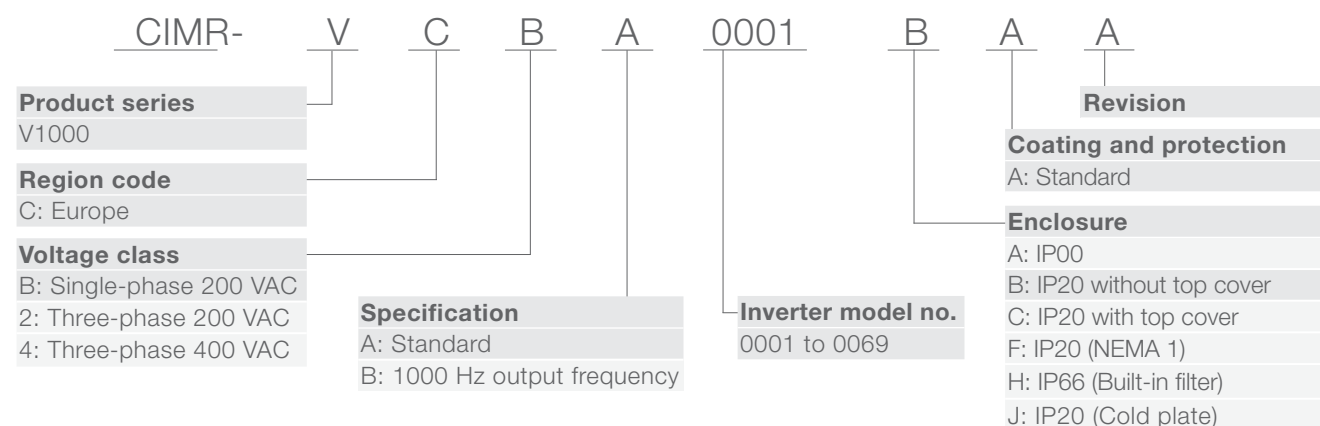

Specifications

Control functions	
Control methods	Open loop vector control (Current vector), V/f control, PM open loop vector control (for SPM and IPM motors)
Frequency control range	0.01 to 400Hz
Frequency accuracy (Temperature fluctuation)	Digital input: within $\pm 0.01\%$ of the max. output frequency (-10°C to $+50^{\circ}\text{C}$) Analog input: within $\pm 0.1\%$ of the max. output frequency ($25^{\circ}\text{C} \pm 10^{\circ}\text{C}$)
Frequency setting resolution	Digital input: 0.01 Hz Analog input: 1/1000 of max. frequency
Starting torque	200 % / 0.5Hz (assumes heavy duty rating AC motor of 3.7 kW or less using open loop vector control), 50 % / 6Hz (assumes PM open loop vector control)
Speed control range	1:100 (Open loop vector control), 1:40 (V/f control), 1:10 (PM open loop vector control)
Speed control accuracy	$\pm 0.2\%$ in open loop vector control ($25^{\circ}\text{C} \pm 10^{\circ}\text{C}$)*1
Speed response	5Hz in open loop vector ($25^{\circ}\text{C} \pm 10^{\circ}\text{C}$) (requires rotational auto-tuning)
Torque limit	Open loop vector control allows separate settings in four quadrants
Accel/Decel time	0.0 to 6,000.0s (4 selectable combinations of independent acceleration and deceleration settings)
Braking torque	<ul style="list-style-type: none"> Short-time decel torque*2: over 150 % for 0.1/0.2kW motors, over 100 for 0.4/0.75kW motors, over 50 % for 1.5kW motors, over 20 % for 2.2kW and above motors (overexcitation braking/high-slip braking: approx. 40 %) Continuous regen. torque: approx. 20 % (approx. 125 % with dynamic braking resistor option*3: 10 % ED, 10s, internal braking transistor)
V/f characteristics	User-selected programs, V/f preset patterns possible
Main control functions	Momentary power loss ride-thru, Speed search, Overtorque detection, Torque limit, 17-step speed (max), Accel/decel time switch, S-curve accel/decel, 3-wire sequence, Auto-tuning (rotational, stationary tuning for resistance between lines), Dwell, Cooling fan on/off switch, Slip compensation, Torque compensation, Frequency jump, Upper/lower limits for frequency reference, DC injection braking at start and stop, Overexcitation braking, High slip braking, PID control (with sleep function), Energy saving control, MEMOBUS comm. (RS-485/422 max, 115.2kbps), Fault restart, Application presets, DriveWorksEZ (customized function), Removable terminal block with parameter backup function...
Protection functions	
Motor protection	Motor overheat protection based on output current
Momentary overcurrent protection	Drive stops when output current exceeds 200 % of heavy duty rating
Overload protection	Drive stops after 60s at 150 % of rated output current (heavy duty rating)*4
Overvoltage protection	200 V class: Stops when DC bus exceeds approx. 410 V 400 V class: Stops when DC bus exceeds approx. 820 V
Undervoltage protection	Stops when DC bus voltage falls below the following levels: 190 V (3-phase 200V), 160V (single-phase 200V), 380 V (3-phase 400V), 350V (3-phase 380V)
Momentary power loss ride-thru	Stops after approx. 15ms (default). Parameter settings allow the drive to continue running if power loss lasts for up to approx. 2s*5
Heatsink overheat protection	Protection by thermistor
Braking resistance overheat protection	Overheat sensor for braking resistor (optional ERF-type, 3 % ED)
Stall prevention	Separate settings allowed during acceleration, and during run. Enable/disable only during deceleration.
Ground fault protection	Protection by electronic circuit*6
Charge LED	Charge LED remains lit until DC bus has fallen below approx. 50V
Operating environment	
Area of use	Indoors
Ambient temperature	-10°C to $+50^{\circ}\text{C}$ (open chassis), -10°C to $+40^{\circ}\text{C}$ (NEMA Type 1)
Humidity	95 RH% or less (non-condensing)
Storage temperature	-20°C to $+60^{\circ}\text{C}$
Altitude	1,000m without derating (output derating of 1 % per 100m above 1,000m, max. 3,000m)
Vibration	10 to 20Hz (9.8 m/s^2), 20 to 55Hz (5.9 m/s^2)
Standards	CE, UL, cUL, RoHS
Protective Design	IP20 open-chassis, NEMA Type 1 enclosure, IP66

*1 Speed control accuracy may vary slightly depending on installation conditions or motor used.

*2 Momentary average deceleration torque refers to the deceleration torque from 60 Hz down to 0 Hz. This may vary depending on the motor.

*3 If L3-04 is enabled when using a braking resistor or braking resistor unit, the motor may not stop within the specified deceleration time.

*4 Overload protection may be triggered at lower levels if output frequency is below 6 Hz.

*5 Varies by drive capacity. Drives smaller than 7.5 kW require a separate Momentary Power Loss Recovery Unit to continue operating during a momentary power loss of 2s.

*6 Protection may not be provided under the following conditions as the motor windings are grounded internally during run:

Low resistance to ground from the motor cable or terminal block.

Drive already has a short-circuit when the power is turned on.

Dimensions

All dimensions in mm, weights in kg.

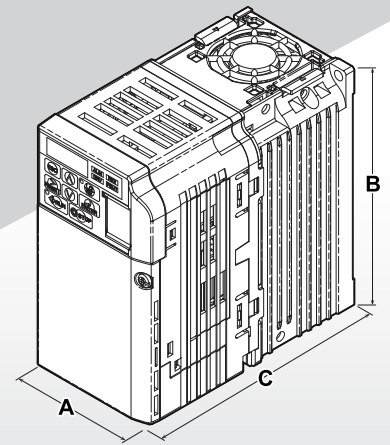

IP20/Open-chassis (without EMC filter)

Single-phase, 200 VAC

Model CIMR-VC□	A	B	C	kg
BA0001B	68	128	76	0.6
BA0002B	68	128	76	0.6
BA0003B	68	128	118	1.0
BA0006B	108	128	137.5	1.7
BA0010B	108	128	154	1.8
BA0012B	140	128	163	2.4
BA0018B	170	128	180	3.0

Three-phase, 200 VAC

Model CIMR-VC□	A	B	C	kg
2A0001B	68	128	76	0.6
2A0002B	68	128	76	0.6
2A0004B	68	128	108	1.0
2A0006B	68	128	128	1.1
2A0010B	108	128	129	1.7
2A0012B	108	128	137.5	1.7
2A0020B	140	128	143	2.4

Three-phase, 400 VAC

Model CIMR-VC□	A	B	C	kg
4A0001B	108	128	81	1.0
4A0002B	108	128	99	1.2
4A0004B	108	128	137.5	1.7
4A0005B	108	128	154	1.7
4A0007B	108	128	154	1.7
4A0009B	108	128	154	1.7
4A0011B	140	128	143	2.4

IP20/NEMA Type 1 (without EMC filter)

Single-phase, 200 VAC

Model CIMR-VC□	A	B	C	kg
BA0001F	68	149.5	76	0.8
BA0002F	68	149.5	76	0.8
BA0003F	68	149.5	118	1.2
BA0006F	108	149.5	137.5	1.9
BA0010F	108	149.5	154	2.0
BA0012F	140	153	163	2.6
BA0018F	170	171	180	3.3

Three-phase, 200 VAC

Model CIMR-VC□	A	B	C	kg
2A0001F	68	149.5	76	0.8
2A0002F	68	149.5	76	0.8
2A0004F	68	149.5	108	1.1
2A0006F	68	149.5	128	1.3
2A0010F	108	149.5	129	1.9
2A0012F	108	149.5	137.5	1.9
2A0020F	140	153	143	2.6
2A0030F	140	254	140	3.8
2A0040F	140	254	140	3.8
2A0056F	180	290	163	5.5
2A0069F	220	350	187	9.2

Three-phase, 400 VAC

Model CIMR-VC□	A	B	C	kg
4A0001F	108	149.5	81	1.2
4A0002F	108	149.5	99	1.4
4A0004F	108	149.5	137.5	1.9
4A0005F	108	149.5	154	1.9
4A0007F	108	149.5	154	1.9
4A0009F	108	149.5	154	1.9
4A0011F	140	153	143	2.6
4A0018F	140	254	140	3.8
4A0023F	140	254	140	3.8
4A0031F	180	290	143	5.2
4A0038F	180	290	163	5.5

Cold plate

Single-phase, 200 VAC

Model CIMR-VC□	A	B	C	kg
BA0001J	68	128	71	0.6
BA0002J	68	128	71	0.6
BA0003J	68	128	81	0.8
BA0006J	108	128	79.5	1.1
BA0010J	108	128	91	1.1
BA0012J	140	128	98	1.4

Three-phase, 200 VAC

Model CIMR-VC□	A	B	C	kg
2A0001J	68	128	71	0.6
2A0002J	68	128	71	0.6
2A0004J	68	128	71	0.7
2A0006J	68	128	71	0.7
2A0008J	108	128	71	1.0
2A0010J	108	128	71	1.0
2A0012J	108	128	79.5	1.0
2A0018J	140	128	78	1.3
2A0020J	140	128	78	1.3
2A0030J	140	260	145	3.2
2A0040J	140	260	145	3.2
2A0056J	180	300	147	4.6
2A0069J	220	350	152	7.0

Three-phase, 400 VAC

Model CIMR-VC□	A	B	C	kg
4A0001J	108	128	71	0.9
4A0002J	108	128	71	0.9
4A0004J	108	128	79.5	1.0
4A0005J	108	128	96	1.0
4A0007J	108	128	96	1.1
4A0009J	108	128	96	1.1
4A0011J	140	128	78	1.3
4A0018J	140	260	145	3.1
4A0023J	140	260	145	3.2
4A0031J	180	300	147	4.3
4A0038J	180	300	147	4.6

IP66

Single-phase, 200 VAC





Model CIMR-VC□	A	B	C	kg
BA0001H	262	340	173.5	4.9
BA0002H	262	340	173.5	4.9
BA0003H	262	340	173.5	5.1
BA0006H	262	340	173.5	5.7
BA0010H	262	340	173.5	5.8
BA0012H	262	340	173.5	6.1

Three-phase, 400 VAC

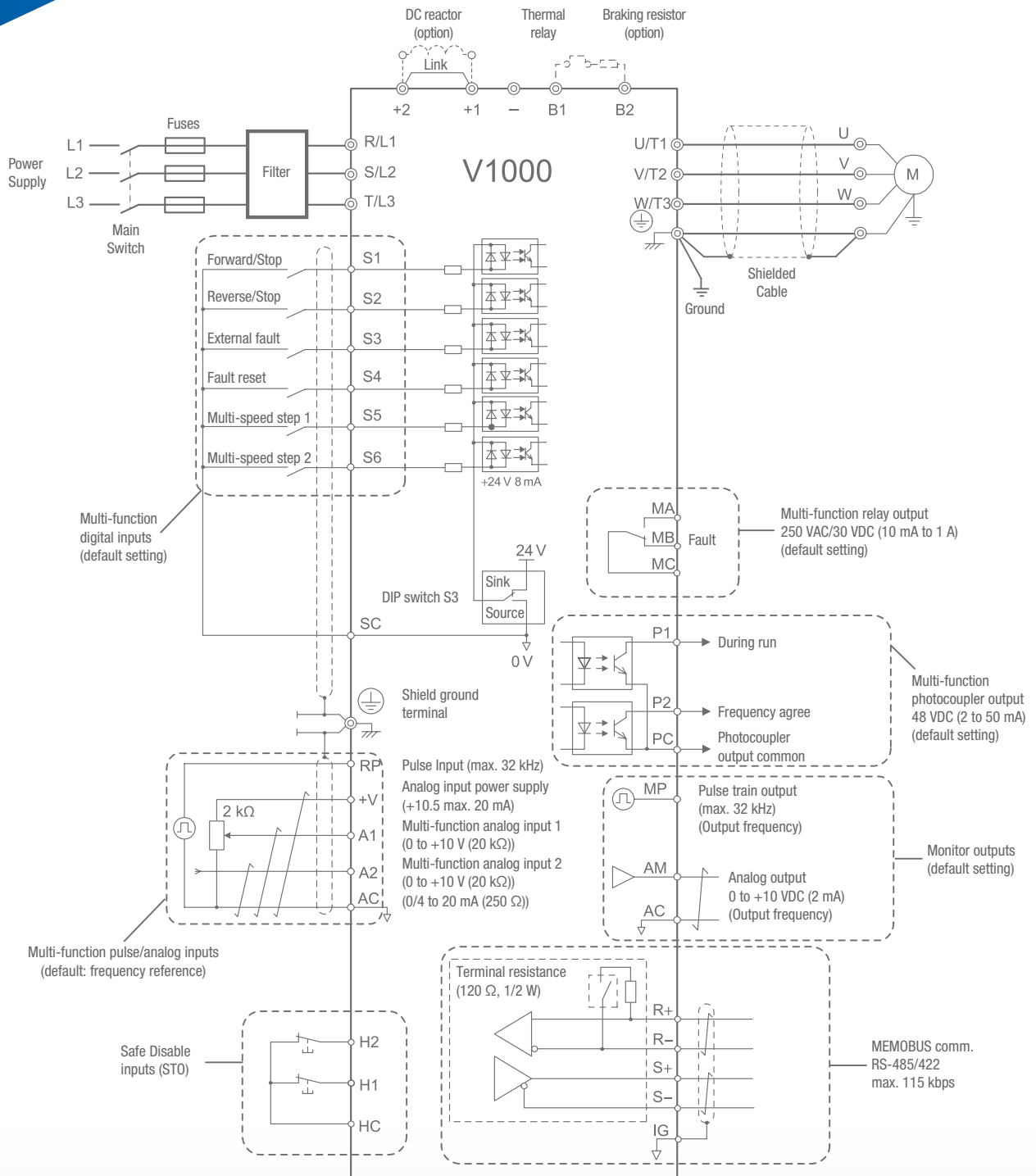
Model CIMR-VC□	A	B	C	kg
4A0001H	262	340	173.5	5.2
4A0002H	262	340	173.5	5.2
4A0004H	262	340	173.5	5.3
4A0005H	262	340	173.5	5.3
4A0007H	262	340	173.5	5.7
4A0009H	262	340	173.5	5.7
4A0011H	262	340	173.5	6.0
4A0018H	345	500.5	273.5	19.8
4A0023H	345	500.5	273.5	19.9
4A0031H	345	500.5	273.5	21.0
4A0038H	345	500.5	273.5	21.3









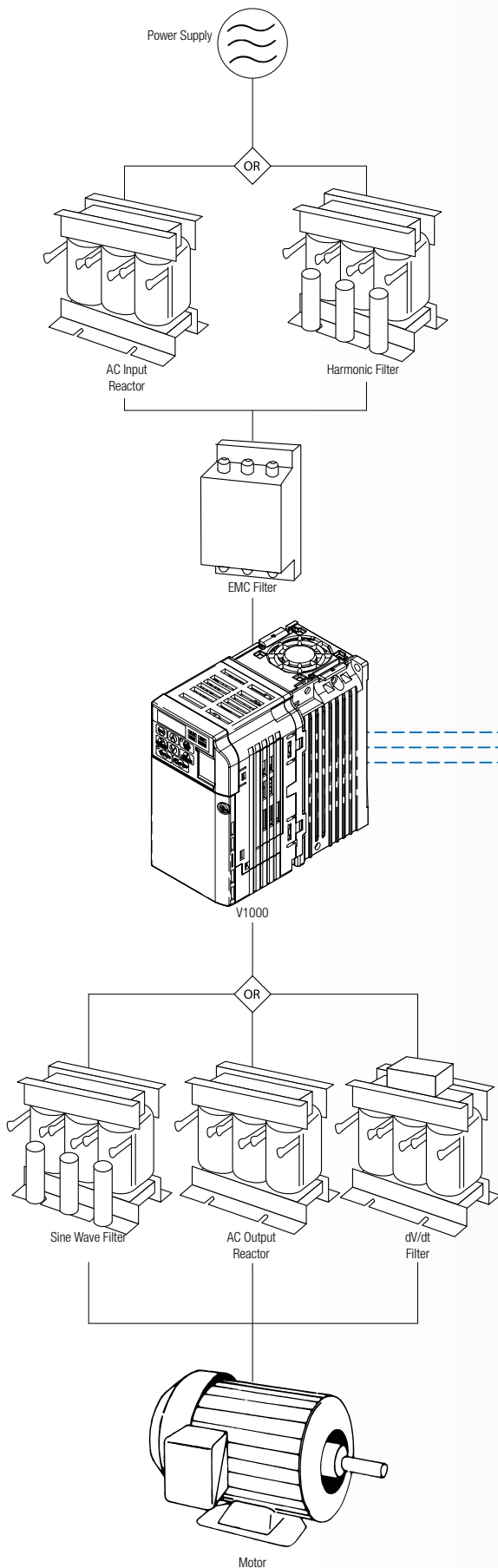

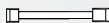
Connection diagram



-  Use twisted pair cables
-  Use shielded twisted pair cables
-  Indicates a main circuit terminal
-  Indicates a control circuit terminal

Options



-  RJ-45/USB Adapter
-  USB Cable
-  DriveWizard Plus DriveWorks EZ
-  Remote Operator Extension Cable
-  LCD Remote Operator
-  Remote Operator Monitor Frame
-  24 VDC Control Board Power Supply
-  Communication Option Board
-  DIN Rail Kit
-  Braking Resistor
-  Heatsink Outside Mounting Kit

Name	Purpose
AC input reactor	This reactor type is used to suppress harmonic currents and to improve the total power factor. It also can protect the input rectifier from sudden variations of power supply conditions.
Harmonic filter	Provide sinusoidal input current helping to comply with power quality standards like IEEE519 or EN61000-3-12. Furthermore harmonic filters reduce the electrical and thermal burden on the power supply infrastructure.
EMC line filter	Suppresses the high frequency noise generated by the AC drive. The EMC line filter should be installed as close as possible to the drive.
Communication interface unit	Allows control of the drive via a fieldbus network.
LCD operator	LCD full text display (13 languages) for quick and easy setup and parameter management incl. parameter copy function
LED operator	LED digital operator for easier programming.
Operator extension cable	Cable for connecting the LCD operator.
Operator mounting frame	IP65 mounting frame for JVOP-180/182 on panel door or wall
USB copy unit (RJ-45/USB compatible plug)	Adapter for connecting the V1000 to the USB port of a PC (e.g. for support tool DriveWizard Plus), and for transferring parameter settings to another V1000
24 V power supply	Provides power supply for the control circuit and option boards. Note: Parameter settings cannot be changed when the drive is operating solely from this power supply.
Attachment for external heatsink	Mechanical kit to install the drive with the heatsink outside of the cabinet.
DIN rail attachment kit	Mechanical kit for installation on a DIN rail.
Braking resistor	Use to shorten the deceleration time by dissipating regenerative energy through a resistor.
Sine wave output filter	This filter type smoothens the drive output voltage and suppresses differential mode interference, thus improving motor service life and EMC environment. Recommended also for very long, unshielded motor cables.
dV/dt filter	Limits the output voltage rise at drive output to protect motor insulation.
AC output reactor	Limit voltage peaks at the motor winding, especially with long motor cables, thus improving the motor service life.



Accessories

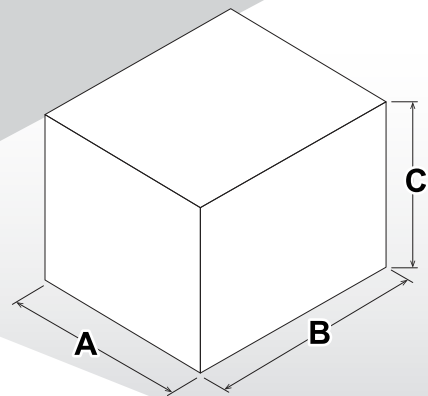

EMC filter

V1000, 400 V class

AC Drive Model	EMC filter (IP00) Model Code	A	B	C	kg
CIMR-VC4A0001xAA	FS23639-5-07	111	169	45	0.5
CIMR-VC4A0002xAA					
CIMR-VC4A0004xAA					
CIMR-VC4A0005xAA	FS23639-10-07	111	169	45	0.7
CIMR-VC4A0007xAA					
CIMR-VC4A0009xAA	FS23639-15-07	144	174	50	0.9
CIMR-VC4A0011xAA	FS23639-30-07	137	264	56	1.8
CIMR-VC4A0018xAA					
CIMR-VC4A0023xAA	FS23639-50-07	175	300	65	2.7
CIMR-VC4A0031xAA					
CIMR-VC4A0038xAA					

V1000, 200 V class, 3 phase

AC Drive Model	EMC filter (IP00) Model Code	A	B	C	kg
CIMR-VC2A0001BAA	FS23637-8-07	71	169	40	0.4
CIMR-VC2A0002BAA					
CIMR-VC2A0004BAA					
CIMR-VC2A0006BAA					
CIMR-VC2A0010BAA	FS23637-14-07	111	169	45	0.58
CIMR-VC2A0012BAA					
CIMR-VC2A0020BAA	FS23637-24-07	144	174	50	0.9
CIMR-VC2A0030FAA	FS23637-52-07	137	264	56	2
CIMR-VC2A0040FAA					
CIMR-VC2A0056FAA	FS23637-68-07	175	300	65	2.6
CIMR-VC2A0069FAA	FS23637-80-07	212	353	65	3.1

V1000, 200 V class, 1 phase

AC Drive Model	EMC filter (IP00) Model Code	A	B	C	kg
CIMR-VCBA0001BAA	FS23638-10-07	71	169	45	0.44
CIMR-VCBA0002BAA					
CIMR-VCBA0003BAA					
CIMR-VCBA0006BAA	FS23638-20-07	111	169	50	0.8
CIMR-VCBA0010BAA					
CIMR-VCBA0012BAA	FS23638-30-07	144	174	50	1.2
CIMR-VCBA0018BAA	FS23638-40-07	174	174	50	1.6





AC input reactors

2% Input Impedance

AC Drive Model	AC input reactor 2% (IP00) Model Code	A	B	C	kg	IP20 box Model code	A	B	C	kg
CIMR-VC4A0001xAA	ALR3 40-2/2	78	54	87	0.5	IP20-Box31	220	130	170	0.9
CIMR-VC4A0002xAA										
CIMR-VC4A0004xAA	ALR3 40-2/4	78	54	87	0.5	IP20-Box31	220	130	170	0.9
CIMR-VC4A0005xAA	ALR3 40-2/6	78	64	87	1.1					
CIMR-VC4A0007xAA	ALR3 40-2/10	96	76	107	1.5	IP20-Box31	220	130	170	0.9
CIMR-VC4A0009xAA										
CIMR-VC4A0011xAA	ALR3 40-2/16	127	76	125	2	IP20-Box32	220	155	190	1.25
CIMR-VC4A0018xAA	ALR3 40-2/20	127	76	125	2					
CIMR-VC4A0023xAA	ALR3 40-2/25	127	89	125	2.9	IP20-Box32	220	155	190	1.25
CIMR-VC4A0031xAA	ALR3 40-2/45	152	102	163	3.8					
CIMR-VC4A0038xAA										

4% Input Impedance

AC Drive Model	AC input reactor 4% (IP00) Model Code	A	B	C	kg	IP20 box Model code	A	B	C	kg
CIMR-VC4A0001xAA	LR3 40-4/2	78	56	100	0.55	IP20-Box31	220	130	170	0.9
CIMR-VC4A0002xAA										
CIMR-VC4A0004xAA	LR3 40-4/4	96	60	117	1.3	IP20-Box32	220	155	190	1.25
CIMR-VC4A0005xAA	LR3 40-4/6	96	69	117	1.45					
CIMR-VC4A0007xAA	LR3 40-4/10	120	85	140	2	IP20-Box32	220	155	190	1.25
CIMR-VC4A0009xAA										
CIMR-VC4A0011xAA	LR3 40-4/16	120	95	140	2.7	IP20-Box32	220	155	190	1.25
CIMR-VC4A0018xAA	LR3 40-4/20	155	95	162	3.8					
CIMR-VC4A0023xAA	LR3 40-4/25	155	110	177	5.8	IP20-Box33	340	170	205	1.5
CIMR-VC4A0031xAA	LR3 40-4/45	185	112	210	8.25	IP20-Box35	310	145	225	1.45
CIMR-VC4A0038xAA										



Harmonic filters

Total Harmonic Distortion THD-I < 5%

AC Drive Model	Harmonic filter (IP00) Model Code	A	B	C	kg
CIMR-VC4A0001xAA	HFM-FB 7-400	165	455	242	27
CIMR-VC4A0002xAA					
CIMR-VC4A0004xAA					
CIMR-VC4A0005xAA					
CIMR-VC4A0007xAA					
CIMR-VC4A0009xAA					
CIMR-VC4A0011xAA	HFM-FB 13-400	165	445	242	28
CIMR-VC4A0018xAA					
CIMR-VC4A0023xAA	HFM-FB 18-400	365.5	645	225	40
CIMR-VC4A0031xAA	HFM-FB 30-400	365.5	885	225	52
CIMR-VC4A0038xAA					

Digital operator

Practical keypad, usable for remote operation.
Built-in parameter copy function.
For cabinet door mounting use JVOP-V11001

5 digit, 8 segment LED operator JVOP-182:

- Good readability from distance and in dark environment

Full text LCD keypad JVOP-180:

- Up to 13 languages



JVOP-180



JVOP-182

Copy unit/ USB converter

Handy copy unit for drive parameters.

- Copy/verify parameter settings between drives easily
- Usable as USB converter for connection to a PC
- Memorize parameter settings, archive them on a PC later



JVOP-181

Communication option cards

Communication option cards connect a drive to a network. Using this option unit a master device can:

- Operate the drive
- Monitor the drive operation status
- Read or modify drive parameters

Model Code	Communication Option Type
SI-S3/V	CANopen
SI-N3/V	DeviceNet
SI-P3/V	PROFIBUS-DP
SI-C3/V	CC-Link
SI-T3/V	MECHATROLINK II
SI-ET3/V	MECHATROLINK III
SI-EN3/V	Ethernet-IP
SI-EN3D/V	Dual-port Ethernet-IP
SI-EM3/V	Modbus TCP/IP
SI-EP3/V	PROFINET
SI-ES3/V	EtherCAT
SI-EL3/V	Powerlink

Mechanical options

For harsher environments the protection level of the AC drive can be improved by using mechanical options like mounting frames. They also provide more options for mounting an AC drive, e.g. DIN rails and Heatsink External Mounting Kits.

Model Code	Description
EZZ020568::	Installation kit for mounting the AC drive with the heatsink outside of the panel (Side-by-Side mounting possible)
EUOP-V11001	Frame for mounting JVOP-180/182 on panel door or wall, IP65
EZZ08122::	Mechanical kit for mounting an AC drive on a DIN rail

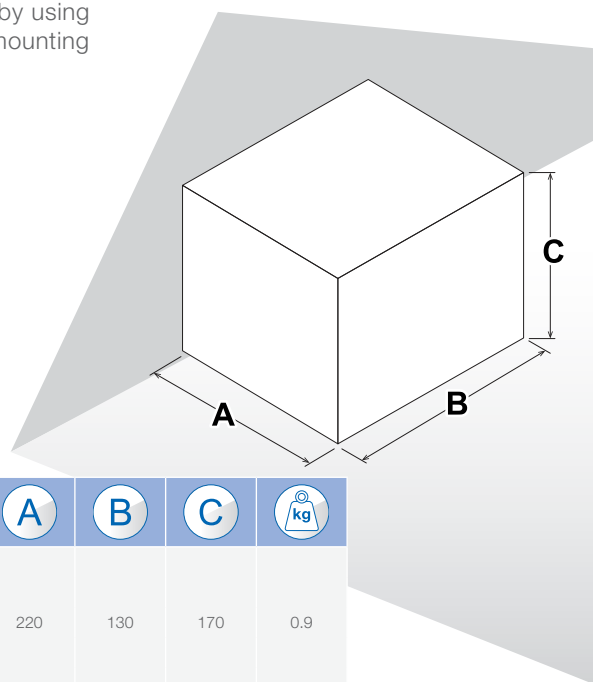

dV/dt filter

AC Drive Model	dV/dt filter (IP00) Model Code	A	B	C		IP20 box Model code	A	B	C	
CIMR-VC4A0001xAA	DB-40007A-IP00	100	95	170	1.7	IP20-Box31	220	130	170	0.9
CIMR-VC4A0002xAA										
CIMR-VC4A0004xAA										
CIMR-VC4A0005xAA										
CIMR-VC4A0007xAA										
CIMR-VC4A0009xAA	DB-40024A-IP00	145	75	210	4.4	IP20-Box32	220	155	190	1.25
CIMR-VC4A0011xAA										
CIMR-VC4A0018xAA										
CIMR-VC4A0023xAA	DB-40045A-IP00	185	102	200	8.0	IP20-Box35	310	145	225	1.45
CIMR-VC4A0031xAA										
CIMR-VC4A0038xAA										

AC output reactors

Max. output frequency: 50 Hz

AC Drive Model	AC output reactors (IP00) Model Code	A	B	C	kg	IP20 box Model code	A	B	C	kg
CIMR-VC4A0001xAA	MR3 400/4	77	63	101	0,9	IP20-Box31	220	130	170	0.9
CIMR-VC4A0002xAA										
CIMR-VC4A0004xAA										
CIMR-VC4A0005xAA	MR3 400/10	240	170	273	1,8	IP20-Box32	220	155	190	1.25
CIMR-VC4A0007xAA										
CIMR-VC4A0009xAA										
CIMR-VC4A0011xAA	MR3 400/18	240	190	275	2,1	IP20-Box33*	340	170	205	1.5
CIMR-VC4A0018xAA	MR3 400/24	120	95	142	2,2					
CIMR-VC4A0023xAA*	MR3 400/37	310	190	335	3,6					
CIMR-VC4A0031xAA	MR3 400/48	185	100	211	6,5	IP20-Box35	310	145	225	1.45
CIMR-VC4A0038xAA										

* when using 8 kHz choose MR3 400/37. Otherwise choose MR3 400/24, and IP20-Box32.

Max. output frequency: 120 Hz

AC Drive Model	AC output reactors (IP00) Model Code	A	B	C	kg	IP20 box Model code	A	B	C	kg
CIMR-VC4A0001xAA	MDB 400/6,3	155	70	160	4,5	IP20-Box31	220	130	170	0.9
CIMR-VC4A0002xAA										
CIMR-VC4A0004xAA										
CIMR-VC4A0005xAA	MDB 400/13	155	85	160	5,5	IP20-Box32	220	155	190	1.25
CIMR-VC4A0007xAA										
CIMR-VC4A0011xAA										
CIMR-VC4A0018xAA	MDB 400/24	190	115	193	10	IP20-Box36	335	165	240	1.75
CIMR-VC4A0023xAA*										
CIMR-VC4A0031xAA	MDB 400/46	210	120	182	10,3	IP20-Box37	335	175	240	1.8
CIMR-VC4A0038xAA										

* when using 8 kHz choose MDB 400/46 and IP20-Box37.

Sine filter

AC Drive Model	Sine filter (IP00) Model Code	A	B	C	kg	IP20 box Model code	A	B	C	kg
CIMR-VC4A0001xAA	SR-40004A-00	125	61	167	2.4	IP20-Box06	240	182	220	2.5
CIMR-VC4A0002xAA										
CIMR-VC4A0004xAA										
CIMR-VC4A0005xAA	SR-40006A-00	125	72	175	2.9	IP20-Box07	290	232	255	3.5
CIMR-VC4A0007xAA										
CIMR-VC4A0009xAA										
CIMR-VC4A0010xAA	SR-40010A-00	155	77	205	4.6	IP20-Box08	340	302	320	5.0
CIMR-VC4A0011xAA										
CIMR-VC4A0016xAA	SR-40016A-00	190	82	235	8.0	IP20-Box08	340	302	320	5.0
CIMR-VC4A0018xAA										
CIMR-VC4A0020xAA	SR-40020A-00	190	125	215	9.3	IP20-Box08	340	302	320	5.0
CIMR-VC4A0023xAA*										
CIMR-VC4A0024xAA	SR-40024A-00	190	135	215	11.0	IP20-Box08	340	302	320	5.0
CIMR-VC4A0031xAA										
CIMR-VC4A0037AA	SR-40037A-00	240	160	275	20.5	IP20-Box08	340	302	320	5.0
CIMR-VC4A0038AA										
CIMR-VC4A0038AA	SR-40048A-00	240	170	285	22.0	IP20-Box08	340	302	320	5.0

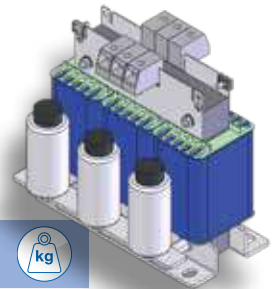

Application Notes

Drive duty modes

YASKAWA AC drives have two duty modes from which a customer can select the application: Heavy Duty (HD) or Normal Duty (ND).

Duty mode*	Application	Inverter overload capability
Heavy duty	Constant torque or high starting torque <ul style="list-style-type: none">• Extruder• Mixer• Compressor• Conveyor• Crusher• Mill• Hoist	150% rated inverter output current for 60 seconds
Normal duty	Variable (square) torque <ul style="list-style-type: none">• Fan• Pump• Blower	120% rated inverter output current for 60 seconds

* Differences between HD ratings and ND ratings for the drive include rated input and output current, overload capacity, carrier frequency and current limit.

Peripheral devices

Magnetic contactor for input power

Use a magnetic contactor (MC) to ensure that power to the drive can be completely shut off when necessary.

Even though an MC is designed to switch following a momentary power loss, frequent MC use can damage components in the drive. Avoid switching the MC more than once every 30 minutes.

Magnetic contactor for motor

As a general principle, the user should avoid opening and closing the magnetic contactor during run. Doing so can cause high peak currents and overcurrent faults. If magnetic contactors are used to bypass the drive by connecting the motor to the power supply directly, make sure to close the bypass only after the drive is stopped and fully disconnected from the motor.

Improving the power factor

Installing a DC or AC reactor to the input side of the drive can help improve the power factor.

Selection

Drive Capacity

When running multiple induction motors in parallel using a single drive, the capacity of the drive should be larger than 1.1 times the total motor rated current. Use V/f control when running multiple induction motors using a single drive.

Starting Torque

The overload current rating of the drive determines the starting and acceleration characteristics of the motor. Generally, lower torque characteristics on starting are expected when compared to using a commercial power supply. For applications that require high starting torque, select an drive with a larger capacity.

Emergency Stop

When the drive faults out, a protective function is activated and drive output is shut off. This does not stop the motor immediately. Some type of mechanical brake may be needed if it is necessary to stop the motor faster than the Fast Stop function is able to do.

Settings

Upper Limits

The drive is capable to run the motor up to 400 Hz. Incorrect settings might result in dangerous operating conditions, so be sure to set the upper limit for the frequency to control the maximum speed. (The maximum output frequency for operation by external input signals is set to 50 Hz by default.)

Accel/Decel Times

Accel and decel times are determined by the torque that the motor generates, the load torque and the inertia moment (GD²). When the stall prevention function is activated, the accel/decel time might be extended to ensure motor control and prevents the motor from stalling. To achieve even faster acceleration and deceleration, select motors, and a drive, with greater capacity.

General Handling

Compliance with local laws

Please comply with the law of the relevant country when you install this product.

Ambient Environment

Keep the drive in a clean environment that is free from airborne oil mist, corrosive gas, flammable gas, lint and dust.

Wiring Check

Never short the output terminals of the drive or apply voltage from the power supply to the output terminals (U, V, W). This will damage the drive. Carry out wiring that conforms to the wire sizes and tightening torques described in the Technical Manual. Make a wiring check to prevent wiring errors before turning the power on.

Inspection and Maintenance

Even after shutting off the drive, it takes some time to discharge of internal capacitors. Make sure that the CHARGE light has gone off completely before performing any inspection or maintenance work. The heatsink of the drive can become quite hot during operation, and proper precautions should be taken to prevent burns. When replacing the cooling fan, shut off the power supply to the drive and wait at least 15 minutes before replacing the cooling fan.

Insulation Tolerance

Consider voltage tolerance levels and insulation in applications with high input voltage or particularly long wiring distances.

High Speed Operation

Running a motor beyond its rated speed may lead to problems imposed by vibration or the durability of motor bearings. Contact the manufacturer of the motor for details.

YASKAWA Europe GmbH

Drives Motion Controls Division
Hauptstr. 185
65760 Eschborn
Germany

+49 6196 569-500
support@yaskawa.eu.com
www.yaskawa.eu.com

06/2018
YEU_INV_V1000_EN_v8

Specifications are subject to change without notice for ongoing product modifications and improvements. © YASKAWA Europe GmbH. All rights reserved.

YASKAWA