

- According to
 - Performance Level (PL) e and category 4 to EN ISO 13849-1: 2008
 - SIL Claimed Level (SIL CL) 3 to IEC/EN 62061
 - Safety Integrity Level (SIL) 3 to IEC/EN 61508
- when connected to a suitable safety module
- Redundant and forcibly guided contacts
- Output: 7 NO contacts, 1 NC contact for feed back circuit
- 1- or 2-channel connection
- LED displays for channels 1.2
- Removable terminal strips
- Width 100 mm

Block Diagram

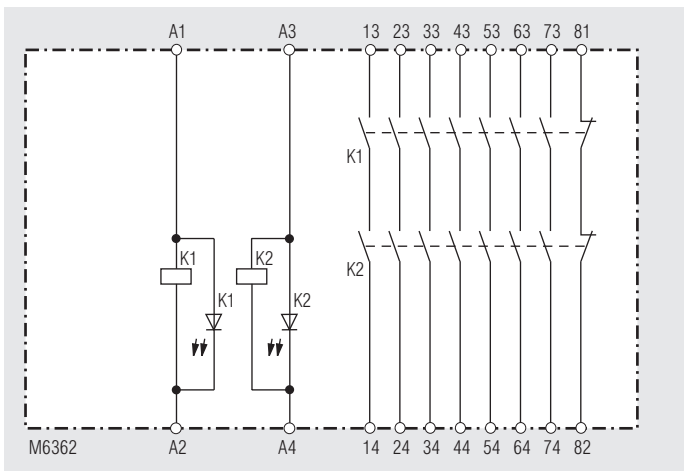

Approvals and Marking



* see variants

Applications

Contact multiplication of e-stop modules and safety door monitors.

Indication

LED K1: on when supply on relay K1
LED K2: on when supply on relay K2

Notes

The extension module BN 3081 must only be used together with a safety unit e.g. LG 5925) that monitors the feedback circuit 81/82 to achieve (SIL CL) 3 acc. to IEC/EN 62061, SIL 3 to IEC/EN 61508, Performance Level (PL) e and Category 4 to EN ISO 13849-1: 2008.

Circuit Diagram

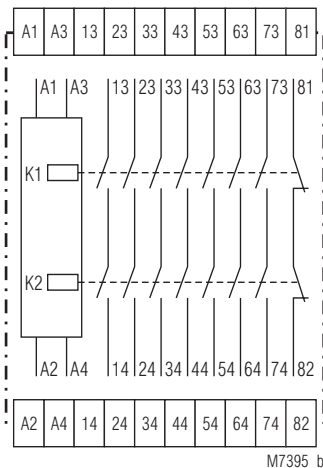

Connection Terminals

Terminal designation	Signal designation
A1 (+), A3 (+)	+ / L
A2, A4	- / N
13, 14, 23, 24, 33, 34, 43, 44, 53, 54, 63, 64, 73, 74	Forcibly guided NO contacts for release circuit
81, 82	Forcibly guided feedback circuit

Technical Data**Input**

Nominal voltage U_N:	AC 110, 115, 120, 230 V; DC 110 V AC/DC 24, 48 V For extension modules where the nominal voltage is the mains voltage EN 60204 part 9.1.1 must be fulfilled
Voltage range:	AC 0.8 ... 1.1 U_N DC 0.9 ... 1.2 U_N
at 10% residual ripple:	DC 0.8 ... 1.1 U_N
at 48% residual ripple:	DC 0.8 ... 1.1 U_N
Nominal consumption:	5.5 VA; 2.8 W
Nominal frequency:	50 / 60 Hz
Control current:	approx. 12 mA for K1 and K2 at AC 230 V approx. 55 mA for K1 and K2 at DC 24 V

Output

Contacts	
BN 3081.63:	7 NO contacts, 1 NC contact for feed back circuit

The NO contacts are safety contacts.

ATTENTION! The NC contacts 81-82 can only be used for monitoring.

Response / release time of

K1 and K2:	35 ms / 35 ms
Contact type:	Relay, forcibly guided
Nominal output voltage:	AC 400 V / DC 230 V
Thermal current I_{th}:	see Limit curve for arc-free operation (max. 10 A in one contact path)

Switching capacity

to AC 15	
NO contact:	5 A / AC 230 V IEC/EN 60 947-5-1
to DC 13	
NO contact:	2 A / DC 24 V IEC/EN 60 947-5-1
to DC 13	
NO contact:	6 A / DC 24 V at 0.1 Hz

Electrical life

to AC 15 at 2 A, AC 230 V:	10 ⁵ switching cycles IEC/EN 60 947-5-1
----------------------------	--

Permissible operating frequency:

6000 switching cycles / h

Short circuit strength

max. fuse rating:	10 A gL IEC/EN 60 947-5-1
max. automatic fuse:	C10A

Mechanical life:

10 x 10⁶ switching cycles

General Data

Operating mode: Continuous operation

Temperature range

operation:	- 15 ... + 55 °C at max. 90 % humidity
storage :	- 25 ... + 85 °C
altitude:	< 2.000 m

Clearance and creepage distances

rated impuls voltage / pollution degree:	4 kV / 2 (basis insulation) IEC 60 664-1
---	--

EMC

Electrostatic discharge:	8 kV (air) IEC/EN 61 000-4-2
HF irradiation:	10 V / m IEC/EN 61 000-4-3
Fast transients:	2 kV IEC/EN 61 000-4-4

Surge voltages

between wires for power supply:	2 kV IEC/EN 61 000-4-5
between wire and ground:	4 kV IEC/EN 61 000-4-5
Interference suppression:	Limit value class B EN 55 011

Degree of protection

Housing:	IP 40 IEC/EN 60 529
Terminals:	IP 20 IEC/EN 60 529

Housing: Thermoplastic with V0 behaviour according to UL subject 94

Vibration resistance: Amplitude 0.35 mm IEC/EN 60 068-2-6
frequency 10 ... 55 Hz

Technical Data

Climate resistance:	15 / 055 / 04 IEC/EN 60 068-1
Terminal designation:	EN 50 005
Wire connection:	2 x 2.5 mm ² solid or 2 x 1.5 mm ² stranded ferruled DIN 46 228-1/-2/-3/-4
Wire fixing:	Flat terminals with self-lifting clamping piece IEC/EN 60 999-1 Terminal strip removable
Mounting:	DIN rail DIN/EN 60 715
Weight:	510 g

Dimensions

Width x height x depth: 100 x 74 x 121 mm

Safety Related Data**Values according to EN ISO 13849-1:**

Category:	4	
PL:	e	
MTTF _d :	103,1	a
DC / DC _{avg} :	99.0	%
d _{op} :	365	d/a (days/year)
h _{op} :	24	h/d (hours/day)
t _{Zyklus} :	2.60E+06	s/Zyklus
	≈ 1	/mth (month)

Values according to IEC/EN 62061 / IEC/EN 61508:

SIL CL:	3 IEC/EN 62061
SIL	3 IEC/EN 61508
HFT:	1
DC / DC _{avg} :	99.0 %
SFF	99.7 %
PFH _D :	6.65E-10 h ⁻¹
T ₁ :	20 a (year)

*) HFT = Hardware-Failure Tolerance



The values stated above are valid for the standard type. Safety data for other variants are available on request.

The safety relevant data of the complete system has to be determined by the manufacturer of the system.

UL-Data

The safety functions were not evaluated by UL. Listing is accomplished according to requirements of Standard UL 508, "general use applications"

Switching capacity:

NO contact: Pilot duty B300
10A 250Vac G.P.
10A 24Vdc

NC contact: 10A 250Vac G.P.
10A 24Vdc

Wire connection: 60°C / 75°C copper conductors only
AWG 16 - 14 Torque 0.8 Nm



Technical data that is not stated in the UL-Data, can be found in the technical data section.

CCC-Data

Thermal current I_{th} : see quadratic total current limit curve
(max. 5 A in one contact path)



Technical data that is not stated in the CCC-Data, can be found in the technical data section.

Standard Type

BN 3081.63 AC/DC 24 V

Article number: 0044207

- Output: 7 NO contacts, 1 NC contact for feed back circuit
- Nominal voltage U_N : AC/DC 24 V
- Width: 100 mm

Variant

BN 3081.63/61: with UL-approval

Ordering example for variant

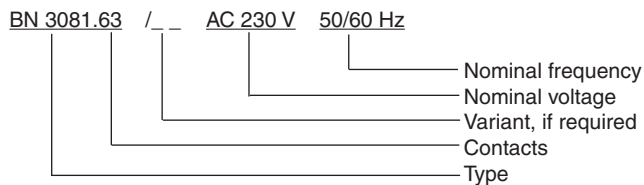

Characteristics

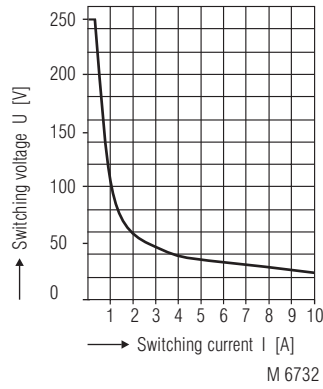
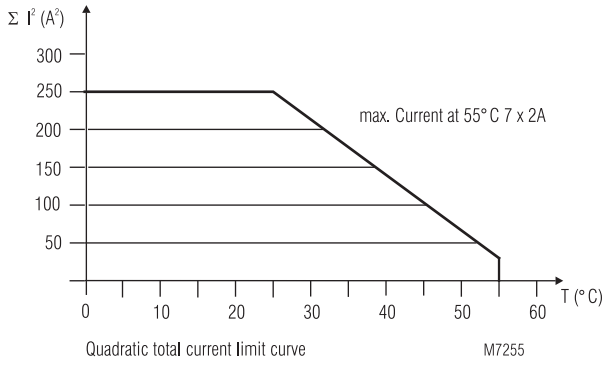

Quadratic total current limit curve

Limit curve for arc-free operation for resistive load

Application Examples

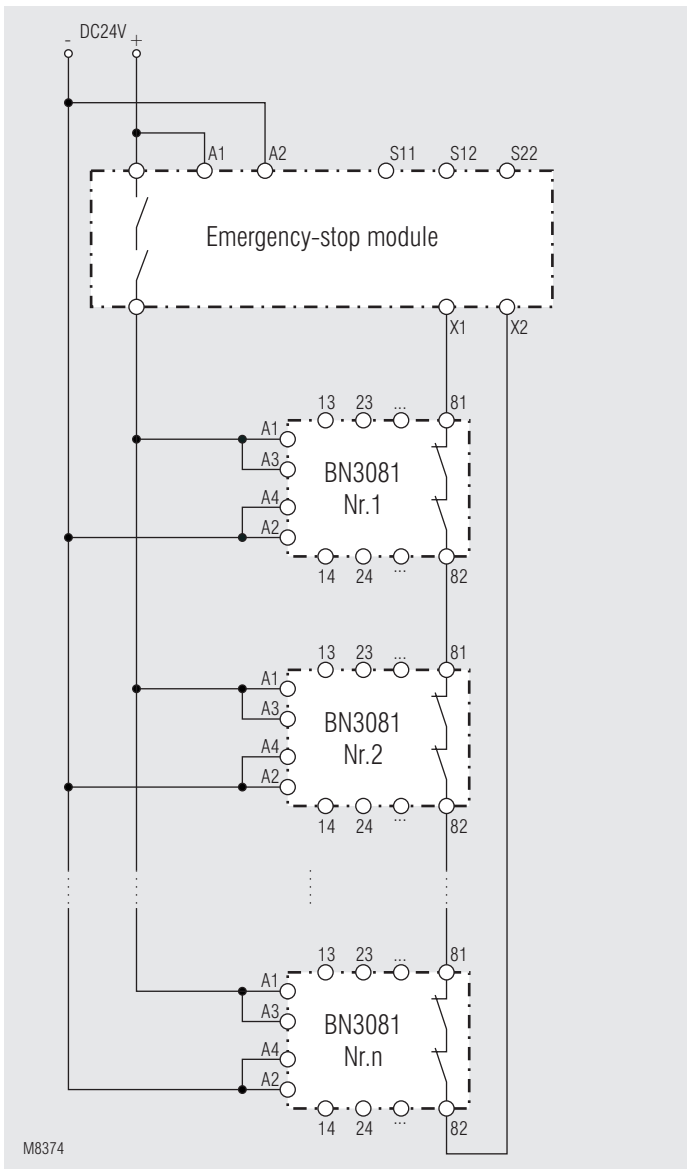

Contact multiplication with several extension modules 1-channel; suitable up to SIL3, Performance Level e, Cat. 4

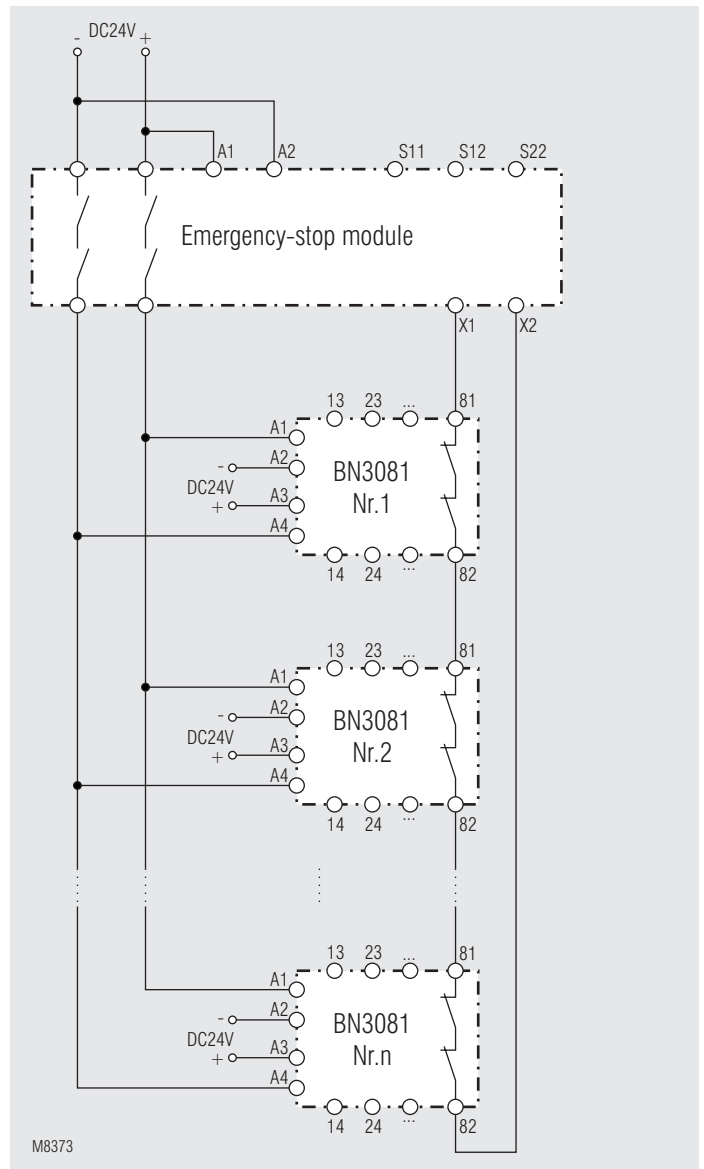

Contact multiplication with several extension modules 2-channel with cross fault monitoring; suitable up to SIL3, Performance Level e, Cat. 4