

WEU26/2-132

WSU/WEU26/2

SINGLE-BEAM PHOTOELECTRIC SAFETY SWITCHES

SICK
Sensor Intelligence.

Ordering information

Type	Part no.
WEU26/2-132	1015728

Other models and accessories → www.sick.com/WSU_WEU26_2



Detailed technical data

Safety-related parameters

Type	EN 61496 part 1 and EN 50100 part 2
-------------	-------------------------------------

Features

Number of beams	1
Response time	≤ 22 ms
Front screen heating	✓
Synchronization	Optical, without separate synchronization cable

Interfaces

Connection type	Plug 6 + PE
Diagnostic display	LED
Fieldbus, industrial network Integration via Flexi Soft safety controller	CANopen, DeviceNet™, EtherCAT®, EtherNet/IP™, Modbus TCP, PROFIBUS DP, PROFINET ¹⁾

¹⁾ For further information on Flexi Soft, please see sens:Control – safe control solutions product catalog or -> www.sick.com/FlexiSoft.

Electrical data

Switching outputs	Switching outputs
Switching current	0.02 A ... 2 A
Electrical life (relay contacts)	8 x 10 ⁴ switching cycles

Ambient data

Enclosure rating	IP65
Ambient operating temperature	-25 °C ... +55 °C
Storage temperature	-25 °C ... +70 °C
Air humidity	15 % ... 95 %, Non-condensing
Vibration resistance	5 g, 10 Hz ... 55 Hz (IEC 68-2-6)
Shock resistance	10 g (according to IEC 68-2-29)

Classifications

ECl@ss 5.0	27272701
ECl@ss 5.1.4	27272701
ECl@ss 6.0	27272701
ECl@ss 6.2	27272701
ECl@ss 7.0	27272701
ECl@ss 8.0	27272701

ECI@ss 8.1	27272701
ECI@ss 9.0	27272701
ETIM 5.0	EC001831
ETIM 6.0	EC001831
UNSPSC 16.0901	46171620

Dimensional drawing (Dimensions in mm (inch))

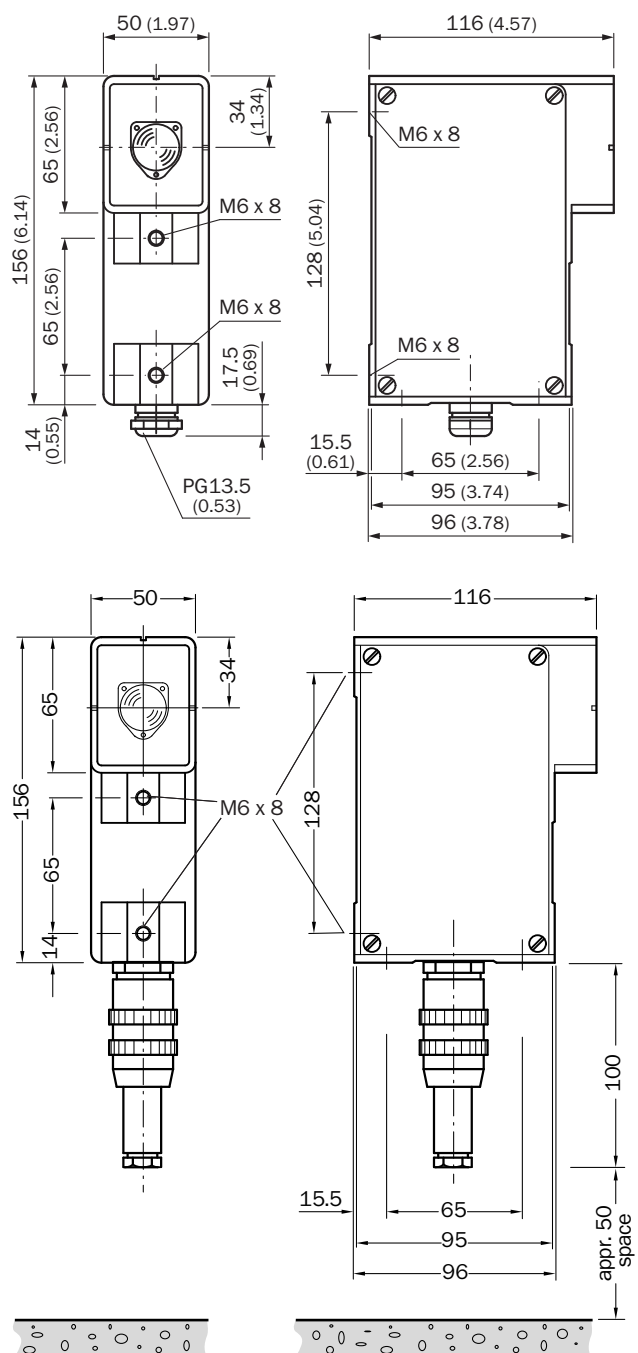

WEU26/2-132 | WSU/WEU26/2

SINGLE-BEAM PHOTOELECTRIC SAFETY SWITCHES



SICK AT A GLANCE

SICK is one of the leading manufacturers of intelligent sensors and sensor solutions for industrial applications. A unique range of products and services creates the perfect basis for controlling processes securely and efficiently, protecting individuals from accidents and preventing damage to the environment.

We have extensive experience in a wide range of industries and understand their processes and requirements. With intelligent sensors, we can deliver exactly what our customers need. In application centers in Europe, Asia and North America, system solutions are tested and optimized in accordance with customer specifications. All this makes us a reliable supplier and development partner.

Comprehensive services complete our offering: SICK LifeTime Services provide support throughout the machine life cycle and ensure safety and productivity.

For us, that is “Sensor Intelligence.”

WORLDWIDE PRESENCE:

Contacts and other locations –www.sick.com