



**DX line**  
**Installation  
manual**

ISO 9001  
Certified

**DX line**

Installation manual • M.I. DX-2/08.04 • Cod. J30-658-1ADX IE



**Table of contents**

- General description
- Model code
- Electric safety
- Installation kit
- Installation
- Removing/inserting the module in its housing
- Electrical connections
- Communications buses terminations
- DIP switches setting
- Module status and service LEDs

**Ascon Tecnologic S.r.l.**

via Indipendenza 56,  
27029 - Vigevano (PV) - ITALY  
Tel.: +39 0381 69871, Fax: +39 0381 698730  
internet site: www.ascontecnologic.com  
E-mail: sales@ascontecnologic.com



**General description**

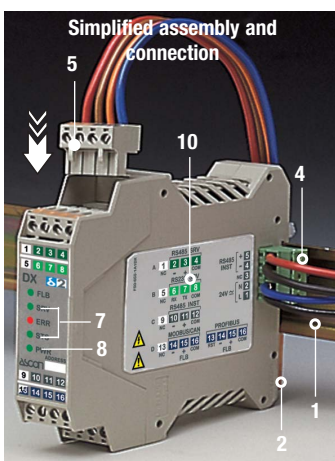

- 1 DIN-rail, EN60022
- 2 Spring loaded slide for rail fastening
- 3 Side connector, build-in, to connect one instrument to another (up to 32)
- 4 5-pole male connector, with screw terminals, for power supply and serial communications bus
- 5 Four quick polarised connectors with 4 screw terminals for comm.s ports
- 6 Female connector, with termination resistor for RS485 INST port

- 7 4 Communication ports status LEDs  
- FLB = Fieldbus activity  
- SRV = Service port activity  
- ERR = Error on the RS485 INST port  
- STS = System status
- 8 Power ON LED
- 9 Couple of connector protections
- 10 Wiring label
- 11 Model identification label

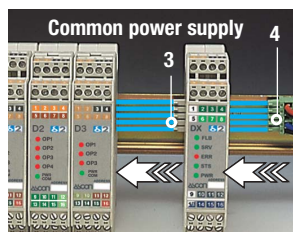
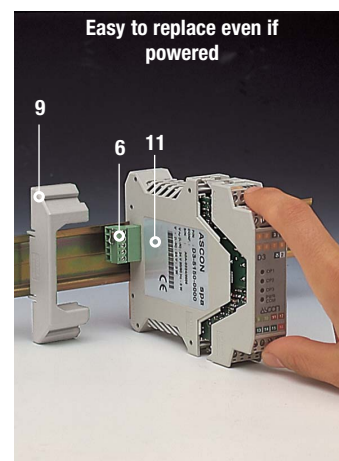

**Model code**

Mod. **DX** **5BC0** - **0F00**  
Line Basic Accessories

The product code indicates the specific hardware configuration of the instrument, that can be modified by specialized engineers only.

Line	D	X
Number of instruments to be backed up	B	
0	0	
4	1	
8	2	
16	3	
32	4	

Fieldbus Communications	C
None [1]	0
DeviceNet	1
RS485 Modbus/Jbus	5
Profibus DP SLAVE	7

User manual	F
Italian/English (std.)	0

[1] The instrument performs the hardware conversion RS232/485 only for the standard Modbus RTU protocol.



**Notes on electric safety and electromagnetic compatibility**

Please, read carefully these instructions before proceeding with the installation of the controller

**Class II instrument, rear panel mounting.**

This instrument has been designed in compliance with:

**Regulations on electrical apparatus:**

according to regulations on the essential protection requirements in electrical apparatus EN 61010-1

**Regulations on Electromagnetic Compatibility:**

according to:

- Regulations on RF emissions:  
EN61000-6-4 industrial environments;

- Regulation on RF immunity:  
EN61000-6-2 industrial equipment and system.

It is important to understand that it's responsibility of the installer to ensure the compliance of the regulations on safety requirements and EMC.

This controller has no user serviceable parts and requires special equipment and specialised engineers. Therefore, a repair can be hardly carried on directly by the user. For this purpose, the manufacturer provides technical assistance and the repair service for its Customers.

Please, contact your nearest Agent for further information.

All the information and warnings about safety and electromagnetic compatibility are marked with the sign, at the side of the note.

**Installation kit**

Each set of interconnected controllers requires one model **AD3-KIT/BA.RT.PC.CD** kit:

- Power supply and serial comm.s connector code AD3/BA
- Couple of connectors protections code AD3/PC
- Connector with termination resistor for serial communications code AD3/RT
- CD Rom with configuration software tool code AD3/CD

## Installation

### Dimensions

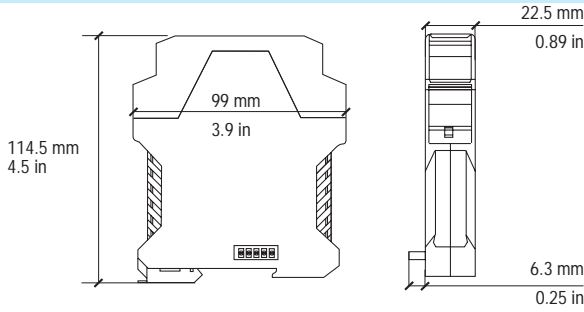

Environmental condition		CE	Suggestion
Operating conditions	Temperature	0...50 °C	
	Relative humidity	5...95% Rh non-condensing	
Special conditions	Temperature	> 50 °C	Use forced ventilation
	Relative humidity	> 95% RH	Warm up
Condizioni vietate	Conducting atmosphere		Use filter
	Corrosive atmosphere	Explosive atmosphere	

### Mounting on DIN rail (EN60022)

#### Mounting

- Clip the upper part of the instrument on the rail;
- Rotate the instrument downwards until the click.

When 2 or more instruments are installed on the same DIN rail, connect the communications/ power bus sliding the instruments side by side as explained in the following paragraphs.

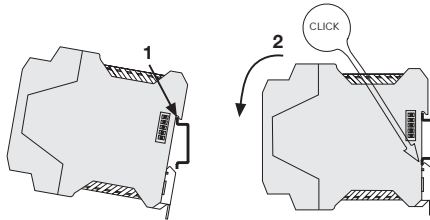

#### Disassembly

##### Switch the instrument off

When 2 or more instruments are installed on the same DIN rail, disconnect the communications/power bus separating the selected instrument from the others.

- Lower the spring slide by inserting a flat-blade screwdriver as indicated;
- Turn and lift the instrument upwards.

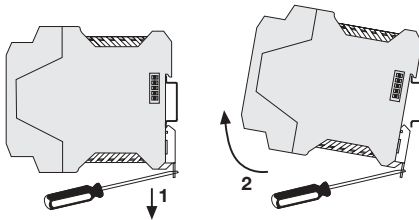

### Mounting other delatadue® instruments (up to 31) side by side

- After the mounting of instruments on the rail, put them side by side so that the male side connector fits into the corresponding female connector;
- After mounting all the instruments side by side insert the female 5-pole connector with the termination resistor of the serial communications into the corresponding male connector;
- Wire the 5-pole male power supply and serial communications connector and insert it in the corresponding female connector;
- When assembled insert the connectors protection on both sides.

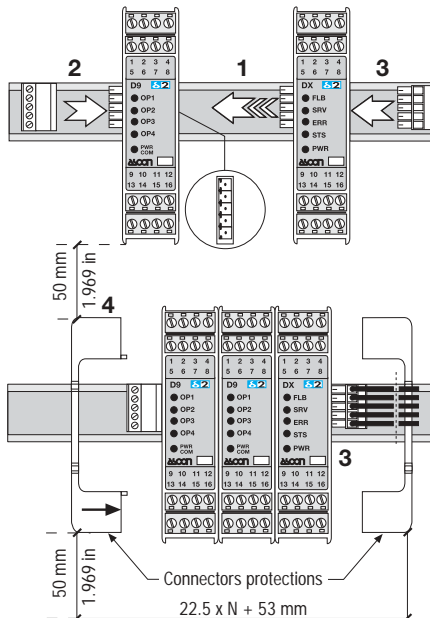

## Remove/insert the module from/in its housing

### How to remove the module from the housing

- Insert the blade of a negative screwdriver under the I/O polarised connectors;
- Moving the screwdriver as indicated, unplug the connector from the module;
- Remove the connector and repeat these steps in order to unplug all the external connections;
- With the blade of the screwdriver, press the two slots (at the top and bottom of the module) in order to free the I/O module from the housing;
- Firmly grip the front panel in the terminal block area and pull the module outside the housing.



### How to insert the I/O module in the housing

- In order to correctly re-insert the module in its housing, invert the previous extracting sequence, paying particular attention in inserting the printed circuit board in the slots present at the top and bottom of the case.

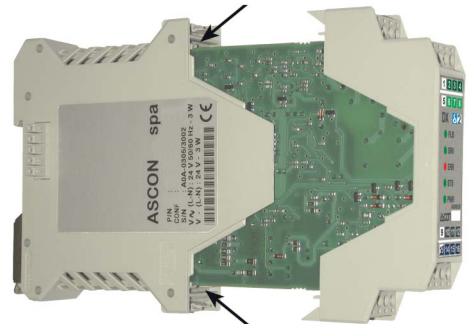



Terminal connectors and plugs

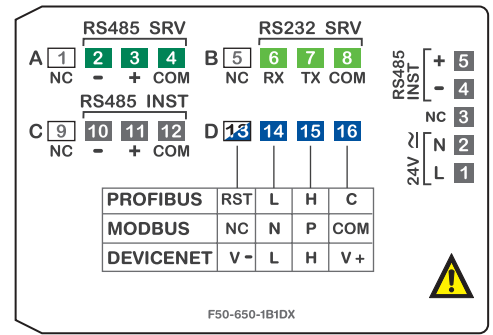
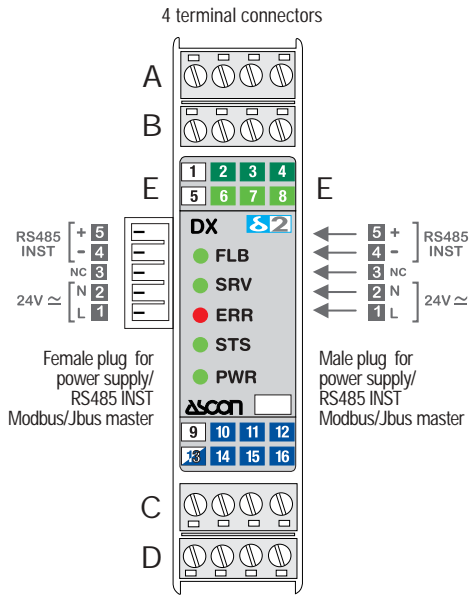

Features	Terminal connectors A-B-C-D	Power supply and communications connector
Flexible cable section:	0.2...2.5 mm <sup>2</sup> (AWG24...AWG12)	0.08...1.5 mm <sup>2</sup> (AWG28...AWG16)
Stripped wire	7 mm - 0.28 in	7 mm - 0.28 in
Negative screwdriver	0.6 x 3.5 mm	0.4 x 2.5 mm
Tightening torque	0.5...0.6 Nm	0.4...0.5 Nm

Precautions



All the wiring must comply with the local regulations.

The supply wiring should be routed away from the power cables.

Avoid to use electromagnetic contactors, power relays and high power motors nearby. Avoid power units nearby, especially if controlled in phase angle.

Keep the input low voltage sensor wires away from the power lines and the output cables. If this is not achievable, use shielded cables on the sensor input, with one end of the shield connected to earth.

Master/Gateway module wiring diagram example

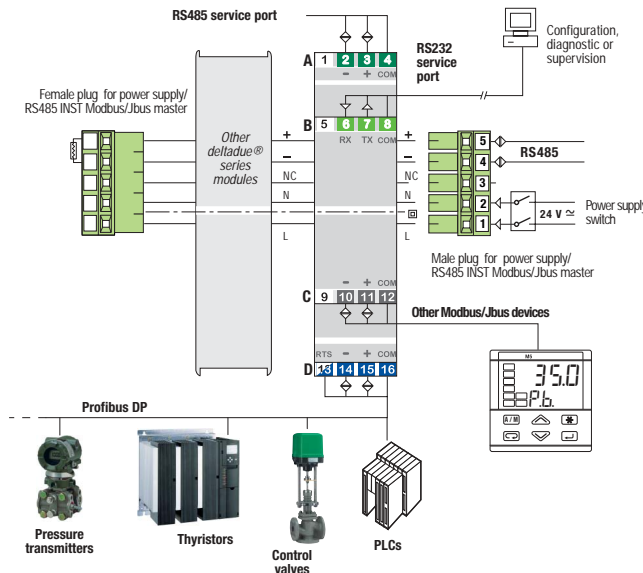

Notes



- 1 Make sure that the power supply voltage is the same indicated on the instrument.
- 2 Switch on the power supply only after all the electrical connections have been completed.
- 3 In accordance with the safety regulations, the power supply switch shall bring the identification of the relevant instrument. The power supply switch shall be easily accessible from the operator.
- 4 The instrument is PTC protected. In case of failure it is suggested to return the instrument to the manufacturer for repair.

Communications connectors and terminals

RS485 service port connector

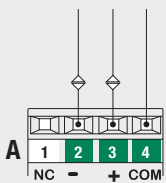

RS232 service port connector

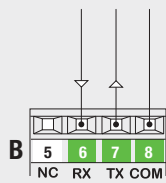

Frontal RS485 INST Modbus/Jbus master

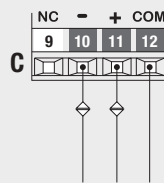

Fieldbus connector Profibus DP slave (option)

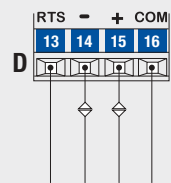

Fieldbus connector RS485 Modbus/Jbus slave (option)

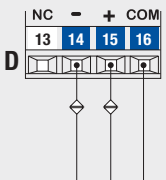

Fieldbus connector DeviceNet (option)

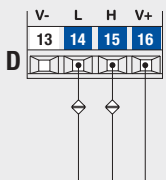

Power supply bus and RS485 INST Modbus/Jbus master

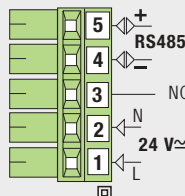

**Power supply:** Switching type with double insulation with incorporated PTC (resettable fuse).  
 Rated voltage: 24 Vac (-25...+12%) 50/60 Hz; 24 Vdc (-15...+25%).  
 Power consumption: 3 W max.  
 Protection: PTC protected.  
**Serial communications:** Passive and galvanically isolated interface 500 Vac/1 min.  
 Conforms to standard EIA RS 485, Modbus/Jbus protocol.

## Termination of the communication buses

### RS485 Service port

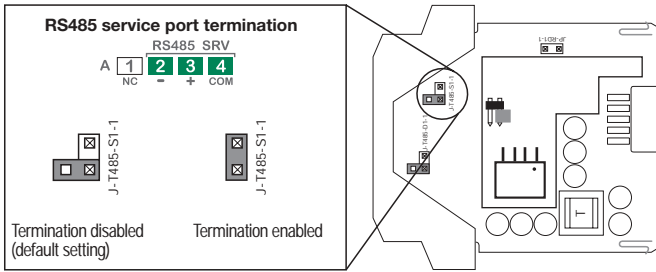

### Bus RS485 INST (replicated on the front of the module)

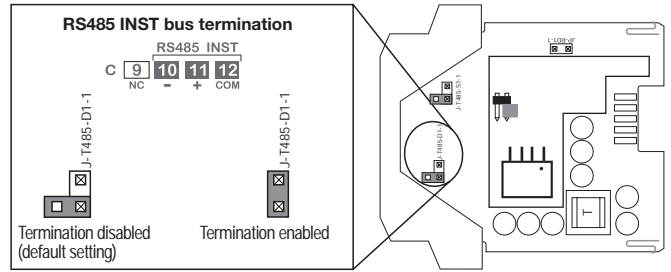

### Fieldbus: RS485 Modbus/Jbus

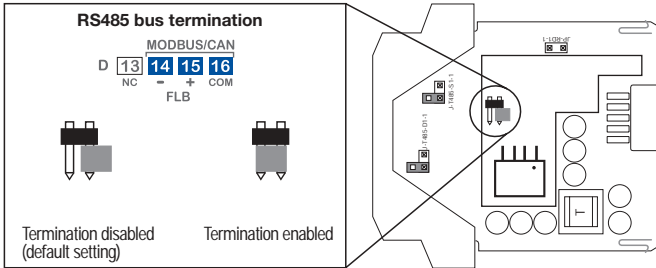

### JP-RD1 jumper

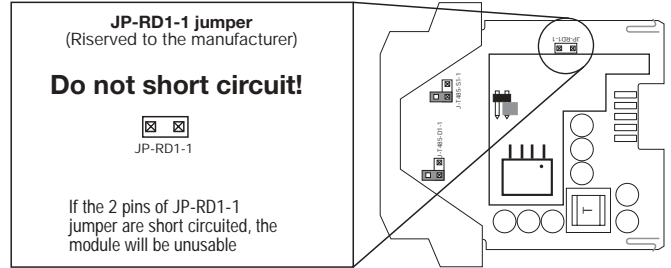

## DIP switch selectors setting

**RS485 INST bus baud rate**

DIP switches 1, 2 and 3 of SW-1 are used to set the RS485 INST bus baud rate. In the drawing the switches are set to obtain 9600 baud (default value)

**Automatic learning enabling**

DIP switch 4 of SW- enables the automatic learning function at power ON. In the drawing the switch is set to disable the automatic learning (default value)

**Service port reset**

In order to reset the serial communication parameters of the service port to the default values (9600, N, 8, 1), set DIP switches 1, 2, 3 and 4 of SW1 to ON; then insert the module in its housing and power ON the instrument. Extract the module from its plastic case and set the DIP switches in the desired position.

Baud rate (baud)	DIP switch		
	1	2	3
1200	OFF	OFF	OFF
2400	ON	OFF	OFF
4800	OFF	ON	OFF
9600	ON	ON	OFF
19200	OFF	OFF	ON

Automatic learning function	DIP switch
The automatic learning cycle is executed at power ON	ON
The automatic learning cycle is not executed at power ON	OFF

DIP switch				Function
1	2	3	4	
ON	ON	ON	ON	Set the switches as indicated to reset the communications parameters of the service bus to the default values (9600, N, 8, 1)

## Module status and service LEDs

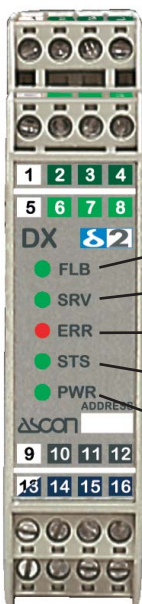

Label	Name	Details
FLB	FieldBus	Fieldbus port status. <b>Flashes</b> while the Gateway/Manager module is communicating through the Fieldbus port.
SRV	Service	Service port status. <b>Flashes</b> while the Gateway/Manager module is communicating through the Service port.
ERR	Error	One or more instruments connected to the RS485 INST bus detected and stored with the auto learning function are not correctly functioning. <b>Flashes</b> when the module detects an error on the RS485 INST bus.
STS	Status	System status. <b>Steady ON</b> when the Gateway is active; <b>Not lit</b> when the module is functioning in normal mode; <b>Flashes</b> during the auto learning session.
PWR	Power	<b>Steady ON</b> when the module is powered; <b>Not lit</b> the Power is OFF or the jumper JP-RD1-1 is shorted; <b>Flashes</b> the module is powered, but is not yet ON as it is waiting the end of the Power ON delay.