

MOTOR CONTROL

Mini-Contactors and Thermal Overload Relays

SK Series



Mini-Contactors and Thermal Overload Relays

SK Series: SK06, SK09, and SK12

The Smallest Class of Magnetic Contactors and Thermal Overload Relays in the World

Magnetic Contactors: SK06, SK09, and SK12

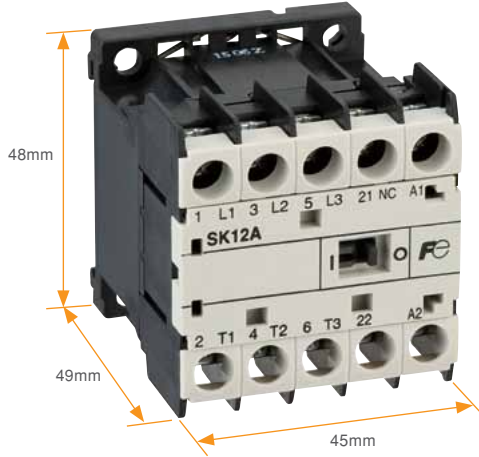

Smallest Mini-Contactors in the World

- At 45 × 48 × 49mm (W×H×D), these Contactors achieve the same dimensions for AC-operated and DC-operated models.

Complete Lineup

- Models available with 3 different ratings: 6A, 9A, or 12A.
- Models available with AC, DC, or low-power operating coils.

Enhanced Safety and Applicability

- Standard-feature removable terminal cover (IP20).
- Mirror contacts.
- Short-circuit current rating (SCCR): 50kA 480V
* When used in combination with an MMS.
- UL ratings: 480V 5HP
- IEC ratings: 480V 12A (AC-3)

Environment

- RoHS Compliant (EU Restriction of the Use of Certain Hazardous Substances in Electrical and Electronic Equipment)
The materials used do not contain any of the six substances that are specified in the RoHS Directive or have less than the specified content percentages of those substances.

International Safety Standards for Standard Models

- International standards for standard models: IEC, GB (CCC), JIS, UL, and TÜV

Standard Compliance

Product	Type	Compliant Standards			Certified Standards			EC Directives	Certifying Body
		IEC	EN	JIS	UL	CSA	GB	CE Marking	TÜV
		International	Europe	Japan	USA	Canada	China	Europe	Germany
Magnetic Contactors	SK □ A	■	■	■	■	■	■	■	■
	SK □ G	■	■	■	■	■	■	■	■
	SK □ L	■	■	■	■	■	■	■	■
Thermal Overload Relays	TK12	■	■	■	■	■	■	■	■

Note: Legend ■ : Compliance with standard models.

Low Power Consumption

- The operating coil uses a newly designed electromagnet section to help save power for both AC and DC models.

DC Coil

Standard DC coil : 2.4W
Low-power DC coil : 1.2W

* Up to two auxiliary contacts can be added.

Directly drive these Contactors with DC transistor outputs from PLCs or other devices.

86% of previous models

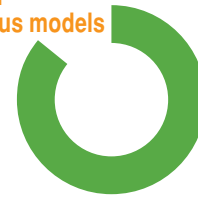

Comparison with FUJI SJ Series

AC Coil

Power consumption

Inrush: 22VA

69% of previous models

Sealed: 4.5VA

75% of previous models

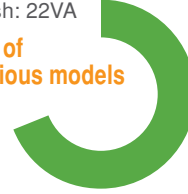

Comparison with FUJI SC-M Series

Many Options

- Auxiliary Contact Blocks (2-pole, 4-pole, or compact 2-pole)
- Coil Surge Suppression Unit
- Interlock Unit
- Link Modules (for use in combination with an MMS).

Auxiliary Contact Blocks (2-pole or 4-pole)



Auxiliary Contact Blocks (compact 2-pole)



Coil Surge Suppression Unit



Interlock Unit



Thermal Overload Relays: TK12



Downsizing

- Combine a Thermal Overload Relay with a Magnetic Contactor for Meaningful Downsizing

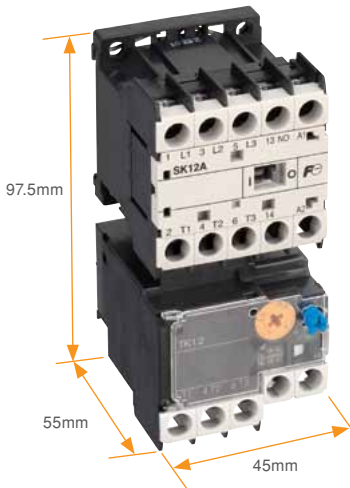

Footprint
87% of previous models

Volume
55% of previous models

Comparison with FUJI SJ Series

Enhanced Safety

- 2E Thermal Overload Relay overload and phase-loss protection with standard models.
- A standard-feature transparent cover that serves as a dial lock and that also protects against unintentional operation of the reset button.

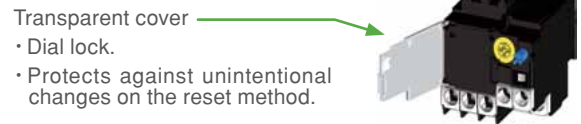

Easier Wiring

① Connection to Round Crimp Terminals

Standard-feature easy-to-remove terminal cover.

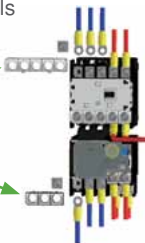

② Terminal Arrangement for No Interference between Power Lines for Main and Auxiliary Circuits When Wiring

TK12

The difficulties in wiring caused by the previous terminal arrangement have been eliminated.

Previous Models

The main circuits were difficult to wire because the screwdriver had to be held at an angle due to interference from the auxiliary circuits.

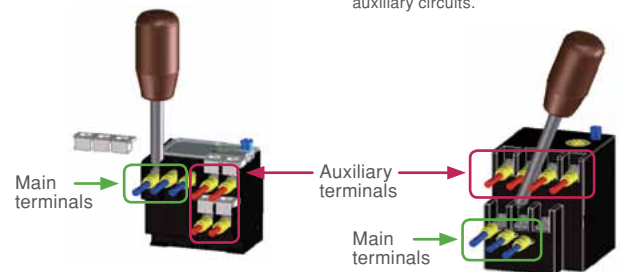

Auxiliary Relays: SKH4

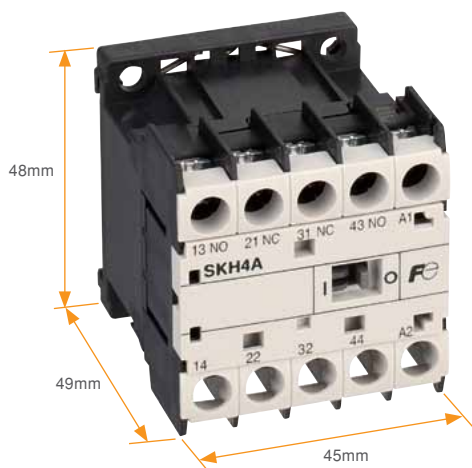

Downsizing

- Both AC-operated and DC-operated (2.4W and 1.2W) models are available and have the same shape as the Magnetic Contactors.
- Add up to eight contacts with the addition of Auxiliary Contact Blocks (2-pole or 4-pole). A compact, 2-pole Auxiliary Contact Blocks with a reduced depth dimension is also available.

High Reliability and Safety

- Lineup includes models with bifurcated contact for high reliability (standard models) and high-capacity models (single button contact).
- Auxiliary Relays with linked contacts. (Complies with requirements of IEC60947-5-1 Annex L.)

Contact specifications [arrangement]	High-reliability (standard) models [bifurcated contact]	High-capacity models [single button contact]
Type	SKH4 □	SKH4 □ H
Conventional free air thermal current (Rated continuous current)	10A	10A
Coil load and rated operational current (AC-15)	100-120V	3A
	200-240V	3A
	380-440V	1A
	500-600V	0.5A
Minimum voltage and current	5V DC, 3mA	24V DC, 10mA
Linked contact		○

Catalog Disclaimer

The information contained in this catalog does not constitute an express or implied warranty of quality, any warranty of merchantability or fitness for a particular purpose is hereby disclaimed.

Since the user's product information, specific use application, and conditions of use are all outside of Fuji Electric FA Components & Systems' control, **it shall be the responsibility of the user to determine the suitability of any of the products mentioned for the user's application.**

One Year Limited Warranty

The products identified in this catalog shall be sold pursuant to the terms and conditions identified in the "Conditions of Sale" issued by Fuji Electric FA with each order confirmation.

Except to the extent otherwise provided for in the Conditions of Sale issued by Fuji Electric FA, Fuji Electric FA warrants that the Fuji Electric FA products identified in this catalog shall be free from significant defects in materials and workmanship provided the product has not been: 1) repaired or altered by others than Fuji Electric FA; 2) subjected to negligence, accident, misuse, or damage by circumstances beyond Fuji Electric FA's control; 3) improperly operated, maintained or stored; or 4) used in other than normal use or service. This warranty shall apply only to defects appearing within one (1) year from the date of shipment by Fuji Electric FA, and in such case, only if such defects are reported to Fuji Electric FA within thirty (30) days of discovery by purchaser. Such notice should be submitted in writing to Fuji Electric FA at 5-7, Nihonbashi Odemma-cho, Chuo-ku, Tokyo, Japan. The sole and exclusive remedy with respect to the above warranty whether such claim is based on warranty, contract, negligence, strict liability or any other theory, is limited to the repair or replacement of such product or, at Fuji Electric FA's option reimbursement by Fuji Electric FA of the purchase price paid to Fuji Electric FA for the particular product. **Fuji Electric FA does not make any other representations or warranties, whether oral or in writing, expressed or implied, including but not limited to any warranty regarding merchantability or fitness for a particular purpose.** Except as provided in the Conditions of Sale, no agent or representative of Fuji Electric FA is authorized to modify the terms of this warranty in writing or orally.

In no event shall Fuji Electric FA be liable for special, indirect or consequential damages, including but not limited to, loss of use of the product, other equipment, plant and power system which is installed with the product, loss of profits or revenues, cost of capital, or claims against the purchaser or user of the product by its customers resulting from the use of information, recommendations and descriptions contained herein. The purchaser agrees to pass on to its customers and users, in writing at the time inquiries and orders are received by buyer, Fuji Electric FA's warranty as set forth above.

Safety Considerations

- Operate (keep) in the environment specified in the operating instructions and manual. High temperature, high humidity, condensation, dust, corrosive gases, oil, organic solvents, excessive vibration or shock might cause electric shock, fire, erratic operation or failure.
- For safe operation, before using the product read the instruction manual or user manual that comes with the product carefully or consult the Fuji sales representative from which you purchased the product.
- Products introduced in this catalog have not been designed or manufactured for such applications in a system or equipment that will affect human bodies or lives.
- Customers, who want to use the products introduced in this catalog for special systems or devices such as for atomic-energy control, aerospace use, medical use, passenger vehicle, and traffic control, are requested to consult with Fuji Electric FA.
- Customers are requested to prepare safety measures when they apply the products introduced in this catalog to such systems or facilities that will affect human lives or cause severe damage to property if the products become faulty.
- For safe operation, wiring should be conducted only by qualified engineers who have sufficient technical knowledge about electrical work or wiring.
- Follow the regulations of industrial wastes when the product is to be discarded.
- For further questions, please contact your Fuji sales representative or Fuji Electric FA.

Mini-Contactors SK Series











	Page
Standard Models	6
Production Models	7
Type Number Nomenclature (Magnetic Contactors and Thermal Overload Relays)	8
Ratings	
Main Circuit Ratings	10
Auxiliary Circuit Ratings.....	11
Operating Coil Voltages	12
Operating Coil Characteristics.....	13
Performances	14
AC-3 Breaking Current and Electrical Durability.....	14
Protective Coordination	
Coordination with Short-circuit Protection Devices (SCPD) (Based on IEC and JIS Standards).....	16
UL approved Short-circuit Current Ratings (SCCR)	18
Normal Operating Conditions and Mounting	20
Wiring	21
Handling	22
Magnetic Contactors	
Features	24
Ordering Information	24
Ratings and Types	24
Dimensions and Connection Diagrams	25
Reversing Magnetic Contactors	
Features	26
Ordering Information	26
Ratings and Types	26
Dimensions and Connection Diagrams	27
Thermal Overload Relays	
Features	28
Ordering Information	28
Ratings and Types	28
Ampere Setting Range Specification Codes	28
Auxiliary Circuit Ratings.....	29
Operating Characteristics (Specifications)	29
Operating Characteristics Curves (Average Values)	30
Dimensions and Connection Diagrams	30
Optional Unit	
Type Numbers and Product Codes.....	31
Auxiliary Contact Blocks	32
Mechanical Interlock Unit and Power Connection Kit for Reversing	34
Main Circuit Surge Suppression Unit and Separate Installation Unit	35
Coil Surge Suppression Units and Operation Indicator Lamps	36
Thermal Overload Relay Reset Releases	37
Link Module and Power Connection Kit for Reversing (Insert)	38
Auxiliary Relays.....	40

Mini-Contactors

SK Series

Standard Models

■ Standard Models

Series		SK Series				
Frame		06	09	12		
Magnetic Contactor appearance						
		(Photo No. 11-062)				
Type	Magnetic Contactors	AC-operated models	SK06A	SK09A	SK12A	
		DC-operated models (2.4W)	SK06G	SK09G	SK12G	
		DC-operated models (1.2W)	SK06L	SK09L	SK12L	
	Thermal Overload Relay		TK12			
Rated insulation voltage (IEC)		690V	690V	690V		
Rated impulse withstand voltage (IEC)		6kV	6kV	6kV		
Rated frequency		50-60Hz	50-60Hz	50-60Hz		
Main circuit ratings	3-phase squirrel-cage motor capacity [kW] AC-3 IEC60947-4-1	200-240V	1.5kW	2.2kW	3kW	
		380-440V	2.2kW	4kW	5.5kW	
		500-550V	3kW	4kW	5.5kW	
		600-690V	3kW	4kW	4kW	
	Rated current Ie [A] AC-3	200-240V	6A	9A	12A	
		380-440V	6A	9A	12A	
		500-550V	5A	7A	9A	
		600-690V	3.5A	5A	5A	
	Conventional free air thermal current (Rated continuous current) Ith [A]		20A	20A	20A	
	Performances	Operating cycles per hour [times/hour]		1800	1800	1800
Durability (x 10,000)		Mechanical	1000	1000	1000	
		Electrical (AC-3)	100	100	100	
Dimensions WxHxD [mm]		45x48x49	45x48x49	45x48x49		
Options	Auxiliary Contact Blocks	Head-on (2-pole)	☉			
		Head-on (4-pole) *1	☉			
	Interlock Unit		☉			
	Coil Surge Suppression Unit		☉			
	Main Circuit Surge Suppression Unit		☉			
Standards		      				

Note: *1 These products cannot be combined with the SK□L.

Mini-Contactors SK Series Standard Models and Production Models

■ Thermal Overload Relays

Thermal Overload Relay appearance				
	(Photo No. KKD11-122)			
Type	TK12			
Protection	Overload and phase-loss protection			
Ampere setting range The heating element code is given in brackets.	0.1-0.15A [P10] 0.13-0.2A [P13] 0.18-0.27A [P18] 0.24-0.36A [P24] 0.34-0.52A [P34]	0.48-0.72A [P48] 0.64-0.96A [P64] 0.8-1.2A [P80] 0.95-1.45A [P95] 1.4-2.1A [1P4]	1.7-2.6A [1P7] 2.2-3.4A [2P2] 2.8-4.2A [2P8] 4-6A [004] 5-7.5A [005]	6-9A [006] 7-10.5A [007] 9-13A [009]

■ Production Models

Magnetic Contactors and Magnetic Starters

Product		Type *1	Frame size		
			06	09	12
Magnetic Contactors	AC-operated models	SK □ A	○	○	○
	DC-operated models (standard)	SK □ G	○	○	○
	DC-operated models (low power consumption)	SK □ L	○	○	○
Reversing Contactors	AC-operated models	SK □ AR	○	○	○
	DC-operated models (standard)	SK □ GR	○	○	○
	DC-operated models (low power consumption)	SK □ LR	○	○	○

Note: *1 In the □ mark, is replaced with the frame size.

Mini-Contactors

SK Series

Type Number Nomenclature

■ Type Number Nomenclature

● Type Number Nomenclature (Type Number = Product Code)

- Magnetic Contactors

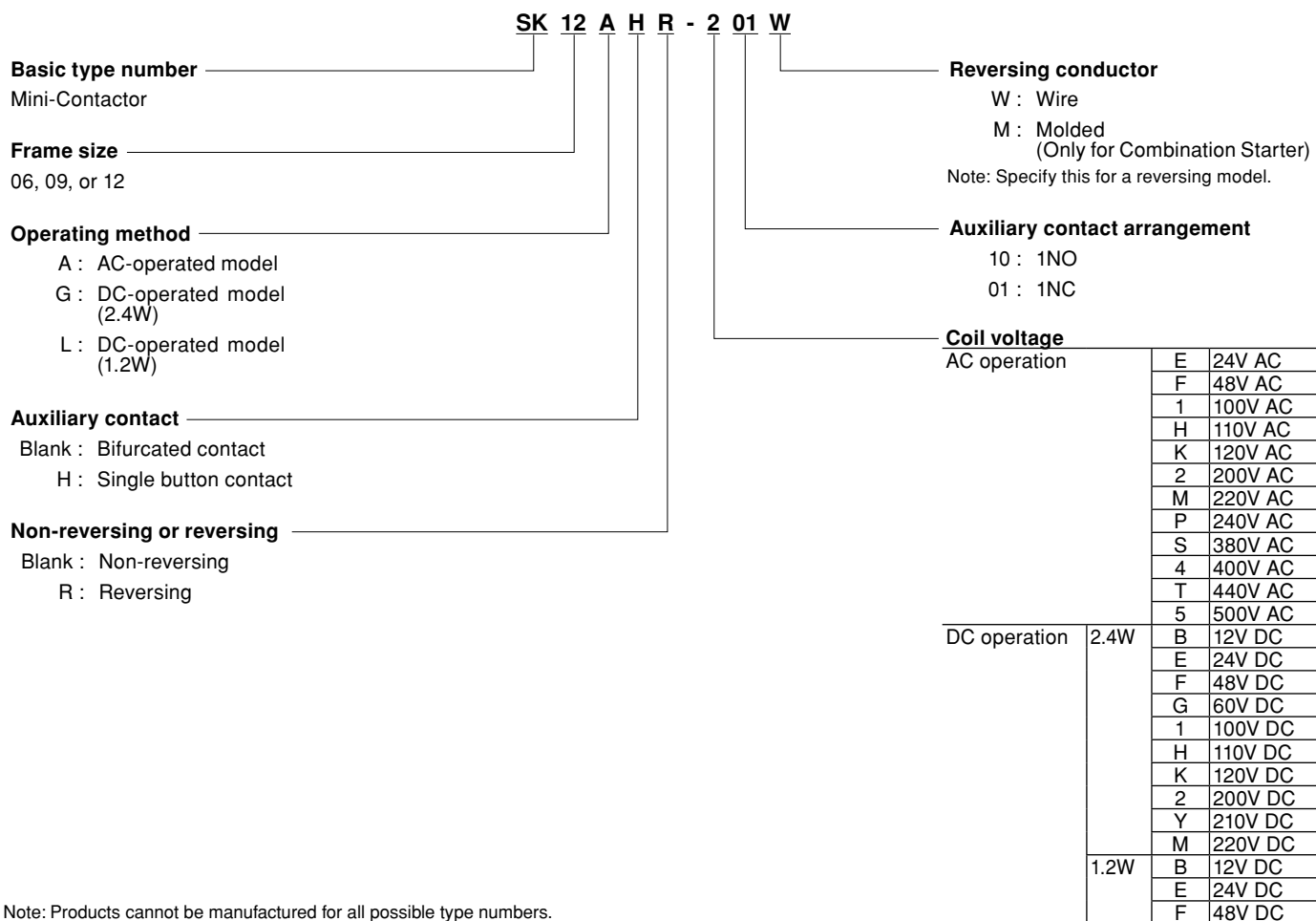

Note: Products cannot be manufactured for all possible type numbers.

Mini-Contactors SK Series Type Number Nomenclature

• Thermal Overload Relays

TK 12 W A - 009

Basic type number

TK : 2E Thermal Overload Relay
(with phase-loss detection)

Frame size

12

Mounting

W : On-contactor mounting

Reset method

Blank : Manual reset (standard)

A : Automatic reset

Ampere setting range

- P10 : 0.1-0.15A
- P13 : 0.13-0.2A
- P18 : 0.18-0.27A
- P24 : 0.24-0.36A
- P34 : 0.34-0.52A
- P48 : 0.48-0.72A
- P64 : 0.64-0.96A
- P80 : 0.8-1.2A
- P95 : 0.95-1.45A
- 1P4 : 1.4-2.1A
- 1P7 : 1.7-2.6A
- 2P2 : 2.2-3.4A
- 2P8 : 2.8-4.2A
- 004 : 4-6A
- 005 : 5-7.5A
- 006 : 6-9A
- 007 : 7-10.5A
- 009 : 9-13A

Mini-Contactors

SK Series

Ratings

Ratings

■ Main Circuit Ratings

- IEC-conformance Ratings (IEC 60947-4-1, EN 60947-4-1, and VDE 0660)

Type	Max. motor capacity [kW]				Operational current [A]						Conventional free air thermal current [A] (Rated thermal current)
	3-phase squirrel-cage motor (AC-3)				3-phase squirrel-cage motor (AC-3)				Resistance (AC-1)		
	200-240V	380-440V	500-550V	600-690V	200-240V	380-440V	500-550V	600-690V	200-240V	380-440V	
SK06	1.5	2.2	3	3	6	6	5	3.5	12	12	20
SK09	2.2	4	4	4	9	9	7	5	16	16	20
SK12	3	5.5	5.5	4	12	12	9	5	20	20	20

Note: AC-3 electrical durability: 1,000,000 operations

- UL/CSA-conformance Ratings (UL60947-4-1A and CSA C22.2)

Type	Max. motor capacity [HP]				Operational current [A]				Rated continuous current [A]
	3-phase motor				3-phase motor				
	200V	220-240V	440-480V	550-600V	200V	220-240V	440-480V	550-600V	
SK06	1-1/2	2	3	5	6.9	6.8	4.8	6.1	20
SK09	2	3	5	5	7.8	9.6	7.6	6.1	20
SK12	3	3	5	5	11	9.6	7.6	6.1	20

Type	Max. motor capacity [HP]			Operational current [A]			Rated continuous current [A]
	Single-phase motor			Single-phase motor			
	110-120V	200V	220-240V	110-120V	200V	220-240V	
SK06	1/2	3/4	1	9.8	7.9	8	20
SK09	3/4	1	1-1/2	13.8	9.2	10	20
SK12	1	1-1/2	2	16	11.5	12	20

Note: Use wires that are rated for 75°C.

■ Auxiliary Circuit Ratings

● IEC-conformance Ratings (Standard Models: Bifurcated Contact)

Type	Conventional free air thermal current [A] (Rated thermal current)	Making and breaking current (AC)	Rated operational current [A]						Minimum voltage and current
			AC rated operational voltage [V]	AC-15 (Ind. load)	AC-12 (Res. load)	DC rated operational voltage [V]	DC-13 (Ind. load)	DC-12 (Res. load)	
SK06 SK09 SK12 SKH4	10	30	100-120	3	6	24	2	3	5V DC, 3mA
		30	200-240	3	6	48	1	2	
		10	380-440	1	6	110	0.3	1.5	
		5	500-600	0.5	3	220	0.2	0.5	

Note: The failure level is 10^{-7} for a normal environment without dust, dirt, or corrosive gas.
The ratings of additional auxiliary contacts are the same as those given above.

● IEC-conformance Ratings (Single Button Contact)

Type	Conventional free air thermal current [A] (Rated thermal current)	Making and breaking current (AC)	Rated operational current [A]						Minimum voltage and current
			AC rated operational voltage [V]	AC-15 (Ind. load)	AC-12 (Res. load)	DC rated operational voltage [V]	DC-13 (Ind. load)	DC-12 (Res. load)	
SK06□H SK09□H SK12□H SKH4□H	10	60	100-120	6	10	24	4	8	24V DC, 10mA
		60	200-240	6	10	48	1	3.5	
		60	380-440	6	10	110	0.5	2.5	
		30	500-600	3	5	220	0.25	0.8	

Note: The failure level is 10^{-7} for a normal environment without dust, dirt, or corrosive gas.
The ratings of additional auxiliary contacts are the same as those given above.

● UL/CSA-conformance Ratings (Bifurcated Contact or Single Button Contact)

Type	Rated continuous current [A]	Rated operational current [A]						Rating code	
		AC			DC			AC	DC
		Rated operational voltage [V]	Making	Breaking	Rated operational voltage [V]	Making	Breaking		
SK06 SK09 SK12 SKH4	10	120	60	6	125	0.55	0.55	A600	Q300
		240	30	3					
		480	15	1.5	250	0.27	0.27		
		600	12	1.2					

Mini-Contactors

SK Series

Ratings

■ Operating Coil Voltages

● AC-operated Models

Type	Order voltage	Code	Coil voltage and frequency
SK06A SK09A SK12A	24V AC	E	24V 50Hz / 24-26V 60Hz
	48V AC	F	48V 50Hz / 48-52V 60Hz
	100V AC	1	100V 50Hz / 100-110V 60Hz
	110V AC	H	100-110V 50Hz / 110-120V 60Hz
	120V AC	K	110-120V 50Hz / 120-130V 60Hz
	200V AC	2	200V 50Hz / 200-220V 60Hz
	220V AC	M	200-220V 50Hz / 220-240V 60Hz
	240V AC	P	220-240V 50Hz / 240-260V 60Hz
	380V AC	S	346-380V 50Hz / 380-420V 60Hz
	400V AC	4	380-400V 50Hz / 400-440V 60Hz
	440V AC	T	415-440V 50Hz / 440-480V 60Hz
	500V AC	5	480-500V 50Hz / 500-550V 60Hz

● DC-operated Models (2.4W)

Type	Order voltage	Code	Coil voltage
SK06G SK09G SK12G	12V DC	B	12V DC
	24V DC	E	24V DC
	48V DC	F	48V DC
	60V DC	G	60V DC
	100V DC	1	100V DC
	110V DC	H	110V DC
	120V DC	K	120V DC
	200V DC	2	200V DC
	210V DC	Y	210V DC
	220V DC	M	220V DC

● DC-operated Models (1.2W)

Type	Order voltage	Code	Coil voltage
SK06L SK09L SK12L	12V DC	B	12V DC
	24V DC	E	24V DC
	48V DC	F	48V DC

■ Operating Coil Characteristics

● AC-operated Models

Type	Power consumption [VA]				Watt loss [W]		Pick-up voltage [V]		Drop-out voltage [V]		Operating times [ms]	
	Inrush		Sealed		200V 50Hz	220V 60Hz	50Hz	60Hz	50Hz	60Hz	Coil ON → Contact ON	Coil OFF → Contact OFF
SK06A SK09A SK12A	200V 50Hz	220V 60Hz	200V 50Hz	220V 60Hz								
	22	25	4.5	4.5	1.2	1.3	122-135	128-138	80-89	83-96		

Note 1. The characteristics are for the following coil ratings: 200V, 50Hz/200 to 220V, 60Hz.

Note 2. The electromagnet capacity is the same even when the rated coil voltage is not 200V AC.

Note 3. The operating times are for 200V AC, 50Hz.

Note 4. The pick-up voltage and drop-out voltage for a 100V (100V AC, 50 Hz/100 to 110V, 60Hz) coil are approximately half of the values that are given in the above table.

Note 5. The values in the above table are examples for a cold status at 20°C.

● DC-operated Models (2.4W)

Type	Power consumption [W]		Time constant [ms]	Pick-up voltage [V]	Drop-out voltage [V]	Operating times [ms]	
	Inrush	Sealed	Sealed			Coil ON → Contact ON	Coil OFF → Contact OFF
SK06G SK09G SK12G	24V	24V	20	10-11	4-6	22-24	5-6
	2.4	2.4	20	10-11	4-6	22-24	5-6

Note 1. The characteristics are for the following coil rating: 24V DC.

Note 2. The electromagnet capacity is the same even when the rated coil voltage is not 24V DC.

Note 3. The values in the above table are examples for a cold status at 20°C.

● DC-operated Models (1.2W)

Type	Power consumption [W]		Time constant [ms]	Pick-up voltage [V]	Drop-out voltage [V]	Operating times [ms]	
	Inrush	Sealed	Sealed			Coil ON → Contact ON	Coil OFF → Contact OFF
SK06L SK09L SK12L	24V	24V	20	13-14	4-5	30-33	8-9
	1.2	1.2	20	13-14	4-5	30-33	8-9

Note 1. The characteristics are for the following coil rating: 24V DC.

Note 2. The electromagnet capacity is the same even when the rated coil voltage is not 24V DC.

Note 3. The values in the above table are examples for a cold status at 20°C.

Mini-Contactors SK Series Ratings

■ Performances

Type	Rated operational voltage [V]	Rated operational current [A]	Making/breaking current [A]		Operating cycles per hour [times/hour]	Durability (Operations)	
			Making	Breaking		Mechanical	Electrical
SK06	220	6	72	60	1800	10 million	1 million
	440	6	72	60			
SK09	220	9	108	90			
	440	9	108	90			
SK12	220	12	144	120			
	440	12	144	120			

■ AC-3 Breaking Current and Electrical Durability

● SK06 to SK12

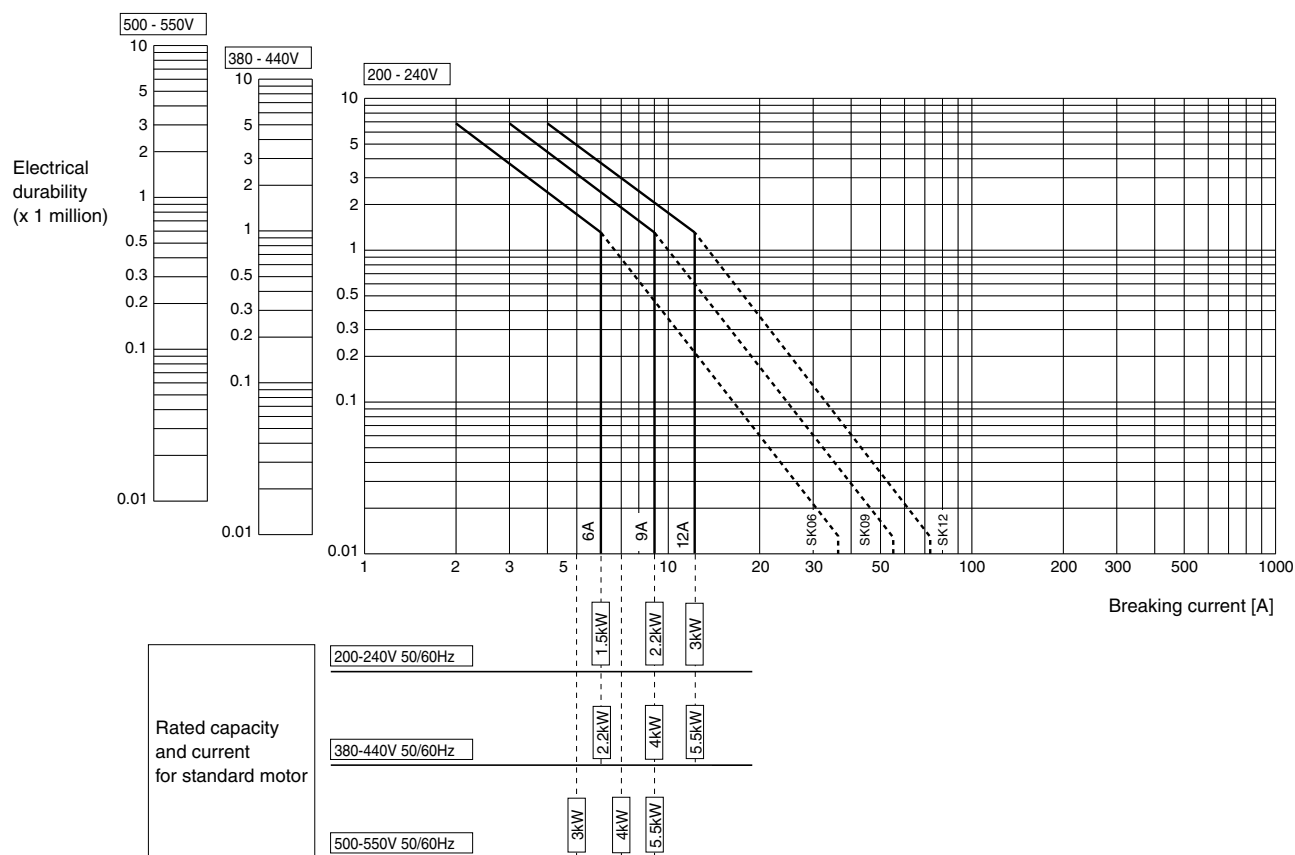

■ AC-1 Breaking Current and Electrical Durability

- SK06 to SK12

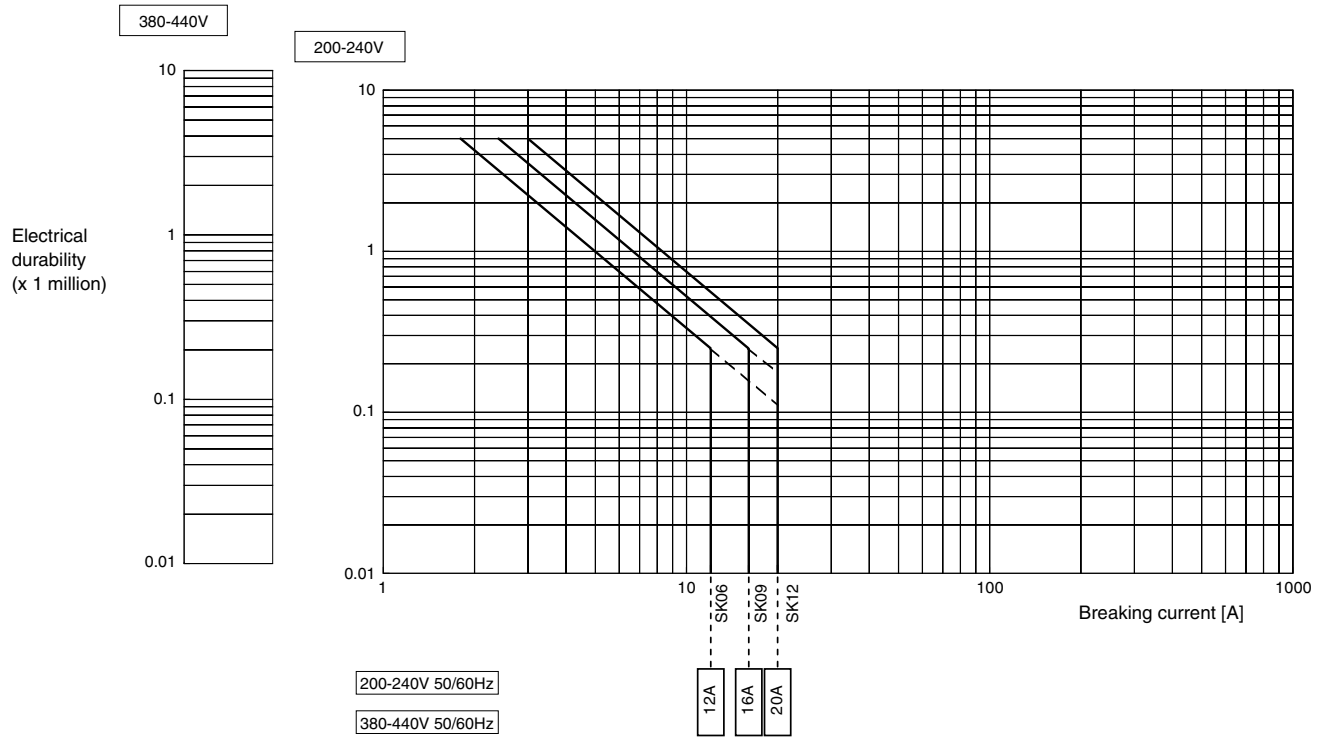

Mini-Contactors

SK Series

Protective Coordination

■ Coordination with Short-circuit Protection Devices (SCPD) (Based on IEC and JIS Standards)

● Prospective Short-circuit Current “r” (240V and 440V)

Magnetic Contactor	Thermal Overload Relay		Coordination type						
			Type 1				Type 2		
	Type	Ampere setting range [A]	Short-circuit current “r” [kA]	FUJI Automatic Breaker / Earth Leakage Circuit Breaker		Short-circuit current “r” [kA]	Fuse (IEC 60269-1 gG and gM) rating (A)	FUJI Low-voltage Current-limiting Fuse	
			Type	Rating [A]			Type	Rating [A]	
SK06	TK12	0.34-0.52	1	BW32SAG EW32SAG	3	1	2	BLA003	3
		0.48-0.72	1		3	1	4	BLA005	5
		0.64-0.96	1		5	1	4	BLA005	5
		0.8-1.2	1		5	1	4	BLA005	5
		0.95-1.45	1		10	1	16	BLA020	20
		1.4-2.1	1		20	1	16	BLA020	20
		1.7-2.6	1		20	1	16	BLA020	20
		2.2-3.4	1		20	1	16	BLA020	20
		2.8-4.2	1		20	1	16	BLA020	20
		4-6	1		20	1	16	BLA020	20
SK09	TK12	0.34-0.52	1	BW32SAG EW32SAG	3	1	2	BLA003	3
		0.48-0.72	1		3	1	4	BLA005	5
		0.64-0.96	1		5	1	4	BLA005	5
		0.8-1.2	1		5	1	4	BLA005	5
		0.95-1.45	1		10	1	16	BLA020	20
		1.4-2.1	1		20	1	16	BLA020	20
		1.7-2.6	1		20	1	16	BLA020	20
		2.2-3.4	1		20	1	16	BLA020	20
		2.8-4.2	1		20	1	16	BLA020	20
		4-6	1		20	1	16	BLA020	20
		5-7.5	1		20	1	16	BLA020	20
6-9	1	20	1	16	BLA020	20			
SK12	TK12	0.34-0.52	1	BW32SAG EW32SAG	3	1	2	BLA003	3
		0.48-0.72	1		3	1	4	BLA005	5
		0.64-0.96	1		5	1	4	BLA005	5
		0.8-1.2	1		5	1	4	BLA005	5
		0.95-1.45	1		10	1	16	BLA020	20
		1.4-2.1	1		20	1	16	BLA020	20
		1.7-2.6	1		20	1	16	BLA020	20
		2.2-3.4	1		20	1	16	BLA020	20
		2.8-4.2	1		20	1	16	BLA020	20
		4-6	1		20	1	16	BLA020	20
		5-7.5	1		20	1	16	BLA020	20
		6-9	1		20	1	16	BLA020	20
		7-10.5	1		20	1	16	BLA020	20
9-13	1	30	1	16	BLA020	20			

Mini-Contactors SK Series Protective Coordination

● Rated conditional short-circuit current I_q (240V and 440V)

Magnetic Contactor	Thermal Overload Relay		Coordination type						
			Type 1			Type 2			
	Type	Ampere setting range [A]	Short-circuit current "I _q " [kA]	FUJI Automatic Breaker / Earth Leakage Circuit Breaker		Short-circuit current "I _q " [kA]	Fuse (IEC 60269-1 gG and gM) rating (A)	FUJI Low-voltage Current-limiting Fuse	
			Type	Rating [A]			Type	Rating [A]	
SK06	TK12	0.34-0.52	10	BW32SAG EW32SAG	3	50	2	BLA003	3
		0.48-0.72	10		3	50	4	BLA005	5
		0.64-0.96	10		5	50	4	BLA005	5
		0.8-1.2	10		5	50	4	BLA005	5
		0.95-1.45	10		10	50	16	BLA020	20
		1.4-2.1	10		10	50	20	BLA030	30
		1.7-2.6	10		10	50	20	BLA030	30
		2.2-3.4	10		10	50	20	BLA030	30
		2.8-4.2	10		10	50	20	BLA030	30
		4-6	10		10	50	20	BLA030	30
SK09	TK12	0.34-0.52	10	BW32SAG EW32SAG	3	50	2	BLA003	3
		0.48-0.72	10		3	50	4	BLA005	5
		0.64-0.96	10		5	50	4	BLA005	5
		0.8-1.2	10		5	50	4	BLA005	5
		0.95-1.45	10		10	50	16	BLA020	20
		1.4-2.1	10		10	50	20	BLA030	30
		1.7-2.6	10		10	50	20	BLA030	30
		2.2-3.4	10		10	50	20	BLA030	30
		2.8-4.2	10		10	50	20	BLA030	30
		4-6	10		10	50	20	BLA030	30
		5-7.5	10	BW125JAG, BW125RAG	30	50	20	BLA030	30
		6-9	10	EW125JAG, EW125RAG	30	50	20	BLA030	30
SK12	TK12	0.34-0.52	10	BW32SAG EW32SAG	3	50	2	BLA003	3
		0.48-0.72	10		3	50	4	BLA005	5
		0.64-0.96	10		5	50	4	BLA005	5
		0.8-1.2	10		5	50	4	BLA005	5
		0.95-1.45	10		10	50	16	BLA020	20
		1.4-2.1	10		10	50	20	BLA030	30
		1.7-2.6	10		10	50	20	BLA030	30
		2.2-3.4	10		10	50	20	BLA030	30
		2.8-4.2	10		10	50	20	BLA030	30
		4-6	10		10	50	20	BLA030	30
		5-7.5	10	BW125JAG, BW125RAG	30	50	20	BLA030	30
		6-9	10	EW125JAG, EW125RAG	30	50	20	BLA030	30
		7-10.5	10		30	50	20	BLA030	30
		9-13	10		30	50	20	BLA030	30

Mini-Contactors

SK Series

Protective Coordination

■ UL approved Short-circuit Current Ratings (SCCR)

● Combination of Breaker and Fuse

Magnetic Starter			Short-circuit Current Ratings (SCCR)				
Magnetic Contactor		Thermal Overload Relay	240V AC			600V AC	
Type	Type	Ampere setting range [A]	SCCR [kA]	Circuit breaker Max. rated current [A]	UL489-certified FUJI Automatic Breaker / Earth Leakage Circuit Breaker	SCCR [kA]	Current-limiting fuse Max. rated current [A]
SK06	TK12	0.1-0.15	25	15	BW125JAGU, BW125RAGU EW125JAGU, EW125RAGU	5	30
		0.13-0.2	25	15		5	30
		0.18-0.27	25	15		5	30
		0.24-0.36	25	15		5	30
		0.3-0.45	25	15		5	30
		0.34-0.52	25	15		5	30
		0.48-0.72	25	15		5	30
		0.64-0.96	25	15		5	30
		0.8-1.2	25	15		5	30
		0.95-1.45	25	15		5	30
		1.4-2.1	25	20		5	30
		1.7-2.6	25	20		5	30
		2.2-3.4	25	20		5	30
		2.8-4.2	25	20		5	30
SK09	TK12	0.1-0.15	25	15	BW125JAGU, BW125RAGU EW125JAGU, EW125RAGU	5	30
		0.13-0.2	25	15		5	30
		0.18-0.27	25	15		5	30
		0.24-0.36	25	15		5	30
		0.3-0.45	25	15		5	30
		0.34-0.52	25	15		5	30
		0.48-0.72	25	15		5	30
		0.64-0.96	25	15		5	30
		0.8-1.2	25	15		5	30
		0.95-1.45	25	15		5	30
		1.4-2.1	25	20		5	30
		1.7-2.6	25	20		5	30
		2.2-3.4	25	20		5	30
		2.8-4.2	25	20		5	30
SK12	TK12	0.1-0.15	25	15	BW125JAGU, BW125RAGU EW125JAGU, EW125RAGU	5	30
		0.13-0.2	25	15		5	30
		0.18-0.27	25	15		5	30
		0.24-0.36	25	15		5	30
		0.3-0.45	25	15		5	30
		0.34-0.52	25	15		5	30
		0.48-0.72	25	15		5	30
		0.64-0.96	25	15		5	30
		0.8-1.2	25	15		5	30
		0.95-1.45	25	15		5	30
		1.4-2.1	25	20		5	30
		1.7-2.6	25	20		5	30
		2.2-3.4	25	20		5	30
		2.8-4.2	25	20		5	30
SK06	-	-	25	30	BW125JAGU, BW125RAGU EW125JAGU, EW125RAGU	5	30
SK09	-	-	25	30	BW125JAGU, BW125RAGU EW125JAGU, EW125RAGU	5	30
SK12	-	-	25	30		5	30

● Combinations with Manual Motor Starter

Magnetic Contactor type	AC480Y/277V		Short-circuit Current Rating (SCCR) [kA]
	Combined MMS		
	Type	Ampere setting range [A]	
SK06	BM3RS□-P40	0.25-0.4	65
	BM3RS□-P63	0.4-0.63	65
	BM3RS□-001	0.63-1	65
	BM3RS□-1P6	1-1.6	65
	BM3RS□-2P5	1.6-2.5	50
	BM3RS□-004	2.5-4	50
	BM3RS□-6P3	4-6.3	50
	BM3RH□-P40	0.25-0.4	65
	BM3RH□-P63	0.4-0.63	65
	BM3RH□-001	0.63-1	65
	BM3RH□-1P6	1-1.6	65
	BM3RH□-2P5	1.6-2.5	65
	BM3RH□-004	2.5-4	65
	BM3RH□-6P3	4-6.3	65
SK09	BM3RS□-P40	0.25-0.4	65
	BM3RS□-P63	0.4-0.63	65
	BM3RS□-001	0.63-1	65
	BM3RS□-1P6	1-1.6	65
	BM3RS□-2P5	1.6-2.5	50
	BM3RS□-004	2.5-4	50
	BM3RS□-6P3	4-6.3	50
	BM3RS□-010	6.3-10	25
	BM3RH□-P40	0.25-0.4	65
	BM3RH□-P63	0.4-0.63	65
	BM3RH□-001	0.63-1	65
	BM3RH□-1P6	1-1.6	65
	BM3RH□-2P5	1.6-2.5	65
	BM3RH□-004	2.5-4	65
BM3RH□-6P3	4-6.3	65	
BM3RH□-010	6.3-10	25	
SK12	BM3RS□-P40	0.25-0.4	65
	BM3RS□-P63	0.4-0.63	65
	BM3RS□-001	0.63-1	65
	BM3RS□-1P6	1-1.6	65
	BM3RS□-2P5	1.6-2.5	50
	BM3RS□-004	2.5-4	50
	BM3RS□-6P3	4-6.3	50
	BM3RS□-010	6.3-10	25
	BM3RS□-013	9-13	25
	BM3RH□-P40	0.25-0.4	65
	BM3RH□-P63	0.4-0.63	65
	BM3RH□-001	0.63-1	65
	BM3RH□-1P6	1-1.6	65
	BM3RH□-2P5	1.6-2.5	65
BM3RH□-004	2.5-4	65	
BM3RH□-6P3	4-6.3	65	
BM3RH□-010	6.3-10	25	
BM3RH□-013	9-13	10	

Mini-Contactors

SK Series

Normal Operating Conditions and Mounting

■ Normal Operating Conditions and Correct Mounting

● Standard Operating Conditions

Ambient temperature *1	-10 to 55°C with no sudden temperature changes resulting in condensation or icing (The average temperature over a 24-hour period must not exceed 35°C.)
Ambient humidity	45% to 85% RH (with no condensation)
Altitude	2,000 m max.
Atmosphere	No excessive dust, smoke, corrosive gasses, inflammable gases, steam, or salts
Storage temperature	-40 to 60°C
Vibration resistance	10 to 55Hz, 15m/s ²
Shock resistance	50m/s ²
Mounting	Screw mounting 35mm-wide top hat rail (Refer to the rail mounting in the next item.)

Mounting angle

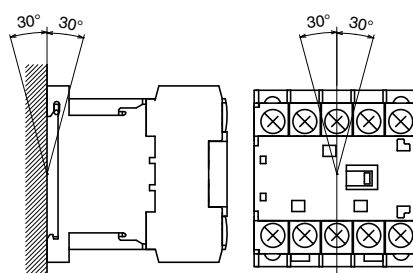

Mounting gaps *2

Provide the mounting gaps and arc space that are given in the following table when you mount the product.

A[mm]	B[mm]	C[mm]
0	10	2

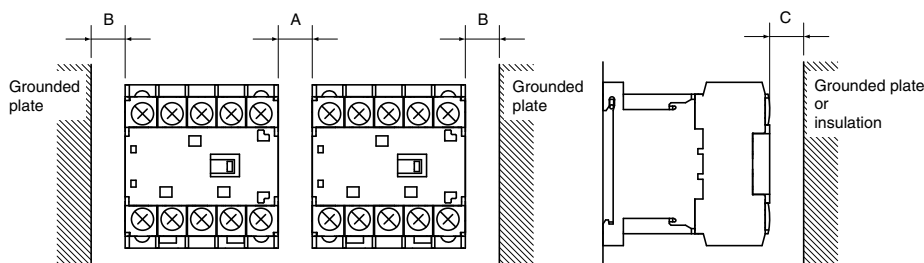

Note *1: The ambient temperature is the temperature near the product during operation.

Note *2: If Magnetic Starters are used in combination with Thermal Overload Relays and the products are used with continuous through current without providing gaps, temperature increases will reduce the life of the coil. Also, the characteristics of the Thermal Overload Relays will vary somewhat from the mutual thermal effects between the heaters. When using the products under these conditions, separate the products from each other by at least 5 mm (dimension A).

● Rail Mounting

The SK06 to SK12 Magnetic Motors and Starters can be mounted to 35mm-wide support rails. Secure the rail with the mounting pitch that is shown in the figure at the right.

Example of Applicable Rail: TH35-15AL

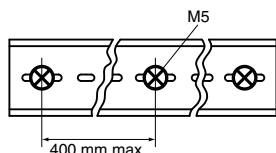

● Mounting Rail

Type	TH35-15AL
Material	Aluminum
External dimensions	

● Voltage Fluctuation Range in Control Circuits and Voltage Drop

● SK06 to SK12A (AC Operation)

Drop-out voltage (operating voltage): 85% to 110% of rated voltage
However, there is an official rated inrush voltage, but usage is possible without contact welding even if the voltage drops to 75% of the rating when the main contacts close.

● SK06 to SK12G, L-shape Drop (DC Operation)

Drop-out voltage (operating voltage): 85% to 110% of rated voltage at ambient temperature of 55°C and 80% to 110% of rated voltage at ambient temperature of 40°C.

However, there is an official rated inrush voltage, but usage is possible without contact welding even if the voltage drops to 75% of the rating when the main contacts close.

■ Wiring

● Wiring and Terminal Processing

Make all connections correctly according to the connection diagram. For the SK06 to SK12, you can use solid wires, stranded wires, or crimped terminals for the main terminals, auxiliary terminals, and coil terminals.

● Tightening Torque

If the Magnetic Contactor or Switch is not mounted completely, the shock when the Contactor or Switches is turned ON may cause the contacts to jump or may reduce the durability. Also, if wires are not tightened sufficiently, they may become hot or loose, resulting in a fire, short-circuit, electric shock or some other potentially dangerous situation. Be sure to tighten the wires to the torque that is specified in the following table.

● Terminals, Wire Sizes, and Tightening Torque

1) Terminals can be wired with solid wires, stranded wires, or crimped terminals can be used to connect the terminals. To use round crimped terminals, remove the terminal cover before you connect them to the terminals.

2) The connectable wire sizes and tightening torque are given in the following table.

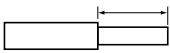
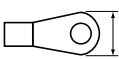
		Main terminals	Control and auxiliary terminals	
Direct connection	Solid wire	[mm]	1 wire (1.2 to 2mm dia.) 2 wires (1.2 to 1.6mm dia.) 2 wires (1.6 to 2mm dia.)	
		[AWG]	1 wire x (16 to 12) 2 wires x (16 to 14) 2 wires x (14 to 12)	
	Stranded wires	[mm ²]	1 wire x (0.75 to 2.5) 2 wires x (0.75 to 1.5) 2 wires x (1.5 to 2.5)	
		[AWG]	1 wire x (18 to 14) 2 wires x (18 to 16) 2 wires x (16 to 14)	
	Sheath stripping length [mm]		10	
	Flexible stranded wires with sleeves	[mm ²]	1 wire x (0.75 to 2.5) 2 wires x (0.75 to 1.5) 2 wires x (1.5 to 2.5)	
[AWG]		1 wire x (18 to 14) 2 wires x (18 to 16) 2 wires x (16 to 14)		
Sleeve length [mm]		10		
Terminal connection	Stranded wires or flexible stranded wires	[mm ²]	0.75 to 4	0.75 to 2.5
		[AWG]	18 to 10	18 to 14
	Largest crimped terminal [mm]		7.7	
Terminal screw size		M3.5		
Tightening tool		Phillips H2 screwdriver Flat-blade screwdriver, 1x5.5xL, type B		
Flat-blade screwdriver, 1x5.5xL, type B		[N·m]	0.8 to 1.0	

Note 1. Flexible stranded wires without sleeves cannot be used. Attach sleeves before connecting the wires.

- 0.75 to 4mm² (AWG 18 to 12) stranded wire: 7 strands or less
- Flexible stranded wire: More strands than given above.

Note 2. Use DIN 46228-compliant sleeves.

- For 1.5 to 2.5mm² (AWG 16 to 14) wires, use sleeves without insulating sheaths.
- You will not be able to insert the sleeves for some crimping tools. Use a Phoenix Contact CRIMPFOX 6 crimping tool or the equivalent.
- Observe manufacture instructions on the wire sheath stripping lengths.

Note 3. For compliance with UL or CSA standards, you must use AWG 14 or 12 wires. Also, you must use solid wires, or use stranded or flexible stranded wires with crimped terminals or sleeves.

Note 4. Two crimped terminals can be connected.

Note 5. Do not connect anything to terminals that are not wired.

Note 6. After you bend or otherwise arrange the connected wires after wiring, make sure that the tightening torque is still correct.

Note 7. If 18 A or higher will continuously flow through a Magnetic Contactor in an environment that exceeds 40°C, wiring with 4mm² or AWG 12 wires.

Mini-Contactors

SK Series

Handling

● Handling Thermal Overload Relays

1) Adjusting the Current [Figure 1]

Turn the adjustment dial within the scale so that the total load current of the motor aligns with the triangle mark. Performance may not be dependable if the dial is set outside of the range of the scale.

2) Operation Indication [Figure 1]

When the Thermal Overload Relay operates, the white trip indicator will disappear in the operation indication window. (The white indicator will not be hidden if the Thermal Overload Relay is tripped in auto-reset status.)

3) Sequence Check [Figure 1]

You can perform a sequence check by pressing the white trip indicator in the direction of the arrow.

4) Reset Method [Figure 1]

When the Thermal Overload Relay operates, remove the cause of the error (e.g., an overload) and then press the reset button. (The Thermal Overload Relay will not reset unless it has cooled sufficiently.)

5) Auto-reset Status and Two-wire Circuits

If the Thermal Overload Relay is in auto-reset status for a 2-wire circuit and the Thermal Overload Relay resets automatically, the motor will restart operation automatically. Take adequate precautions for this.

6) Changing between Manual Resetting and Auto Resetting [Figure 2]

Use the following procedure to change between manual resetting and auto resetting. Reverse the procedure to change between auto resetting and manual resetting.

- ① Open the front cover.
- ② Use a screwdriver or similar device to press the reset button and turn it 90° clockwise.
- ③ Make sure that the reset button remains in the pressed state.
- ④ Close the front cover.

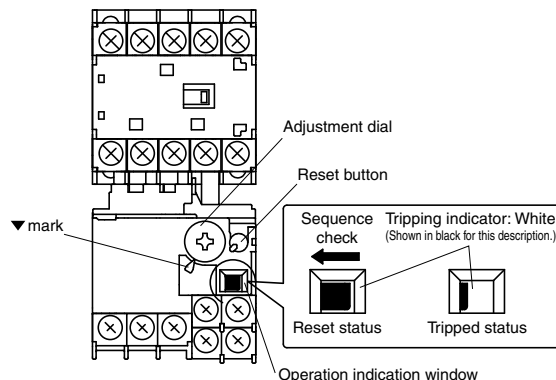

Figure 1

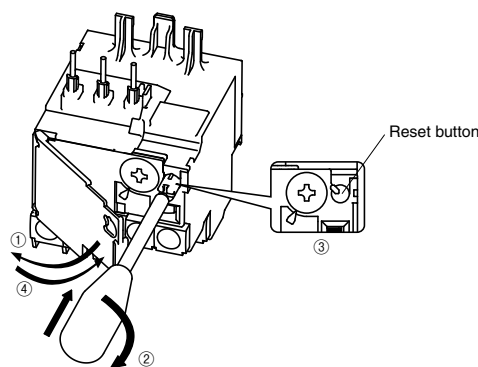
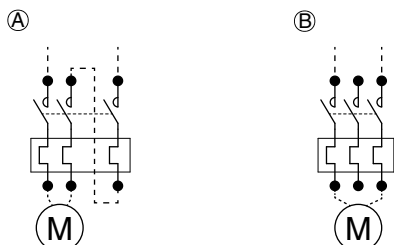

Figure 2

● Application in Single-phase Motor Circuits and DC Motor Circuits

The TK12 Thermal Overload Relays are equipped with open-phase protection. If current does not flow on all phases, the reduced operating current may cause the TK12 to operate unnecessarily. If you use the TK12 in a single-phase motor circuit or DC motor circuit, perform either (A) or (B).

- (A) Connect the wiring so that series current flows to all of the poles.
- (B) Set the adjustment dial to a setting that is 5% to 10% higher than normal.



● Ambient Temperature Compensation Characteristics

Changes in the ambient environment will affect the operation of the Thermal Overload Relay. The operational current will be higher at lower temperatures and lower at higher temperatures, i.e., compensation of operating characteristics will not be complete. Adjust the current according to the application environment.

The compensation coefficient for adjusting the current depends on the ambient temperature, as shown in Figure 3. If the ambient temperature in the application changes greatly, e.g., by 20°C, use the following example as a guide to calculate the adjusted current value after compensation.

Example: Calculation Method for Dial Adjustment
at an Ambient Temperature of 55°C

$$\frac{\text{Dial current at } 20^{\circ}\text{C}}{\text{Compensation coefficient at ambient temperature of } 55^{\circ}\text{C}} = \text{Dial current at ambient temperature of } 55^{\circ}\text{C}$$

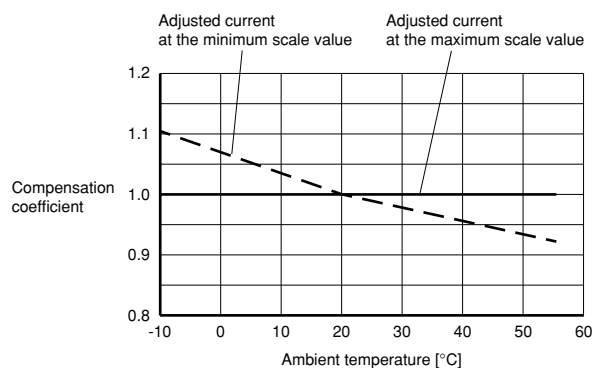

Figure 3

● Mounting the Thermal Overload Relay to and Removing It from the Magnetic Contactor

I. Mounting [Figure 4]

- 1) Loosen terminals 2, 4, and 6 on the Magnetic Contactor.
- 2) Insert the posts on the Thermal Overload Relay into the holes on the Magnetic Contactor in the direction shown by the arrows.
- 3) Insert the main circuit section of the Thermal Overload Relay on the right sides of the terminal screws.
- 4) Tighten the terminal screws on the Magnetic Contactor to the specified torque.

II. Removing [Figure 4]

- 1) Loosen the terminals screws on the Magnetic Contactor.
- 2) Move the Thermal Overload Relay left and right and pull it free from the Magnetic Contactor.

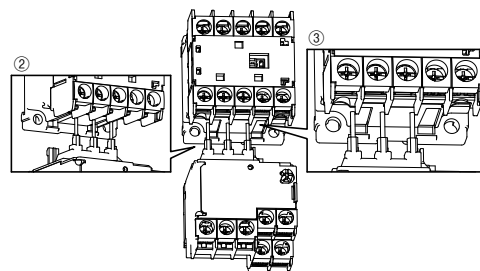

Figure 4

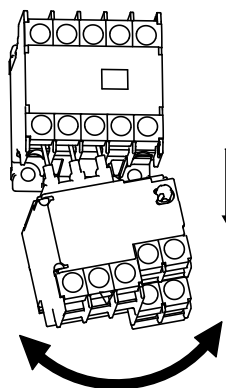

Figure 5

Mini-Contactors

SK Series

Magnetic Contactors

Magnetic Contactors

■ Features

- International safety standards for standard models (IEC, GB, JIS, UL, and CSA).
- Models available with AC or DC operating coils (DC: 2.4W and 1.2W models only).
- Many optional units.
 - Auxiliary Contact Blocks (2-pole or 4-pole)
 - Coil Surge Suppression Units
 - Interlock Units
- Easier Thermal Overload Relay wiring.
The terminal arrangement separates main circuit wires and auxiliary circuit wires for easier wiring.



SK12L

■ Ordering Information (Types)

● Magnetic Contactors

SK 06 A H - E 10
① ② ③ ④ ⑤ ⑥

- ① Series
- ② Frame size
- ③ Operating coil specification
- ④ Auxiliary contact specification
- ⑤ Coil voltage specification
- ⑥ Auxiliary contact arrangement

■ Ratings and Types

● Magnetic Contactors

Frame size ②	Max. motor capacity [kW]			Rated operational current [A]			Conventional free air thermal current [A] (Rated thermal current)	Operating coil specification ③	Auxiliary contact specification ④	Auxiliary contact arrangement ⑥	Type
	3-phase squirrel-cage motor (AC-3)			3-phase squirrel-cage motor (AC-3)							
	200-240V	380-440V	500-550V	200-240V	380-440V	500-550V					
6A [06]	1.5	2.2	3	6	6	5	20	AC-operated [A]	Bifurcated [blank] Single [H]	1NO [10] 1NC [01]	SK06A-□▲
								DC-operated (2.4W) [G]	Bifurcated [blank] Single [H]		SK06AH-□▲
								DC-operated (1.2W) [L]	Bifurcated [blank] Single [H]		SK06G-□▲ SK06GH-□▲ SK06L-□▲ SK06LH-□▲
9A [09]	2.2	4	4	9	9	7		AC-operated [A]	Bifurcated [blank] Single [H]		SK09A-□▲
								DC-operated (2.4W) [G]	Bifurcated [blank] Single [H]		SK09AH-□▲
								DC-operated (1.2W) [L]	Bifurcated [blank] Single [H]		SK09G-□▲ SK09GH-□▲ SK09L-□▲ SK09LH-□▲
12A [12]	3	5.5	5.5	12	12	9		AC-operated [A]	Bifurcated [blank] Single [H]		SK12A-□▲
								DC-operated (2.4W) [G]	Bifurcated [blank] Single [H]		SK12AH-□▲
								DC-operated (1.2W) [L]	Bifurcated [blank] Single [H]		SK12G-□▲ SK12GH-□▲ SK12L-□▲ SK12LH-□▲

Note 1. "□" in the type column is replaced with the coil voltage code.

Note 2. Numbers and letters in brackets [] are used in the product code.

● Coil voltage ⑤

AC-operated	Order Voltage	24	48	100	110	120	200	220	240	380	400	440	500
	Product code	E	F	1	H	K	2	M	P	S	4	T	5
DC-operated (2.4W)	Order Voltage	12	24	48	60	100	110	120	200	210	220		
	Product code	B	E	F	G	1	H	K	2	Y	M		
DC-operated (1.2W)	Order Voltage	12	24	48									
	Product code	B	E	F									

Mini-Contactors SK Series Magnetic Contactors

■ Dimensions, mm

- Magnetic Contactors
SK06□, SK09□, SK12□

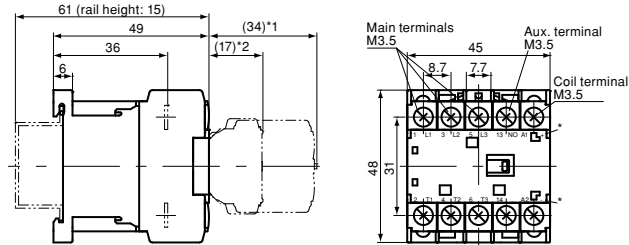

[NOTES]
*1 With SZ1KA□ Auxiliary Contact Blocks.
*2 With SZ1FA□ Auxiliary Contact Blocks.

Mounting Hole Dimensions

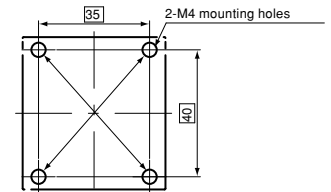

[NOTE]
Mount the Auxiliary Overload Relay with two mounting holes in diagonally opposed corners.

Mass : 0.14kg (For AC-operated models.)
0.17kg (For DC-operated models.)

Wiring diagram

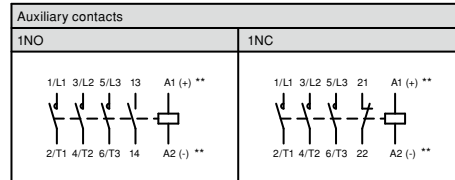

** For DC-operated models.

- Magnetic Starters (reference)
SK□ + TK12

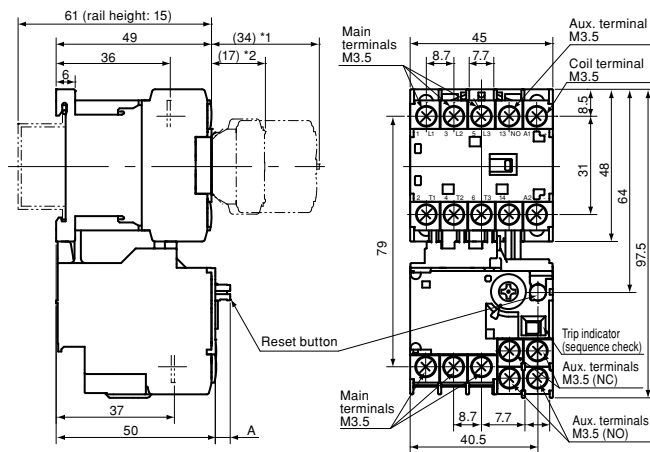

Dimension A
- Manually reset state: 5mm
- Automatically reset state: 2mm

[NOTES]
*1 With SZ1KA□ Auxiliary Contact Blocks.
*2 With SZ1FA□ Auxiliary Contact Blocks.

Mounting Hole Dimensions

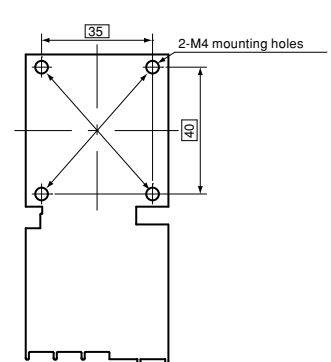

[NOTE]
Mount the Auxiliary Overload Relay with two mounting holes in diagonally opposed corners.

Mass : 0.24kg (AC-operated model)
0.27kg (DC-operated model)

Wiring diagram

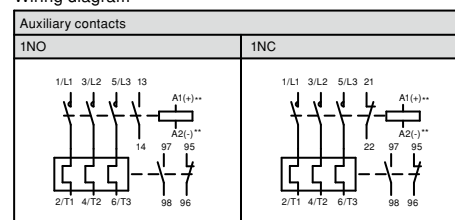

** For DC-operated models.

Mini-Contactors

SK Series

Reversing Magnetic Contactors

Reversing Magnetic Contactors

■ Features

- Ideal for forward/reverse motor operation and plugging.
- Mechanical interlock provided as a standard feature.

■ Ordering Information (Types)

- Reversing Magnetic Contactors

SK 06 A H R - E 10 W
 ① ② ③ ④ ⑤ ⑥ ⑦ ⑧

- ① Series
- ② Frame size
- ③ Operating coil specification
- ④ Auxiliary contact specification
- ⑤ Reversing
- ⑥ Coil voltage specification
- ⑦ Auxiliary contact arrangement
- ⑧ Reversing connection



SK12AR

■ Ratings and Types

- Reversing Magnetic Contactors

Frame size ②	Max. motor capacity [kW]			Rated operational current [A]			Conventional free air thermal current [A] (Rated thermal current)	Operating coil specification ③	Auxiliary contact specification ④	Auxiliary contact arrangement ⑦	Type
	3-phase squirrel-cage motor (AC-3)			3-phase squirrel-cage motor (AC-3)							
	200-240V	380-440V	500-550V	200-240V	380-440V	500-550V					
6A [06]	1.5	2.2	3	6	6	5	20	AC-operated [A]	Bifurcated [blank]	1NO [10] 1NC [01]	SK06AR-□▲W SK06AHR-□▲W SK06GR-□▲W SK06GHR-□▲W SK06LR-□▲W SK06LHR-□▲W
									Single [H]		
								DC-operated (2.4W) [G]	Bifurcated [blank]		
9A [09]	2.2	4	4	9	9	7		DC-operated (1.2W) [L]	Bifurcated [blank]		SK09AR-□▲W SK09AHR-□▲W SK09GR-□▲W SK09GHR-□▲W SK09LR-□▲W SK09LHR-□▲W
									Single [H]		
								AC-operated [A]	Bifurcated [blank]		
12A [12]	3	5.5	5.5	12	12	9		DC-operated (2.4W) [G]	Bifurcated [blank]		SK12AR-□▲W SK12AHR-□▲W SK12GR-□▲W SK12GHR-□▲W SK12LR-□▲W SK12LHR-□▲W
									Single [H]		
								DC-operated (1.2W) [L]	Bifurcated [blank]		

Note 1. "□" in the type column is replaced with the coil voltage code.

Note 2. Numbers and letters in brackets [] are used in the product code.

Note 3. An electrical interlock is not implemented on Magnetic Contactors with an auxiliary contact arrangement of 1NOx2. When using these Magnetic Contactors, always implement an electrical interlock in the external control circuits to prevent short-circuit faults when power is turned ON.

Note 4. An electrical interlock is implemented in the auxiliary circuit configurations of the Magnetic Contactor. If you need to use an auxiliary contact, add an option Auxiliary Contact Blocks.

- Coil voltage ⑥

AC-operated	Order Voltage	24	48	100	110	120	200	220	240	380	400	440	500
	Product code	E	F	1	H	K	2	M	P	S	4	T	5
DC-operated (2.4W)	Order Voltage	12	24	48	60	100	110	120	200	210	220		
	Product code	B	E	F	G	1	H	K	2	Y	M		
DC-operated (1.2W)	Order Voltage	12	24	48									
	Product code	B	E	F									

Mini-Contactors SK Series Reversing Magnetic Contactors and Magnetic Starters

■ Dimensions, mm

- Magnetic Contactors
SK06□R, SK09□R, SK12□R

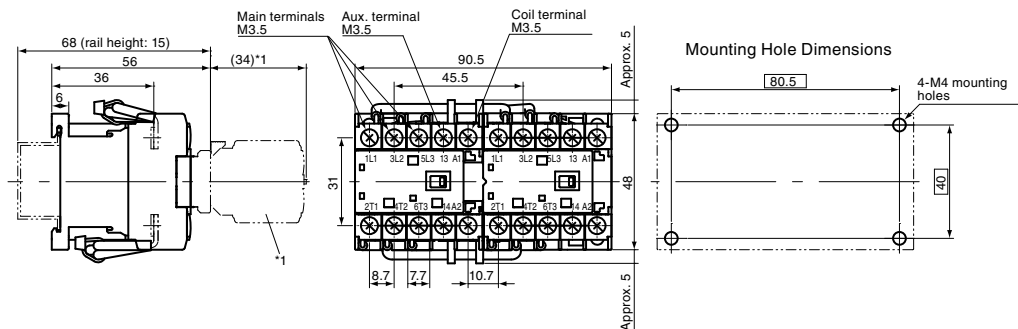

Wiring diagram

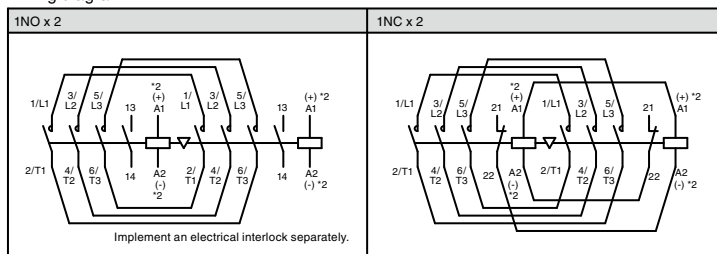

Mass : 0.32kg (AC-operated model)
0.38kg (DC-operated model)

[NOTE]
*1 With Auxiliary Contact Blocks.
*2 For DC-operated models.

- Magnetic Starters (reference)
SK□R + TK12

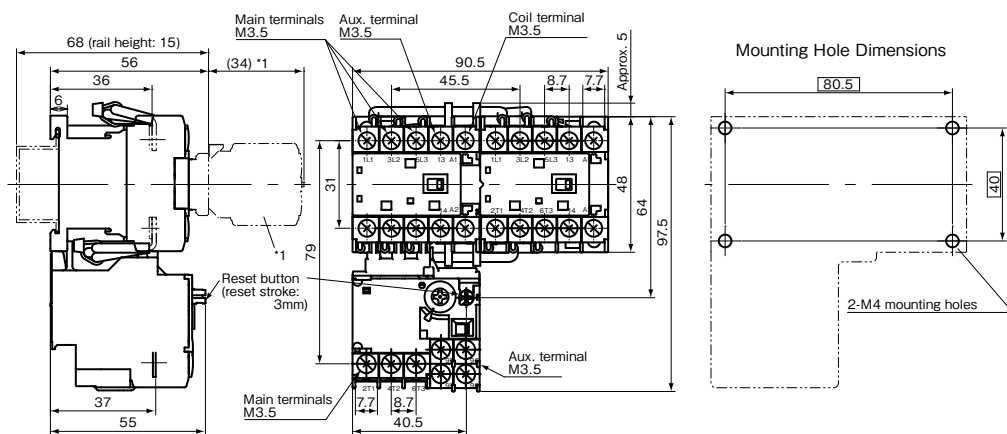

Wiring diagram

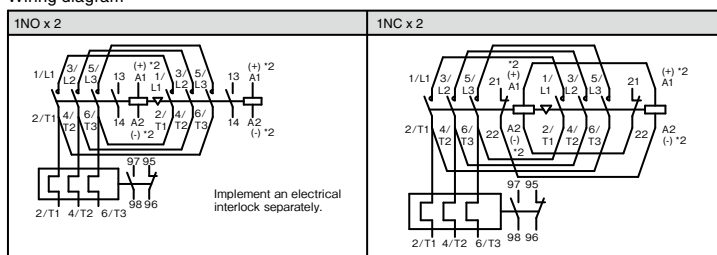

Mass : 0.42kg (AC-operated model)
0.48kg (DC-operated model)

[NOTE]
*1 With Auxiliary Contact Blocks.
*2 For DC-operated models.

Mini-Contactors

SK Series

Thermal Overload Relay

Thermal Overload Relay

■ Features

- International safety standards for standard models (IEC, GB, JIS, UL, and CSA).
- A terminal cover and dial cover are provided as standard features.
- Highly reliable 1NO1NC isolated auxiliary contacts to enable using NC and NO contacts at different potentials.
- Easily switch between manual and automatic reset.
- Parallel arrangement of main terminals and auxiliary terminals for easier wiring.



TK12

■ Ordering Information (Types)

- Thermal Overload Relay

TK 12 W A - 009

① ② ③ ④ ⑤

- ① Type
- ② Frame size
- ③ Mounting
- ④ Reset method
- ⑤ Ampere setting range *

* Refer to Heat Element Rating Specification Codes.

■ Ratings and Types

Type
TK12W□-■■■■

Note. "□" in the type column is replaced with the reset method code.
"■■■■" is replaced by the specified code for the current setting range.

■ Ampere Setting Range Specification Codes

Ampere setting range [A]	Code	Applicable Magnetic Contactors		
0.1 - 0.15	P10	SK06	SK09	SK12
0.13 - 0.2	P13			
0.18 - 0.27	P18			
0.24 - 0.36	P24			
0.34 - 0.52	P34			
0.48 - 0.72	P48			
0.64 - 0.96	P64			
0.8 - 1.2	P80			
0.95 - 1.45	P95			
1.4 - 2.1	1P4			
1.7 - 2.6	1P7			
2.2 - 3.4	2P2			
2.8 - 4.2	2P8			
4 - 6	004			
5 - 7.5	005			
6 - 9	006			
7 - 10.5	007			
9 - 13	009			

■ **Auxiliary Circuit Ratings**

● Ratings for IEC Standard Compliance

Type	Conventional free air thermal current [A] (Rated continuous current)	Rated operational current [A]					Minimum voltage and current
		Rated operational voltage [V]	AC-15 (Ind. load)		DC-13 (Ind. load)		
			NC contacts	NO contacts	NC contacts	NO contacts	
TK12	5	24	3 (0.5)	3 (0.5)	1.1(0.3)	1.1 (0.3)	DC5V, 3mA
		100-120	2.5 (0.5)	2.5 (0.5)	0.28	0.28	
		200-240	2 (0.5)	1.5 (0.5)	0.14	0.14	
		380-440	1 (0.5)	0.75 (0.5)	–		
		500-600	0.6 (0.5)	0.6 (0.5)	–		

Numbers in brackets () are for automatic reset.

● Ratings for UL and CSA Standard Compliance

Type	Rated continuous current [A]	Rated operational current [A]						Rating code	
		AC			DC			AC	DC
		Rated operational voltage [V]	Making	Breaking	Rated operational voltage [V]	Making	Breaking		
TK12	5	120	30	3	125	0.22	0.22	B600	R300
		240	15	1.5					
		480	7.5	0.75	250	0.11	0.11		
		600	6	0.6					

■ **Operating Characteristics (Specifications)**

● 3-pole Circuits

Standard	Operating limit		Overload (hot start)	Locked rotor (cold start)	Ambient temperature
	Non-tripping	Tripping			
IEC 60947-4-1	105% I _e (for less than 2h)	120% I _e (for less than 2h)	Tripping class 10A: 150% I _e for less than 2min	Tripping class 10A: 720% I _e for 2 to 10 s max.	20°C

● 2-pole Circuits

Standard	Phase-loss protection	Non-tripping	Operation (hot start)	Ambient temperature
IEC 60947-4-1	Provided.	2-pole: 100% I _e 1-pole: 90% I _e	{ 2-pole: 115% I _e (for less than 2h) 1-pole: 0% I _e	20°C

Mini-Contactors

SK Series

Thermal Overload Relay

■ Operating Characteristics Curves (Average Values)

- Tripping Class 10A

TK12 series, Ambient temperature: 20°C

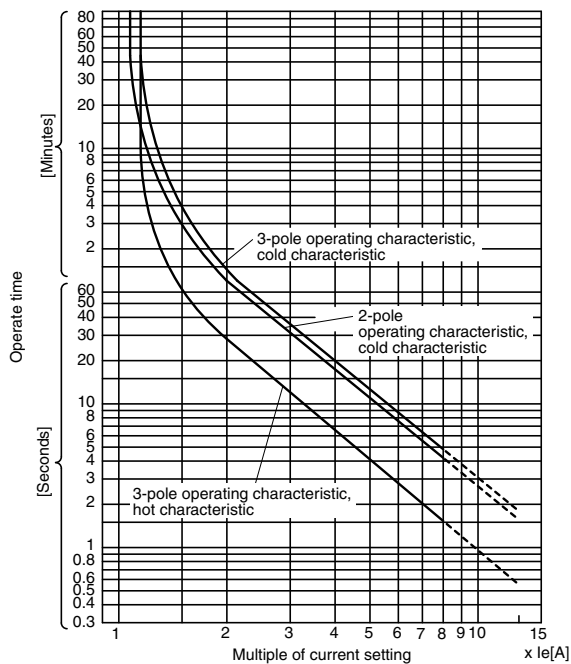

■ Dimensions, mm

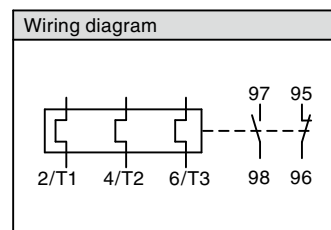
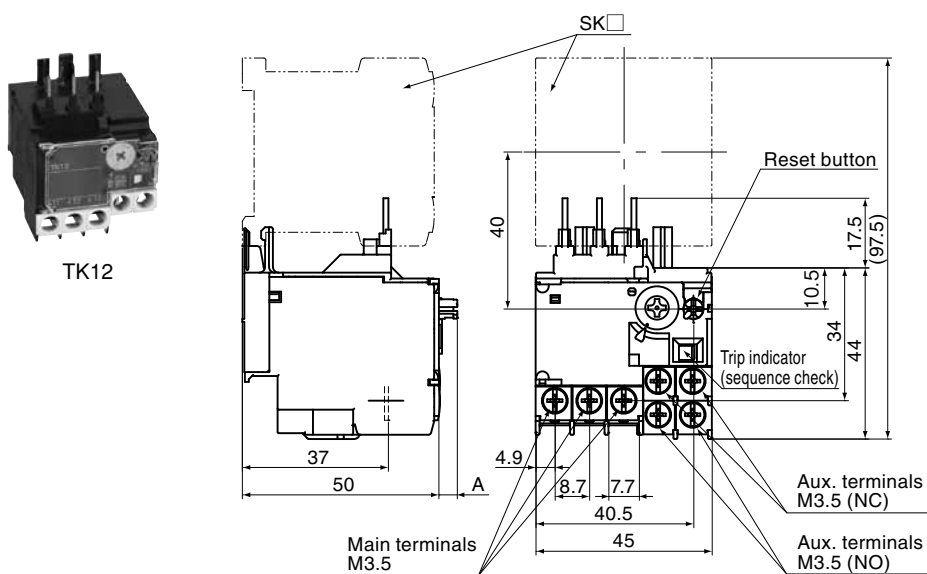

Mass : 0.1kg

Dimension A
 - Manually reset state: 5mm
 - Automatically reset state: 2mm

Optional unit

■ Type Numbers and Product Codes

Product name	Type	Specification	Used with
Auxiliary Contact Blocks (Front mounting, Bifurcated Contact)	SZ1KA40	Contact arrangement: 4NO	SK06 to SK12 *1 SKH4 *1
	SZ1KA31	Contact arrangement: 3NO+1NC	
	SZ1KA22	Contact arrangement: 2NO+2NC	
	SZ1KA13	Contact arrangement: 1NO+3NC	
	SZ1KA04	Contact arrangement: 4NC	SK06 to SK12 SKH4
	SZ1KA20	Contact arrangement: 2NO	
	SZ1KA11	Contact arrangement: 1NO+1NC	
	SZ1KA02	Contact arrangement: 2NC	
Auxiliary Contact Blocks (Front mounting, Single Button Contact)	SZ1KA40H	Contact arrangement: 4NO	SK06 to SK12 *1 SKH4 *1
	SZ1KA31H	Contact arrangement: 3NO+1NC	
	SZ1KA22H	Contact arrangement: 2NO+2NC	
	SZ1KA13H	Contact arrangement: 1NO+3NC	
	SZ1KA04H	Contact arrangement: 4NC	SK06 to SK12 SKH4
	SZ1KA20H	Contact arrangement: 2NO	
	SZ1KA11H	Contact arrangement: 1NO+1NC	
	SZ1KA02H	Contact arrangement: 2NC	
Auxiliary Contact Blocks (Small Front mounting, Bifurcated Contact)	SZ1FA11	Contact arrangement: 1NO+1NC	SK06 to SK12 SKH4
Auxiliary Contact Blocks (Small Front mounting, Single Button Contact)	SZ1FA11H	Contact arrangement: 1NO+1NC	SK06 to SK12 SKH4
Mechanical Interlock Units	SZ1KRM	Reversing assembly and mechanical interlock	SK06 to SK12
Reversing Connection Kit (wiring)	SZ1KRW1W	Reversing Connection Kit for main circuit	SK06 to SK12
Main Circuit Surge Suppression Unit *2	SZ-ZM2	Built-in CR (3-phase motor, 200V, 0.1 to 2.2kw)	SK06 to SK12
Standalone Installation Unit *2 (for Main Circuit Surge Suppression Unit)	SZ-ZMH	For Main Circuit Surge Suppression Unit	SZ-ZM2
Coil Surge Suppression Units (surge suppression only)	SZ1KZ1	Built-in varistor: 24 to 48V AC/DC	SK06 to 12 SKH4
	SZ1KZ2	Built-in varistor: 48 to 125V AC/DC	
	SZ1KZ3	Built-in varistor: 100 to 240V AC/DC	
Coil Surge Suppression Units (with Operation Indicator Lamps)	SZ1KZ4	Built-in varistor and LED: 24 to 48V AC/DC	SK06 to SK12 SKH4
	SZ1KZ5	Built-in varistor and LED: 48 to 125V AC/DC	
Operation Indicator Units	SZ1KL1	Built-in LED: 12 to 24V AC/DC	SK06 to SK12 SKH4
	SZ1KL2	Built-in LED: 24 to 48V AC/DC	
	SZ1KL3	Built-in LED: 48 to 125V AC/DC	
Thermal Overload Relay Reset Releases	SZ-R1	Release length: 300mm	TK12
	SZ-R2	Release length: 500mm	
	SZ-R3	Release length: 700mm	
Link Module	BZ0LRK12AA	Links to Manual Motor Starter	SK06 to SK12
Reversing Connection Unit (Insert)	SZ1KRW1M	Reversing Connection Unit (Insert) for main circuit	SK06 to SK12

*1 These options cannot be used with 1.2W DC Magnetic Contactors and Starters from SK06 to SK12L and SKH4L Auxiliary Relays.

*2 Use the SZ-ZM2 Main Circuit Surge Suppression Unit together with the SZ-ZMH Standalone Installation Unit.

Mini-Contactors

SK Series

Auxiliary Contact Blocks

Auxiliary Contact Blocks

■ Features

- Easily add on auxiliary contacts.
- You can add auxiliary contacts without increasing the footprint to contribute to control panel downsizing.
- Many different contact variations in two external sizes.
- Models with double contacts are available for high reliability to achieve a minimum operating voltage and current of 5V DC, 3mA.

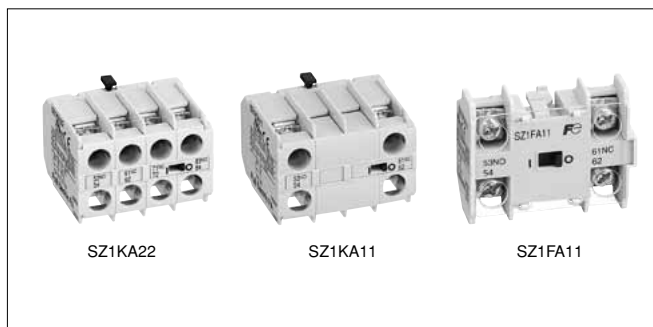

■ Ordering Information (Types)

- Auxiliary Contact Blocks

SZ1KA22

① Type

■ Ordering Information (Types)

Product name	Number of contacts	Contact arrangement	Mounting	Used with	Type	
Auxiliary Contact Blocks with Bifurcated Contacts	4	4NO	Front mounting	SK06 to SK12 *1 SKH4 *1	SZ1KA40	
		3NO+1NC			SZ1KA31	
		2NO+2NC			SZ1KA22	
		1NO+3NC			SZ1KA13	
		4NC			SZ1KA04	
	2	2NO	Front mounting	SK06 to SK12 SKH4	SZ1KA20	
		1NO+1NC			SZ1KA11	
		2NC			SZ1KA02	
	Auxiliary Contact Blocks with Single Contacts	4	4NO	Front mounting	SK06 to SK12 *1 SKH4 *1	SZ1KA40H
			3NO+1NC			SZ1KA31H
2NO+2NC			SZ1KA22H			
1NO+3NC			SZ1KA13H			
4NC			SZ1KA04H			
2		2NO	Front mounting	SK06 to SK12 SKH4	SZ1KA20H	
		1NO+1NC			SZ1KA11H	
		2NC			SZ1KA02H	
Small Auxiliary Contact Block with Bifurcated Contacts		2	1NO+1NC	Front mounting	SK06 to SK12 SKH4	SZ1FA11
Small Auxiliary Contact Block with Single Contacts		2	1NO+1NC	Front mounting	SK06 to SK12 SKH4	SZ1FA11H

*1These options cannot be used with 1.2W DC Magnetic Contactors and Starters from SK06 to SK12L and 1.2W SKH4L Auxiliary Relays.

■ Ratings

Type	Conventional free air thermal current (Rated continuous current) [A]	Making and breaking current (AC) [A]	Rated operational current [A]						Minimum voltage and current
			AC			DC			
			Rated operational voltage [V]	Ind. load (AC-15)	Res. load (AC-12)	Rated operational voltage [V]	Ind. load (DC-13)	Res. load (DC-12)	
SZ1KA□ SZ1FA□ (Bifurcated contacts)	10	30	AC100 - 120	3	6	24 DC	2	3	5V DC, 3mA
		30	AC200 - 240	3	6	48 DC	1	2	
		10	AC380 - 440	1	6	110 DC	0.3	1.5	
		5	AC500 - 600	0.5	3	220 DC	0.2	0.5	
SZ1KA□H SZ1FA□H (Single contacts)	10	60	AC100 - 120	6	10	24 DC	4	8	24V DC, 10mA
		60	AC200 - 240	6	10	48 DC	1	3.5	
		60	AC380 - 440	6	10	110 DC	0.5	2.5	
		30	AC500 - 600	3	5	220 DC	0.25	0.8	

Mini-Contactors SK Series Auxiliary Contact Blocks

■ Dimensions, mm

- SZ1KA40
- SZ1KA31
- SZ1KA22
- SZ1KA13
- SZ1KA04
- SZ1KA40H
- SZ1KA31H
- SZ1KA22H
- SZ1KA13H
- SZ1KA04H

4-pole

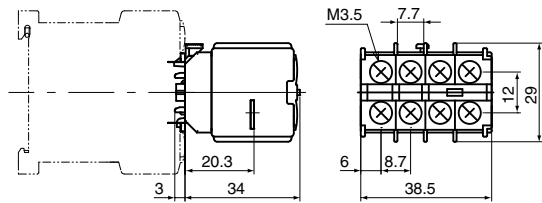

Mass : 34g

Type	Contact arrangement
SZ1KA40 SZ1KA40H	4NO
SZ1KA31 SZ1KA31H	3NO+1NC
SZ1KA22 SZ1KA22H	2NO+2NC
SZ1KA13 SZ1KA13H	1NO+3NC
SZ1KA04 SZ1KA04H	4NC

- SZ1KA20
- SZ1KA11
- SZ1KA02
- SZ1KA20H
- SZ1KA11H
- SZ1KA02H

2-pole

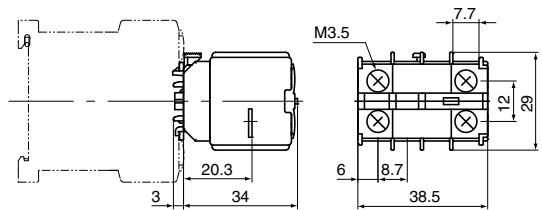

Mass : 29g

Type	Contact arrangement
SZ1KA20 SZ1KA20H	2NO
SZ1KA11 SZ1KA11H	1NO+1NC
SZ1KA02 SZ1KA02H	2NC

- SZ1FA11
- SZ1FA11H

Small,
2-pole

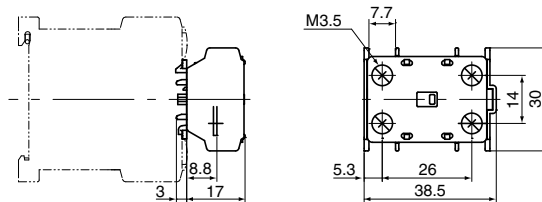

Mass : 17g

Type	Contact arrangement
SZ1FA11 SZ1FA11H	1NO+1NC

Mini-Contactors

SK Series

Mechanical Interlock Unit and Power Connection Kit for Reversing

Mechanical Interlock Unit and Power Connection Kit for Reversing

■ Features

- Mechanically prevent two Magnetic Contactors from turning ON at the same time.
- Combine a Reversing Connection Kit with an Interlock Unit to easily configure a reversing Magnetic Contactors.
- Mounting two Magnetic Contactors on the front surface reduces the mounting footprint and contributes to downsizing control panels.

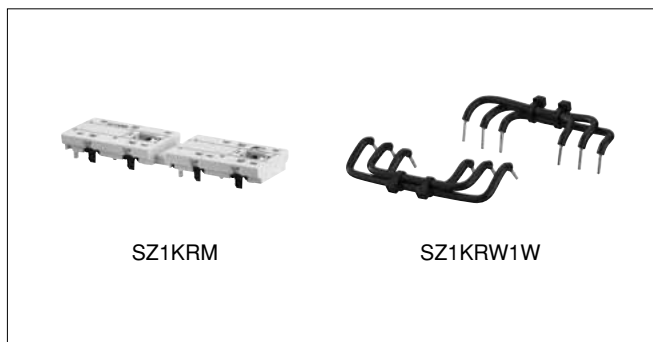

■ Types

- Mechanical Interlock Unit: Joins two Magnetic Contactors to mechanically lock them.

Product name	Used with	Type
Mechanical Interlock Unit	SK06, SK09, and SK12	SZ1KRM

- Power Connection Kit for Reversing: Used to reverse the circuit wiring between the main circuit terminals.

Product name	Wire size	Number of conductors per set	Used with	Type
Power Connection Kit for Reversing	AWG14 (1.6 dia.)	<ul style="list-style-type: none"> • One set for power supply side • One set for load side 	SK06, SK09, and SK12	SZ1KRW1W

■ Dimensions, mm

- Mechanical Interlock Unit

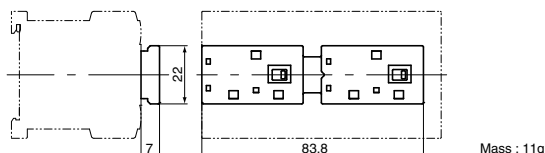

- Power Connection Kit for Reversing

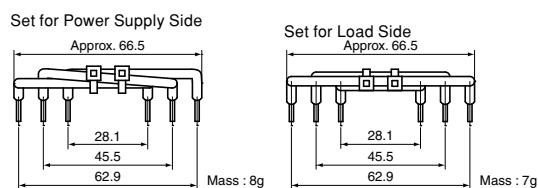

■ Mounting Procedures

- Interlock Unit

- (1) Connect two Magnetic Contactors with the two connection pieces ①.
- (2) Move the moveable projections ② on the Interlock Unit to the right side.
- (3) Insert the Interlock Unit directly from the top so that it is aligned with the projections ③ on the moveable portion on the Magnetic Contactors.
- (4) After you mount the Interlock Unit, slide the projection on the indicator window on the right side and then on the left side to confirm that they move smoothly.

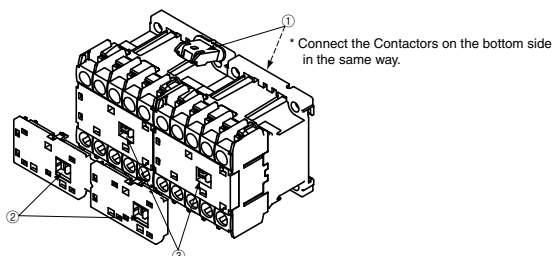

- Power Connection Kit for Reversing

Connect the Kit to the main circuit terminals. There are wires for the power supply side and wires for the load side. Be sure to connect them to the correct sides.

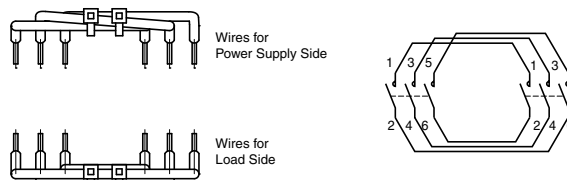

⚠ Caution Precaution for Correct Use

- When the Magnetic Contactors are switched rapidly, use an electrically interlock, such as a delay relay, to ensure a switching time of at least 15ms for the contacts of the two Magnetic Contactors.

Main Circuit Surge Suppression Unit and Separate Installation Unit

Main Circuit Surge Suppression Unit and Separate Installation Unit

■ Features

- Absorbs the surge voltage that is generated from three-phase motors when the Magnetic Contactor is switched to suppress the effects of surge voltage.
- Combination with a Separate Installation Unit enables both screw mounting and DIN rail mounting. (The SZ-ZM2 Main Circuit Surge Suppression Unit must be used with a Separate Installation Unit to secure it.)

■ Ratings and Types

Product name	Rated voltage and frequency	Applicable 3-phase motors	Type
Main Circuit Surge Suppression Unit	250V AC, 50/60Hz	200 to 240V AC, 0.1 to 2.2kW	SZ-ZM2
Separate Installation Unit	-	-	SZ-ZMH

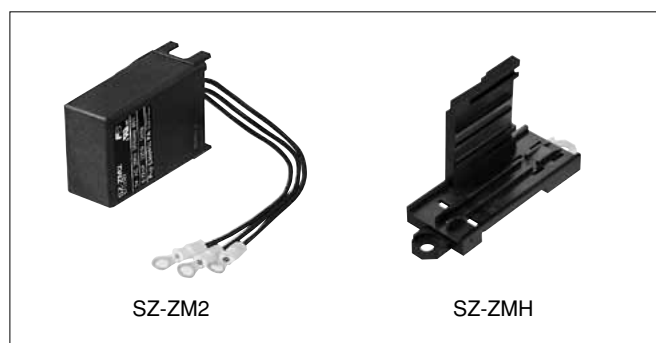

■ Performances

Item	Performance	
Dielectric strength	Between terminals	Rated voltage × 230% for 1 min
	Between terminals and Unit outer case	Rated voltage × 2 + 1,000V for 1 min
Insulation resistance	Between terminals	2,000MΩ min.
	Between terminals and Unit outer case	2,000MΩ min. per terminal
Electrostatic capacity tolerance (at 1kHz)	±10%	
Durability	1 million operations	

■ Mounting Procedures

- Combining the Main Circuit Surge Suppression Unit and Separate Installation Unit

Align projections ① on the Main Circuit Surge Suppression Unit with the mounting grooves ② on the inner surface of the Separate Installation Unit and press in firmly in the direction indicated by the arrow until the Units click into place.

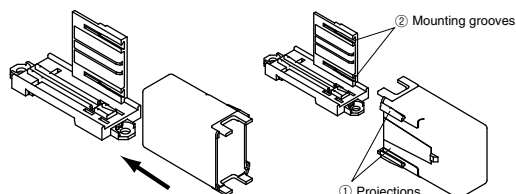

- Mounting to a Rail

- (1) Catch the black hook on the top of the Unit on the rail.
- (2) Press down on the Unit and press it against the rail, and latch the bottom hook on the rail.

* Always attach the Main Circuit Surge Suppression Unit with the Separate Installation Unit before mounting them to the rail.

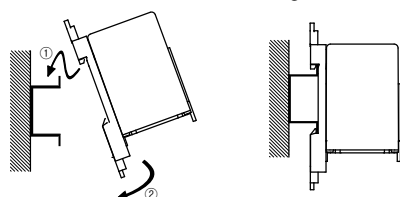

- Connection to the Magnetic Contactor

To connect the Main Circuit Surge Suppression Unit to the Magnetic Contactor, attach each of the terminals 2, 4, and 6 on the load side of the Magnetic Contactor to any of the leads on the Unit.

■ Main Circuit Surge Suppression Characteristics

(220V AC, 2.2kW motor)

- Without Main Circuit Surge Suppression Unit

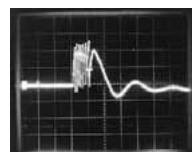

(No.CP-485)

- With Main Circuit Surge Suppression Unit

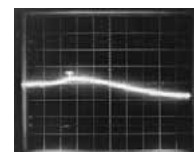

(No.CP-486)

■ Dimensions, mm

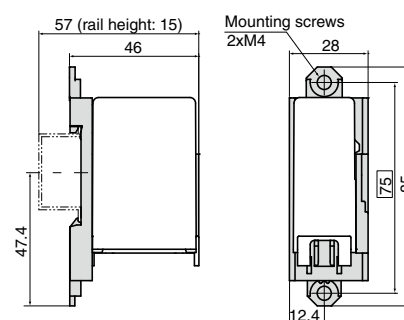

■ Circuit Connection Diagram

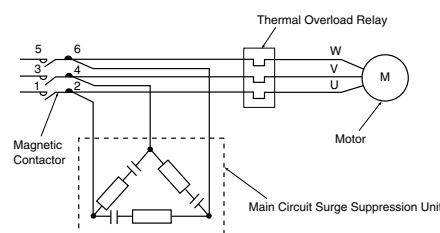

⚠ Caution Precaution for Correct Use

- Do not use the Main Circuit Surge Suppression Unit near inverter circuits or in other locations where a large harmonic component is present.

Mini-Contactors

SK Series

Coil Surge Suppression Units and Operation Indicator Lamps

Coil Surge Suppression Units and Operation Indicator Lamps

■ Features

- The Main Circuit Surge Absorber Unit absorbs the surge voltage that is generated when the coil in a Magnetic Contactor turns OFF. This suppresses malfunctioning of electronic circuits.
- The Operation Indicator Unit indicates with an LED when voltage is applied to the coil terminals.



■ Ratings and Types

Product name	Surge suppression element	Specification	Operation indicator lamp	Control circuit voltage		Type
				AC	DC	
Coil Surge Suppression Units	Varistor	Varistor voltage: 100V	-	24-48V	Not required.*	SZ1KZ1
		Varistor voltage: 240V		48-125V		SZ1KZ2
		Varistor voltage: 470V		100-250V		SZ1KZ3
		Varistor voltage: 100V	LED (red)	24-48V	Not required.*	SZ1KZ4
Varistor voltage: 240V	48-125V	SZ1KZ5				
Operation Indicator Units	-	-	LED (red)	12-24V	12-24V	SZ1KL1
				24-48V	24-48V	SZ1KL2
				48-125V	48-125V	SZ1KL3

Note: * A varistor is built into the SK□G and SK□L for DC operation.

■ Coil Surge Suppression Characteristics

Product	Application	Characteristics (200V AC coil)
Without Surge Suppression Unit	A sharp surge voltage is generated from the coil due to coil inductance as a result of the rapid change in voltage when the coil turns OFF. This becomes noise to surrounding electronic devices, and can cause malfunctions and circuit destruction.	 SK12A (0.1ms/div, 1kV/div)
Models with varistors built in	When the surge voltage reaches a certain level, current flows to the varistor that is connected in parallel with the coil. This serves to control the peak surge voltage. Varistors can be applied to either AC or DC. The suppressed surge voltage is approximately the varistor voltage.	 SK12A + SZ1KZ3 (2ms/div, 200V/div)

■ Mounting methods

- (1) Insert the Unit into the mounting holes in the Magnetic Contactor. The Unit must be oriented properly top to bottom. Do not mount the Unit backwards.

● Mounting to Non-reversing Magnetic Contactors

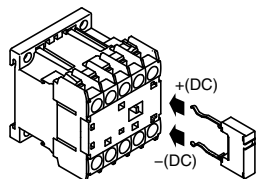

● Mounting to Reversing Magnetic Contactors

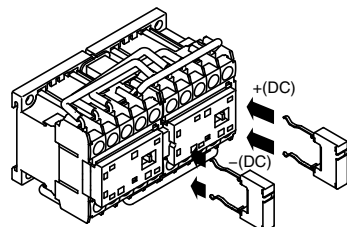

■ Dimensions, mm

● SZ1KZ1 to SZ1KZ3 (Coil Surge Suppression Units)

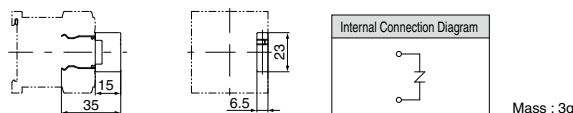

● SZ1KZ4 and SZ1KZ5 (Coil Surge Suppression Units with Operation Indicator Lamps)

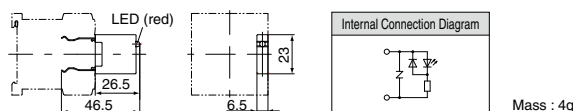

● SZ1KL1 to SZ1KL3 (Operation Indicator Units)

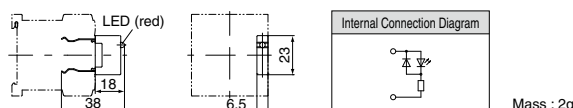

Thermal Overload Relay Reset Releases

■ Features

- A Reset Release is used to enable resetting a Thermal Relay from the front surface of the panel or from a remote location.



■ Ratings and Types

Product name	Release length [mm]	Mass [g]	Used with	Type
Thermal Overload Relay Reset Releases	300	30	2E Thermal Overload Relay	SZ-R1
	500	40	TK12 (Packaged together with Reset Releases for the TR-0N and 5-1N.)	SZ-R2
	700	50		SZ-R3

■ Mounting Procedure

● SZ-R1, R2, R3

- (1) Remove the front cover.

The cover can be easily removed as shown in the figure if you hold the cover near the hinges and pull strongly.

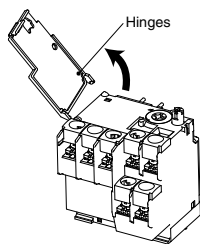

- (2) Insert the tab ① on the mounting base into the hole in the Thermal Relay and then latch the tabs ② and ③. To remove the mounting base, use a fine screwdriver to disengage tabs ② and ③.

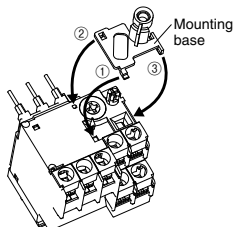

- (3) Tighten the male thread ④ on the Release in the female thread ⑤ on the mounting base. Remove the nut ⑥ from the Release, insert the Release through the panel from the back of the panel, and tighten the nut ⑥ from the front of the panel to secure the Release.

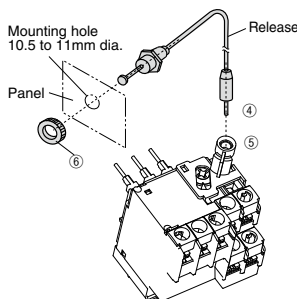

■ Dimensions, mm

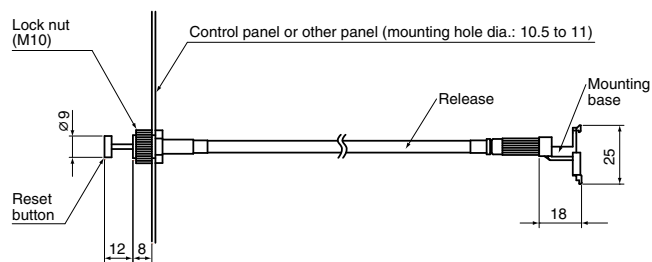

⚠ Caution Precaution for Correct Use

- When mounting the Release, do not allow the lead to bend within 25mm from the panel and within 35mm of the mounting base.
- Do not bend the lead of the Release to a radius of less than 15mm. (Refer to the figure on the right.)
- Prepare a mounting hole with a diameter of 10.5 to 11mm.

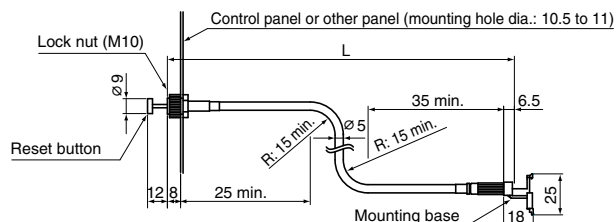

Mini-Contactors

SK Series

Link Module and Power Connection Kit for Reversing (Insert)

Link Module and Power Connection Kit for Reversing (Insert)

■ Features

- Connect a Manual Motor Starter and a Magnetic Contactor directly through a Link Module.
- A Reversing Connection Kit (Insert) for Combination Starters has joined the lineup.

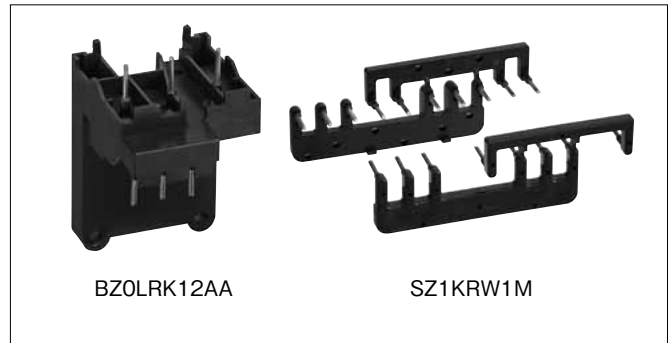

BZ0LRK12AA

SZ1KRW1M

■ Types

- Link Module: Electrically and mechanically connects a Manual Motor Starter and Magnetic Contactor.

 Photo No. KKD11-101	Applicable MMS	Applicable Magnetic Contactors	Type
	BM3RSB BM3RHB	SK06, SK09, and SK12	BZ0LRK12AA

- Power Connection Kit for Reversing (Insert): Used to reverse the circuit wiring between the main circuit terminals.

 Photo No. KKD11-113	Wire size	Number of conductors per set	Applicable MMS	Applicable types	Type
	1.6 dia.	<ul style="list-style-type: none"> • One set for power supply side • One set for load side 	BM3RSB BM3RHB	SK06, SK09, and SK12	SZ1KRW1M

■ Dimensions, mm

- Link Module

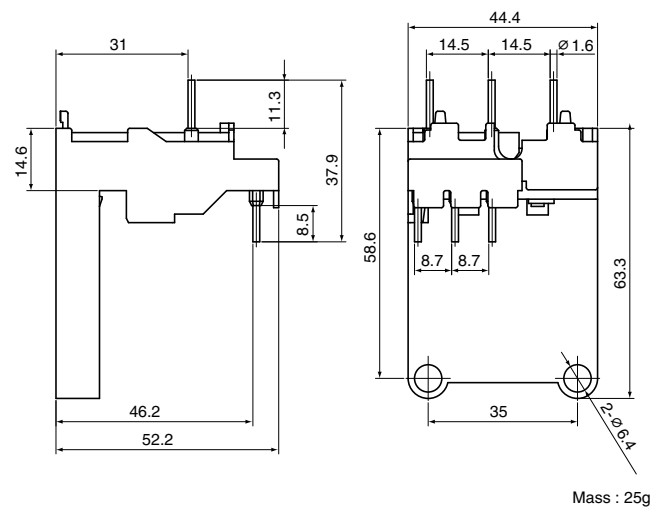

- Power Connection Kit for Reversing (Insert)

[Insert for Power Supply Side]

[Insert for Load Side]

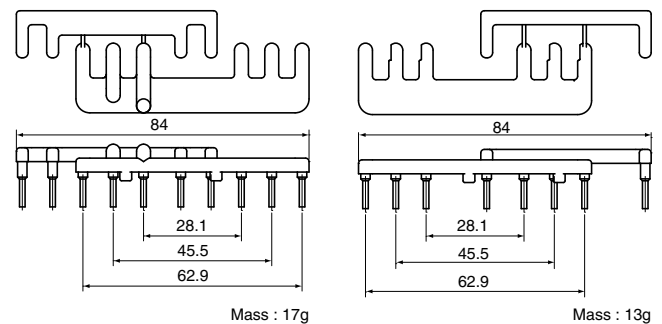

Mini-Contactors SK Series Link Module and Reversing Connection Unit (Insert)

■ Combination Starter Dimensions, mm

● BM3RS + SK□

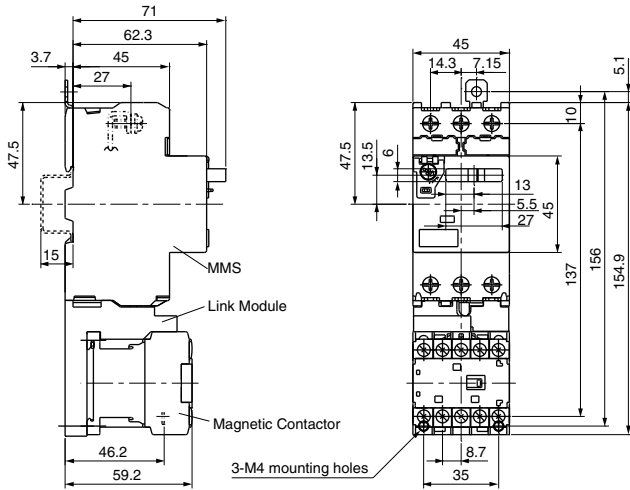

Rail mounting :
35mm rail (height: 15) x 1

MMS type	Magnetic Contactor type	Link Module type	Mass [g]
BM3RSB	SK06A, SK09A, SK12A	BZ0LRK12AA	520
BM3RSR	SK06G, SK09G, SK12G SK06L, SK09L, SK12L		550

● BM3RH + SK□

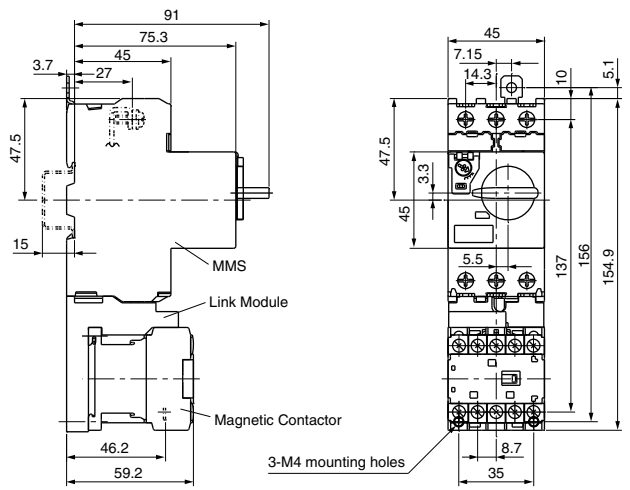

Rail mounting :
35mm rail (height: 15) x 1

MMS type	Magnetic Contactor type	Link Module type	Mass [g]
BM3RHB	SK06A, SK09A, SK12A	BZ0LRK12AA	540
BM3RHR	SK06G, SK09G, SK12G SK06L, SK09L, SK12L		570

■ Reversing Combination Starter Dimensions, mm

● BM3RS + SK□R

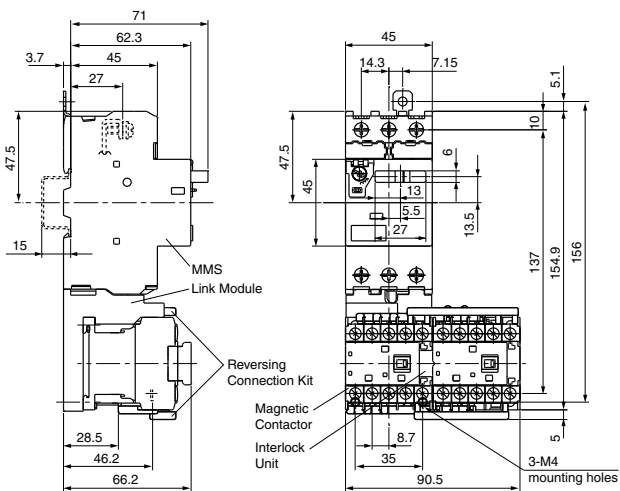

Rail Mounting :
35mm rail (height: 15) x 1

MMS type	Magnetic Starter type	Link Module type	Reversing Connection Kit	Interlock Unit	Mass [g]
BM3RSB	SK06A, SK09A, SK12A	BZ0LRK12AA	SZ1KARW1M	SZ1KRM	700
BM3RSR	SK06G, SK09G, SK12G SK06L, SK09L, SK12L				760

● BM3RH + SK□R

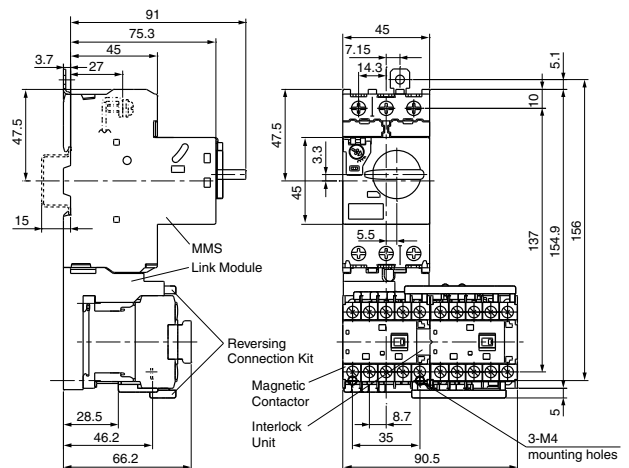

Rail mounting :
35mm rail (height: 15) x 1

MMS type	Magnetic Starter type	Link Module type	Reversing Connection Kit	Interlock Unit	Mass [g]
BM3RHB	SK06A, SK09A, SK12A	BZ0LRK12AA	SZ1KARW1M	SZ1KRM	720
BM3RHR	SK06G, SK09G, SK12G SK06L, SK09L, SK12L				780

Mini-Contactors

SK Series

Auxiliary Relays

Auxiliary Relays

■ Type Number Nomenclature

- Type Number Nomenclature
 - SK-Series Auxiliary Relays

SKH4 A H - 1 22

Basic type

SK-Series Auxiliary Relay

Operating method

- A : AC-operated models
- G : DC-operated models (2.4W)
- L : DC-operated models (1.2W)

Auxiliary contact

- Blank : Bifurcated contact
- H : Single button contact

Auxiliary contact arrangement

- 40 : 4NO
- 31 : 3NO+1NC
- 22 : 2NO+2NC

Coil voltage

AC operation					
		E	24V AC		
		F	48V AC		
		1	100V AC		
		H	110V AC		
		K	120V AC		
		2	200V AC		
		M	220V AC		
		P	240V AC		
		S	380V AC		
		4	400V AC		
		T	440V AC		
		5	500V AC		
DC operation					
2.4W		B	12V DC		
		E	24V DC		
		F	48V DC		
		G	60V DC		
		1	100V DC		
		H	110V DC		
		K	120V DC		
		2	200V DC		
		Y	210V DC		
		M	220V DC		
		1.2W		B	12V DC
				E	24V DC
F	48V DC				

■ Features

- International safety standards for standard models (IEC, GB, JIS, UL, and CSA).
- Models available with AC, DC, or low-power DC operating coils.
- Bifurcated contact for more reliable contact for micro-loads of 3mA at 5V DC.
- Models with high-capacity contacts (single button contact) are also available.
- Configure a wide range of contacts in combination with Auxiliary Contact Blocks.



SKH4A

■ Ordering Information (Types)

- Auxiliary Relays

SKH4 A H - E 22

① ② ③ ④ ⑤

① Series ② Operating coil ③ Contact specification ④ Coil voltage specification ⑤ Contact arrangement

■ Ratings

Refer to Auxiliary Contact Ratings on page 11.

■ Types

Operating coil specification ②	Contact specification ③	Coil voltage specification ④			Contact arrangement ⑤	Type
AC-operated models [A]	Bifurcated contact [blank]	24V [E]	120V [K]	380V [S]	4NO	SKH4A-□40
		48V [F]	200V [2]	400V [4]	3NO+1NC	SKH4A-□31
		100V [1]	220V [M]	440V [T]	2NO+2NC	SKH4A-□22
	Single button contact [H]	110V [H]	240V [P]	500V [5]	4NO	SKH4AH-□40
					3NO+1NC	SKH4AH-□31
					2NO+2NC	SKH4AH-□22
DC-operated models (2.4W) [G]	Bifurcated contact [blank]	12V [B]	100V [1]	210V [Y]	4NO	SKH4G-□40
		24V [E]	110V [H]	220V [M]	3NO+1NC	SKH4G-□31
		48V [F]	120V [K]		2NO+2NC	SKH4G-□22
	Single button contact [H]	60V [G]	200V [2]		4NO	SKH4GH-□40
					3NO+1NC	SKH4GH-□31
					2NO+2NC	SKH4GH-□22
DC-operated models (1.2W) [L]	Bifurcated contact [blank]	12V [B]			4NO	SKH4L-□40
		24V [E]			3NO+1NC	SKH4L-□31
		48V [F]			2NO+2NC	SKH4L-□22
	Single button contact [H]				4NO	SKH4LH-□40
					3NO+1NC	SKH4LH-□31
					2NO+2NC	SKH4LH-□22

Note. "□" in the type column is replaced with the coil voltage code.

Mini-Contactors SK Series Auxiliary Relays

■ Performances

● Durability (Based on IEC 60947-5-1)

Type	Number of contacts	Operating cycles per hour [times/hour]	Mechanical durability	Electrical durability					
				AC-15		AC-12		DC-13	DC-12
				220V	440V	220V	440V	220V	220V
SKH4	4	1800	10 million	500,000	500,000	250,000	250,000	250,000	500,000

■ Combinations with Auxiliary Contact Blocks

SK-Series Auxiliary Relays and Auxiliary Contacts Blocks can be combined as shown in the following table. Other combinations are not possible.

Auxiliary Contact Block	Type	SZ1KA40 SZ1KA40H	SZ1KA31 SZ1KA31H	SZ1KA22 SZ1KA22H	SZ1KA13 SZ1KA13H	SZ1KA04 SZ1KA04H	SZ1KA20 SZ1KA20H	SZ1KA11 SZ1KA11H	SZ1KA02 SZ1KA02H	SZ1FA11 SZ1FA11H
	Auxiliary relay type	Auxiliary contact arrangement								
SKH4A SKH4AH SKH4G SKH4GH	4NO	8NO	7NO+1NC	6NC+2NC	5NO+3NC	4NO+4NC	6NO	5NO+1NC	4NO+2NC	5NO+1NC
	3NO+1NC	7NO+1NC	6NO+2NC	5NO+3NC	4NO+4NC	3NO+5NC	5NO+1NC	4NO+2NC	3NO+3NC	4NO+2NC
	2NO+2NC	6NO+2NC	5NO+3NC	4NO+4NC	3NO+5NC	2NO+6NC	4NO+2NC	3NO+3NC	2NO+4NC	3NO+3NC
SKH4L SKH4LH	4NO	-	-	-	-	-	6NO	5NO+1NC	4NO+2NC	5NO+1NC
	3NO+1NC	-	-	-	-	-	5NO+1NC	4NO+2NC	3NO+3NC	4NO+2NC
	2NO+2NC	-	-	-	-	-	4NO+4NC	3NO+3NC	2NO+4NC	3NO+3NC

■ Linked Contact Compliance (Compliance with Requirements of IEC60947-5-1 Annex L)

Auxiliary Relay type	Auxiliary Contact Block	No Auxiliary Contact Block	SZ1KA□		SZ1FA11	SZ1KA□H		SZ1FA11H
			4-pole	2-pole		4-pole	2-pole	
SKH4A SKH4AH	○	○	×	×	×	×	×	×
SKH4G SKH4GH	○	○	×	×	○	○	○	○
SKH4L SKH4LH	○	○	-	○	○	-	○	○

○ : Complies.
× : Does not comply.

■ Dimensions, mm

SKH4

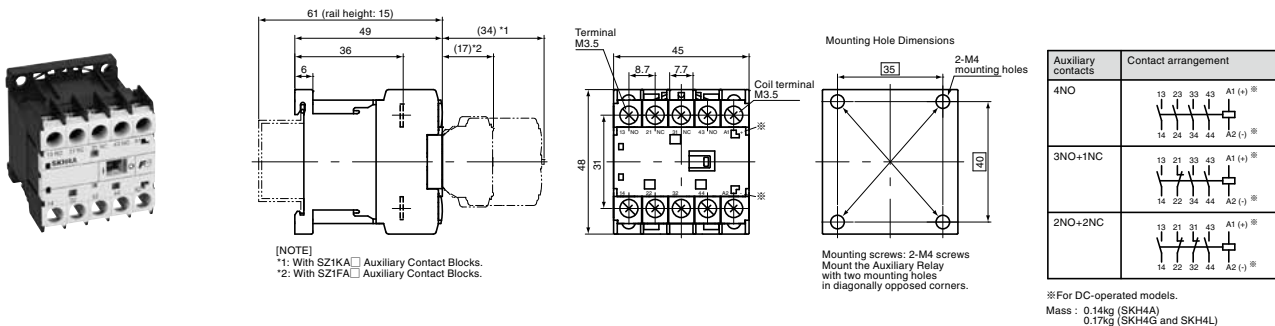

Safety Considerations

- Operate (keep) in the environment specified in the operating instructions and manual. High temperature, high humidity, condensation, dust, corrosive gases, oil, organic solvents, excessive vibration or shock might cause electric shock, fire, erratic operation or failure.
- For safe operation, before using the product read the instruction manual or user manual that comes with the product carefully or consult the Fuji sales representative from which you purchased the product.
- Products introduced in this catalog have not been designed or manufactured for such applications in a system or equipment that will affect human bodies or lives.
- Customers, who want to use the products introduced in this catalog for special systems or devices such as for atomic-energy control, aerospace use, medical use, passenger vehicle, and traffic control, are requested to consult with Fuji Electric FA.
- Customers are requested to prepare safety measures when they apply the products introduced in this catalog to such systems or facilities that will affect human lives or cause severe damage to property if the products become faulty.
- For safe operation, wiring should be conducted only by qualified engineers who have sufficient technical knowledge about electrical work or wiring.
- Follow the regulations of industrial wastes when the product is to be discarded.
- For further questions, please contact your Fuji sales representative or Fuji Electric FA.

 Fuji Electric FA Components & Systems Co., Ltd.

5-7, Nihonbashi Odemma-cho, Chuo-ku, Tokyo, 103-0011, Japan

URL <http://www.fujielectric.co.jp/fcs/eng>