



# Absolute encoders

## ENA58TL-S\*\*\*-IO-Link

- Absolut rotary encoder of the innovative Pure Line
- Solid shaft
- IO-Link Interface for process data, parameterization and diagnosis
- Suitable for condition monitoring
- Measuring range, direction of rotation and switching signals programmable
- Free of wear magnetic sampling
- High resolution and accuracy
- Status LEDs



### Function

Absolute encoders with IO Link are high precision encoders with internal magnetic sampling. The integrated IO Link interface offers an optimal adaption to different applications through parameterization as well as process data transfer and condition monitoring.

### Dimensions

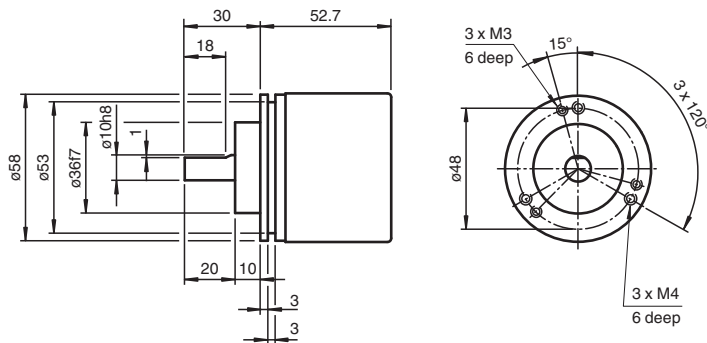

Clamping flange

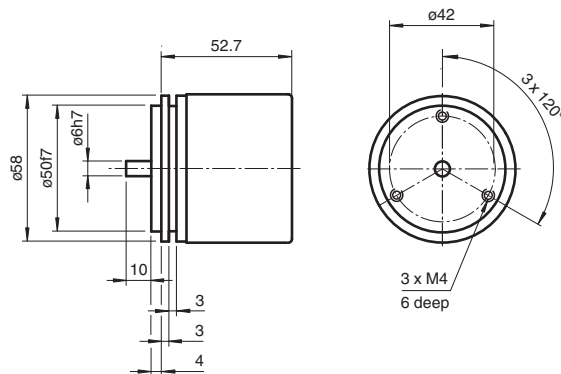

Servo flange

Release date: 2021-02-08 Date of issue: 2021-02-08 Filename: t193101\_eng.pdf

Refer to "General Notes Relating to Pepperl+Fuchs Product Information".

Pepperl+Fuchs Group  
www.pepperl-fuchs.com

USA: +1 330 486 0001  
fa-info@us.pepperl-fuchs.com

Germany: +49 621 776 1111  
fa-info@de.pepperl-fuchs.com

Singapore: +65 6779 9091  
fa-info@sg.pepperl-fuchs.com

**PF** PEPPERL+FUCHS

Connections

Dimensions in mm

Connector M12

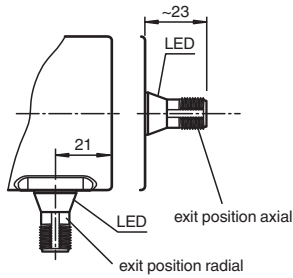

## Technical Data

General specifications	
Detection type	magnetic sampling
Device type	Absolut rotary encoder as Pure Line
Linearity error	$\leq \pm 0.1^\circ$
UL File Number	E223176 "For use in NFPA 79 Applications only", if UL marking is marked on the product.
Functional safety related parameters	
MTTF <sub>d</sub>	566 a at 40 °C
Mission Time (T <sub>M</sub> )	20 a
L <sub>10</sub>	420 E+8 revolutions at 40/110 N axial/radial shaft load
Diagnostic Coverage (DC)	0 %
Indicators/operating means	
LED STATUS	LED green flashing with short break (1 Hz) - IO-Link mode
Electrical specifications	
Operating voltage	U <sub>B</sub> 18 ... 30 V DC
No-load supply current	I <sub>0</sub> max. 50 mA
Power consumption	P <sub>0</sub> approx. 1.5 W
Time delay before availability	t <sub>v</sub> < 1 s
Interface	
Interface type	IO-Link
IO-Link Revision	1.1
Device profile	Identification & Diagnosis - I&D
Resolution	
Single turn	up to 16 Bit programmable
Multiturn	up to 15 Bit programmable
Overall resolution	up to 31 Bit programmable
Process data	
Vendor ID	1 (0x0001)
Device ID	5243907 (0x500403), 5243908 (0x500404), 5243911 (0x500407), 5243912 (0x500408)
Transfer rate	COM 3 (230.4 kBaud)
Min. cycle time	1.5 ms
SIO mode support	no
Compatible master port type	Class A Class B (use 3-pole adapter or 3-wire cable)

Release date: 2021-02-08 Date of issue: 2021-02-08 Filename: t193101\_eng.pdf

Refer to "General Notes Relating to Pepperl+Fuchs Product Information".

## Technical Data

<b>Connection</b>	
Connector	M12 connector, 5 pin , A-coded
<b>Standard conformity</b>	
Degree of protection	DIN EN 60529, IP65, IP67
Communication interface	IEC 61131-9 / IO-Link V1.1.2
Climatic testing	DIN EN 60068-2-78, no moisture condensation
Emitted interference	EN 61000-6-4:2007
Noise immunity	EN 61000-6-2:2005
Shock resistance	DIN EN 60068-2-27, 100 g, 6 ms
Vibration resistance	DIN EN 60068-2-6, 10 g, 10 ... 1000 Hz
<b>Approvals and certificates</b>	
UL approval	cULus Listed, General Purpose, Class 2 Power Source , if UL marking is marked on the product.
<b>Ambient conditions</b>	
Operating temperature	-40 ... 85 °C (-40 ... 185 °F)
Storage temperature	-40 ... 85 °C (-40 ... 185 °F)
Relative humidity	98 % , no moisture condensation
<b>Mechanical specifications</b>	
Material	
Housing	Zinc plated steel, painted
Flange	Aluminum
Shaft	Stainless steel
Mass	approx. 350 g
Rotational speed	max. 12000 min <sup>-1</sup>
Moment of inertia	< 30 gcm <sup>2</sup>
Starting torque	< 3 Ncm
Shaft load	
Axial	40 N
Radial	110 N

## Connection

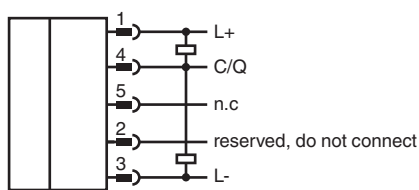



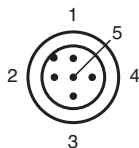









## Connection Assignment



Release date: 2021-02-08 Date of issue: 2021-02-08 Filename: t193101\_eng.pdf

## Accessories

	<b>ICE1-8IOL-G60L-V1D</b>	Ethernet IO-Link module with 8 inputs/outputs
	<b>IO-Link-Master02-USB</b>	IO-Link master, supply via USB port or separate power supply, LED indicators, M12 plug for sensor connection
	<b>V1-G-0,6M-PUR-V1-G</b>	Cordset M12 socket straight to M12 plug straight A-coded, 4-pin, PUR cable grey
	<b>V15-G-1M-PUR-V15-G</b>	Cordset M12 socket straight to M12 plug straight A-coded, 5-pin, PUR cable grey
	<b>9401 6*10</b>	Spring steel coupling
	<b>9401 6*6</b>	Spring steel coupling
	<b>9402 6*6</b>	Spring steel coupling
	<b>9404 6*6</b>	Spring disk coupling
	<b>9409 6*10</b>	Bellows coupling
	<b>9409 6*6</b>	Bellows coupling
	<b>9409 6*8</b>	Bellows coupling
	<b>9410 6*6</b>	Precision coupling
	<b>9460 6*6</b>	Stainless steel bellows coupling
	<b>KW-6/10</b>	Helical coupling
	<b>KW-6/6</b>	Helical coupling
	<b>KW-6/8</b>	Helical coupling
	<b>9108, 6</b>	Measuring wheel
	<b>9109, 6</b>	Measuring wheel for shaft diameter 6 mm
	<b>9110, 6</b>	Measuring wheel for shaft diameter 6 mm
	<b>9113, 6</b>	Measuring wheel for shaft diameter 6 mm









Release date: 2021-02-08 Date of issue: 2021-02-08 Filename: t193101\_eng.pdf

Refer to "General Notes Relating to Pepperl+Fuchs Product Information".

Pepperl+Fuchs Group  
www.pepperl-fuchs.comUSA: +1 330 486 0001  
fa-info@us.pepperl-fuchs.comGermany: +49 621 776 1111  
fa-info@de.pepperl-fuchs.comSingapore: +65 6779 9091  
fa-info@sg.pepperl-fuchs.com

**PEPPERL+FUCHS**

## Accessories

	<b>MBT-36ALS</b>	Spring-loaded mounting bracket with a diameter of 36 mm
	<b>MBT-36ALS120</b>	Spring arm for larger spring deflections for diameter 58 rotary encoder with clamping flange
	<b>ICE1-8IOL-G30L-V1D</b>	Ethernet IO-Link module with 8 inputs/outputs
	<b>ICE2-8IOL-G65L-V1D</b>	EtherNet/IP IO-Link master with 8 inputs/outputs
	<b>ICE2-8IOL-K45P-RJ45</b>	EtherNet/IP IO-Link master with 8 inputs/outputs, DIN rail, push-in connectors
	<b>ICE2-8IOL-K45S-RJ45</b>	EtherNet/IP IO-Link master with 8 inputs/outputs, DIN rail, screw terminal
	<b>ICE3-8IOL-G65L-V1D</b>	PROFINET IO IO-Link master with 8 inputs/outputs
	<b>ICE3-8IOL-K45P-RJ45</b>	PROFINET IO IO-Link master with 8 inputs/outputs, DIN rail, push-in terminals
	<b>ICE3-8IOL-K45S-RJ45</b>	PROFINET IO IO-Link master with 8 inputs/outputs, DIN rail, screw terminal

**Type Code**

**E N A 5 8 T L - S - - - - - 1 6 - I O - - - - 0 1**

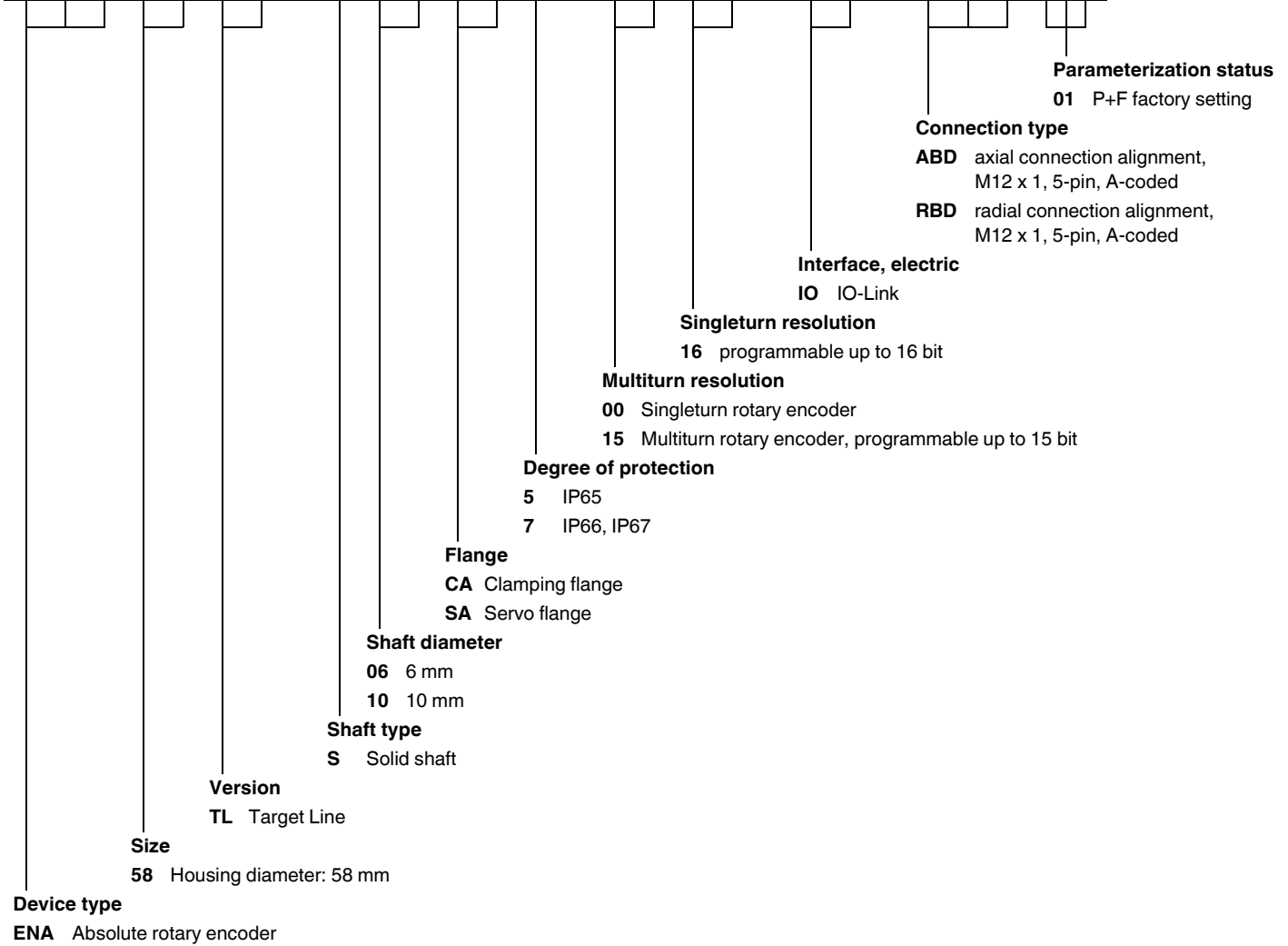

Release date: 2021-02-08 Date of issue: 2021-02-08 Filename: t193101\_eng.pdf

Refer to "General Notes Relating to Pepperl+Fuchs Product Information".