



HEIDENHAIN



iTNC 530 HSCI

The Versatile Contouring Control for Milling, Drilling, Boring Machines and Machining Centers

Information for the Machine Tool Builder

TNC contouring control with drive system from HEIDENHAIN

General information

iTNC 530

- Contouring control for **milling, drilling, boring machines and machining centers**
- Up to 18 axes and closed-loop main spindle
- HEIDENHAIN inverter systems and motors recommended
- Uniformly digital with HSCI interface and EnDat interface
- TFT color flat-panel display, 19-inch or 15-inch
- Storage medium: HDR hard disk with 160 GB / SSDR solid state disk with 32 GB
- Programming in HEIDENHAIN conversational format, with smarT.NC or according to DIN/ISO
- Standard milling, drilling and boring cycles
- Touch probe cycles
- FK free contour programming
- Special functions for fast 3-D machining
- Short block processing time (0.5 ms)
- Automatic calculation of cutting data
- Pallet management

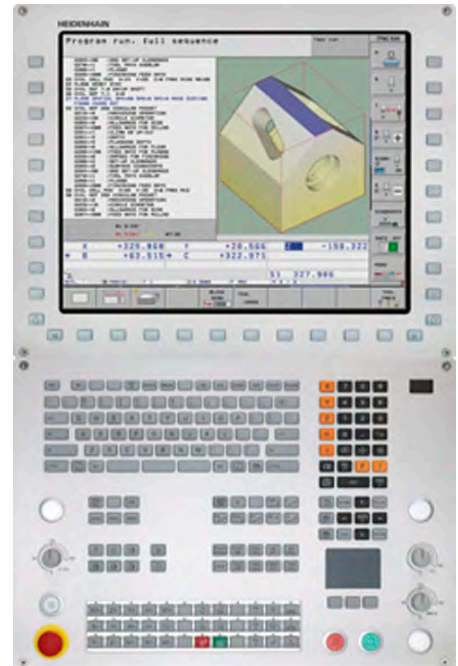

System test

Controls, motors and encoders from HEIDENHAIN are in most cases integrated as components in larger systems. In these cases, comprehensive tests of the complete system are required, irrespective of the specifications of the individual devices.

Expendable parts

In particular the following parts in controls from HEIDENHAIN are subject to wear:

- Hard disk
- Buffer battery
- Fan

Standards

Standards (ISO, EN, etc.) apply only where explicitly stated in the catalog.

Note

Microsoft, Windows, Windows Vista and Internet Explorer are registered trademarks of Microsoft Corporation.

Intel, Intel Core and Celeron are registered trademarks of Intel Corporation.

Validity

The features and specifications described here apply for the following control and NC software versions:

iTNC 530 HSCI with NC software versions

606420-04 (export license required)

606421-04 (no export license required)

This catalog supersedes all previous editions, which thereby become invalid. **Subject to change without notice.**

Requirements

Some of these specifications require particular machine configurations. Please note also that, for some functions, a special PLC program must be created by the manufacturer.

Functional safety

If no explicit distinction is made between standard and FS components (FS = functional safety), then the data and other information apply to both versions (e.g. TE 745, TE 745 FS).

Contents

TNC contouring control with drive system from HEIDENHAIN	2
Overview tables	4
HSCI control components	15
Accessories	32
Cable overview	44
Technical description	51
Data transfer and communication	78
Mounting information	81
Overall dimensions	83
General information	107
Other HEIDENHAIN controls	109
Subject index	110

Please refer to the **page references** in the **tables** with the specifications.

Overview tables

Components

Control systems		15" design	19" design	Page
Main computer	<i>For operating panel</i>	MC 7422, MC 7522 (screen integrated) or MC 6542	MC 6542	15
	<i>For electrical cabinet</i>	MC 6441, MC 6541, MC 6542 or MC 6641	MC 6441, MC 6541, MC 6542 or MC 6641	
Memory medium	<i>MC 7x22; MC 6x42</i>	SSDR solid state disk		17
	<i>MC 6x41</i>	HDR hard disk		
NC software license		On SIK component		17
Screen		BF 750 (integrated in MC 7x22)	BF 760	27
Operating panel		TE 720 or TE 730 or TE 735	TE 740 or TE 745	27
Machine operating panel		MB 720 (integrated in TE 735)	Integrated in TE 745	27
		PLB 6001 (HSCI adapter for OEM machine operating panel)		33
Controller unit	6 control loops	CC 6106		22
	8 control loops	CC 6108		22
	10 control loops	CC 6110		22
	12 control loops	CC 6106 + CC 6106		22
	14 control loops	CC 6108 + CC 6106		22
	16 control loops	CC 6108 + CC 6108		22
	18 control loops	CC 6106 + CC 6106 + CC 6106 or CC 6110 + CC 6108		22
	20 control loops	CC 6110 + CC 6110		22
Power supply¹⁾		PSL 130 / PSL 135		32
PLC inputs/ outputs¹⁾	With HSCI interface	PL 6000 consisting of PLB 62xx basic module (system PL) or PLB 61xx (expansion PL) and I/O modules		29
		On UEC		24
		On UMC		26
	With PROFIBUS-DP interface	PL 550 consisting of PLB 550 basic module and I/O modules		31
Additional modules¹⁾		CMA-H for analog axes/spindles in the HSCI system		34
		Module for PROFIBUS-DP		
Inverter systems		Compact inverters and modular inverters		*)
Inverters with integrated controller unit	4 control loops	UEC 111		24
		UMC 111		26
	5 control loops	UEC 112		24
	6 control loops	UEC 113		
Connecting cables				44

*) For further information, refer to the *Inverter Systems for HEIDENHAIN controls* brochure

1) May be necessary depending on the configuration

Please note: The MC main computer does not have any PLC inputs/outputs. Therefore one PL 6000, UEC or UMC is necessary for each control. They feature safety-relevant inputs/outputs as well as the connections for touch probes.

Accessories

Accessories	iTNC 530	Page
Electronic handwheels	<ul style="list-style-type: none"> • HR 410 portable handwheel or • HR 520 portable handwheel with display or • HR 550 FS portable wireless handwheel with display or • HR 130 panel-mounted handwheel or • Up to three HR 150 panel-mounted handwheels via HRA 110 handwheel adapter 	37
Workpiece touch probes	<ul style="list-style-type: none"> • TS 260¹⁾ touch trigger probe with cable connection or • TS 460¹⁾ touch trigger probe with radio or infrared transmission or • TS 444 touch trigger probe with infrared transmission or • TS 642 touch trigger probe with infrared transmission or • TS 740 touch trigger probe with infrared transmission 	35
Tool touch probes	<ul style="list-style-type: none"> • TT 160¹⁾ touch trigger probe with cable connection or • TT 460¹⁾ touch trigger probe with radio or infrared transmission or • TL Nano laser system for contact-free tool measurement or • TL Micro laser system for contact-free tool measurement 	36
USB hub	✓	79
Programming station	Control software for PCs for programming, archiving, and training <ul style="list-style-type: none"> • Single-station license with original control keyboard • Single-station license with virtual keyboard • Network license with virtual keyboard • Demo version with virtual keyboard or PC keyboard—free of charge 	2)
Industrial PC	ITC 755 – additional operating station with touch screen and ASCII keyboard ITC 750/ITC 760 – additional operating station; separate TE 7xx necessary IPC 6641 – industrial PC for Windows	40
Snap-on keys	For the control For the handwheel	42 41

¹⁾ New generation of touch probes

²⁾ For more information, refer to the *Programming Station TNC* brochure.

Accessories / Software	iTNC 530	Page
PLCdesign ¹⁾	PLC development software	75
KinematicsDesign ¹⁾	Software for creating kinematics and initializing DCM	65
TNCremo ²⁾	Data transfer software	79
TNCremoPlus ²⁾	Data transfer software with “live” screen	79
CycleDesign ¹⁾	Software for creating cycle structures	77
TNCkeygen ¹⁾	Software for enabling SIK options for a limited time, and for day-by-day access to the OEM area	17
TNCscope ¹⁾	Software for data recording	72
DriveDiag ¹⁾	Software for diagnosis of digital control loops	71
TNCopt ¹⁾	Software for putting digital control loops into service	71
IOconfig ¹⁾	Software for configuring PLC I/O and PROFIBUS-DP components	30
TeleService ¹⁾	Software for remote diagnostics, monitoring, and operation	72
RemoTools SDK ¹⁾	Function library for developing customized applications for communication with HEIDENHAIN controls	80
virtualTNC ¹⁾	Control component for virtual machines	80
TNCtest ¹⁾	Software for creation and execution of acceptance tests	-

¹⁾ Available to registered customers for downloading from the Internet

²⁾ Available to all customers (without registration) for downloading from the Internet

Specifications

Specifications	iTNC 530	Page
Axes¹⁾	Max. 18	55
Rotary axes	Max. 3	
Synchronized axes	✓	
PLC axes	✓	
Main spindle	Max. 2; second spindle can be controlled alternately with the first	58
Speed ²⁾	Max. 60 000 min ⁻¹	58
Operating mode switchover	✓	58
Position-controlled spindle	✓	58
Spindle orientation	✓	58
Gear shifting	✓	58
Milling-head change	Programmable via PLC	58
NC program memory	MC 6x41: ≈ 144 GB on HDR hard disk MC 6542, MC 7x22: ≈ 21 GB on SSDR solid state disk	15
Input resolution and display step		55
Linear axes	0.1 μm	
Rotary axes	0.0001°	
Functional safety	With FS components, SPLC and SKERN	52
For applications up to	<ul style="list-style-type: none"> • SIL 2 according to EN 61 508 • Category 3, PL d according to EN ISO 13 849-1: 2008 	
Interpolation	MC	
Straight line	In 5 axes	*
Circular	In 3 axes	*
Helical	✓	*
Spline	✓	62
Axis feedback control		60
With following error	✓	
With feedforward	✓	
Axis clamping	✓	55
Maximum feed rate	$\frac{60000 \text{ min}^{-1}}{\text{No. of motor pole pairs}} \cdot \text{Screw pitch [mm]}$ at $f_{\text{PWM}} = 5000 \text{ Hz}$	55

Specifications	iTNC 530		Page
Cycle times of main computer	MC		61
Block processing	0.5 ms		62
Cycle times of controller unit	CC/UEC/UMC		61
Path interpolation	3 ms		61
Fine interpolation	Single speed: 0.2 ms Double speed: 0.1 ms (option 49)		
Position controller	Single speed: 0.2 ms Double speed: 0.1 ms (option 49)		
Speed controller	Single speed: 0.2 ms Double speed: 0.1 ms (option 49)		
Current controller	f_{PWM} 3333 Hz 4000 Hz 5000 Hz 6666 Hz 8 000 Hz 10 000 Hz	T_{INT} 150 μs 125 μs 100 μs 75 μs with option 49 60 μs with option 49 50 μs with option 49	
Permissible temperature range	Operation: In electrical cabinet: 5 °C to 40 °C In operating panel: 0 °C to 50 °C Storage: -20 °C to 60 °C		

- *) For further information, refer to the iTNC 530 brochure (ID 892921-xx)
- 1) As ordered
- 2) On motors with two pole pairs

Machine interfacing

Machine interfacing	iTNC 530	Page
Feature content level (FCL)	✓	17
Error compensation	✓	66
Linear axis error	✓	66
Nonlinear axis error	✓	66
Backlash	✓	66
Reversal spikes with circular movement	✓	66
Hysteresis	✓	66
Thermal expansion	✓	66
Static friction	✓	66
Sliding friction	✓	66
Integrated PLC	✓	73
Program format	Statement list	73
Program input at the control	✓	73
Program input by PC	✓	73
PLC memory	> 1 GB	73
PLC cycle time	9 ms to 30 ms (adjustable)	73
PLC inputs/outputs¹⁾	A PLC system can consist of max. seven PLB 61xx and max. 2 MB 7xx, one TE 7x5 or one PLB 6001. A total maximum of 1000 inputs/outputs is supported.	29, 24
PLC inputs, 24 V DC ¹⁾	Via PL, UEC, UMC	29
PLC outputs, 24 V DC ¹⁾	Via PL, UEC, UMC	29
Analog inputs, ± 10 V	Via PL	29
Inputs for PT 100 thermistors	Via PL	29
Analog outputs, ± 10 V	Via PL	29
PLC functions	✓	73
Small PLC window	✓	74
Large PLC window	✓	74
PLC soft keys	✓	74
PLC positioning	✓	74
PLC basic program	✓	76
Integration of applications		75
High-level language programming	Python programming language used in combination with the PLC (option 46)	75
User interfaces can be custom-designed	Inclusion of specific user interfaces from the machine tool builder (option 46)	75

¹⁾ Further PLC inputs/outputs via PL 550 for connection to MC with PROFIBUS-DP additional module

Machine interfacing	iTNC 530	Page
Commissioning and diagnostic aids		71
DriveDiag	Software for diagnosis of digital drive systems	71
TNCOpt	Software for putting digital control loops into service	71
KinematicsDesign	Software for creating the machine kinematics, initialization of DCM	65
Integrated oscilloscope	✓	72
Trace function	✓	72
Logic diagram	✓	72
Table function	✓	72
Log	✓	72
Bus diagnostics	✓	72
Data interfaces	✓	
Ethernet	2 x 1000BASE-T	78
USB	Rear: 3 x USB 3.0 Front: USB 2.0	78
RS-232-C	✓	78
Protocols		78
Standard data transfer	✓	78
Blockwise data transfer	✓	78
Blockwise data transfer and simultaneous program run	With programming memory on the hard disk	
LSV2	✓	78

¹⁾ Further PLC inputs/outputs via PL 550 for connection to MC with PROFIBUS-DP additional module

Encoder inputs		CC 6106	CC 6108	CC 6110	UEC 111	UMC 111	UEC 112	UEC 113	59
Position		6	8	10	4	-	5	6	59
	Incremental	1 V _{PP}							59
	absolute	EnDat 2.2							59
Speed		6	8	10	4	4	5	6	59
	Incremental	1 V _{PP}							59
	absolute	EnDat 2.2							59
Nominal-value outputs		CC 6106	CC 6108	CC 6110	UEC 111	UMC 111	UEC 112	UEC 113	59
PWM		6	8	10	-	-	-	-	21
Motor connections		-	-	-	4	4	5	6	21

User functions

User function	iTNC 530	
	Standard	Option
Short description	✓ 0-7 77 78 ✓	Basic version: 3 axes plus spindle A total of 14 additional NC axes or 13 additional NC axes plus second spindle Digital current and shaft speed control
Program entry	✓ ✓ ✓ 42	HEIDENHAIN conversational With smarT.NC According to ISO Direct loading of contours or machining positions from DXF files and saving as smarT.NC or conversational contouring programs, or as point tables
Program optimization	✓	Point filter for smoothing externally created NC programs
Position entry	✓ ✓ ✓ ✓	Nominal positions for lines and arcs in Cartesian coordinates or polar coordinates Incremental or absolute dimensions Display and entry in mm or inches Display of the handwheel path during machining with handwheel superimpositioning
Tool compensation	✓ ✓ 9	Tool radius in the working plane and tool length Radius-compensated contour look-ahead for up to 99 blocks (M120) Three-dimensional tool-radius compensation for changing tool data without having to recalculate an existing program
Tool tables	✓	Multiple tool tables with any number of tools
Cutting data	✓ ✓ ✓	Cutting data tables for automatic calculation of spindle speeds and feed rates from tool-specific data (cutting speed, feed per tooth) Entry of cutting speed as alternative to the spindle shaft speed Feed rate can also be entered as F_z (feed per tooth) or F_u (feed per revolution)
Constant contour speed	✓ ✓	With respect to the path of the tool center With respect to the cutting edge
Parallel operation	✓	Creating a program with graphical support while another program is being run
3-D machining	✓ 9 9 9 9 9 92 9	Motion control with smoothed jerk 3-D tool compensation through surface normal vectors Tool Center Point Management (TCPM): Using the electronic handwheel to change the angle of the swivel head during program run without affecting the position of the tool point Keeping the tool normal to the contour Tool radius compensation normal to the tool direction Manual traverse in the active tool-axis system Compensating form errors of tools with 3D-ToolComp Spline interpolation
Rotary table machining	8 8	Programming of cylindrical contours as if in two axes Feed rate in mm/min
Contour elements	✓ ✓ ✓ ✓ ✓ ✓ ✓	Straight line Chamfer Circular path Circle center Circle radius Tangentially connecting circular arc Corner rounding
Approaching and departing the contour	✓ ✓	Via straight line: tangential or perpendicular Via circular arc

User function	Standard	Option	iTNC 530
Adaptive Feed Control		45	AFC: Adaptive feed control adjusts the contouring feed rate to the current spindle power
Collision monitoring		40 40 40 40 40	Dynamic Collision Monitoring (DCM) Graphic depiction of the active collision objects (FCL 04) Fixture monitoring Tool holder monitoring DCM in the Test Run mode
FK free contour programming	✓		FK free contour programming in HEIDENHAIN conversational format with graphic support for workpiece drawings not dimensioned for NC
Program jumps	✓ ✓ ✓		Subprograms Program-section repeat Any desired program as subprogram
Fixed cycles	✓ ✓ ✓ ✓ ✓ ✓ ✓ ✓ ✓ ✓ ✓ ✓ ✓	96	Drilling, tapping with a floating tap holder, rigid tapping Peck drilling, reaming, boring, counterboring, centering Milling inside and outside threads Clearing level and oblique surfaces Multioperation machining of straight and circular slots Multi-operation machining of rectangular and circular pockets, rectangular and circular studs Cartesian and polar point patterns Contour train (also 3-D), contour pocket—also with contour-parallel machining Contour slot with trochoidal milling Interpolation turning (only with functional safety (FS)) OEM cycles (special cycles developed by the machine tool builder) can be integrated Engraving cycle: Engrave text or numbers in a straight line or on an arc
Coordinate transformation	✓	8 44	Datum shift, rotation, mirror image, scaling factor (axis-specific) Tilting the working plane, PLANE function <i>Manually definable</i> : Global program settings make it possible to manually define shifts, rotations, and handwheel superimpositioning
Q parameters Programming with variables	✓ ✓ ✓ ✓ ✓ ✓		Mathematical functions =, +, −, *, /, sin α, cos α, tan α, arc sin, arc cos, arc tan, a ⁿ , e ⁿ , ln, log, square root of a, square root of (a ² + b ²) Logical operations (=, = /, <, >) Parentheses Absolute value of a number, constant π, negation, truncation of digits before or after decimal point Functions for calculation of circles Functions for text processing
Programming aids	✓ ✓ ✓ ✓ ✓ ✓		Calculator Complete list of all current error messages Context-sensitive help function for error messages TNCguide: The integrated help system. User information available directly on the iTNC 530; context-sensitive (FCL 03) Graphic support for the programming of cycles Comment and structure blocks in the NC program
Teach-in	✓		Actual positions can be transferred directly into the NC program
Test graphics Display modes	✓ ✓ ✓		Graphic simulation before a program run, even while another program is running Plan view / projection in 3 planes / 3-D view, also in tilted working plane Magnification of details
3-D line graphics	✓		For verification of programs created offline (FCL 02)
Programming graphics	✓		In the Programming and Editing mode, the contour of the NC blocks is drawn on screen while they are being entered (2-D pencil-trace graphics), even while another program is running

User function			iTNC 530
	Standard	Option	
Program-run graphics Display modes	✓ ✓		Graphic simulation during real-time machining Plan view / projection in 3 planes / 3-D view
Machining time	✓ ✓		Calculating the machining time in the Test Run mode of operation Display of the current machining time in the Program Run operating modes
Returning to the contour	✓ ✓		Mid-program startup in any block in the program, returning the tool to the calculated nominal position to continue machining; the graphic support in smarT.NC also lets you return to a point pattern Program interruption, contour departure and return
Reference-point management	✓		One table per traverse range for storing reference points
Datum tables	✓		Multiple datum tables, for storing workpiece-related datums
Pallet tables	✓		Workpiece-oriented or tool-oriented execution of pallet tables with any number of entries for selection of pallets, part programs and datums
Touch probe cycles	✓ ✓ ✓ ✓ ✓ ✓	48	Touch probe calibration Compensation of workpiece misalignment, manual or automatic Setting of reference points, manual or automatic Automatic tool and workpiece measurement Global setting of touch-probe parameters (FCL 02) Probing cycle for three-dimensional measurements. Toggle between showing the measurement results in the coordinate system of the workpiece or the machine (FCL 03) Automatic measurement and optimization of machine kinematics
Conversational languages	✓		English, German, Czech, French, Italian, Spanish, Portuguese, Dutch, Swedish, Danish, Finnish, Norwegian, Slovenian, Slovak, Polish, Hungarian, Russian (Cyrillic), Romanian, Turkish, Chinese (traditional and simplified), Korean

Options

Option number	Option	As of NC software 60642x-	ID	Remark	Page
0	Additional Axis 1	01	ID 354540-01	Additional control loop 1	20
1	Additional Axis 2	01	ID 353904-01	Additional control loop 2	20
2	Additional Axis 3	01	ID 353905-01	Additional control loop 3	20
3	Additional Axis 4	01	ID 367867-01	Additional control loop 4	20
4	Additional Axis 5	01	ID 367868-01	Additional control loop 5	20
5	Additional Axis 6	01	ID 370291-01	Additional control loop 6	20
6	Additional Axis 7	01	ID 370292-01	Additional control loop 7	20
7	Additional Axis 8	01	ID 370293-01	Additional control loop 8	20
8	Software option 1	01	ID 367591-01	Rotary table machining	55
				<ul style="list-style-type: none"> • Programming of cylindrical contours as if in two axes • Feed rate in mm/min 	
				Coordinate transformation	56
				<ul style="list-style-type: none"> • Tilting the working plane, PLANE function 	
				Interpolation	
				<ul style="list-style-type: none"> • Circle in 3 axes with tilted working plane 	
9	Software option 2	01	ID 367590-01	3-D machining	56
				<ul style="list-style-type: none"> • 3-D tool compensation through surface normal vectors • Tool center point management (TCPM): Using the electronic handwheel to change the angle of the swivel head during program run without affecting the position of the tool point • Keeping the tool normal to the contour • Tool radius compensation normal to the tool direction • Manual traverse in the active tool-axis system 	
				Interpolation	
				<ul style="list-style-type: none"> • Linear in 5 axes (export license required) • Spline: execution of splines (3rd degree polynomial) 	
18	HEIDENHAIN DNC	01	ID 526451-01	Communication with external PC applications over COM component	80
40	DCM collision	01	ID 526452-01	Dynamic Collision Monitoring (DCM)	64
42	DXF converter	01	ID 526450-01	Load and convert DXF contours	
44	Global PGM Settings	01	ID 576057-01	Global program settings	
45	Adaptive feed control (AFC)	01	ID 579648-01	Adaptive Feed Control	63
46	Python OEM process	01	ID 579650-01	Execute Python applications	75
48	KinematicsOpt	01	ID 630916-01	Touch probe cycles for automatic measurement of rotary axes	66
49	Double-speed axes	01	ID 632223-01	Short control-loop cycle times for direct drives	61
52	KinematicsComp	01	ID 661879-01	Spatial compensation of error in rotary and linear axes	67
77	4 additional axes	01	ID 634613-01	4 additional control loops	20
78	8 additional axes	01	ID 634614-01	8 additional control loops	20

Option number	Option	As of NC software 60642x-	ID	Remark	Page
92	3D-ToolComp	01	ID 679678-01	Compensating tool form error (only with software option 2)	
93	Extended Tool Management	01	ID 676938-01	Extended tool management	
96	Adv. Spindle Interp.	02	ID 751653-01	Enhanced functions for an interpolated spindle (not with functional safety (FS))	
98	CAD viewer	02	ID 800553-01	Open CAD files directly on the TNC	
101 - 130	OEM option	01	ID 579651-01 to ID 579651-30	Options of the machine tool builder	
133	Remote Desk. Manager	02	ID 894423-01	Display and operation of external computer units (e. g. a Windows PC)	79
141	Cross Talk Comp.	02	ID 800542-01	CTC: Compensation of axis couplings	68
142	Pos. Adapt. Control	02	ID 800544-01	PAC: Position-dependent adaptation of control parameters	69
143	Load Adapt. Control	02	ID 800545-01	LAC: Load-dependent adaptation of control parameters	69
144	Motion adaptive control	03	ID 800546-01	MAC: Motion-dependent adaptation of control parameters	70
145	Active Chatter Control	03	ID 800547-01	ACC: Active suppression of chatter	63
146	Active Vibration Damping	04	ID 800548-01	AVD: Active vibration damping	69

HSCI control components

Main computer

Main computer	<p>The MC main computers feature:</p> <ul style="list-style-type: none">• Processor• RAM memory• HSCI interface to the CC 6xxx or UEC controller unit and to other control components• HDL interface to the BF 7xx visual display unit (BF integrated in MC 7x22)• USB 3.0 interface to the TE 7x5 operating panel <p>To be ordered separately, and installed in the main computer by the OEM:</p> <ul style="list-style-type: none">• HDR or SSDR storage medium with the NC software• SIK component (System Identification Key) for enabling the control loops and software options <p>The following HSCI components are necessary for operation of the iTNC 530:</p> <ul style="list-style-type: none">• MC main computer• Controller unit• PLB 62xx PLC input/output unit (system PL; integrated in UEC)• MB 720 machine operating panel (integrated in TE 7x5) or PLB 6001 HSCI adapter for connection of an OEM machine operating panel
Interfaces	<p>The standard MC main computers feature USB 3.0, RS-232-C and Ethernet interfaces for use by the end user. Connection to PROFIBUS-DP is possible via an additional module.</p>
Voltage supply	<p>24 V DC of power are supplied to the main computer and other HSCI components by the PSL 13x supply unit. For the entire HSCI system, this 24 V DC NC supply voltage is required to be safely separated voltage (PELV). It must not be connected to the 24 V DC supply voltage for PLC components (e.g. holding brakes). This 24 V DC NC is a supply voltage for electric circuits with basic insulation that must not be connected to each other or mixed with safely separated electric circuits.</p>
Export version	<p>Because the entire NC software is saved on the memory card (HDR or SSDR), no export version is required for the main computer itself. Export versions are available only for the easily replaceable storage medium and the SIK component.</p>

Various versions of the MC main computer are available:

- For installation in the **operating panel**
The MC 7x22 and the BF visual display unit (15") form one unit, and are installed directly in the operating panel.
Advantage: except for the power supply line, only one HSCI connecting cable to the electrical cabinet is necessary.
- For installation in the **electrical cabinet**
The MC 6x41 is installed in the electrical cabinet. HSCI, USB and HDL cables to the operating panel are required as control lines.
- For installation in the **operating panel or electrical cabinet**
Because the SSDR solid state disk is used as a storage medium, the MC 6542 can be universally integrated. HSCI, USB and HDL cables to the operating panel are required as control lines.

The main computers listed are supported as of NC software 60642x-04. These MC main computers cannot be run on earlier software versions.



MC 6x41



MC 6542



MC 7x22 with main computer installed on the back

	To be installed in	Memory medium	Processor	RAM memory	Power loss	Weight	
MC 7422	Operating panel	SSDR	Intel Celeron 1047, 1.4 GHz, dual-core	2 GB	52 W	7.5 kg	ID 1039537-01
MC 7522	Operating panel	SSDR	Intel Core i7-3 1.7 GHz, dual-core	4 GB	60 W	7.5 kg	ID 1071597-01
MC 6542	Operating panel or electrical cabinet	SSDR	Intel Core i7-3 1.7 GHz, dual-core	4 GB	48 W	4.0 kg	ID 1081188-01
MC 6441	Electrical cabinet	HDR	Intel Celeron 1047, 1.4 GHz, dual-core	2 GB	40 W	4.0 kg	ID 1054739-01
MC 6541	Electrical cabinet	HDR	Intel Core i7-3 1.7 GHz, dual-core	4 GB	48 W	4.0 kg	ID 1081185-01
MC 6641	Electrical cabinet	HDR	Intel Core i7-3 2.1 GHz, quad-core	4 GB	75 W	4.0 kg	ID 811550-01

Options

The capabilities of the iTNC 530 can also be adapted retroactively with options to meet new requirements. These options are described on page 13. They are enabled by entering keywords based on the SIK number, and are saved in the SIK component. Please indicate your SIK number when ordering new options.

Memory medium

The storage medium is removable and must be ordered separately from the main computer. It contains the NC software 60642x-04. Depending on the main computer, the HDR hard disk or the SSDR solid state disk is used as a storage medium. The NC software is based on the HEIDENHAIN HEROS 5 operating system.

HDR hard disk

Free capacity	144 GB
For main computer	MC 6441, MC 6541, MC 6641
Export license required	ID 682272-04
No export license required	ID 682272-54

SSDR solid state disk

Free capacity	21 GB
For main computer	MC 6542, MC 7422, MC 7522
Export license required	ID 736591-04
No export license required	ID 736591-54



HDR hard disk



SSDR solid state disk

SIK component

The SIK component contains the **NC software license** for enabling control loops and software options. It gives the main computer an unambiguous ID code—the SIK number. The SIK component is ordered and shipped separately. It must be inserted in a special slot in the MC main computer.

The SIK component with the NC software license is available in various versions, depending on the enabled control loops and options. Further control loops – up to the maximum number available (see Controller unit) – can be enabled later by entering a keyword. HEIDENHAIN provides the keyword, which is based on the SIK number.

When ordering, please indicate the SIK number of your control. When the keywords are entered in the control, they are saved in the SIK component. This enables and activates the options. Should service become necessary, the SIK component must be inserted in the replacement control to enable all required options.



SIK component

Master keyword (general key)

There is a master keyword (general key) for putting the iTNC 530 into service that will unlock all options for a duration of 90 days. After this period, only those options with the correct keywords will be active. The general key is activated via a soft key.

TNCkeygen
(accessory)

TNCkeygen is a collection of PC software tools for generating time-limited enabling keys for HEIDENHAIN controls.

OEM Key Generator is used to generate enabling keys for software options by entering the SIK number, the option to be enabled, the duration and a manufacturer-specific password. The enabling period is limited to 10 to 90 days. Each option can only be enabled once. Option enabling is independent of the general key.

The **OEM daily key generator** generates an enabling key for the protected area of the machine tool builder. This grants the operator access to the area on the day the key was generated.

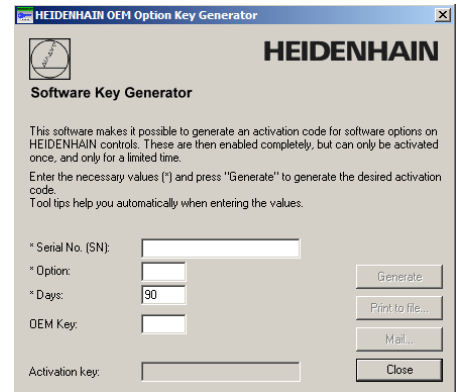

Feature content
level (FCL)

On the iTNC 530, error fixes and software improvements were separated from each other as of NC software 34049x02. **Error fixes** are usually free of charge and contained in updates of the NC software. In contrast, **software improvements** are available for a fee. They are offered as "feature upgrades" and are enabled via the Feature Content Level (FCL) option (ID 529969-01). The features in a feature content level are listed in *User functions*. For the current NC software 60642x-xx, there are not yet any FCL software improvements that are subject to a fee.

NC software license and enabling of control loops depending on the CC

Active control loops	Recommended combinations						NC software license			Included options
	CC 6106	CC 6108	CC 6110	2 x CC 6106	CC 6106 + CC 6108	2 x CC 6108	Without software option	Incl. option 8	Incl. options 8 and 9	
							SIK	SIK	SIK	
4	✓						ID 586084-20 <i>ID 586084-70</i>	ID 586084-09 <i>ID 586084-59</i>	ID 586084-01 <i>ID 586084-51</i>	-
5	✓						ID 586084-24 <i>ID 586084-74</i>	ID 586084-17 <i>ID 586084-67</i>	ID 586084-02 <i>ID 586084-52</i>	0
6	✓						ID 586084-25 <i>ID 586084-75</i>	ID 586084-18 <i>ID 586084-68</i>	ID 586084-03 <i>ID 586084-53</i>	0, 1
7		✓					ID 586084-26 <i>ID 586084-76</i>	ID 586084-19 <i>ID 586084-69</i>	ID 586084-04 <i>ID 586084-54</i>	0, 1, 2
8		✓					ID 586084-27 <i>ID 586084-77</i>	ID 586084-23 <i>ID 586084-73</i>	ID 586084-05 <i>ID 586084-55</i>	77
9			✓				Only through subsequent enabling of control loops (additional axes)		ID 586084-06 <i>ID 586084-56</i>	77, 0
10			✓			ID 586084-07 <i>ID 586084-57</i>			77, 0, 1	
11				✓		ID 586084-10 <i>ID 586084-60</i>			77, 0, 1, 2	
12				✓		ID 586084-11 <i>ID 586084-61</i>			78	
13					✓	ID 586084-12 <i>ID 586084-62</i>			78, 0	
14					✓	ID 586084-13 <i>ID 586084-63</i>			78, 0, 1	
15						✓			ID 586084-14 <i>ID 586084-64</i>	78, 0, 1, 2
16						✓			ID 586084-15 <i>ID 586084-65</i>	77, 78
17 - 20							Only through subsequent enabling of control loops (additional axes)		77, 78, 0...3	

(Italics: Export version)

Enabling further control loops

Further control loops can be enabled either as groups or individually. The combination of control-loop groups and individual control loops makes it possible to enable any number of control loops. Up to **20 control loops** are possible.

Control-loop groups	Option	
4 additional control loops	77	ID 634613-01
8 additional control loops	78	ID 634614-01

Individual control loops	Option	
1st additional control loop	0	ID 354540-01
2nd additional control loop	1	ID 353904-01
3rd additional control loop	2	ID 353905-01
4th additional control loop	3	ID 367867-01
5th additional control loop	4	ID 367868-01
6th additional control loop	5	ID 370291-01
7th additional control loop	6	ID 370292-01
8th additional control loop	7	ID 370293-01

Controller unit

Controller unit Due to the very short cycle times of the position, speed and current controllers, the controller units from HEIDENHAIN are equally suited for conventional drives, for direct drives (linear motors, torque motors) and for HSC spindles. They permit a high loop gain and short reaction times to changing machining forces, and so make the high contour accuracy and surface quality of the workpiece possible.

Single speed
Double speed

Single-speed control loops are usually sufficient for linear or torque motors and for conventional axes. **Double-speed control loops** (option 49) are preferred for HSC spindles and axes that are difficult to control. In the default setting, all axes are set to single speed. Each axis that is switched from single speed to double speed can reduce the number of available control loops by one. PWM frequencies greater than 5 kHz require double-speed control loops, for which option 49 must be enabled.

Cycle times	With f_{PWM}	Current controller	Speed controller		Position controller
			Single-speed	Double-speed	
	3333 Hz	150 μs	300 μs	150 μs	Same as speed controller
	4000 Hz	125 μs	250 μs	125 μs	
	5000 Hz	100 μs	200 μs	100 μs	
	6666 Hz ¹⁾	75 μs	150 μs	150 μs	
	8000 Hz ¹⁾	60 μs	125 μs	125 μs	
	10000 Hz ¹⁾	50 μs	100 μs	100 μs	

¹⁾ Possible only with option 49

Number of control loops The number of enabled control loops depends on the SIK (see *Main computer*), or on additionally enabled control loops, which can also be ordered as needed later.

Versions

- Modular CC 61xx controller units with PWM interface to the inverters
- Compact UEC/UMC inverters with integrated controller unit

Controller units, main computers and inverters operate in any desired combination.

CC 61xx

The **CC 61xx** controller units feature:

- Position controller, speed controller, current controller
- HSCI interfaces
- PWM interfaces to the UM, UR, UE power modules
- Interfaces to the speed and position encoders
- Interfaces for power supply (via inverter oder PSL 135)
- SPI interfaces for expansion modules (e. g. CMA-H)

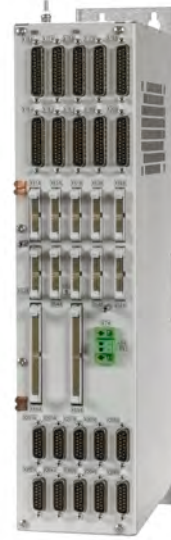

CC 6110

	CC 6106	CC 6108	CC 6110
Digital control loops	Max. 6 (single speed)	Max. 8 (single speed)	Max. 10 (single speed)
Speed inputs	6 x 1 V _{PP} or EnDat 2.2	8 x 1 V _{PP} or EnDat 2.2	10 x 1 V _{PP} or EnDat 2.2
Position inputs	6 x 1 V _{PP} or EnDat 2.2	8 x 1 V _{PP} or EnDat 2.2	10 x 1 V _{PP} or EnDat 2.2
PWM outputs	6	8	10
Weight	4.1 kg	4.7 kg	4.8 kg (10.6 lb)
	ID 662636-xx	ID 662637-xx	ID 662638-xx

For more than 10 control loops, an HSCI line is used to combine the controller units. For example:

CC 6106 + CC 6106 for up to 12 control loops

CC 6106 + CC 6108 for up to 14 control loops

CC 6110 + CC 6108 for up to 18 control loops

Constraints:

- Max. 20 control loops for max. 18 axes + 2 spindles can be activated (second spindle can be controlled alternately with the first spindle).
- Up to four drive-control motherboards are permissible in the HSCI system (CC 6106 has one motherboard, CC 6108/CC 6110 each has two motherboards).

Ribbon cable for supply voltage

Additional ribbon cables are necessary if multiple CC 6xxx units are combined.

Combination	Length	Dimension c	
2 x CC 6108, or 2 x CC 6110, or CC 6108 and CC 6110	300 mm ¹⁾	26.5 mm	ID 325816-22
2 x CC 6106	100 mm	31.5 mm	ID 325816-24

¹⁾ In order to reduce the voltage drop, the long ribbon cable is led doubled.

The short ribbon cables included in delivery are not necessary for combinations with CC 6108 and/or CC 6110. They are only necessary for connecting sockets X69 A and X69 B if the CC units are used separately.

For more information about connecting a CC 6xxx to a supply unit via ribbon cables, see the *Inverter Systems* brochure.



UEC 11x

The UEC 11x compact inverters not only include the inverter, but also a controller with PLC inputs and outputs and an integrated braking resistor. They form a complete solution for machines with a limited number of axes and low power demands.

Controllers

- Position controller, speed controller, current controller
- HSCI interface
- Interfaces to the speed and position encoders

Inverters

- Power electronics
- Connections for axis motors and spindle motor
- Braking resistor
- Connections for motor holding brakes
- Additional DC-link connection on the front for connection of a PSL 130

System PL

- Interfaces for one workpiece touch probe and one tool touch probe
- Integrated PLC (expandable with PL 61xx)
UEC 11x: 38 free inputs, 23 free outputs (7 of which can be switched off)
UEC 11x FS: 38 free inputs, 28 free outputs (7 of which can be switched off), 8 free FS inputs, 8 free FS outputs
- Configuration with IOconfig PC software



UEC 113

		UEC 111/UEC 112/UEC 113		
Controllers		4/5/6 digital control loops		
Speed inputs		4/5/6 x 1 V _{pp} or EnDat 2.2		
Position inputs		4/5/6 x 1 V _{pp} or EnDat 2.2		
Inverters		2/3/4 axes	1 axis	Spindle
Rated current I_N/ maximum current I_{max}¹⁾ at a PWM frequency of	3333 Hz	6.0/12.0 A	9.0/18.0 A	24.0/36.0 A
	4000 Hz	5.5/11.0 A	8.3/16.5 A	22.0/33.0 A
	5000 Hz	5.0/10.0 A	7.5/15.0 A	20.0/30.0 A
	6666 Hz	4.2/8.4 A	6.3/12.6 A	16.8/25.2 A
	8000 Hz	3.6/7.3 A	5.5/11.0 A	14.6/21.9 A
	10000 Hz	3.0/6.0 A	4.6/9.2 A	12.2/18.3 A
Supply voltage		400 V 3 AC (± 10 %); 50 Hz or 480 V 3 AC (+6 %/-10 %); 60 Hz		
Rated power of DC link		14 kW		
Peak power²⁾ of DC link		18 kW / 25 kW		
Power loss at I_N		≈ 450 W		
DC-link voltage		565 V DC		
Integral braking resistance³⁾		2.1 kW / 27 kW		
Power pack for HSCI components		24 V DC / 3.5 A		
Module width		150 mm		
Weight		≈ 14 kg		
Functional safety		-	✓	
UEC 111		ID 1081002-xx	ID 1075825-xx	
UEC 112		ID 1081003-xx	ID 1075826-xx	
UEC 113		ID 828471-xx	ID 1038694-xx	

¹⁾ Axes: 0.2 s cyclic duration factor for duty cycle time of 10 s with 70 % rated current preload
Spindle: 10 s cyclic duration factor for duty cycle time of 60 s with 70 % rated current preload

²⁾ 1st value: 40 % cyclic duration factor for 10 minutes duty cycle time (S6-40 %)
2nd value: 4 s cyclic duration factor for 20 seconds duty cycle time

³⁾ 1st value: Continuous duty
2nd value: Peak power (1.5 % cyclic duration factor for 120 seconds duty cycle time)

UMC 11x

The UMC 111 is a compact inverter with integrated controller unit and PLC inputs/outputs. As opposed to the UEC, it is used exclusively for controlling axis motors and is powered by an external DC link. The UMC automatically enables the control loops needed for auxiliary axes. No additional options are required.

Please note: The UMC does not increase the number of possible axes. Interpolation with NC axes is not possible.

Controllers

- Position controller, speed controller, current controller
- HSCI interface
- Interfaces to the speed encoders

Inverters

- Power electronics
- Connections for axis motors
- Connections for motor holding brakes

System PL

- Interfaces for one workpiece touch probe and one tool touch probe with signal transmission by cable
- Integrated PLC, expandable with PL 61xx
UMC 111: 38 free inputs, 23 free outputs (7 of which can be switched off)
UMC 111 FS: 38 free inputs, 28 free outputs (7 of which can be switched off)
 8 FS inputs, 8 FS outputs
- Configuration with IOconfig PC software



UMC 111

		UMC 111
Controllers		4 digital control loops
Speed inputs		4 x 1 V _{PP} or EnDat 2.2
Inverters		4 axes
Rated current I_N/ maximum current I_{max}¹⁾ at a PWM frequency of	3333 Hz	9.0/18.0 A
	4000 Hz	8.3/16.5 A
	5000 Hz	7.5/15.0 A
	6666 Hz	6.3/12.6A
	8000 Hz	5.5/11.0 A
	10000 Hz	4.6/9.2 A
Power loss at I_N		≈ 300 W
DC-link voltage		565 V DC or 650 V DC
24 V PLC current consumption		24 V DC / 2 A
Module width		150 mm
Weight		≈ 11 kg
UMC 111		ID 736435-xx
UMC 111 FS		ID 664231-xx

¹⁾ Axes: 0.2 s cyclic duration factor for duty cycle time of 10 s with 70 % rated current preload
 Spindle: 10 s cyclic duration factor for duty cycle time of 60 s with 70 % rated current preload

15" screen and keyboard

BF 750 color flat-panel display

- Power supply: 24 V DC / \approx 50 W
- **15.1-inch**; 1024 x 768 pixels
- HDL interface to the MC 6xxx
- 8 horizontal soft keys, 6 vertical soft keys for PLC
- Soft-key row switchover
- Selectable screen layout
- Operating mode switchover
- USB port with cover cap on front
- Integrated USB hub with four USB interfaces on the rear

BF 750 ID 785080-01
Weight \approx 4 kg



BF 750

TE 730 keyboard

- For BF 750, MC 7422 or MC 7522
- Axis keys
- The keys for axes IV and V are exchangeable snap-on keys.
- Contouring keys
- Operating mode keys
- ASCII keyboard
- Spindle-speed and feed-rate override potentiometer
- USB interface to the MC
- Touchpad

TE 730 ID 805489-01
Weight \approx 2.4 kg



TE 730

TE 720 keyboard

Same features as TE 730 but without touchpad

TE 720 ID 805488-01

TE 735 keyboard unit with integrated machine operating panel

- For BF 750, MC 7422 or MC 7522
- NC keyboard same as TE 730
- USB interface to the MC main computer
- Machine operating panel (same as MB 720)
- HSCI interface

TE 735 ID 771898-01
TE 735 FS ID 805493-01
Weight \approx 3.4 kg



TE 735

MB 720 machine operating panel

- Power supply 24 V DC / \approx 4 W
- Suitable for BF 750
- 36 exchangeable snap-on keys with status LED, freely definable via PLC (assignment according to PLC basic program: 12 axis keys, spindle start, spindle stop, 22 other function keys)
- Other operating elements: NC start¹⁾, NC stop¹⁾, emergency stop button, control voltage on¹⁾; 2 holes for additional keys or keylock switches
- HSCI interface
- MB 720: 7 free PLC inputs and 5 free PLC outputs
MB 720 FS: 4 free FS inputs and 5 free PLC outputs; and dual-channel FS inputs for emergency stop and permissive buttons of the handwheel.

¹⁾ Keys illuminated, addressable via PLC

MB 720 ID 784803-01
MB 720 FS ID 805474-01
Weight \approx 1 kg



MB 720

19" screen and keyboard

BF 760 color flat panel display

- Power supply: 24 V DC / \approx 65 W
- **19-inch**; 1280 x 1024 pixels
- HDL interface to the MC 6xxx
- 10 horizontal NC soft keys, 8 + 10 vertical soft keys for PLC
- Soft-key row switchover
- Selectable screen layout
- Operating mode switchover
- Integrated USB hub with six USB interfaces on the rear

BF 760 ID 732589-01
Weight \approx 7.8 kg



BF 760

TE 740 keyboard

- Suitable for BF 760 (19" design)
- Axis keys
- The keys for axes IV and V are exchangeable snap-on keys.
- Contouring keys
- Operating mode keys
- ASCII keyboard
- Spindle-speed, feed-rate and rapid-traverse override potentiometers
- USB interface to the MC main computer
- Touchpad
- USB port with cover cap on front

A PLB 6001 is required for connection of an OEM-specific machine operating panel.

TE 740 ID 886546-01
Weight \approx 3.2 kg



TE 740

TE 745 keyboard unit with integrated machine operating panel

Same as TE 740, but with integrated machine operating panel

- Power supply: 24 V DC / \approx 4 W
- 36 exchangeable snap-on keys with status LEDs, freely definable via PLC
- 36 exchangeable snap-on keys with status LED, freely definable via PLC (assignment according to PLC basic program: 12 axis keys, spindle start, spindle stop, 22 other function keys)
- Other operating elements: NC start¹⁾, NC stop¹⁾, emergency stop button, control voltage on¹⁾; 2 holes for additional keys or keylock switches
- Connection for HR handwheel
- HSCI interface
- TE 745: 7 free PLC inputs and 5 free PLC outputs
TE 745 FS: 4 free FS inputs and 5 free PLC outputs; and dual-channel FS inputs for emergency stop and permissive buttons of the handwheel.

¹⁾ Keys illuminated, addressable via PLC

TE 745 ID 679817-01
TE 745 FS ID 805482-01
Weight \approx 4.3 kg



TE 745

PL 6000 PLC input/output systems with HSCI

PL 6000

The PLC inputs and outputs are available via external modular PL 6000 PLC input/output systems. They consist of a basic module and one or more input/output modules. A total maximum of 1000 inputs/outputs is supported. The PL 6000 units are connected to the MC main computer via the HSCI interface. The PL 6000 units are configured with the IOconfig PC software.



PLB 62xx

Basic modules

There are basic modules with **HSCI interface** available for 4, 6 or 8 I/O modules. They are mounted on standard NS 35 rails (DIN 46 227 or EN 50 022).

Supply voltage	24 V DC
Power consumption ¹⁾	≈ 48 W at 24 V DC NC ≈ 21 W at 24 V DC PLC
Weight	0.36 kg (bare)

¹⁾ PLB 6xxx completely filled, incl. TS, TT. For more details regarding power supply for 24 V DC NC, see *Power supply for HSCI components*.

System PL

- Necessary once for each control system (except with UEC)
- Includes connections for TS and TT touch probes, as well as TL
- Safety-relevant inputs/outputs
- *Without FS*: 12 free inputs, 7 free outputs
With FS: 6 free FS inputs, 2 free FS outputs

PLB 6204	for 4 I/O modules	ID 591832-03
PLB 6204 FS	for 4 I/O modules	ID 586789-03
PLB 6206	for 6 I/O modules	ID 630054-03
PLB 6206 FS	for 6 I/O modules	ID 622721-03
PLB 6208	for 8 I/O modules	ID 630055-03
PLB 6208 FS	for 8 I/O modules	ID 620927-03

Expansion PL

For connection to the system PL to increase the number of PLC inputs/outputs

PLB 6104	for 4 I/O modules	ID 591828-03
PLB 6104 FS	for 4 I/O modules	ID 590479-03
PLB 6106	for 6 I/O modules	ID 630058-03
PLB 6106 FS	for 6 I/O modules	ID 804755-01
PLB 6108	for 8 I/O modules	ID 630059-03
PLB 6108 FS	for 8 I/O modules	ID 804756-01

Up to seven PLB 6xxx can be connected to the control. The maximum cable length results from the maximum permissible length of the HSCI chain of 70 m.

I/O modules for HSCI

There are I/O modules with digital and analog inputs and outputs. For partially occupied basic modules, the unused slots must be occupied by an empty housing.

PLD-H 16-08-00	I/O module with 16 digital inputs and 8 digital outputs	ID 594243-02
PLD-H 08-16-00	I/O module with 8 digital inputs and 16 digital outputs	ID 650891-02
PLD-H 08-04-00 FS	I/O module with 8 digital FS inputs and 4 digital FS outputs	ID 598905-02
PLD-H 04-08-00 FS	I/O module with 4 digital FS inputs and 8 digital FS outputs	ID 727219-02

Total current	Outputs 0 to 7: ≤ 2 A per output (≤ 8 A simultaneously)
Power output	Max. 200 W
Weight	0.2 kg

PLA-H 08-04-04	Analog module for PL 6xxx with <ul style="list-style-type: none">• 8 analog inputs, ± 10 V• 4 analog outputs, ± 10 V• 4 analog inputs for PT 100 thermistors	ID 675572-02
Weight	0.2 kg	

Empty housing

For unused slots ID 383022-01

IOconfig (accessory)

PC software for configuring HSCI and PROFIBUS components

PL 550 PLC input/output system for PROFIBUS-DP

PL 550

PLC inputs and outputs are also available via the external modular PL 550 PLC input/output system. It consists of a basic module and one or more I/O modules, and is connected to the MC main computer via the PROFIBUS-DP interface. The PLC I/O modules are configured with the PC software IOconfig. The additional module for PROFIBUS-DP (Page 34) must be installed in the MC before the PLB 550 is connected to the control.



PL 550

Basic module

Basic module with PROFIBUS-DP interface
The PLB 550 has slots for four I/O modules. It serves as a PROFIBUS slave. A total of 32 slaves can be connected to the MC with integrated PROFIBUS interface board (PROFIBUS single master). They are mounted on standard NS 35 rails (DIN 46 227 or EN 50 022).

PLB 550	ID 507872-01
Supply voltage	24 V DC
Power consumption	≈ 20 W
Weight	0.36 kg (bare)

I/O modules

The I/O modules consist of one module with digital inputs/outputs and one analog module. For partially occupied basic modules, the unused slots must be occupied by an empty housing.

PLD 16-8	ID 360916-11
I/O module for PL 5x0 with 16 digital inputs and 8 digital outputs.	

The max. power output per module is 200 W. A load of up to 2 A can be placed on each output. No more than four outputs may be loaded with 2 A at any given time.

Weight	0.2 kg
--------	--------

PLA 4-4	ID 366423-01
Analog module for PL 5x0 with 4 analog inputs for PT 100 thermistors 4 analog inputs for ± 10 V	
Weight	0.2 kg

Empty housing

For unused slots	ID 383022-01
------------------	--------------

IOconfig (accessory)

PC software for configuring HSCI and PROFIBUS components

Accessories

Power supply for HSCI components

PSL 13x

To power the HSCI components, HEIDENHAIN offers the PSL 13x power supply unit. Either line voltage and DC-link voltage or only line voltage is provided to the PSL 13x. The PSL 13x provides the safely separated 24 V DC NC power supply required for the HSCI components by EN 61800-5-1. The NC supply voltage and the PLC supply voltage are separated from each other by basic insulation.

Supply voltage	Line voltage 400 V AC \pm 10 % 50 Hz and DC-link voltage 400 V DC to 750 V DC Power consumption \leq 1000 W	
Outputs	NC: 24 V DC / \leq 20 A (double insulation from line power) 5 V DC / \leq 16 A (only for PSL 135) electrically connected with 24 V DC NC	
	PLC: 24 V DC / \leq 20 A (basic insulation from line power)	PSL 130
Total:	\leq 32 A / 750 W	



The **PSL 130** serves as a 24 V DC power supply unit for supplying the HSCI components. If a UEC controller unit is used, then the PSL 130 is not necessary if the total current consumption of the connected HSCI components does not exceed 3.5 A.

HSCI components		Current consumption 24 V DC NC
Main computer	MC 6441 MC 6541, MC 6542 MC 6641 MC 7422 MC 7522	1.7 A 2.0 A 3.2 A 2.2 A 2.5 A
Machine operating panel	PLB 6001 MB 7x0	0.2 A (without handwheel) 0.2 A (without handwheel)
Keyboard	TE 7x5 (MB integrated)	0.2 A (without handwheel)
PLC inputs/outputs	PLB 62xx PLB 61xx PLD PLA	0.3 A (without touch probe) 0.2 A 0.05 A 0.1 A
Screen	BF 750 BF 760	2.1 A 2.5 A
Handwheels	HR 520 HRA 551 FS + HR 550 FS HR 410 HR 130 HRA 110 + 3 x HR 150	0.05 A 0.5 A (while charging) 0.05 A 0.05 A 0.2 A
Touch probes	See specifications of the touch probes	

The **PSL 135** has an additional 5 V DC output and is therefore suited for supplying the CC controller unit and the MC main computer. It may be necessary for a double-row configuration.

	Module width	Degree of protection	Weight	
PSL 130	50 mm	IP 20	2.1 kg	ID 575047-04
PSL 135	50 mm	IP 20	2.5 kg	ID 627032-03

HSCI adapter for OEM machine operating panel

PLB 6001

The PLB 6001 HSCI adapter is required in order to connect an OEM-specific machine operating panel to the iTNC 530. The spindle-speed and feed-rate override potentiometers of the TE 7xx and the HR handwheel are also connected to this adapter.

- HSCI interface
- Connection for HR handwheel
- Inputs/outputs for keys/key illumination
 - Without FS:* Terminals for 72 inputs and 40 outputs
 - With FS:* Terminals for 36 FS inputs and 40 outputs
- Screw fastening or top-hat-rail mounting
- Configuration of the PLC inputs/outputs with the IOconfig computer software

PLB 6001	ID 668792-01
PLB 6001 FS	ID 722083-01
Weight	≈ 1.2 kg

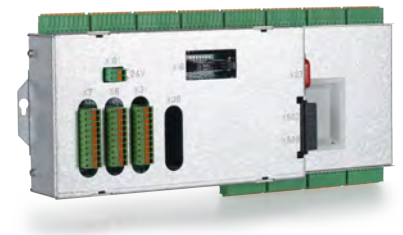

PLB 6001

Additional modules

Overview

The additional modules are directly connected to the HSCI control system through a slot on the MC main computer, CC controller unit or UEC/UMC inverter.

Module for analog axes

Digital drive designs sometimes also require analog axes or spindles. The additional module CMA-H 04-04-00 (Controller Module Analog—HSCI) makes it possible to integrate analog servo drives in an HSCI system.

The CMA-H is connected to the HSCI control system through a slot on the underside of the CC or UEC. Every controller unit has slots for two boards. The CMA-H does not increase the total number of available axes: every analog axis used reduces the number of available digital control loops by one. Analog control loops also need to be enabled on the SIK. The analog control-loop outputs can only be accessed via the NC, and not via the PLC.

Additional module for analog axes/spindles

- Expansion board for CC 61xx or UEC controller units
- 4 analog outputs, ± 10 V for axes/spindle
- Spring-type plug-in terminals

CMA-H 04-04-00

ID 688721-01



CMA-H 04-04-00

Module for PROFIBUS-DP

An expansion board can be used to provide the iTNC 530 with a PROFIBUS interface at any time. This makes the connection to a PROFIBUS-DP field bus system possible.

The PROFIBUS module is integrated in the control system by using a slot in the MC. The interface is configured with IOconfig.

Additional module for PROFIBUS-DP

- Expansion board for the MC main computer
- Connection for D-sub connector (female) 9-pin

PROFIBUS-DP additional module

ID 828539-01



Module for PROFIBUS-DP

Touch probes

Overview

Touch probes for tool and workpiece measurement are connected via the system PL 62xx or the UEC/UMC. These touch probes generate a trigger signal that saves the current position value to the NC. For more information on the touch probes, ask for our brochure titled *Touch Probes*.

Workpiece measurement

The TS touch trigger probes have a stylus for probing workpieces. The HEIDENHAIN controls provide standard routines for datum setting and workpiece measurement and alignment. The touch probes are available with various taper shanks. Assorted styli are available as accessories.

Touch probes with **cable connection for signal transmission** for machines with manual tool change:

TS 260 New generation touch probe for NC machines



TS 260

Touch probe with **radio and infrared transmission** for machines with automatic tool change (see page 36 for the fitting transmitter/receiver unit):

TS 460

New generation touch probe with compact dimensions

- Hybrid technology: Signal transmission via radio and infrared signals
- Large transmission range and long operating time
- Mechanical collision protection and thermal decoupling



TS 460

Touch probes with **infrared signal transmission** for machines with automatic tool change (see page 36 for the fitting transmitter/receiver unit):

TS 444

Compact dimensions, battery-free—power supply through integrated air turbine generator over central compressed air supply

TS 642

Activation via switch in taper shank

TS 740

High probing accuracy and reproducibility, low probing force

Tool measurement

The touch probes for tool measurement from HEIDENHAIN are suited for probing stationary or rotating tools directly on the machine. The iTNC 530 has standard routines for measuring the length and diameter of the tool as well as the individual teeth. The iTNC 530 automatically saves the results of measurement in a tool table. It is also possible to measure tool wear between two machining steps. The iTNC 530 compensates the changed tool dimensions automatically for subsequent machining or replaces the tool after a certain limit—as for example after tool breakage.

With the triggering **TT touch probes**, the disk-type probe contact is deflected from its rest position upon contact with a stationary or rotating tool, sending a trigger signal to the iTNC 530 control.

TT 160 New generation touch probe; signal transmission to the control over connecting cable



TT 160

TT 460 Next generation touch probe, hybrid technology: signal transmission via radio or infrared beam (see below for fitting transmitter/receiver unit)

TL Micro/TL Nano The **TL laser systems** operate without any contact. A laser beam probes the length, diameter or contour of the tool. Special measuring cycles in the iTNC 530 evaluate the information.



Transceiver unit

The radio or infrared transmission is established between the TS or TT touch probe and the SE transceiver unit.

SE 660 For radio or infrared transmission (hybrid technology); shared SE for TS 460 and TT 460; next generation

SE 540 For infrared transmission; integration in the spindle head

SE 642 For infrared transmission; shared SE for TS and TT

The following combinations are possible:

	SE 660	SE 540	SE 642
TS 444	-	Infrared	Infrared
TS 460	Radio/infrared	Infrared	Infrared
TS 642	-	Infrared	Infrared
TS 740	-	Infrared	Infrared
TT 460	Radio/infrared	Infrared	Infrared



SE 660

Electronic handwheels

Overview

The standard iTNC 530 supports the use of electronic handwheels.

- **HR 550 FS** wireless handwheel, or
- **HR 410** or **HR 520** portable handwheel, or
- **HR 130** panel-mounted handwheel
- Up to three **HR 150** panel-mounted handwheels via **HRA 110**

Two handwheels or HRA handwheel adapters, one of which can be an HR 550 FS, can be connected to the MB machine operating panel, the MC main computer or the PLB 6001 adapter for HSCI. Handwheels with functional safety are cross-circuit proof thanks to the special permissive key logic.

HR 410

Portable electronic handwheel with

- Keys for actual-position capture and the selection of 5 axes
- Keys for traverse direction and three preset feed rates
- Three keys with machine functions (see below)
- Emergency stop button and two permissive buttons (24 V)
- Magnetic holding pads

All keys are designed as snap-on keys and can be replaced by keys with other symbols (see *Snap-on keys*).

	Keys	W/o detent	With detent
HR 410	FCT A, FCT B, FCT C	ID 296469-53	–
	Spindle right/left/stop	ID 296469-54	–
	NC start/stop, spindle start (for PLC basic program)	ID 296469-55	ID 535220-05
HR 410 FS	FCT A, FCT B, FCT C	ID 337159-11	ID 578114-01
	NC start/stop, spindle start (for PLC basic program)	ID 337159-21	ID 578114-11

Weight ≈ 1 kg



HR 410

HR 520

Portable electronic handwheel with

- Display for operating mode, actual position value, programmed feed rate and spindle speed, error messages
- Override potentiometer for feed rate and spindle speed
- Selection of axes via keys or soft keys
- Actual position capture
- NC start/stop
- Spindle on/off
- Keys for continuous traverse of the axes
- Soft keys for machine functions of the machine manufacturer
- Emergency stop button

	W/o detent	With detent
HR 520	ID 670302-01	ID 670303-01
HR 520 FS	ID 670304-01	ID 670305-01

Weight ≈ 1 kg



HR 520

Mount for HR 520

For fastening on machine

ID 591065-02

HR 550 FS

Electronic handwheel with wireless transmission. Display, operating elements and functions same as HR 520.

In addition:

- Functional safety
- Wireless transmission range up to 20 m (depending on environment)

HR 550 FS W/o detent ID 598515-03
 With detent ID 606622-03

Replacement battery for HR 550 FS ID 623166-xx



HR 550 FS with HRA 551 FS

HRA 551 FS

Handwheel mount for HR 550 FS

- For docking the HR 550 FS on the machine
- Integrated charger for HR 550 FS
- Connections to the control and the machine
- Integrated transmitter/receiver unit

HRA 551 FS ID 731928-02
Weight ≈ 1.0 kg

For more information, see the *HR 550 FS* Product Information sheet.

Connecting cables

	For HR 410/ HR 520	For HR 410 FS/ HR 520 FS	For HR 550 FS with HRA 551 FS	
Connecting cable (spiral cable) to HR (3 m)	✓	✓	–	ID 312879-01
Connecting cable with metal armor	✓	✓	–	ID 296687-xx
Connecting cable without metal armor	✓	✓	✓	ID 296467-xx
Adapter cable for HR/HRA to MC	✓	✓	✓ ¹⁾	ID 296466-xx
Extension cable to adapter cable	✓	✓	✓ ¹⁾	ID 281429-xx
Adapter cable for HRA to MC	–	–	✓ ²⁾	ID 749368-xx
Extension cable to adapter cable	–	–	✓ ²⁾	ID 749369-xx
Dummy plug for standard handwheels	✓	–	–	ID 271958-03
Dummy plug for handwheels with FS	–	✓	✓	ID 271958-05

¹⁾ For cable lengths up to 20 m between MB and HRA 551 FS

²⁾ For cable lengths up to 50 m between MB and HRA 551 FS

See also *Cable overview* on Page 44.

HR 130

Panel-mounted handwheel with ergonomic control knob.
It is attached to the MB 7x0 or the TE 7x5 either directly or via an extension cable.

HR 130	W/o detent	ID 540940-03
	With detent	ID 540940-01
Weight	≈ 0.7 kg	



HR 130

HR 150

Panel-mounted handwheel with ergonomic control knob for connection to the **HRA 110** handwheel adapter.

HR 150	W/o detent	ID 540940-07
	With detent	ID 540940-06
Weight	≈ 0.7 kg	



HR 150

HRA 110

Handwheel adapter for connection of up to three **HR 150** panel-mounted handwheels and two switches for axis selection and for selecting the subdivision factor. The first two handwheels are permanently assigned to axes 1 and 2. The third handwheel is assigned to the axes over a selection switch (accessory) or by machine parameters. The position of the second selection switch (accessory) is evaluated by the PLC, for example to set the proper interpolation.

HRA 110		ID 261097-04
Weight	≈ 1.5 kg	

Handwheel selection switch	With turning knob and cable	ID 270908-xx
-----------------------------------	-----------------------------	--------------



HRA 110



Handwheel selection switch

Industrial PC

Additional operating station

The additional ITC operating stations (Industrial Thin Clients) from HEIDENHAIN are convenient solutions for an additional, remote station for operating the machine or a machine unit, such as a tool-changing station. The remote operation, which was designed for the TNC, permits very simple connection of the ITC via a standard Ethernet connection with a cable of up to 100 meters.

It is surprisingly simple to connect an ITC: As soon as the TNC identifies an ITC, it provides it with a current operating system. After the ITC has been started, the complete content of the main screen is mirrored to the ITC's screen. Thanks to this Plug & Play functionality, there is no need for a configuration by the machine tool builder—if standard configuration of the X116 Ethernet interface is used, the TNC automatically integrates the ITC in the system.



ITC 755

ITC 755

The **ITC 755** is a compact additional operating station for control systems with a 15-inch or 19-inch main screen. It provides the most important function keys of the TNC in addition to an ASCII keyboard and a touch screen. The ITC 755 adjusts its resolution automatically to fit the size of the main screen. The soft keys are operated using the touch screen.

ITC 755 ID 1039527-01

ITC 750
ITC 760

Together with the TE 73x or TE 74x keyboard unit, which must be ordered separately, the **ITC 750** (15-inch screen) and **ITC 760** (19-inch screen) each make up one complete second operating station. It is operated in the same way as the TNC.

ITC 750 with 15" screen ID 1039544-01
for TE 73x
ITC 760 with 19" screen ID 827086-01
for TE 74x

IPC 6641 for Windows

With the IPC 6641 industrial PC you can start and remotely operate Windows-based applications via the TNC's user interface. The user interface is displayed on the control screen. Option 133 is required.

Since Windows runs on the industrial PC, it does not influence the NC machining process. The IPC is connected to the NC main computer via Ethernet. No second screen is necessary, since the Windows applications are displayed on the TNC's screen via remote accesses.

In addition to the IPC 6641 industrial PC, a separately ordered hard disk is required for operation. The operating systems Windows 7 or 8 can be installed on this empty data medium.

IPC 6641 ID 1039543-01
To be installed in Processor Electrical cabinet
Intel Core i7-3
2.1 GHz, quad-core
RAM memory 4 GB
Weight 4.0 kg

HDR hard disk ID 1074770-51
Empty data carrier for Windows operating system
Free capacity ≈ 160 GB









































































































IPC 6641

Snap-on keys for HR

Overview

The snap-on keys make it easy to replace the key symbols. In this way, the HR handwheel can be adapted to different requirements. The snap-on keys are available in packs of 5 keys.











Axis keys Orange		ID 330816-42		ID 330816-24		ID 330816-43		ID 330816-37
		ID 330816-26		ID 330816-36		ID 330816-38		
		ID 330816-23		ID 330816-25		ID 330816-45		
Gray		ID 330816-95		ID 330816-69		ID 330816-0W		ID 330816-0R
		ID 330816-96		ID 330816-0G		ID 330816-0V		ID 330816-0D
		ID 330816-97		ID 330816-0H		ID 330816-0N		ID 330816-0E
		ID 330816-98		ID 330816-71		ID 330816-0M		ID 330816-65
		ID 330816-99		ID 330816-72		ID 330816-67		ID 330816-66
		ID 330816-0A		ID 330816-63		ID 330816-68		ID 330816-19
		ID 330816-0B		ID 330816-64		ID 330816-21		ID 330816-16
		ID 330816-0C		ID 330816-18		ID 330816-20		ID 330816-0L
		ID 330816-70		ID 330816-17		ID 330816-0P		ID 330816-0K
	Machine functions		ID 330816-0X		ID 330816-75		ID 330816-0T	
		Black ID 330816-1Y		ID 330816-76		ID 330816-81		ID 330816-87
		Black ID 330816-30		ID 330816-77		ID 330816-82		ID 330816-88
		Black ID 330816-31		ID 330816-78		ID 330816-83		ID 330816-94
		Black ID 330816-32		ID 330816-79		ID 330816-84		ID 330816-0U
		ID 330816-73		ID 330816-80		ID 330816-89		ID 330816-91
		ID 330816-74		ID 330816-0S		ID 330816-85		ID 330816-3L
Spindle functions			Red ID 330816-08		ID 330816-40		Red ID 330816-47	
		Green ID 330816-09		ID 330816-41		Green ID 330816-46		ID 385530-5X
Other keys		Black ID 330816-01		Red ID 330816-50		ID 330816-90		ID 330816-93
		ID 330816-61		ID 330816-33		Black ID 330816-27		ID 330816-0Y
		Green ID 330816-11		ID 330816-34		Black ID 330816-28		Black ID 330816-4M
		Red ID 330816-12		ID 330816-13		Black ID 330816-29		ID 330816-3M
		Green ID 330816-49		Green ID 330816-22		ID 330816-92		ID 330816-3N

Snap-on keys for control







































Overview

The snap-on keys make it easy to replace the key symbols. In this way, the keyboard can be adapted to different requirements. The snap-on keys are available in packs of 5 keys.









































Keys Orange

	ID 679843-31		ID 679843-54		ID 679843-C8		ID 679843-D4
	ID 679843-32		ID 679843-55		ID 679843-C9		ID 679843-35
	ID 679843-53		ID 679843-88		ID 679843-D3		



















Gray

	ID 679843-03		ID 679843-13		ID 679843-93		ID 679843-B9
	ID 679843-04		ID 679843-14		ID 679843-94		ID 679843-C1
	ID 679843-05		ID 679843-43		ID 679843-B1		ID 679843-C2
	ID 679843-06		ID 679843-44		ID 679843-B2		ID 679843-C3
	ID 679843-07		ID 679843-67		ID 679843-B3		ID 679843-C4
	ID 679843-08		ID 679843-68		ID 679843-B4		ID 679843-C5
	ID 679843-09		ID 679843-69		ID 679843-B5		ID 679843-D9
	ID 679843-10		ID 679843-70		ID 679843-B6		ID 679843-E1
	ID 679843-11		ID 679843-91		ID 679843-B7		
	ID 679843-12		ID 679843-92		ID 679843-B8		























Machine functions

	ID 679843-01		ID 679843-30		ID 679843-74		ID 679843-C6
	ID 679843-02		ID 679843-40		ID 679843-76		Black ID 679843-C7
	ID 679843-16		Green ID 679843-56		Black ID 679843-95		SPEC FCT ID 679843-D6
	ID 679843-22		Red ID 679843-57		Black ID 679843-96		ID 679843-E3
	ID 679843-23		+ ID 679843-59		Black ID 679843-A1		FCT RC ID 679843-E4
	ID 679843-24		- ID 679843-60		ID 679843-A2		ID 679843-E6
	ID 679843-25		ID 679843-61		ID 679843-A3		ID 679843-E7
	ID 679843-26		ID 679843-62		ID 679843-A4		ID 679843-E8
	ID 679843-27		FCT ID 679843-63		ID 679843-A5		
	ID 679843-28		ID 679843-64		ID 679843-A6		
	ID 679843-29		ID 679843-73		ID 679843-A9		

Spindle functions

	ID 679843-18		ID 679843-47		Red ID 679843-52		ID 679843-99
	ID 679843-19		ID 679843-48		ID 679843-65		Green ID 679843-D8
	ID 679843-20		ID 679843-49		Green ID 679843-71		ID 679843-F3
	ID 679843-21		ID 679843-50		ID 679843-72		
	ID 679843-46		ID 679843-51		Red ID 679843-89		

Other keys

	ID 679843-15		ID 679843-38		ID 679843-75		Black ID 679843-D2
	ID 679843-17		ID 679843-39		Green ID 679843-90		ID 679843-D5
	ID 679843-33		ID 679843-41		ID 679843-97		Red ID 679843-D7
	Black ID 679843-34		ID 679843-42		ID 679843-98		Black ID 679843-E2
	ID 679843-35		Red ID 679843-45		ID 679843-A7		ID 679843-E5
	ID 679843-36		ID 679843-58		ID 679843-A8		ID 679843-F2
	ID 679843-37		ID 679843-66		Black ID 679843-D1		

Control systems with UEC; MC in operating panel

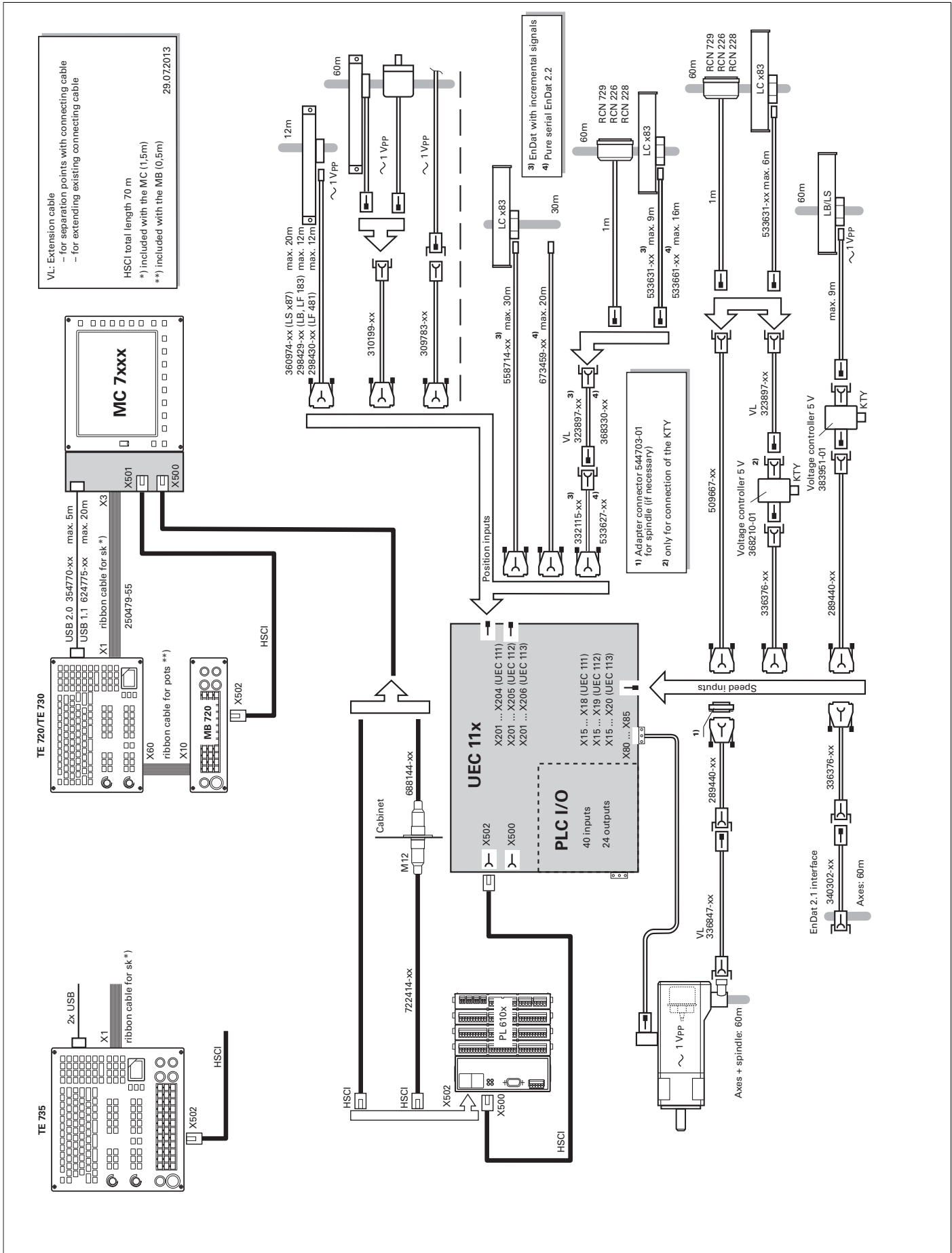

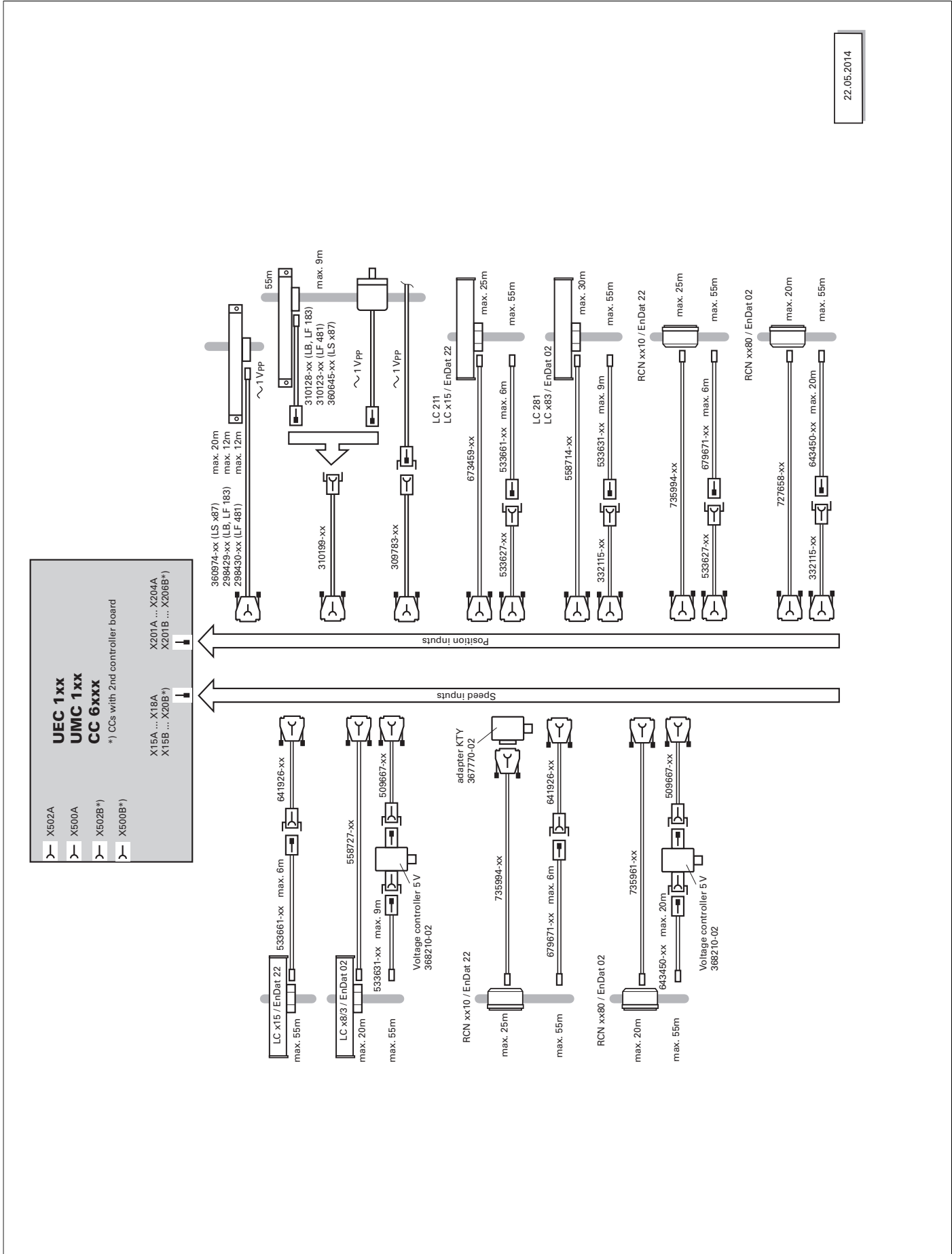

Inverter system

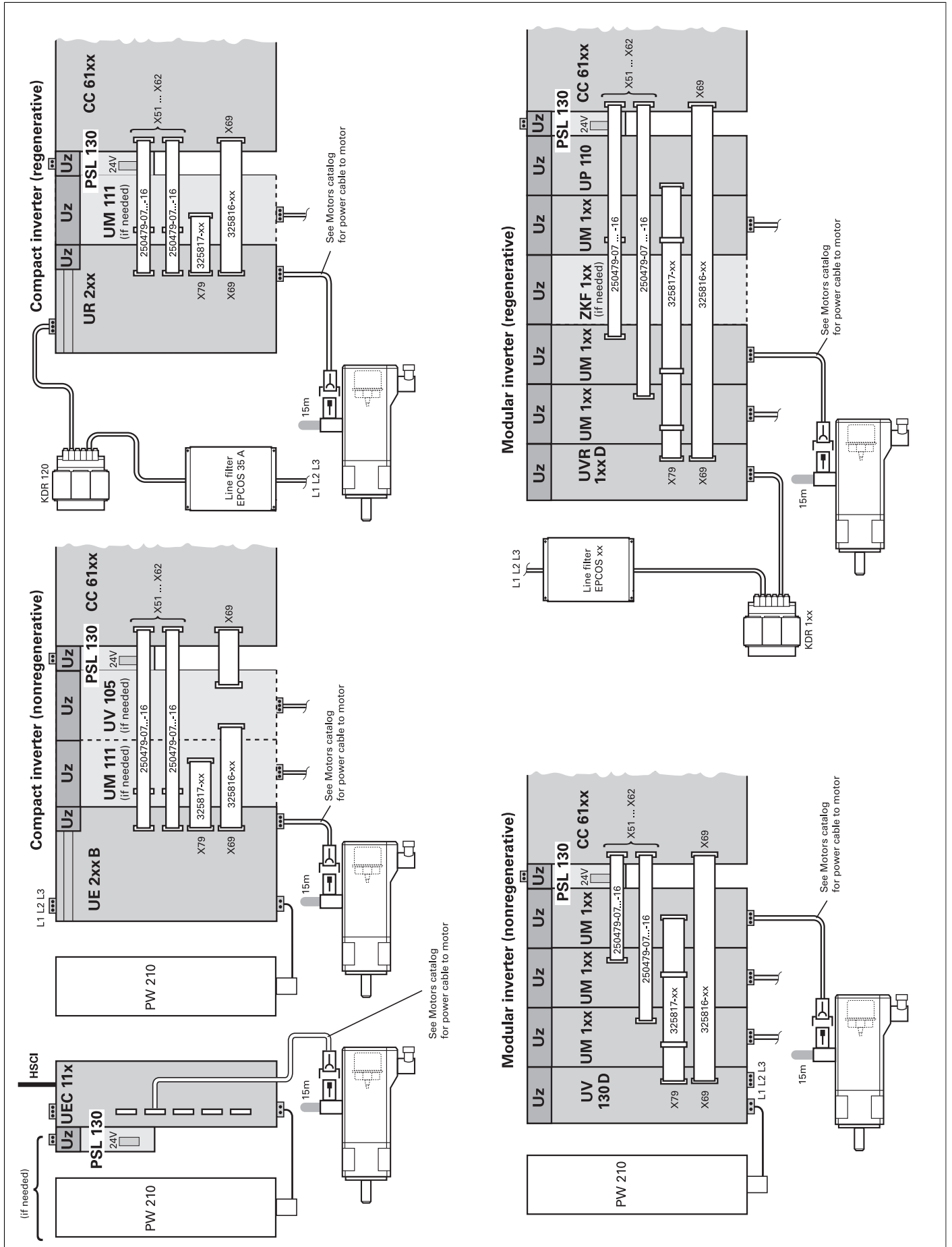

Technical description

Digital control design

Uniformly digital

In the uniformly digital control design from HEIDENHAIN, all components are connected to each other via purely digital interfaces: The control components are connected via **HSCI** (HEIDENHAIN Serial Controller Interface), the new real-time protocol from HEIDENHAIN for Fast Ethernet, and the encoders are connected via **EnDat 2.2**, the bidirectional interface from HEIDENHAIN. This achieves a high degree of availability for the entire system. It can be diagnosed and is immune to noise—from the main computer to the encoder. These outstanding properties of the uniformly digital design from HEIDENHAIN guarantee not only very high accuracy and surface quality, but rapid traverse speeds as well. Please refer to the *Uniformly Digital* Technical Information sheet for more detailed information.

HSCI

HSCI, the HEIDENHAIN Serial Controller Interface, connects the main computer, controller(s) and other control components. HSCI is based on 100BaseT Ethernet hardware. A special interface component developed by HEIDENHAIN makes short cycle times for data transfer possible.

Main advantages of the control design with HSCI:

- Hardware platform for flexible and scalable control system (e. g. local axis systems)
- High noise immunity due to digital communication between components
- Hardware basis for the implementation of “functional safety”
- Simpler wiring (initial operation, configuration)
- Inverters connected via proven PWM interface
- Large cable lengths in the entire system (HSCI up to 70 m)
- High number of possible control loops
- High number of PLC inputs/outputs
- Controller units can be installed elsewhere

CC or UEC controller units, up to nine PL 6000 PLC input/output modules, and machine operating panels (such as the MB 720 from HEIDENHAIN) can be connected to the serial HSCI bus of the MC main computer. The HR handwheel is connected directly to the machine operating panel. The combination of visual display unit and main computer is especially advantageous if the computer is housed in the operating panel. All that is required then is the power supply and an HSCI line to the controller in the electrical cabinet.

The maximum permissible number of individual HSCI participants is listed below.

HSCI components		Maximum number	
MC	HSCI master	1 in the system	
CC, UEC, UMC	HSCI slave	4 drive-control motherboards (distributed to CC, UEC, UMC as desired)	
MB, PLB 6001	HSCI slave	2 in the system	
PLB 61xx, PLB 62xx	HSCI slave	7 in the system	
HR	On MB or PLB 6001	2 in the system (of which only one HR 550 FS)	
PLD-H-xx-xx FS	In PLB 6xxx FS	10 in the system	Total maximum of 1000 inputs/outputs
PLD-H-xx-xx, PLA-H-xx-xx	In PLB 6xxx	25 in the system	

Functional safety

Basic principle

Controls from HEIDENHAIN with functional safety meet safety integrity level 2 (SIL 2) as per the EN 61 508 standard, as well as performance level d, category 3, as per EN ISO 13 849-1 (which replaced EN 954-1). These standards describe the assessment of safety-oriented systems, for example based on the failure probabilities of integrated components and subsystems. The modular approach helps manufacturers of safety-related systems to implement their systems, because they can begin with prequalified subsystems. Safety-related position encoders, the iTNC 530 control and functional safety accommodate this concept. Two redundant safety channels that work independently of each other are the foundation for controls with functional safety. All safety-relevant signals are captured, processed and output via two channels. Errors are detected by mutual comparison of the states and data in the two channels. In this way, the occurrence of just one fault in the control does not lead to the safety functions being incapacitated.

Structure

The safety-related controls from HEIDENHAIN have a dual-channel design with mutual monitoring. The SPLC (safety-related PLC program) and SKERN (safe core software) processes are the basis of the two redundant systems. The two software processes run on the MC main computer (CPU) and CC controller unit (DSP) components. The dual-channel structure of the MC and CC is also used in the PLB 6xxx FS input/output systems and the MB 7xx FS machine operating panel. This means that all safety-relevant signals (e. g. permissive buttons and keys, door contacts, emergency stop button) are captured via two channels, and are evaluated independently of each other by the MC and CC. The MC and CC use separate channels to also address the power modules, and to stop the drives in case of an error.

Components

In systems with functional safety, certain hardware components assume safety-relevant tasks. Systems with FS must consist of only those safety-relevant components, including their variants, which HEIDENHAIN has approved for use! Control components with functional safety are recognizable by the suffix FS after the model designation, e. g. MB 720 FS.

MB and TE

An MB machine operating panel with FS is indispensable for systems with functional safety. Only on such a machine operating panel do all keys have a dual-channel design. Axes can be moved without additional permissive keys.

PLB

In systems with functional safety, a combination of hardware (FS and standard) is possible, but a PLB 62xx FS is essential.

HR

FS handwheels are required in systems with functional safety because only they have the required cross-circuit-proof permissive buttons.

For a current list of components approved for FS, see the *Functional Safety FS Technical Manual*.

- Safety functions** The following safety functions are integrated in the hardware and software:
- Safe stop reactions (SS0, SS1, SS2)
 - Safe torque off (STO)
 - Safe operating stop (SOS)
 - Safely limited speed (SLS)
 - Safely limited position (SLP)
 - Safe brake control (SBC)
 - Safe operating modes
 - Operating mode 1: Automated or production mode
 - Operating mode 2: Set-up mode
 - Operating mode 3: Manual intervention
 - Operating mode 4: Advanced manual intervention, process monitoring

Please note:

The complete feature content is not yet available for all machine types with functional safety. Before planning a machine with functional safety, please inform yourself of whether the current scope of features suffices for your machine design.

- Activation of functional safety** If the control identifies a PLB 62xx FS in the system during booting, functional safety is activated.

In this case, it is essential that the following prerequisites be fulfilled:

- Functional safety versions of safety-related control components (e.g. MB 720 FS, TE 735 FS, HR 550 FS)
- Safety-related SPLC program
- Configuration of safe machine parameters
- Wiring of the machine for systems with functional safety

Functional safety cannot be activated or deactivated by parameter.

- For more information** For more information on the topic of functional safety, refer to the Technical Information documents *Safety-Related Control Technology for Machine Tools* and *Safety-Related Position Encoders*.
For details, see the *Functional Safety FS* Technical Manual. Your contact person at HEIDENHAIN will be glad to answer any questions concerning controls with functional safety.

Operating system

HEROS 5

The iTNC 530 runs HEROS 5 (HEIDENHAIN Real-time Operating System). This future-oriented operating system features powerful functions:

- Display of **PDF files**. Drawings, work instructions, etc. can be opened directly on the control.
- Direct Internet access from the iTNC 530 thanks to the **integrated browser**.
- You can open various **file formats** directly on the iTNC 530 and also edit some of them with the appropriate editors:
 - Text files (.txt, .ini)
 - Graphic files (.gif, .bmp, .jpg, .png)
 - Tables (.xls, .csv)
 - Internet files (.html)
- Standardized **display format** for operating system dialogs
- Setting up a firewall for additional **data security**

Axes

Linear axes

The iTNC 530 can control the linear axes X, Y, Z as well as U, V, W, depending on the version.

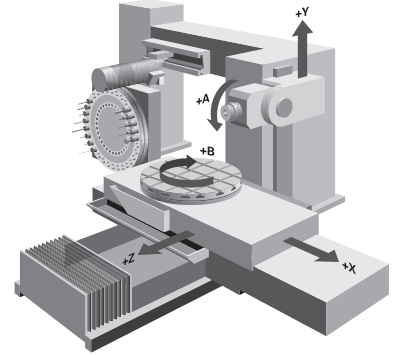

Display and programming

–99 999.9999 to +99 999.9999 [mm]

Feed rate in mm/min relative to the workpiece contour, or mm per spindle revolution

Feed rate override: 0 % to 150 %

Maximum feed rate:

$$\frac{60000 \text{ min}^{-1}}{\text{No. of motor pole pairs}} \cdot \text{Screw pitch [mm]}$$

Traverse range

–99 999.9999 to +99 999.9999 [mm]

The machine tool builder defines the traverse range. The user can set additional limits to the traverse range if he wishes to reduce the working space. Three different traverse ranges can be defined (selection by PLC).

Rotary axes

The iTNC 530 can control the rotary axes A, B and C. Special PLC functions are available for rotary axes with Hirth coupling.

Display and programming

0° to 360° or
–99 999.9999 to +99 999.9999 [°]

Feed rate in degrees per minute [°/min]

Traverse range

–99 999.9999 to +99 999.9999 [°]

The machine tool builder defines the traverse range. The user can set additional limits to the traverse range if he wishes to reduce the working space. Three different traverse ranges can be defined (selection by PLC).

Free rotation

For milling-turning operations, the rotary axis can be started via the PLC with a defined feed rate. For functions specific to milling/turning machines, see *Turning operations*.

Cylindrical surface interpolation (option 8)

A contour defined in the working plane is machined on a cylindrical surface.

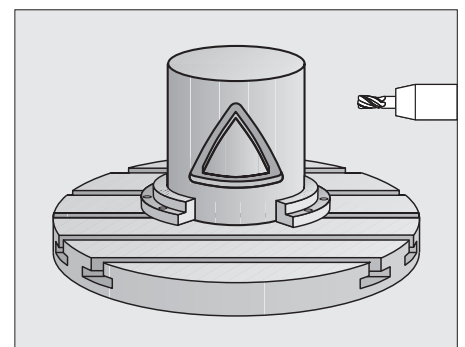

Tilting the working plane (option 8)

The iTNC 530 has special coordinate transformation cycles for controlling swivel heads and tilting tables. The offset of the tilting axes and the tool lengths are compensated by the TNC.

The TNC can manage more than one machine configuration (e. g. different swivel heads). The machine configurations are switched via the PLC. The change in the dimensions of the swivel head or tilting table caused by a rise in temperature can be compensated by the iTNC 530.

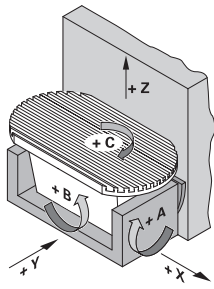

Tilting table

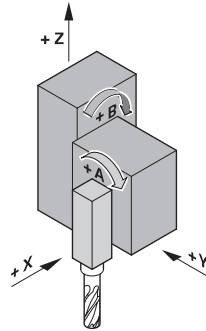

Swivel head

5-axis machining (option 9)

Tool Center Point Management (TCPM)
The offset of the tilting axes is compensated so that the tool tip remains on the contour. Handwheel commands can also be superimposed during machining without moving the tool tip from the programmed contour.

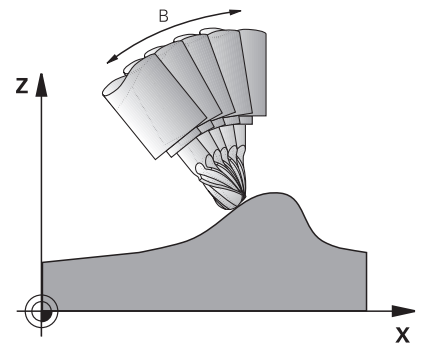

Synchronized axes (option 24)

Synchronized axes move in synchronism and are programmed with the same axis designation.

With HEIDENHAIN controls, parallel axis systems (gantry axes) such as on portal-type machines or tilting tables can be moved synchronously to each other through high-accuracy and dynamic position control.

With **gantry axes** more than one slave axis can be assigned to one master gantry axis. They may also be distributed to several controller units.

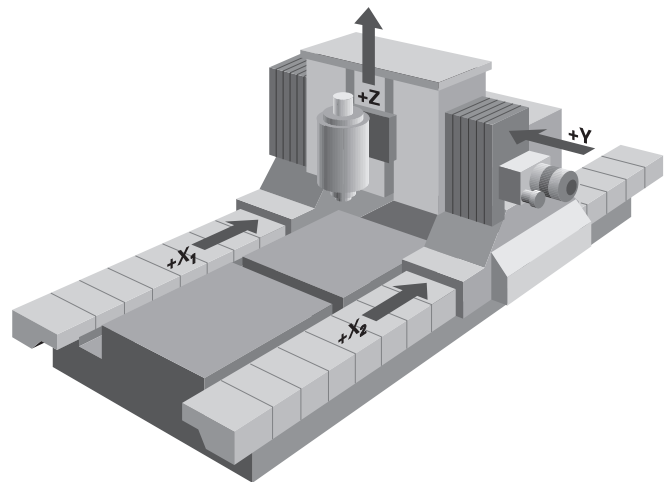

Torque control

Torque control is used on machines with mechanically coupled motors for which

- a defined distribution of drive torque is desired,
- or
- parts of the controlled system show a backlash effect that can be eliminated by tensioning the servo drives (e.g. toothed racks).

For torque control, the master and slave must be on the same motherboard (DSP). Depending on the controller unit being used, up to five slave axes can be configured for each master in this manner.

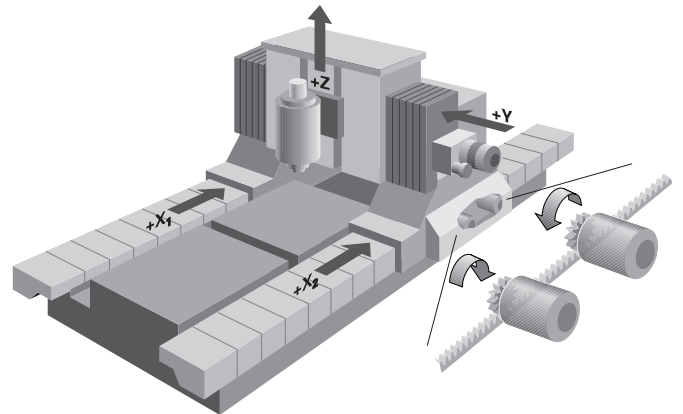

PLC axes

Axes can be controlled by the PLC. They are programmed through M functions or OEM cycles. The PLC axes are positioned independently of the NC axes and are therefore designated as asynchronous axes.

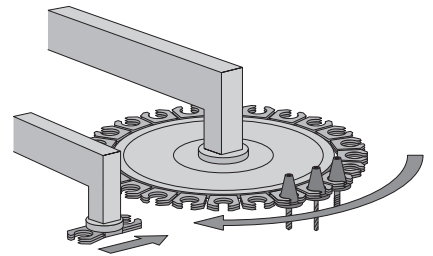

Spindle

Overview	The iTNC 530 contouring control is used in connection with the HEIDENHAIN inverter systems with field-oriented control. As an alternative, an analog nominal speed value can be output.
Controller unit	With the CC controller units and the UEC/UMC inverters, a PWM basic frequency can be set for each controller assembly (e. g. 4 kHz). Possible basic frequencies are 3.33 kHz, 4 kHz or 5 kHz. The Double Speed option (option 49) can double this frequency for high-speed spindles (e. g. 8 kHz for HF spindles). See the <i>Technical Manual</i> .
Controller groups	For example with CC 6106 1: X51 + X52 2: X53 + X54 3: X55 + X56
Maximum spindle speed	The maximum spindle speed is calculated as follows: $n_{\max} = \frac{f_{\text{PWM}} \cdot 60000 \text{ min}^{-1}}{\text{NPP} \cdot 5000 \text{ Hz}}$ f_{PWM} = PWM frequency in Hz NPP = Number of pole pairs
Operating mode switchover	For controlling the spindle (e. g. for wye/delta connection), two parameter sets can be stored. You can switch between the two parameter sets in the PLC.
Position-controlled spindle	The position of the spindle is monitored by the control.
Encoder	HEIDENHAIN rotary encoder with sinusoidal voltage signals (1 V _{pp}) or EnDat interface.
Tapping	There are special cycles for tapping with or without floating tap holder. For tapping without floating tap holder, the spindle must be operated under position control.
Oriented spindle stop	With a position-controlled spindle, the spindle can be positioned exactly to 0.1°.
Spindle override	0 to 150 %
Gear ranges	A specific nominal speed can be defined for each of the eight gear ranges. The gear code is output via the PLC.
Second spindle	Up to two spindles can be alternately controlled. You can switch from spindle 1 to spindle 2 through the PLC. Because the second spindle is controlled instead of an axis, the number of available axes is reduced by one.
Milling-head change	The iTNC 530 can manage various milling-head descriptions. You program the milling-head change in the integrated PLC.

Encoders

Overview

For speed and position control of the axes and spindle, HEIDENHAIN offers both incremental and absolute encoders.

Incremental encoders

Incremental encoders have as measuring standard a grating consisting of alternate lines and spaces. Relative movement between the scanning head and the scale causes output of sinusoidal scanning signals. The measured value is calculated from these signals.

Reference mark

When the machine is switched on, the machine axes need to traverse a reference mark for an accurate reference to be established between measured value and machine position. For encoders with distance-coded reference marks, the maximum travel until automatic reference mark evaluation for linear encoders is only 20 mm or 80 mm, depending on the model, or 10° or 20° for angle encoders.

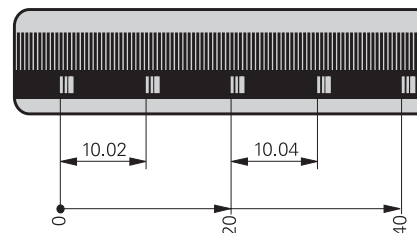

Evaluation of reference marks

The routine for traversing the reference marks can also be started for specific axes via the PLC during operation (reactivation of parked axes).

Output signals

Incremental encoders with sinusoidal output signals with $\sim 1 V_{PP}$ levels are suitable for connection to HEIDENHAIN numerical controls.

Absolute encoders

With absolute encoders, the position information is contained in several coded tracks. Thus, an absolute reference is available immediately after switch-on. Reference-mark traverse is not necessary. Additional incremental signals are output for highly dynamic control loops.

EnDat interface

The iTNC 530 features the serial EnDat 2.2 interface (includes EnDat 2.1) for the connection of absolute encoders.

Note: The EnDat interface on HEIDENHAIN encoders differs in its pin assignment from the interface on Siemens motors with integrated absolute ECN/EQN rotary encoders. Special adapter cables are available.

Encoder inputs

Incremental and absolute linear, angle or rotary encoders from HEIDENHAIN can be connected to all **position encoder** inputs of the controller unit.

Incremental and absolute rotary encoders from HEIDENHAIN can be connected to all **speed encoder** inputs of the controller unit.

Channel inputs	Signal level/ Interface ¹⁾	Input frequency ¹⁾	
		Position	Speed
Incremental signals	$\sim 1 V_{PP}$	33 kHz/350 kHz	350 kHz
Absolute position values	EnDat 2.2 ²⁾ /02	–	–
Incremental signals	$\sim 1 V_{PP}$	33 kHz/350 kHz	350 kHz
Absolute position values	EnDat 2.2 ²⁾ /22	–	–

¹⁾ Switchable

²⁾ Includes EnDat 2.1

Digital servo control

Integrated inverter Position controllers, speed controllers, current controllers and inverters are integrated in the iTNC 530. HEIDENHAIN synchronous or asynchronous motors are connected to the iTNC 530.

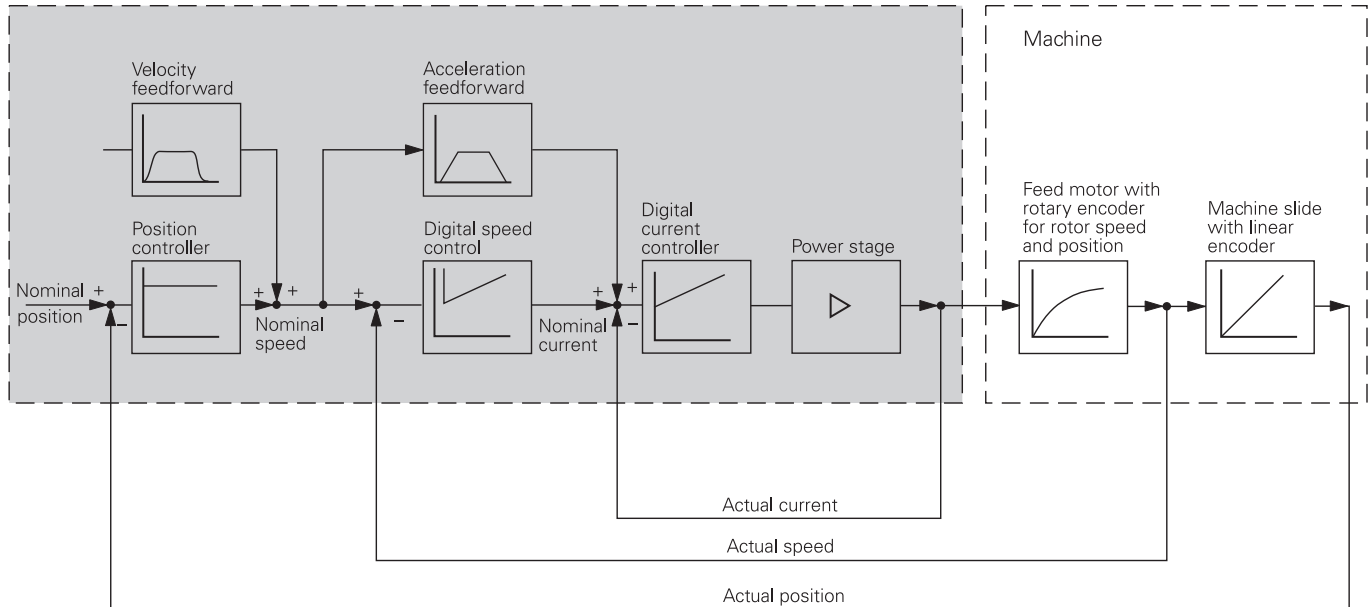

Axis feedback control The iTNC 530 can be operated with following error or feedforward control. During roughing operations at high speeds, for example, you can switch to velocity semi-feedforward control via an OEM cycle in order to machine faster at reduced accuracy.

Operation with following error The term "following error" denotes the distance between the momentary nominal position and the actual position of the axis. The velocity is calculated as follows:

$$v = k_v \cdot s_a$$

v = velocity
 k_v = position loop gain
 s_a = following error

Operation with feedforward control Feedforward means that the speed and the acceleration are adjusted to fit the machine. Together with the values calculated from the following error, it forms the nominal value. This greatly reduces the following error (to within a few μm).

Compensation of torque ripples The torque of synchronous, torque and linear motors is subject to periodic oscillations, one cause of which can be permanent magnets. The amplitude of this torque ripple depends on the motor design, and under certain circumstances can have an effect on the workpiece surface. After the axes have been commissioned with the TNCopt software, the Torque Ripple Compensation (TRC) of the CC 61xx or UEC 11x can be used to compensate it.

Control loop cycle times

The cycle time for **path interpolation** is defined as the time interval during which interpolation points on the path are calculated. The cycle time for **fine interpolation** is defined as the time interval during which interpolation points are calculated that lie within the interpolation points calculated for path interpolation. The cycle time for the **position controller** is defined as the time interval during which actual position value is compared to the calculated nominal position value. The **speed controller cycle time** is the time interval in which the actual speed value is compared to the calculated nominal speed value. The **cycle time for the current controller** is defined as the time interval during which the actual current value is compared to the calculated nominal current value.

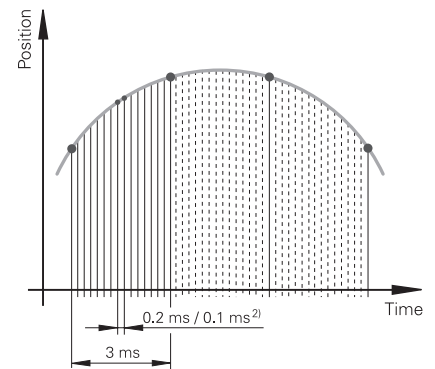

	CC/UEC/UMC
Path interpolation	3 ms
Fine interpolation	0.2 ms/0.1 ms ¹⁾
Position controller	0.2 ms/0.1 ms ²⁾
Speed controller	0.2 ms/0.1 ms ¹⁾
Current controller	0.1 ms at $f_{PVM} = 5000$ Hz

- 1) Double speed (with option 49)
- 2) Single-speed/double-speed (with option 49)

Axis clamping

The control loop can be opened through the PLC in order to clamp specific axes.

Double-speed control loops (option 49)

Double-speed control loops permit higher PWM frequencies as well as shorter cycle times of the speed controller. This makes improved current control for spindles possible, and also higher control performance for linear and torque motors.

Jerk

The derivative of acceleration is referred to as jerk. A linear change in acceleration causes a jerk step. Such motion sequences may cause the machine to oscillate.

Jerk limiting

To prevent machine oscillations, the jerk is limited to attain optimum path control.

Smoothed jerk

The jerk is smoothed by nominal position value filters. The iTNC 530 therefore mills smooth surfaces at the highest possible feed rate and yet keeps the contour accurate. The operator programs the permissible tolerance in a cycle. Special filters for HSC machining (HSC filters) can specifically suppress the natural frequencies of an individual machine. The desired accuracy and a very high surface quality are attained.

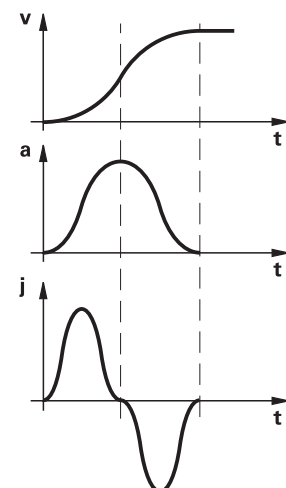

Fast contour milling

Short block processing time

The iTNC 530 provides the following important features for fast contour machining:

The block processing time of the MC 6xxx/MC 7222 is 0.5 ms. This means that the iTNC 530 is able to run long programs from the hard disk, even with contours approximated with linear segments as small as 0.2 mm, at a feed rate of up to 24 m/min.

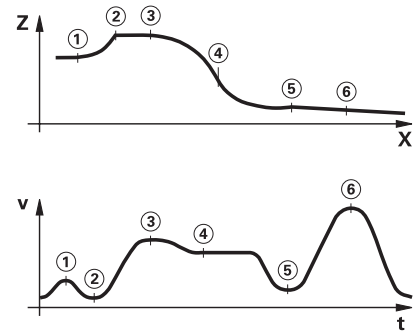

Look-ahead

The iTNC 530 calculates the geometry ahead of time in order to adjust the feed rate (max. 1024 blocks). In this way directional changes are detected in time to accelerate or decelerate the appropriate NC axes.

Spline interpolation (option 9)

If your CAD system describes contours as splines, you can transfer them directly to the iTNC 530. The iTNC 530 features a spline interpolator, with which third-degree polynomials can be processed.

Dynamic Efficiency

With the concept of Dynamic Efficiency, HEIDENHAIN offers innovative TNC functions that help the user to make heavy machining and roughing more efficient while also enhancing its process reliability. Dynamic Efficiency permits higher removal rates and therefore increases productivity without making the user resort to special tools. At the same time, it prevents any tool overloading and the concomitant premature cutter wear. Dynamic Efficiency comprises three software functions:

- **Active Chatter Control (ACC):** This option reduces chatter tendencies and permits greater infeeds
- **Adaptive Feed Control (AFC):** This option controls the feed rate depending on the machining situation
- **Trochoidal milling:** A function for the roughing of slots and pockets that eases the load on the tool

Each solution in itself offers decisive advantages in the machining process. But the combination of these TNC features, in particular, exploits the potential of the machine and tool and at the same time reduces the mechanical load.

dynamic  efficiency

Adaptive Feed Control (AFC) (option 45)

With Adaptive Feed Control (AFC), the contouring feed rate is controlled depending on the respective spindle power in percent.

Benefits of adaptive feed control:

- Optimization and reduction of machining time
- Tool monitoring
- Protection of the machine mechanics
- Documentation by capturing and saving the learning and process data
- Integrated NC function, and therefore an alternative to external software solutions
- Already existing NC programs can be used

Restrictions:

AFC cannot be used for analog spindles or in volts-per-hertz control mode.

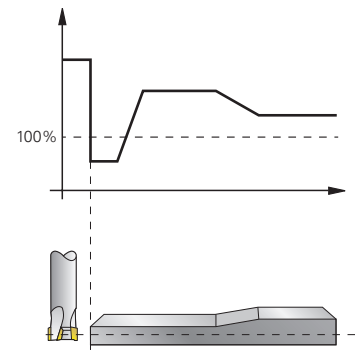

Active Chatter Control (ACC) (option 145)

Strong milling forces come into play during heavy machining—roughing at high cutting speed. Depending on the tool spindle speed, the resonances in the machine tool and the chip volume (metal-removal rate during milling), the tool can sometimes begin to “chatter.” This chattering places heavy strain on the machine, and causes ugly marks on the workpiece surface. The tool, too, is subject to heavy and irregular wear from chattering. In extreme cases it can result in tool breakage. To reduce the inclination to chattering, HEIDENHAIN now offers an effective antidote with the Active Chatter Control (ACC) option. The use of this option is particularly advantageous during heavy cutting. ACC makes substantially higher metal removal rates possible—depending on the machine model the metal removal rate increases by 25 % and more. You reduce the mechanical load on the machine and increase the life of your tools at the same time.

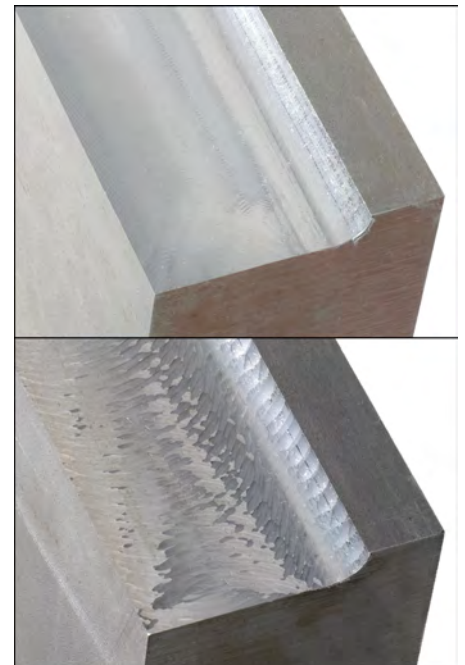

Top: Part milled with ACC
Bottom: Part milled without ACC

Monitoring functions

Description

During operation the control monitors the:

- Amplitude of the encoder signals
- Edge separation of the encoder signals
- Absolute position of encoders with distance-coded reference marks
- Current position (following error monitoring)
- Actual path traversed (movement monitoring)
- Position deviation at standstill
- Nominal speed value
- Checksum of safety-related functions
- Supply voltage
- Buffer battery voltage
- Operating temperature of the MC and CPU
- Run time of the PLC program
- Motor current and temperature
- Temperature of the power module
- DC-link voltage

With EnDat 2.2 encoders:

- the CRC checksum of the position value
- the EnDat alarm Error1→ EnDat status alarm register (0xEE)
- the EnDat alarm Error2
- the Edge speed of 5 µs
- the transmission of the absolute position value on the time grid

In the case of hazardous errors, an EMERGENCY STOP message is sent to the external electronics via the control-is-ready output, and the axes are brought to a stop. The correct connection of the iTNC 530 in the machine's EMERGENCY STOP loop is checked when the control system is switched on. In the event of an error, the control displays a message in plain language.

Dynamic Collision Monitoring (DCM) (option 40)

The TNC features a Dynamic Collision Monitoring (DCM) software option for cyclically monitoring the working space of the machine for possible collisions with machine components. The machine manufacturer must define three-dimensional collision objects within the working space of the machine that are to be monitored by the TNC during all machine motions, including those made by swivel heads and tilting tables. If two objects monitored for collision come within a defined distance of each other, the TNC outputs an error message. At the same time, the machine components concerned are shown in red color in the machine display. Dynamic collision monitoring is active in both the manual operating modes as well as the machine operating modes, and is indicated by a symbol in the operating mode display.

Please note:

- Only the machine manufacturer can define collision objects (including clamping fixtures).
- Collisions between machine components (such as swivel heads) and the workpiece cannot be detected.
- In servo-lag operation (no feedforward), an oversize must be taken into account for the collision objects.
- Checking for collision is not possible in the Test Run mode.

Collision monitoring also protects fixtures and tool carriers from collisions. These can be selected from a library, adapted and inserted in the machine's kinematics model.

The 3-D collision objects are configured with the commissioning software KinematicsDesign.

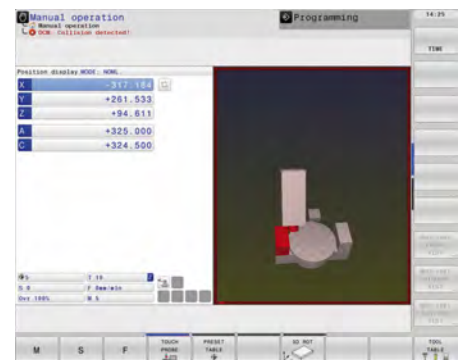

Context-sensitive help

The HELP and ERR keys provide the user with context-sensitive help. This means that in the event of an error message, the control displays information on the cause of the error and proposes solutions. The machine tool builder can also use this function for PLC error messages.

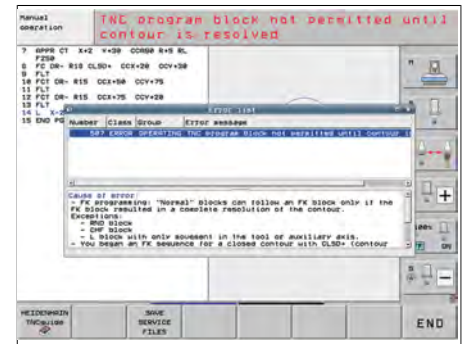

KinematicsDesign (accessory)

KinematicsDesign is a PC program for creating adaptable kinematic configurations. It supports:

- Complete kinematic configurations
- Transfer of configuration files between control and PC

When used with the iTNC 530, KinematicsDesign provides further conveniences:

- Assignment table
- Kinematics description table
- Kinematics subfile description table
- Tool-carrier kinematics description table
- Definition table for collision-monitored objects (CMO)
- Modeling of the collision-monitored objects (CMO) for DCM (option 40)

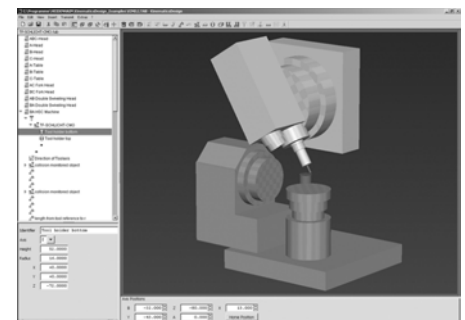

Kinematics descriptions developed for the iTNC 530 can also be converted to kinematics descriptions for the TNC 640/620/320/128.

If KinematicsDesign is connected with a control online (operation is also possible with the programming station software), then machine movements can be simulated graphically along with axis traverse. With the iTNC 530, when DCM is active the working space is also simulated and any collisions or collision-endangered components of defined objects are displayed in a definable color.

Possible display views include a wire model or a pure listing of the transformation chain. The TNC 640 and iTNC 530 can also depict the entire work envelope.

Error compensation

- Overview** The iTNC 530 automatically compensates mechanical errors on the machine.
- Linear error** Linear error can be compensated over the entire travel range for each axis.
- Nonlinear error** The iTNC 530 can compensate for ball-screw pitch errors and sag errors simultaneously. The compensation values are stored in a table.

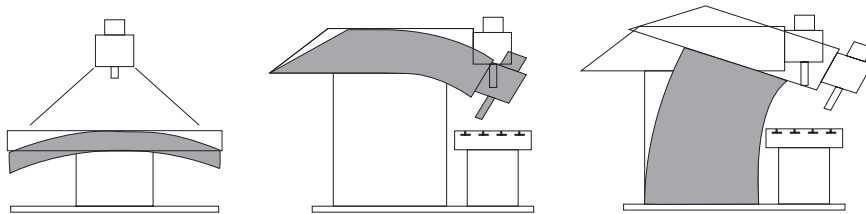

- Backlash** The play between table movement and rotary encoder movement on direction changes can be compensated in length measurements by spindle and rotary encoder. This backlash is outside the controlled system.
- Hysteresis** The hysteresis between table movement and motor movement is also compensated in direct length measurements. In this case the hysteresis is within the controlled system.
- Reversal spikes** In circular movements, reversal spikes can occur at quadrant transitions due to mechanical influences. The iTNC 530 can compensate for these reversal spikes.
- Static friction** At very low feed rates, high static friction can cause the slide to stop and start repeatedly for short periods. This is commonly known as stick-slip. The iTNC 530 can compensate for this problem condition.
- Sliding friction** Sliding friction is compensated by the speed controller of the iTNC 530.
- Thermal expansion** To compensate thermal expansion, the machine's expansion behavior must be known.

The temperature can be recorded via thermistors connected to the analog inputs of the iTNC 530. The PLC evaluates the temperature information and transfers the compensation value to the NC.

KinematicsOpt (option 48)

Using the KinematicsOpt function, machine tool builders or end users can check the accuracy of rotary or swivel axes, and compensate for possible displacements of the center of rotation of these axes. The deviations are automatically transferred to the kinematics description and can be taken into account in the kinematics calculation.

In order to measure the rotary axes, you must attach a calibration sphere (e.g. KKH 100 or KKH 250 from HEIDENHAIN) at any position on the machine table. A HEIDENHAIN touch probe uses a special cycle to probe this calibration sphere, and measures the rotary axes of the machine fully automatically. But first you define the resolution of the measurement and define for each rotary axis the range that you want to measure. The results of measurement are the same regardless of whether the axis is a rotary table, a tilting table or a swivel head.

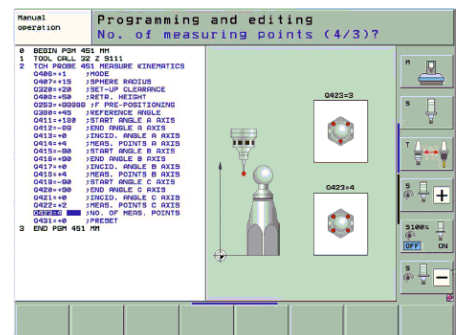

**Calibration sphere
(accessory)**

HEIDENHAIN offers calibration spheres as accessories for the measurement of rotary axes with KinematicsOpt:

KKH 100	Height: 100 mm	ID 655475-02
KKH 250	Height: 250 mm	ID 655475-01



**KinematicsComp
(option 52)**

Narrow workpiece tolerances require high machine accuracy. However, machine tools inevitably have errors resulting from their assembly or the design.

The more axes a machine has, the more sources of errors there are. For example, according to ISO 230-1, a linear axis can have six types of error, and a rotary axis can have eleven. The use of mechanical means to cope with these errors requires considerable effort. These errors become particularly evident on 5-axis machines or very large machines. Thermal expansion that can cause highly complex geometry changes of machine components cannot be disregarded either.

The KinematicsComp function (option 52) enables the machine tool builder to improve machine accuracy considerably.

The machine's degrees of freedom and the positions of the centers of rotation of the rotary axes are described in the standard kinematics of the iTNC 530. The expanded kinematics description of KinematicsComp permits the import of compensation-value tables. Most of the geometry errors of a machine can be described in compensation-value tables. They are compensated in such a way that the tool center point (TCP) follows exactly the ideal nominal contour. Thermally induced errors are also measured and compensated via sensors and the PLC.

For example, the spatial errors of the tool tip are measured with a laser tracer or laser interferometer.

The KinematicsComp option cannot be enabled for the export versions.



Fault characteristics according to ISO 230-1: EBA

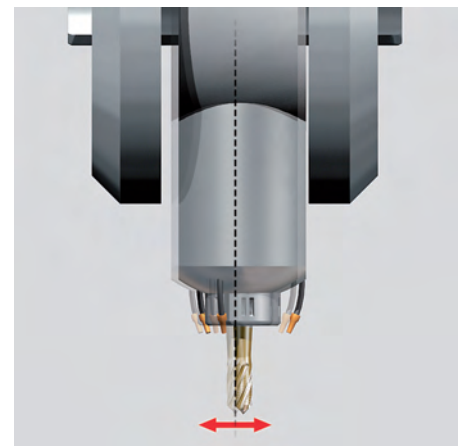

Fault characteristics according to ISO 230-1: EXA

Dynamic Precision

The hypernym Dynamic Precision stands for a number of HEIDENHAIN solutions for milling that dramatically improve the dynamic accuracy of a machine tool. The dynamic accuracy of machine tools can be seen in position errors at the tool center point (TCP), which depend on motion quantities such as velocity and acceleration (also jerk) and result from vibrations of machine components and other causes. All the deviations are together responsible for dimensional errors and faults in the workpiece surface. They therefore have a decisive influence on quality and, when poor-quality parts are scrapped, also on productivity.

Because the stiffness of machine tools is limited for reasons of design and economy, problems such as compliance and vibration within the machine design are very difficult to avoid. Dynamic Precision counteracts these problems with intelligent control technology to enable designers to further improve the quality and dynamic performance of machine tools. That saves time and money in production.

The machine tool builder can use the options comprised by Dynamic Precision either individually or in combination:

- **CTC** – Compensates acceleration-dependent position errors at the tool center point, thereby increasing accuracy in acceleration phases
- **AVD** – Active vibration damping improves surfaces
- **PAC** – Position-dependent adaptation of control parameters
- **LAC** – Load-dependent adaptation of control parameters enhances accuracy regardless of load and aging
- **MAC** – Motion-dependent adaptation of control parameters

Cross Talk Compensation (CTC) (option 141)

CTC (option 141) makes it possible to compensate dynamic position deviations that can occur with the use of coupled axes.

To increase productivity, machine tool users are asking for ever higher feed rates and acceleration values, while at the same time they need to maintain the highest possible surface quality and accuracy, placing very special requirements on path control.

Highly dynamic acceleration processes introduce forces to the structure of a machine tool. They can deform parts of the machine and thereby lead to deviations at the tool center point (TCP). Besides deformation in axis direction, the dynamic acceleration of an axis due to mechanical axis coupling can also result in deformation of axes that are perpendicular to the direction of acceleration. The resulting position error at the TCP in the direction of the accelerated axis and lateral axes is proportional to the amount of acceleration.

If the dynamic position error as a function of the axis acceleration is known, this acceleration-dependent error can be compensated with the CTC option (Cross Talk Compensation) in order to prevent negative effects on the surface quality and accuracy of the workpiece. Often, the resulting error at the TCP depends not only on the acceleration but also on the position of the axes in the working space. This can also be compensated by CTC.

dynamic + precision

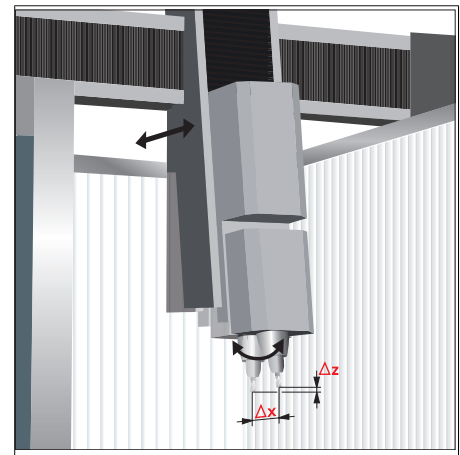

Active Vibration Damping (AVD) (option 146)

The high dynamics of modern machine tools lead to deformations in the machine base, frame and drive train during acceleration and deceleration of the feed drives. This results in vibrations, such as machine setup vibrations, that may reduce the attainable accuracy and surface quality of the workpieces. The Active Vibration Damping (AVD) controller function dampens the especially critical low-frequency oscillations and optimizes the control behavior of the affected axis at the same time so that high-accuracy workpieces with increased surface quality can also be produced at high feed rates. The improved rigidity attained can be used to increase the dynamic limit values (e. g. jerk), and therefore makes reduced machining times possible.

Position Adaptive Control (PAC) (option 142)

Option 142, PAC, permits dynamic and position-dependent adaptation of controller parameters depending on the position of the tool in space.

The specifics of a machine's kinematics cause a unique position of the axes' center of gravity in the working space. This results in a variable dynamic behavior of the machine, which can negatively influence the control's stability depending on the axis positions.

To exploit the machine's dynamic possibilities, you can use the PAC option (Position Adaptive Control) to change machine parameters depending on position. This makes it possible to assign respectively optimal loop gain to defined support points. Additional position-dependent filter parameters can be defined in order to further increase control loop stability.

Load Adaptive Control (LAC) (option 143)

LAC (option 143) enables you to adapt controller parameters dynamically depending on the load or friction.

The dynamic behavior of machines with rotary tables can vary depending on the mass moment of inertia of the fixed workpiece. The LAC option (Load Adaptive Control) enables the control to automatically ascertain the workpiece's current mass moment of inertia and the friction forces.

In order to optimize changed control behavior at differing loads, adaptive feedforward controls can exploit data on acceleration, holding torque, static friction and friction at high shaft speeds.

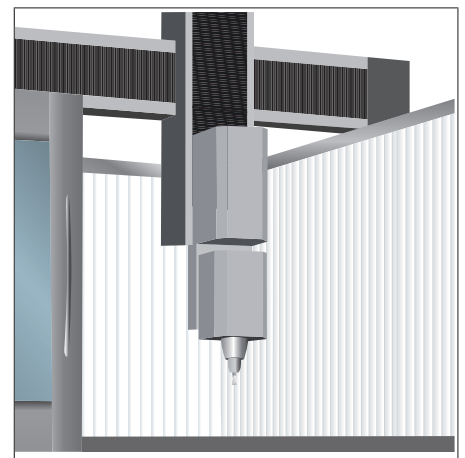

Motion Adaptive Control (MAC) (option 144)

In addition to the position-dependent adjustment of machine parameters by the PAC option, the MAC option (Motion Adaptive Control) also provides a way to change machine parameter values depending on other input quantities such as velocity, following error or acceleration of a drive. Through this motion-dependent adaptation of the control parameters it is possible, for example, to realize a velocity-dependent adaptation of the k_v factor on motors whose stability changes through the various traversing velocities.

Crossover Position Filter (CPF)

To increase the stability of the position control loop in systems with resonances, the position signal from the position encoder, which is filtered through a low-pass filter, is combined with the position signal from the motor speed encoder, which is filtered through a high-pass filter. This signal combination is made available to the position controller as actual position value. The possible position controller gain (k_v factor) is increased significantly by this. The filter separation frequency is set specifically for each axis via machine parameters. The CPF can be used only in dual-encoder systems, i.e. on drive motors with speed encoder and position encoder.

Commissioning and diagnostic aids

Overview

The iTNC 530 provides comprehensive internal commissioning and diagnostic aids. It also includes highly effective PC software for diagnosis, optimization and remote control.

Diagnostic function

The integral diagnostic function permits:

- Display and evaluation of internal control statuses
- Display and evaluation of status signals of the inverter components



Electronic ID label

Various HEIDENHAIN components feature an electronic ID label to simplify commissioning and diagnostics. The information, such as model designation, ID number or serial number, stored in this ID label can be read by the iTNC 530, or the DriveDiag or TNCopt software for PCs.

The diagnostic function of the iTNC 530 is especially user friendly. It automatically recognizes the motor type and, if required, updates the machine parameter entry every time it is switched on.

DriveDiag

DriveDiag permits quick and easy troubleshooting of the drives. The following diagnostic functions are available:

- Reading and displaying the electronic ID labels of QSY motors with EQN 13xx or ECN 13xx as well as the inverter modules UVR 1xxD and UM 1xxD
- Displaying and evaluating the internal control conditions and the status signals of the inverter components
- Displaying the analog values available to the drive controller
- Automatic test for proper function of motors and inverters, of position encoders and speed encoders

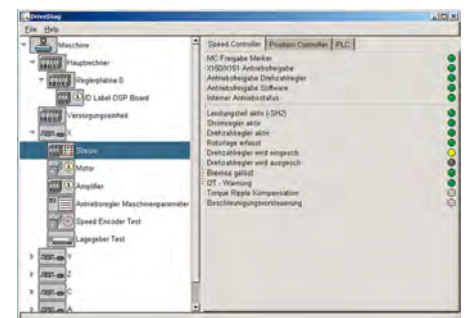

DriveDiag can be called directly from the control via the Diagnosis soft key. It is also available for downloading as PC software (accessory) from HESIS Web Including FileBase on the Internet. End users have read-access, whereas the code number for the machine tool builder gives access to comprehensive testing possibilities with DriveDiag.

TNCopt (accessory)

PC software for commissioning digital control loops
Functions:

- Commissioning the current controller
- (Automatic) commissioning of the speed controller
- (Automatic) optimization of sliding-friction compensation
- (Automatic) optimization of the reversal-spike compensation
- (Automatic) optimization of k_v factor
- Circular interpolation test, contour test

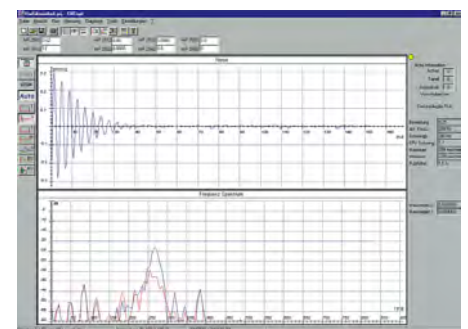

Requirements:

DriveDiag and TNCopt place the following demands on the PC:

- Windows 2000 / XP / Vista / 7 operating system
- At least 15 MB free memory on the hard disk
- Serial or Ethernet interface

Oscilloscope

The iTNC 530 features an integrated oscilloscope. Both X/t and X/Y graphs are possible. The following characteristic curves can be recorded and stored in six channels:

- Actual value and nominal value of the axis feed rate
- Contouring feed rate
- Nominal and actual position
- Following error of the position controller
- Nominal and actual values for speed, acceleration and jerk
- Content of PLC operands
- Encoder signal (0° – A) and (90° – B)
- Difference between position and speed encoder
- Nominal velocity value
- Integral-action component of the nominal current value
- Torque-determining nominal current value

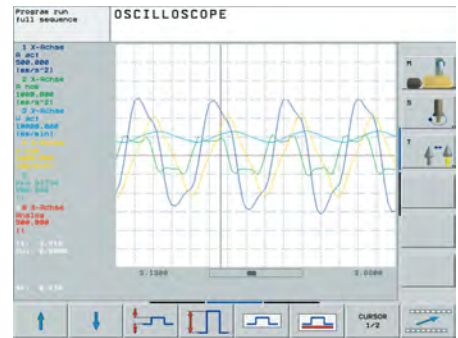

Logic signals

Simultaneous graphic representation of the logic states of up to 16 operands (markers, words, inputs, outputs, counters, timers)

- Marker (M)
- Input (I)
- Output (O)
- Timers (T)
- Counter (C)
- IpoLogik (X)

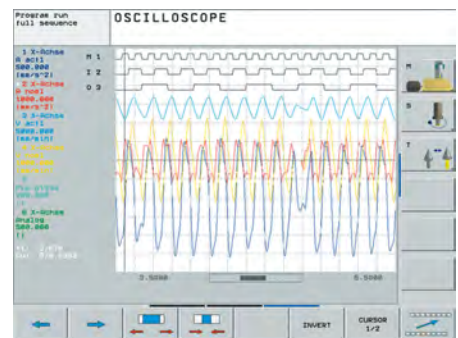

TNCscope (accessory)

PC software for transferring the oscilloscope files to a PC. With TNCscope you can record and save up to 16 channels simultaneously.

Logic diagram

Simultaneous graphic representation of the logic states of up to 16 operands (markers, words, inputs, outputs, counters, timers)

Table function

The current conditions of the markers, words, inputs, outputs, counters and timers are displayed in tables. The conditions can be changed through the keyboard.

Trace function

The current content of the operands and the accumulators is shown in the statement list in each line in hexadecimal or decimal code. The active lines of the statement list are marked.

Log

For the purposes of error diagnostics, all error messages and keystrokes are recorded in a log. The entries can be read using the **PLCdesign** or **TNCremo** software for PCs.

TeleService (accessory)

PC software for remote diagnostics, remote monitoring and remote operation of the control. For more information, please ask for the *Remote Diagnosis with TeleService* Technical Information sheet.

Bus diagnosis

In Diagnosis mode, the structure of the HSCI/PROFIBUS system as well as the details of the HSCI/PROFIBUS components can be displayed in a clearly laid out screen. For HSCI components this is possible even to the level of individual terminals.

Integrated PLC

Overview

The PLC program is created by the machine manufacturer either at the control or with the PLC development software **PLCdesign** (accessory). Machine-specific functions are activated and monitored via the PLC inputs/outputs. The number of PLC inputs/outputs required depends on the complexity of the machine.

PLC inputs/outputs

PLC inputs and outputs are available via the external PL 6000 PLC input/output systems or the UEC 11x. The PLC inputs/outputs and the PROFIBUS-DP-capable I/O system must be configured with the IOconfig PC software.

PLC programming

Format	Statement list
Memory	1 GB
Cycle time	9 ms to 30 ms (adjustable)
Command set	<ul style="list-style-type: none">• Bit, byte and word commands• Logical operations• Arithmetic commands• Comparisons• Nested calculations (parentheses)• Jump commands• Subprograms• Stack operations• Submit programs• 952 timers• 48 counters• Comments• PLC modules• 100 strings

Encryption of PLC data

Encrypting the PLC partition (PLCE:) is an effective tool for the machine tool builder to prevent third parties from viewing or changing files. The files on the PLCE partition can only be read by the TNC or by using the correct OEM keyword.

This ensures that OEM-specific know-how and special custom-designed solutions cannot be copied or changed.

The machine tool builder can also determine the size of the encrypted partition. The size is defined by the machine tool builder when the PLCE partition is created. Another advantage is that the data can be backed up from the control to a separate data carrier (USB drive, network e.g. via TNCremo) in spite of the encryption, and can later be uploaded again. You need not enter the password, but the data cannot be read until the keyword is supplied.

PLC window

PLC error messages can be displayed by the TNC in the dialog line during operation.

Small PLC window

The TNC can show additional PLC messages and bar diagrams in the small PLC window.

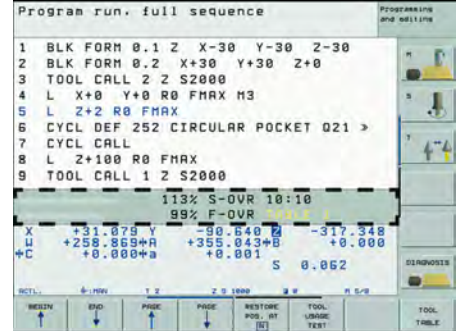

Small PLC window

Large PLC window

A complete PLC page can be shown as a window. PLC messages and graphics can be displayed.

PLC soft keys

With the BF 750, the machine tool builder can define his own soft keys on the screen, instead of the horizontal NC soft keys. In addition, he can define his own PLC soft keys in the vertical soft-key row.

The BF 760 also features soft keys on the left of the screen. Self-defined soft keys can be shown there as required.

PLC positioning

All closed-loop axes can be also positioned via the PLC. PLC positioning of the NC axes cannot be superimposed on NC positioning.

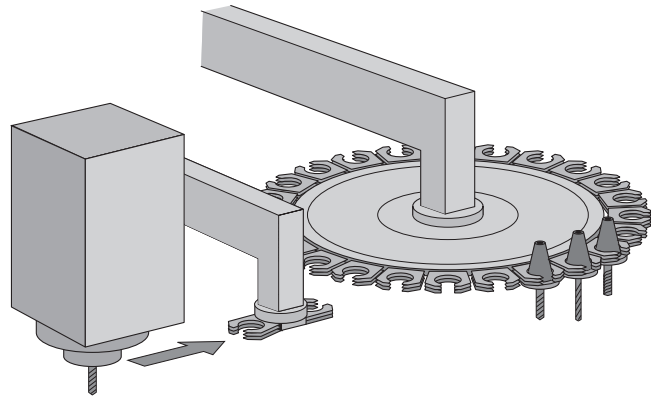

PLC axes

Axes can be controlled by the PLC. They are programmed by M functions or OEM cycles. The PLC axes are positioned independently of the NC axes.

PLCdesign (accessory)

PC software for PLC program development.
The PC program **PLCdesign** can be used for easy creation of PLC programs. Comprehensive examples of PLC programs are included.

Functions:

- Easy-to-use text editor
- Menu-guided operation
- Programming of symbolic operands
- Modular programming method
- "Compiling" and "linking" of PLC source files
- Operand commenting, creation of the documentation file
- Comprehensive help system
- Data transfer between the PC and control
- Creation of PLC soft keys

PC requirements:

- Windows 2000 / XP / Vista / 7 / 8 operating system
- At least 20 MB free memory on the hard disk
- Serial interface; Ethernet interface recommended
- Internet Explorer

Python OEM Process (option 46)

The Python OEM Process option is an effective tool for the machine tool builder to use an object-oriented high-level programming language in the control (PLC). Python is an easy-to-learn script language that supports the use of all necessary high-level language elements.

Python OEM Process can be universally used for machine functions and complex calculations, as well as to display special user interfaces. User-specific or machine-specific solutions can be efficiently implemented. Numerous libraries on the basis of Python and GTK are available, regardless of whether you want to create special algorithms for special functions, or separate solutions such as an interface for machine maintenance software.

The applications created can be included via the PLC in the familiar PLC windows, or they can be displayed in separate free windows that can be expanded to the control's full screen size.



PLC basic program

The PLC basic program serves as a basis for adapting the control to the requirements of the respective machine. It can be downloaded from the Internet.

These essential functions are covered by the PLC basic program:

- Controlling all axes
- Clamped axes
- Homing the axes; reference end positions
- Positioning the axes after reference run
- Compensating the axis temperature
- Switching the traverse ranges
- Alternating table operation
- Feed rate control
- Spindle control and orientation
- Activating tool-specific torque monitoring
- Tool changer
- Pallet changer (translational, rotatory, setup functions)
- Vertical PLC soft-key row
- Support for 19" screens
- Displaying and managing PLC error messages
- Status display in the small PLC window
- Hydraulic control
- Control of the coolant system (internal, external, air)
- M functions
- Lubrication
- Chip conveyor
- Operation of the second spindle alternately with the first
- Wye/delta connection switchover (static, dynamic)
- S-coded spindle
- 3-D head with C-axis operation
- 3-D head change
- Positioning the spindle as an axis
- Operation with clamped axes
- Axes with central drive
- Axes with Hirth grid
- Indexing fixture
- PLC log
- Touch probes
- PLC support for handwheels
- Control of doors
- Support for IPC 61xx

Interfacing to the machine

OEM cycles The machine tool builder can create and store his own cycles for recurring machining tasks. These OEM cycles are used in the same way as standard HEIDENHAIN cycles.

CycleDesign (accessory) The soft-key structure for the cycles is managed using the **CycleDesign** PC program. In addition, CycleDesign can be used to store help graphics and soft keys in BMP format in the TNC.

OEM options (options 101 to 130) The machine tool builder can enable his own developments by using the HEIDENHAIN option management in the SIK menu of the control. Thirty OEM options are available that can be enabled separately with a HEIDENHAIN keyword just as any normal option. These options are requested, for example, by OEM cycles or PLC modules that are ideally stored on the encrypted PLCE partition of the control. Another advantage is that options can be enabled with the Software Key Generator for a limited time for testing.

Tool management With integral PLC, the tool changer is moved either via proximity switch or as a controlled axis. Tool management including tool life monitoring and replacement tool monitoring is carried out by the iTNC 530.

Tool measurement Tools can be measured and checked using the **TT** or **TL** tool touch probes (accessory). The control features standard cycles for automatic tool measurement. The control calculates the probing feed rate and the optimal spindle speed. The measured data is stored in a tool table.



Cutting data calculation The user selects the material and the tool he wishes to use. The optimal values for feed rate and spindle speed are then calculated by the iTNC 530. All of this data is stored in cutting data tables and can be adapted by the user as he wishes.

Pallet management Pallet movement can be controlled via PLC axes. The order of movement, as well as pallet and workpiece datums, must be defined in the pallet table by the user. The pallet tables are freely configurable, which means that any information can be stored in the tables and called up later via the PLC. The execution of pallet tables can be workpiece-oriented or tool-oriented.

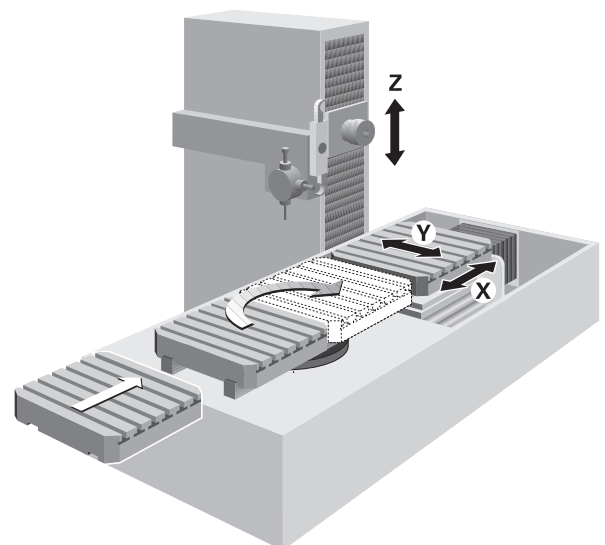

Data transfer and communication

Data interfaces

Overview	The iTNC 530 is connected to PCs, networks and other data storage devices via data interfaces.	
Ethernet	The iTNC 530 can be interconnected via the Ethernet interface. The control features a 1000BaseT (Twisted Pair Ethernet) connection to the data network. Maximum transmission distance: Unshielded 100 m Shielded 400 m	
Protocol	The iTNC 530 communicates using the TCP/IP protocol.	
Network connection	<ul style="list-style-type: none">• NFS file server• Windows networks (SMB)	
Data transfer rate	Approx. 400 to 800 Mbps (depending on file type and network utilization)	
RS-232-C	Data interface according to DIN 66 020 or EIA standard RS-232-C. Maximum transmission distance: 20 m	
Data transfer rate	115 200; 57 600; 38 400; 19 200; 9600; 4800; 2400; 1200; 600; 300; 150; 110 bps	
Protocols	The iTNC 530 can transfer data using various protocols.	
Standard data transfer	The data is transferred character by character. The number of data bits, stop bits, the handshake and character parity must be set by the user.	
Blockwise data transfer	The data is transferred blockwise. A block check character (BCC) is used to ensure data integrity. This method improves data security.	
LSV2	Bidirectional transfer of commands and data according to DIN 66 019. The data is divided into blocks and transferred.	
Adapter block	For connecting the interface to the electrical cabinet or operating panel. RS-232-C adapter	
	9-pin	ID 363987-02
	25-pin	ID 310085-01
USB	The iTNC 530 features USB ports for the connection of standard USB devices, such as the mouse, drives, etc. There are four USB 3.0 ports on the rear of the MC 7xxx. The MC 6xxx has four USB 3.0 ports. One of them is led to the BF or TE. More USB 2.0 ports are in the integrated USB hub on the rear of the BF. One easily accessible USB 2.0 port is on the front of the unit. A cover cap protects it from contamination. The USB ports are rated for a maximum of 0.5 A.	
USB cables	Cable length up to 5 m	ID 354770-xx
	Cable length 6 m to 30 m with integrated amplifier; USB 1.1.	ID 624775-xx

USB hub

If you need further USB ports or if the supply current is not sufficient, a USB hub is required. The USB hub from HEIDENHAIN offers four free USB 2.0 ports.

USB hub ID 582884-02
24 V DC power supply / max. 300 mA

**Cover**

The USB hub can be installed in the operating panel in such a way that two USB ports can be accessed from the outside. An optionally available cover cap can be used to protect the ports from contamination.

Cover ID 508921-01

Software for data transfer

We recommend using HEIDENHAIN software to transfer files between the iTNC 530 and a PC.

TNCremo (accessory)

This PC software package helps the user to transfer data from the PC to the control. The software transfers data blockwise with block check characters (BCC).

Functions:

- Data transfer (also blockwise)
- Remote control (only serial)
- File management and data backup of the control
- Reading out the log
- Print-out of screen contents
- Text editor
- Managing more than one machine

Requirements:

- Windows 2000 / XP / Vista / 7 / 8 operating system
- At least 10 MB free hard-disk space
- Serial or Ethernet interface

TNCremoPlus (accessory)

In addition to the features you are already familiar with from TNCremo, TNCremoPlus can also transfer the current content of the control's screen to the PC (live screen). This makes it very simple to monitor the machine.

TNCremoPlus ID 340447-xx

Remote Desktop Manager (option 133)

Remote operation and display of external computer units via Ethernet connection (e.g. to a Windows PC). The information is displayed on the control's screen.

Remote desktop manager ID 894423-01

DNC applications

Overview

The development environments on Windows operating systems are particularly well suited as flexible platforms for application development in order to come to terms with the increasingly complex requirements of the machine's environment. The flexibility of the PC software and the large selection of ready-to-use software components and standard tools in the development environment enable you to develop PC applications of great use to your customers in a very short time, for example:

- Error reporting systems that, for example, send the customer a text message to his cell phone reporting problems on the currently running machining process
- Standard or customer-specific PC software that decidedly increases process security and equipment availability
- Software solutions controlling the processes of manufacturing systems
- Information exchange with job management software

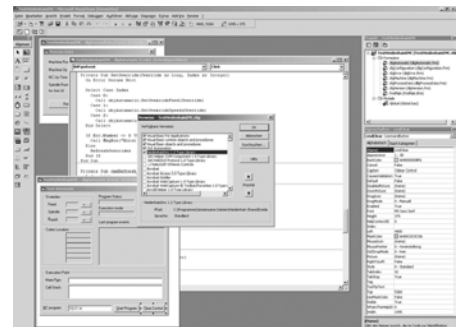

HEIDENHAIN DNC (option 18)

The HEIDENHAIN DNC software interface is an attractive communication platform for this purpose. It provides all the data and configuration capabilities needed for these processes so that an external PC application can evaluate data from the control and, if required, influence the manufacturing process.

RemoTools SDK (accessory)

To enable you to use HEIDENHAIN DNC effectively, HEIDENHAIN offers the RemoTools SDK development package. It contains the COM components and the ActiveX control for integration of the DNC functions in development environments.

RemoTools SDK ID 340442-xx

For more information, refer to the *HEIDENHAIN DNC* brochure.

virtualTNC (accessory)

The **virtualTNC** control software is a control component for virtual machines for machine simulations, and is available via the HEIDENHAIN DNC interface.

Single station license ID 584421-01

Network license For 14 workstations ID 643492-01
For 20 workstations ID 643494-01

For more information, refer to the *HEIDENHAIN DNC* brochure.

Mounting information

Clearances and mounting

Proper minimum clearance

When mounting the control components, please observe proper minimum clearances, space requirements, length and position of the connecting cables.

Installation in an electrical cabinet

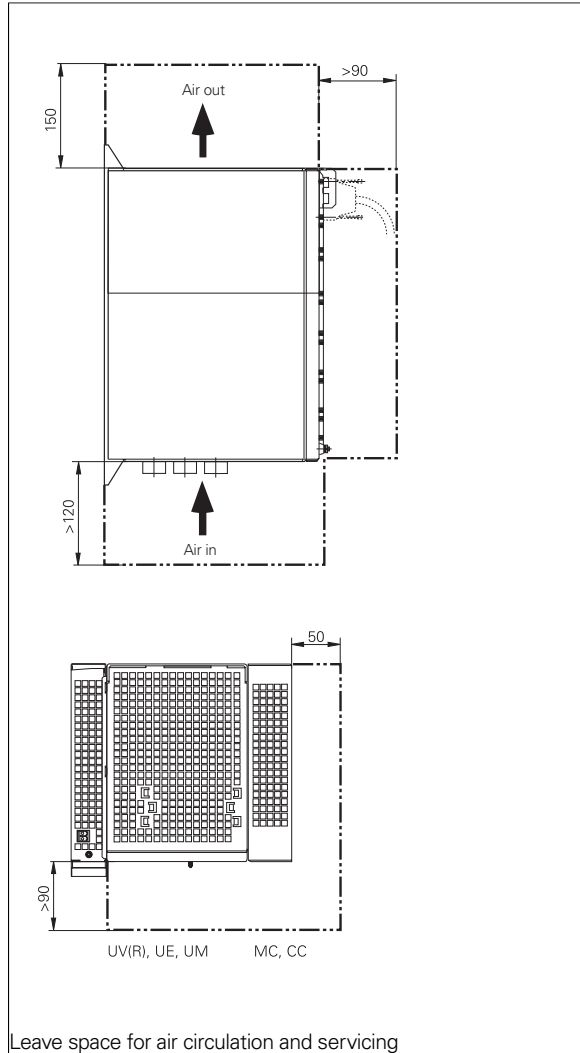

Installation in an operating panel

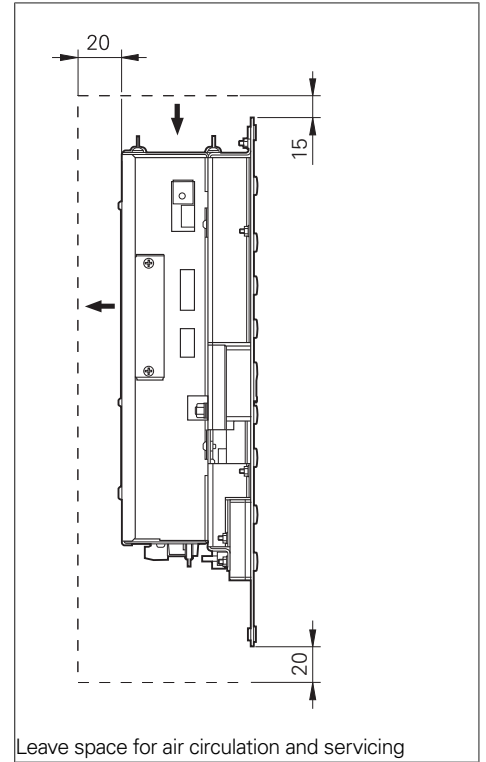

Mounting and electrical installation

Keep the following in mind during mounting and electrical installation:

- National regulations for power installations
- Interference and noise immunity
- Operating conditions
- Mounting position

Degrees of protection

The following components fulfill the requirements for IP 54 (dust protection and splash-proof protection):

- Visual display unit (when properly installed)
- Keyboard unit (when properly installed)
- Machine operating panel (when properly installed)
- Handwheel

All electric and electronic control components must be installed in an environment (e. g. electrical cabinet, housing) that fulfills the requirements of protection class IP 54 (dust and splash-proof protection) in order to fulfill the requirements of contamination level 2. All components of the OEM operating panel must also comply with protection class IP 54, just like the HEIDENHAIN operating panel components.

Electromagnetic compatibility

Protect your equipment from interference by observing the rules and recommendations specified in the Technical Manual.

Intended place of operation

This unit fulfills the requirements for EN 50370-1 and is intended for operation in industrially zoned areas.

Likely sources of interference

Interference is produced by capacitive and inductive coupling into electrical conductors or into device connections, caused by e. g.:

- Strong magnetic fields from transformers or electric motors
- Relays, contactors and solenoid valves
- High-frequency equipment, pulse equipment and stray magnetic fields from switch-mode power supplies
- Power lines and leads to the above equipment

Protective measures

- Keep a minimum distance of 20 cm from the MC, CC and its leads to devices that carry interference signals
- Keep a minimum distance of 10 cm from the MC, CC and its leads to cables that carry interference signals. For cables in metallic ducting, adequate decoupling can be achieved by using a grounded separation shield.
- Shielding according to EN 50 178
- Use equipotential bonding conductors with a cross section of 6 mm²
- Use only genuine HEIDENHAIN cables and connecting elements

Overall dimensions

Main computer

MC 6441, MC 6541, MC 6641, IPC 6641

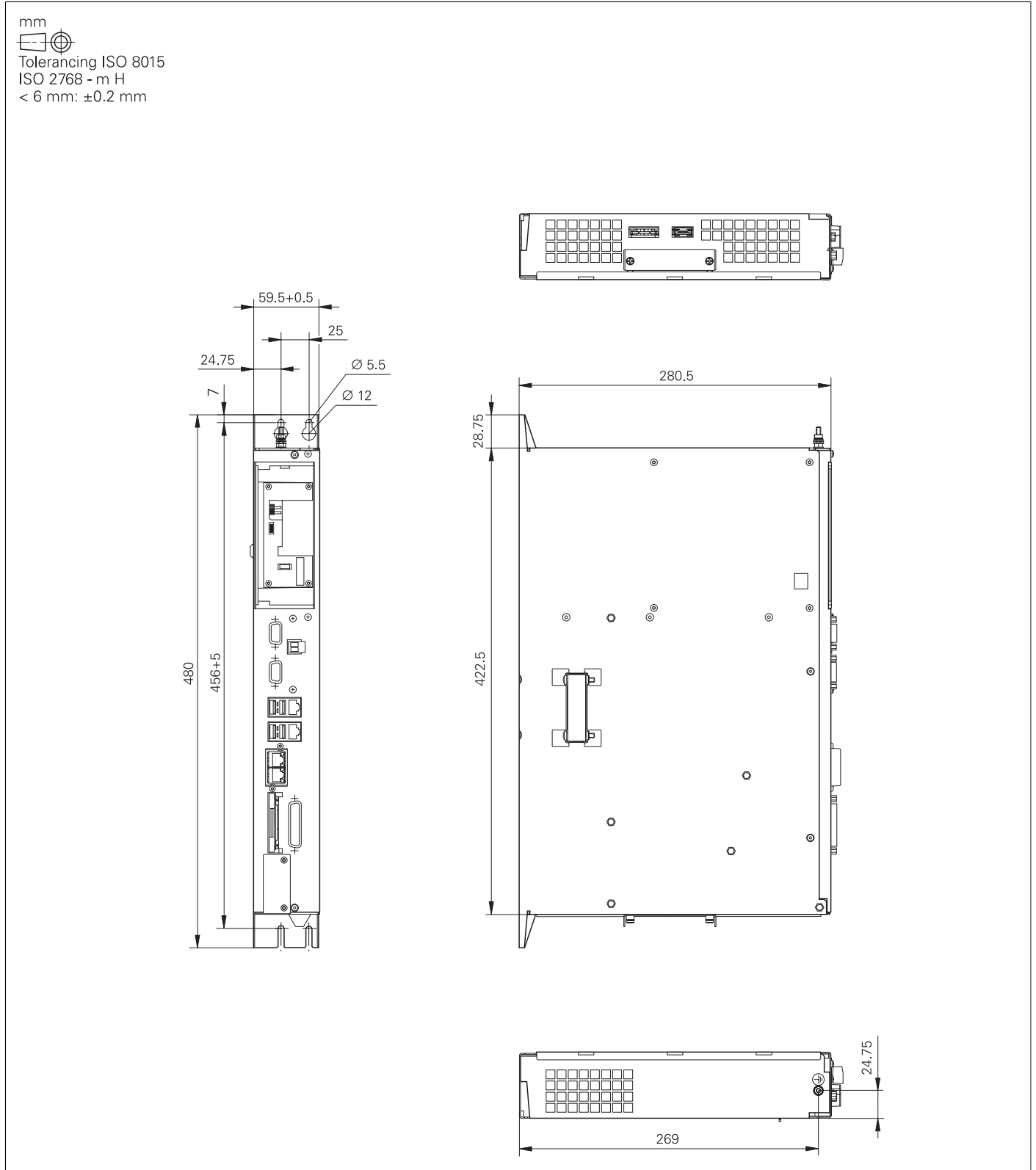

MC 6542

mm



Tolerancing ISO 8015

ISO 2768 - m H

< 6 mm: ±0.2 mm

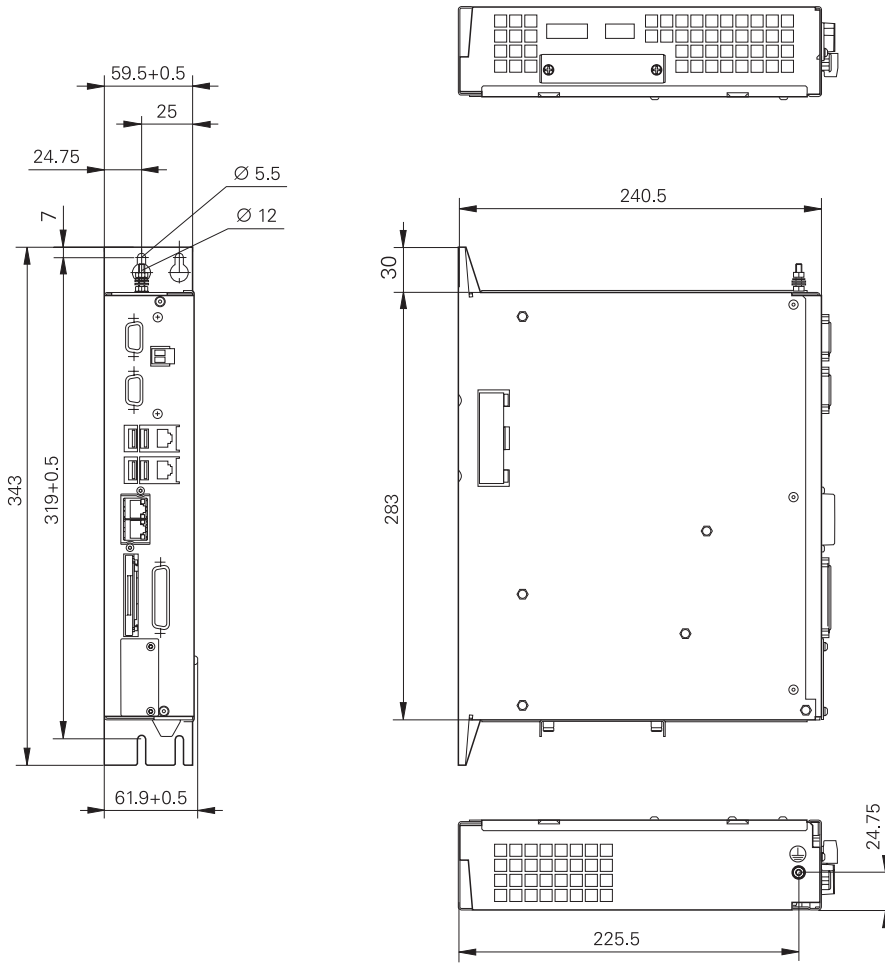

Controller unit

CC 6106

mm



Tolerancing ISO 8015

ISO 2768 - m H

< 6 mm: ± 0.2 mm

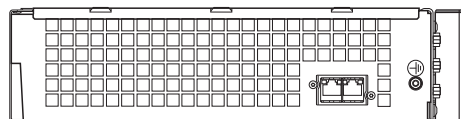
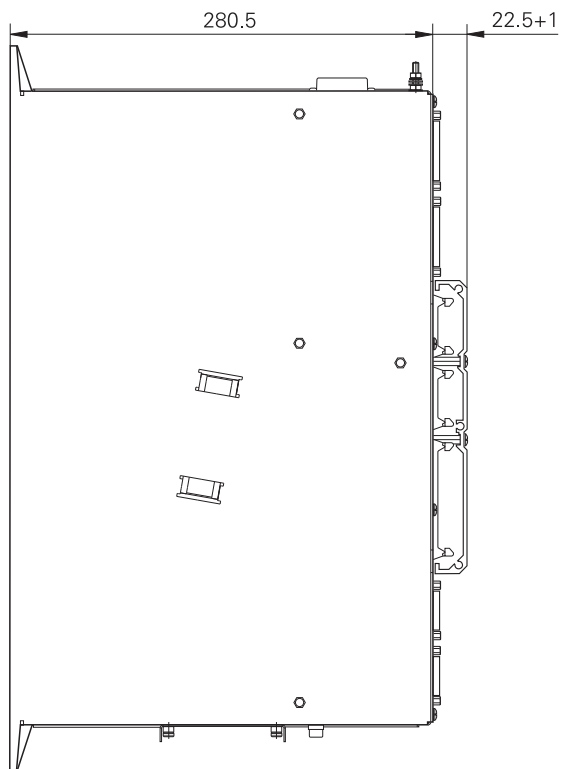
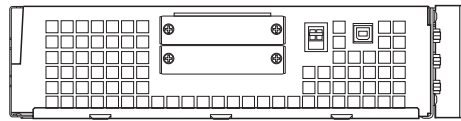
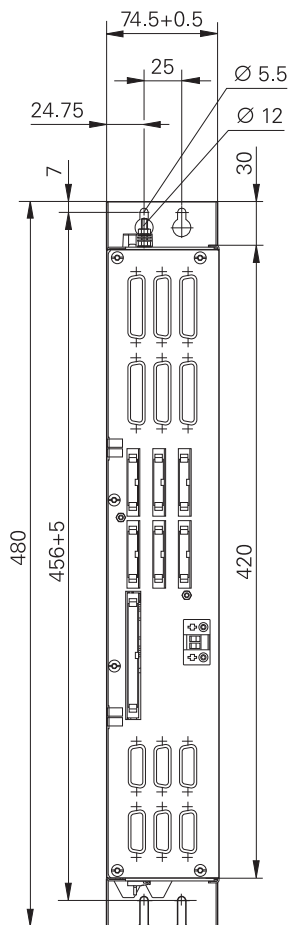

CC 6108, CC 6110

mm

 Tolerancing ISO 8015
 ISO 2768 - m H
 < 6 mm: ±0.2 mm

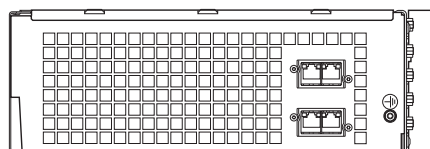
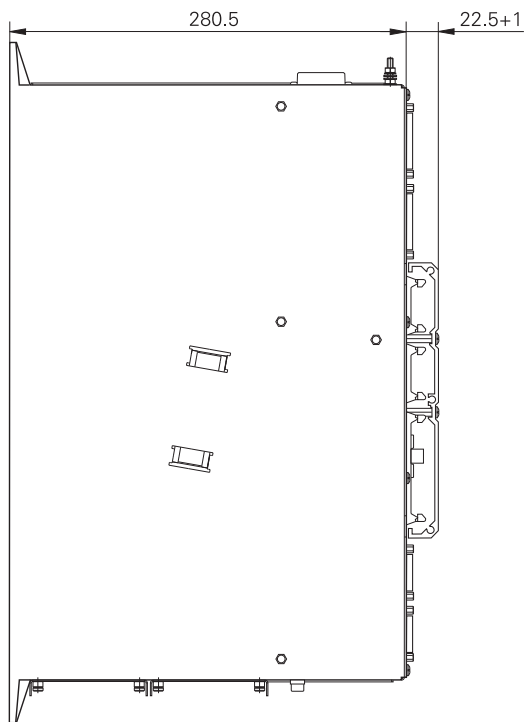
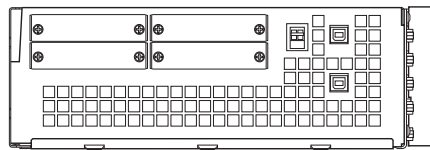
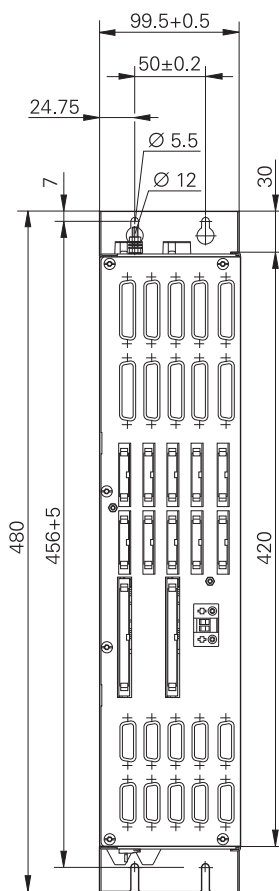
CC 6108: 8 control loops
 CC 6110: 10 control loops

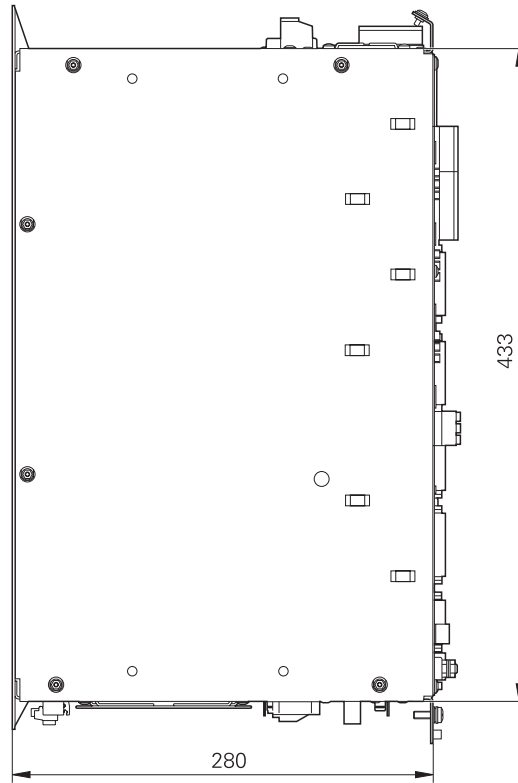
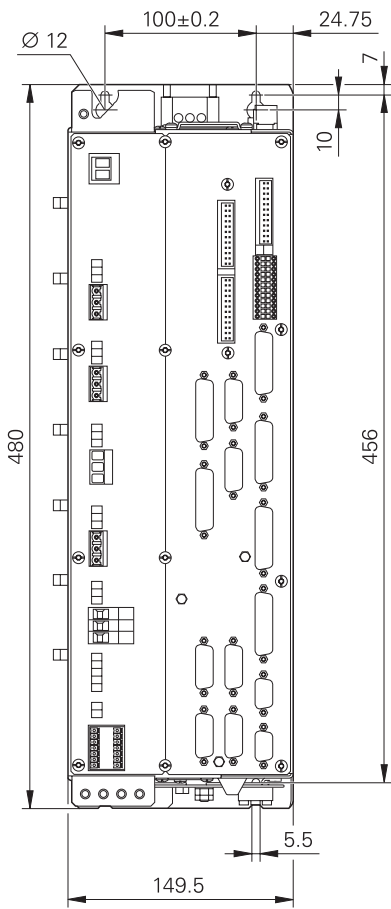

UEC 111, UEC 112, UEC 113

mm
Tolerancing ISO 8015
ISO 2768 - m H
< 6 mm: ±0.2 mm



UMC 111

mm



Tolerancing ISO 8015

ISO 2768 - m H

< 6 mm: ±0.2 mm

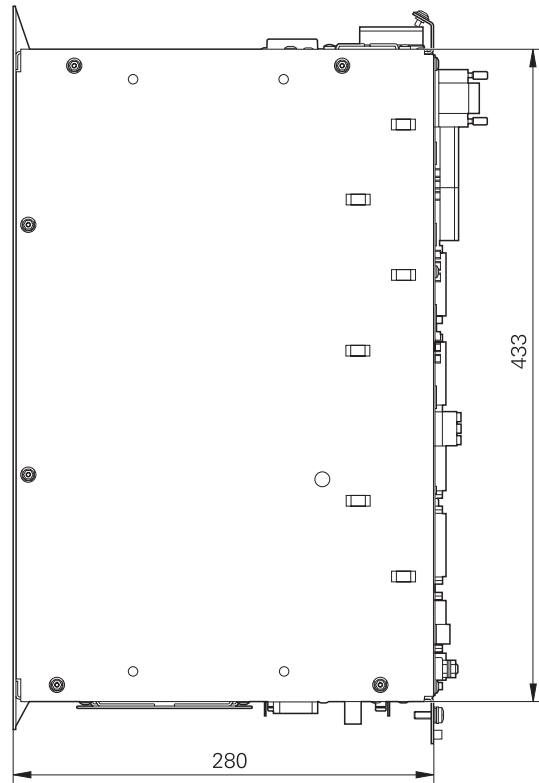
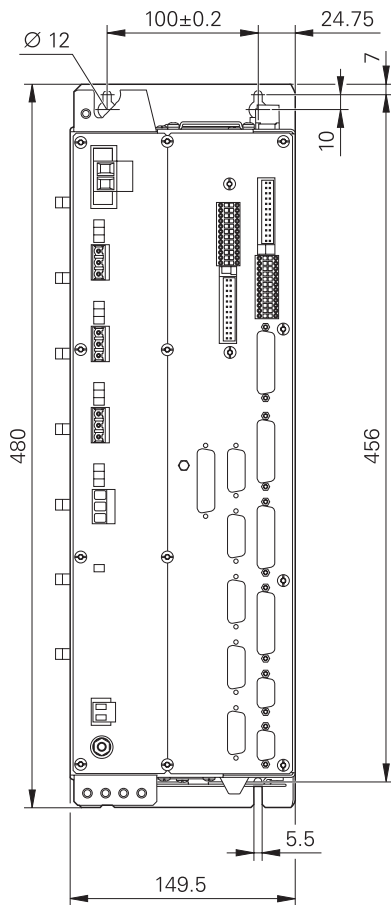

Operating station, keyboard and screen

ITC 755

mm

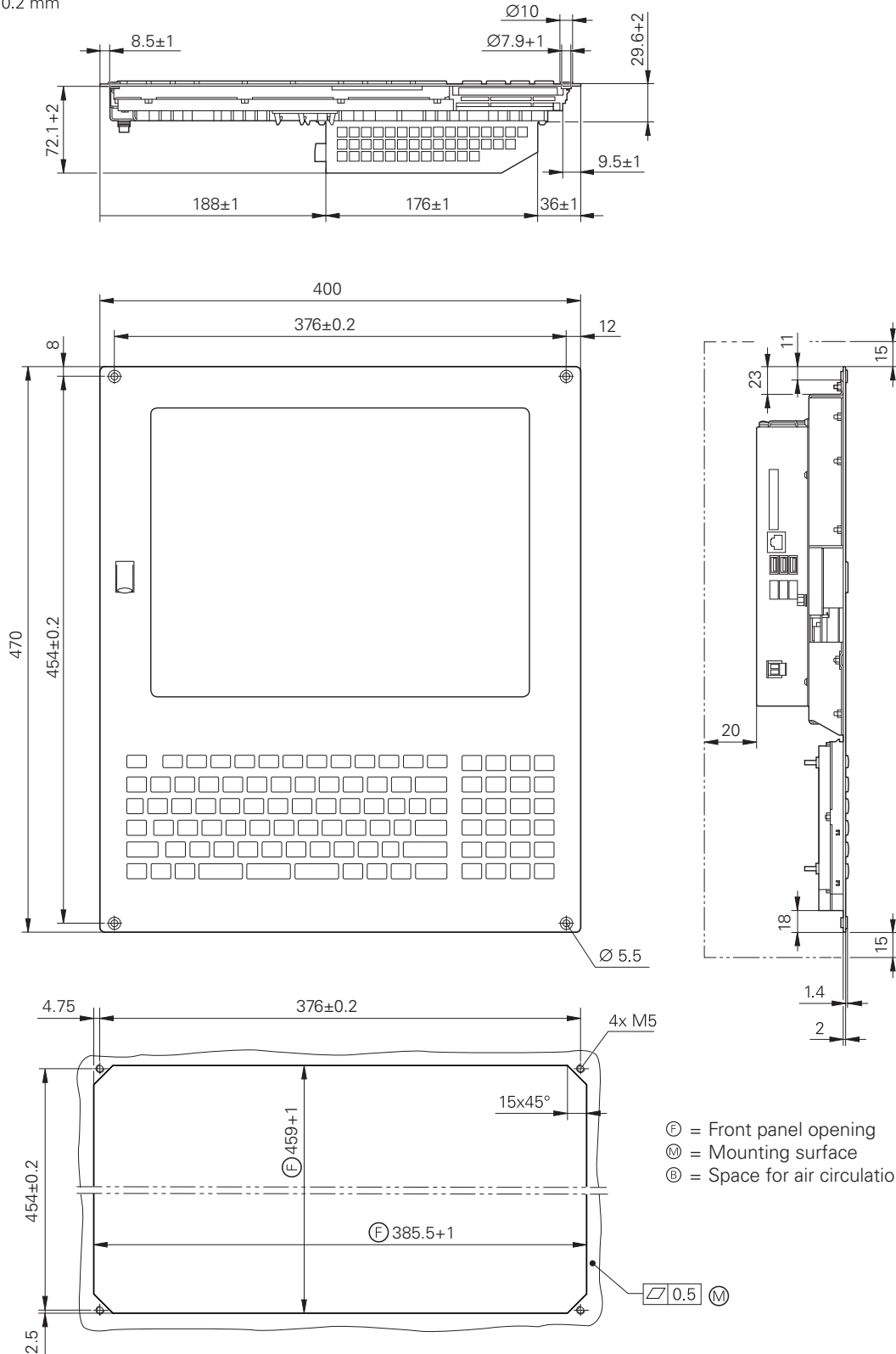
 Tolerancing ISO 8015
 ISO 2768 - m H
 < 6 mm: ±0.2 mm

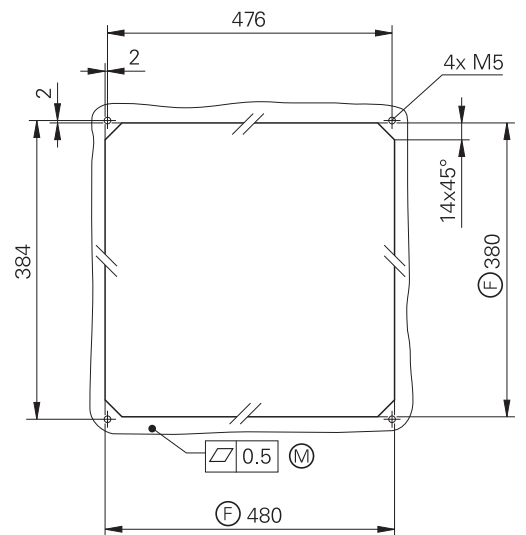
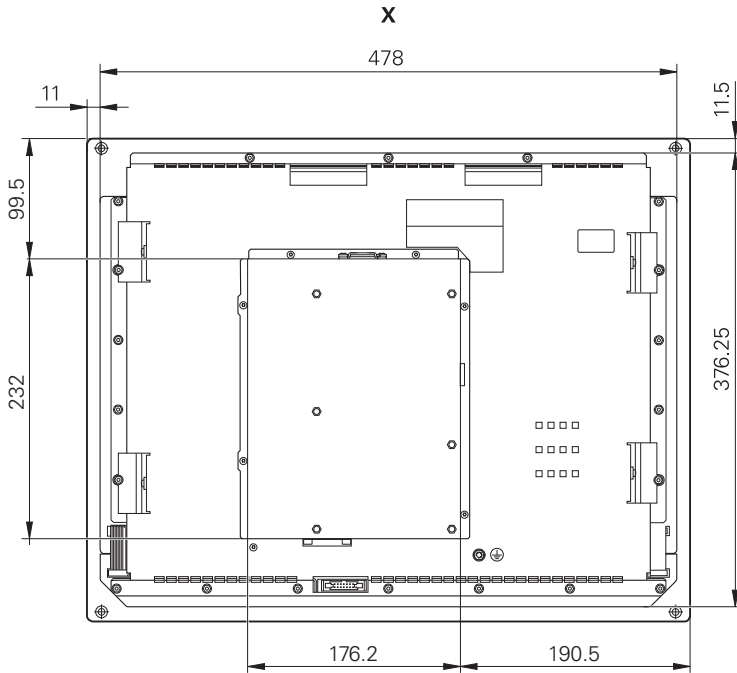
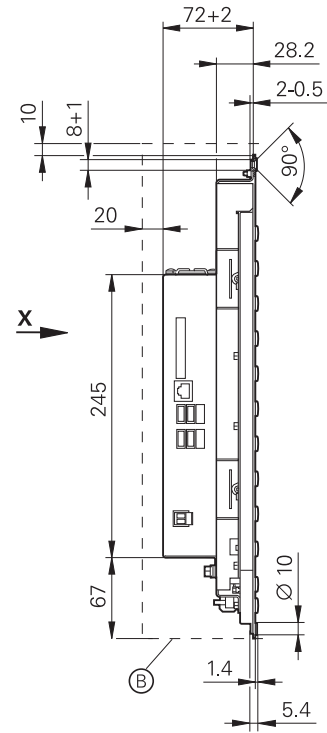
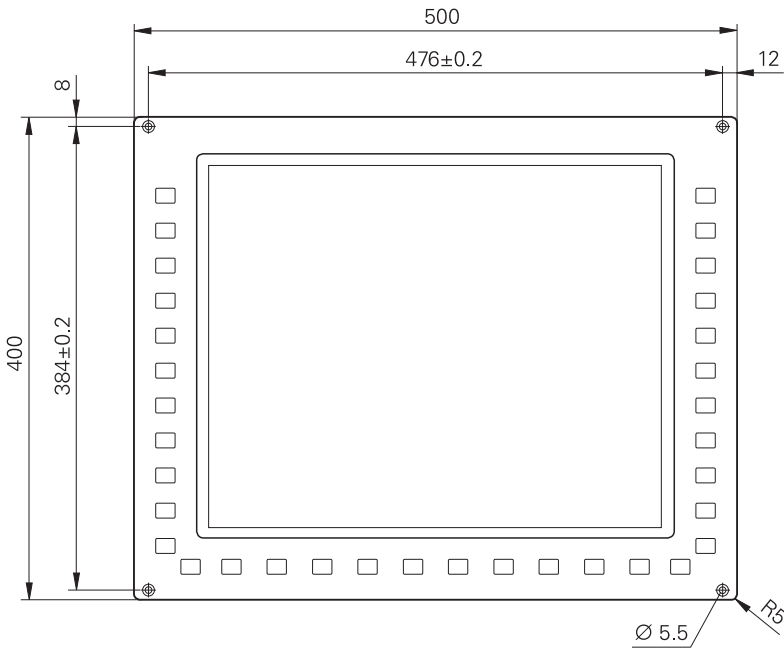

BF 760, ITC 760

mm

 Tolerancing ISO 8015
 ISO 2768 - m H
 < 6 mm: ±0.2 mm



- ⓕ = Front panel opening
- Ⓜ = Mounting surface
- ⓐ = Space for air circulation

TE 740

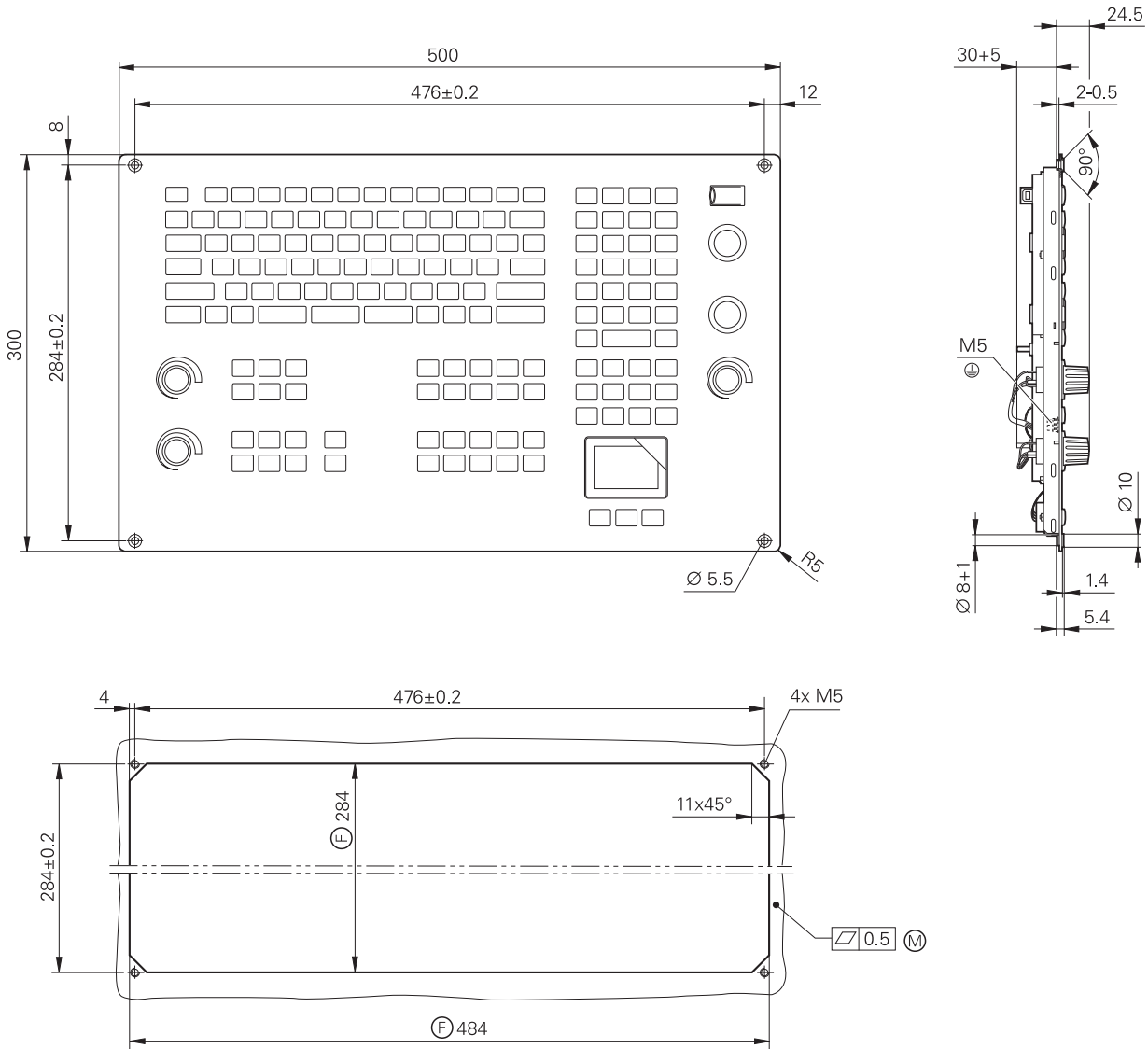
mm

 Tolerancing ISO 8015
 ISO 2768 - m H
 < 6 mm: ±0.2 mm



⊕ = Front panel opening
 ⊗ = Mounting surface

TE 745

mm



Tolerancing ISO 8015

ISO 2768 - m H

< 6 mm: ±0.2 mm

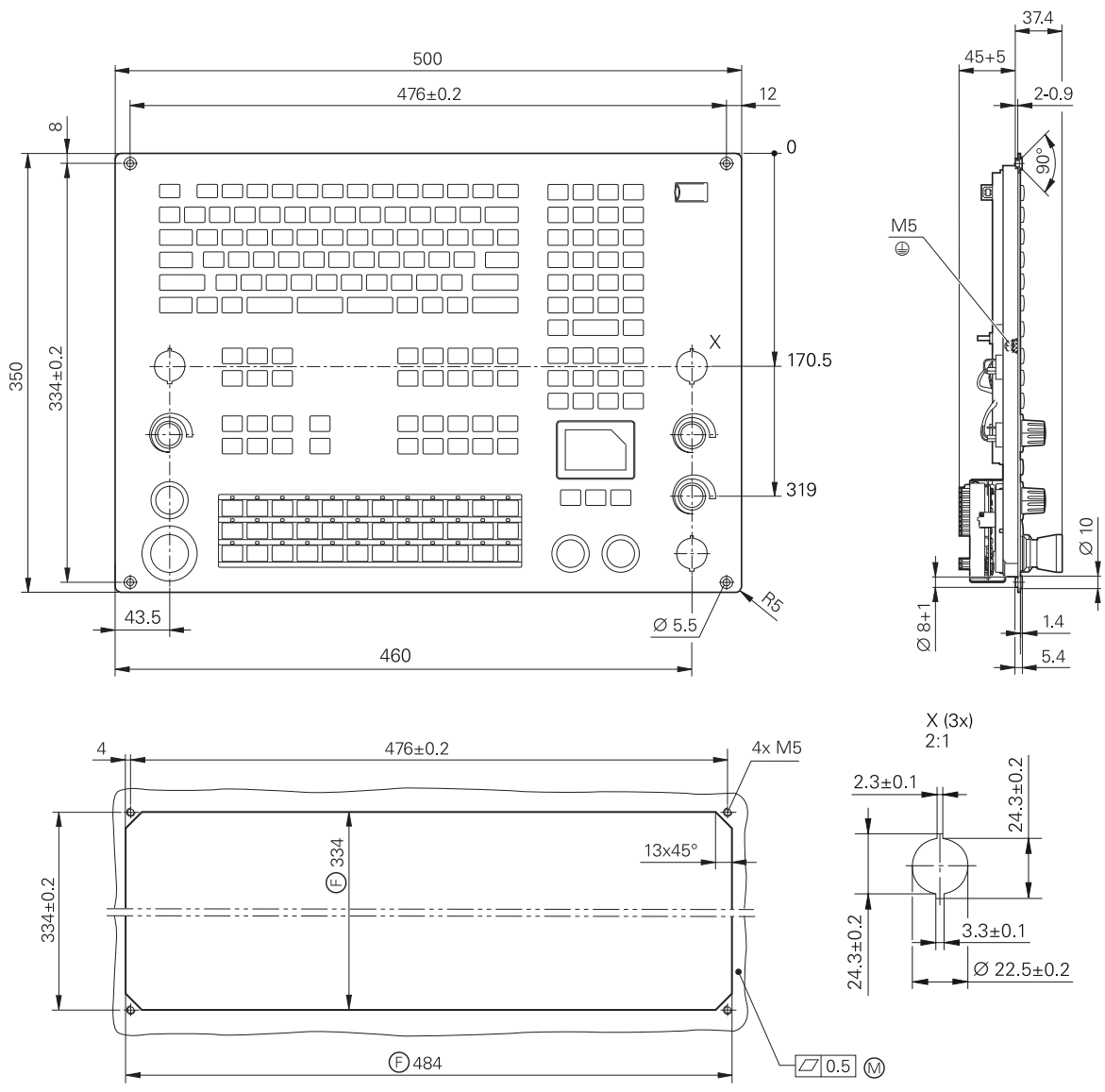

- Ⓢ = Front panel opening
- Ⓜ = Mounting surface

BF 750, ITC 750

mm

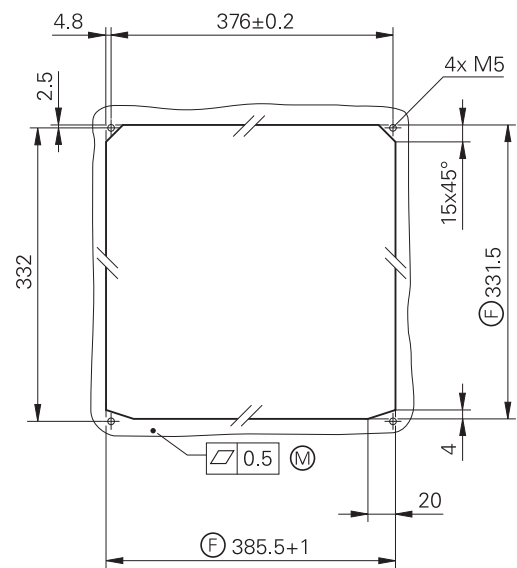
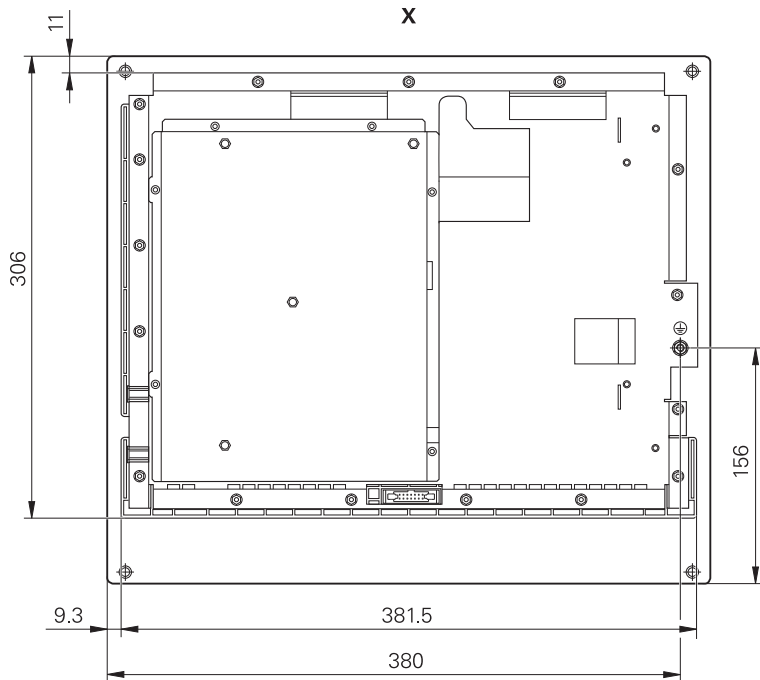
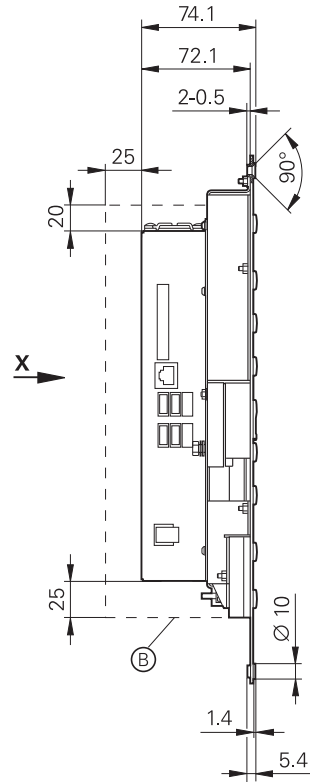
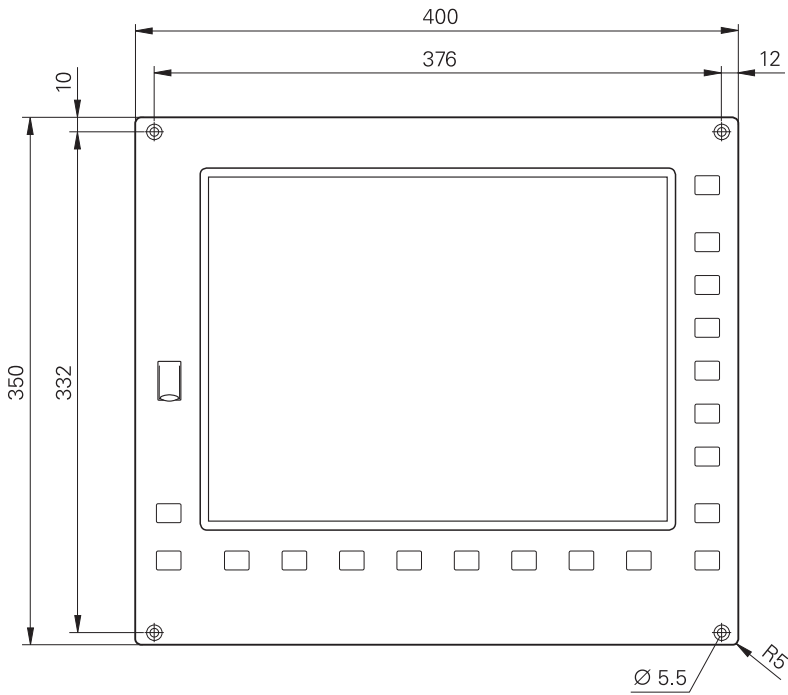
 Tolerancing ISO 8015
 ISO 2768 - m H
 < 6 mm: ±0.2 mm



- ⊕ = Front panel opening
- Ⓜ = Mounting surface
- Ⓟ = Space for air circulation

TE 720, TE 730

mm

 Tolerancing ISO 8015
 ISO 2768 - m H
 < 6 mm: ±0.2 mm

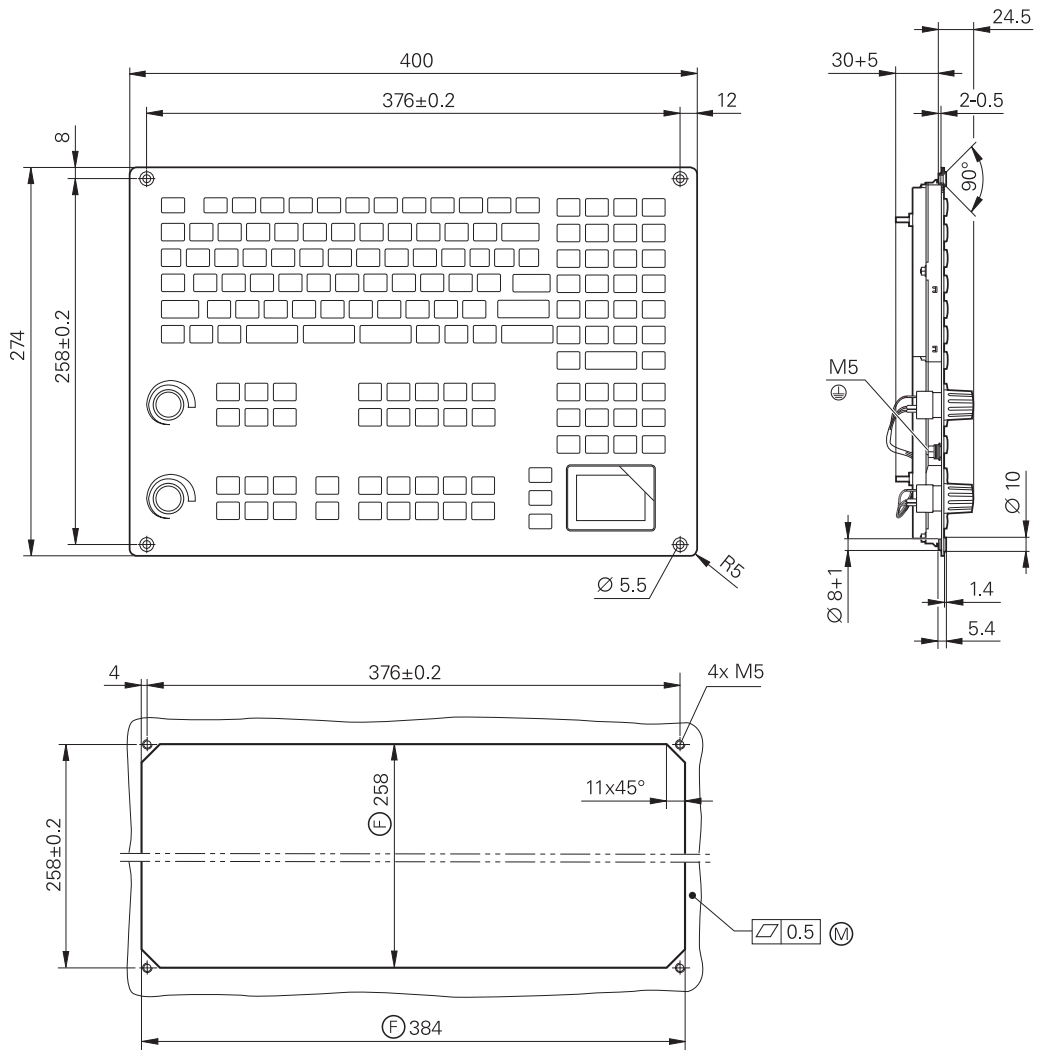
TE 720 B: Without touchpad
 TE 730 B: With touchpad



ⓕ = Front panel opening
 Ⓜ = Mounting surface

TE 735

mm

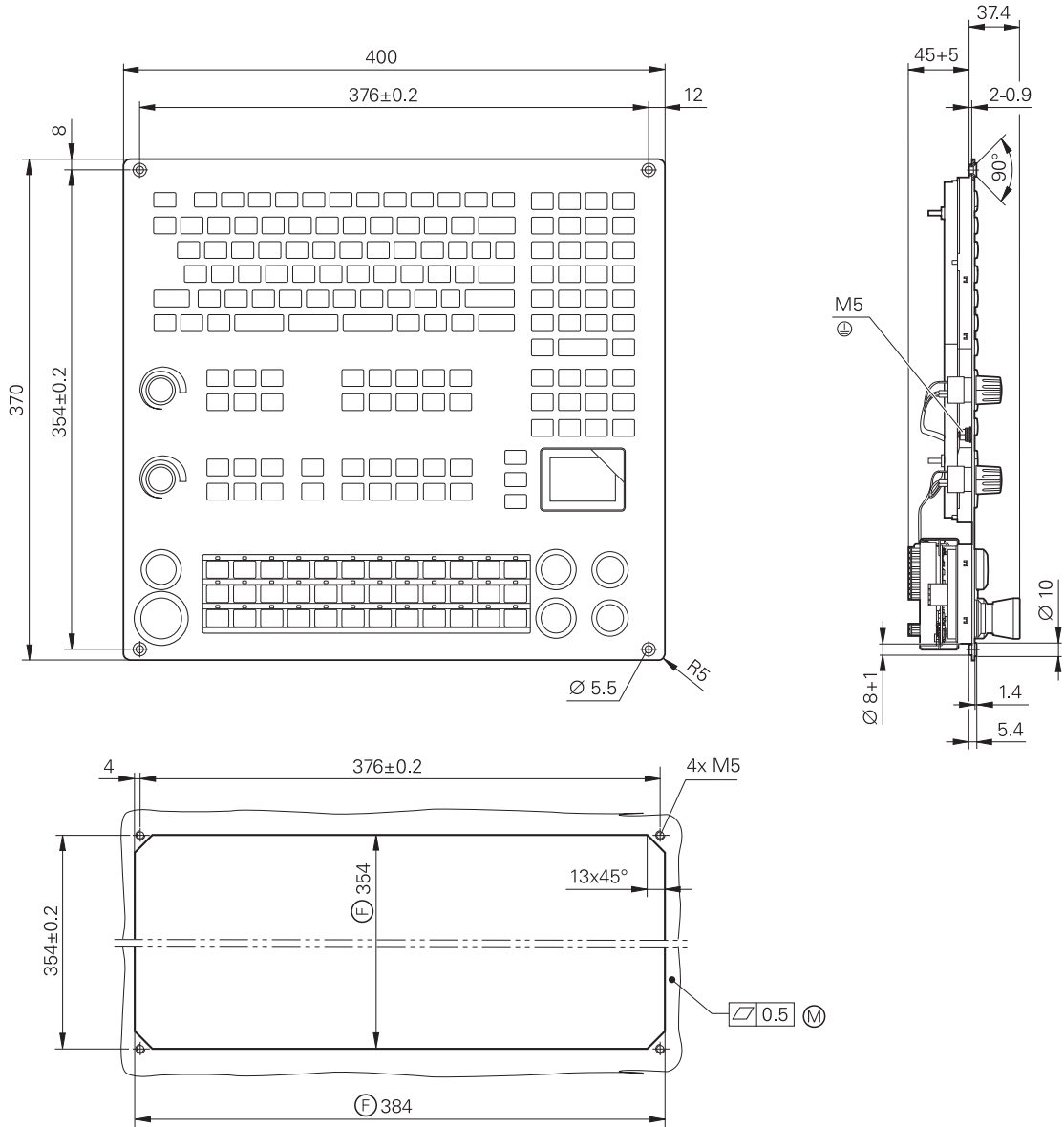
 Tolerancing ISO 8015
 ISO 2768 - m H
 < 6 mm: ±0.2 mm

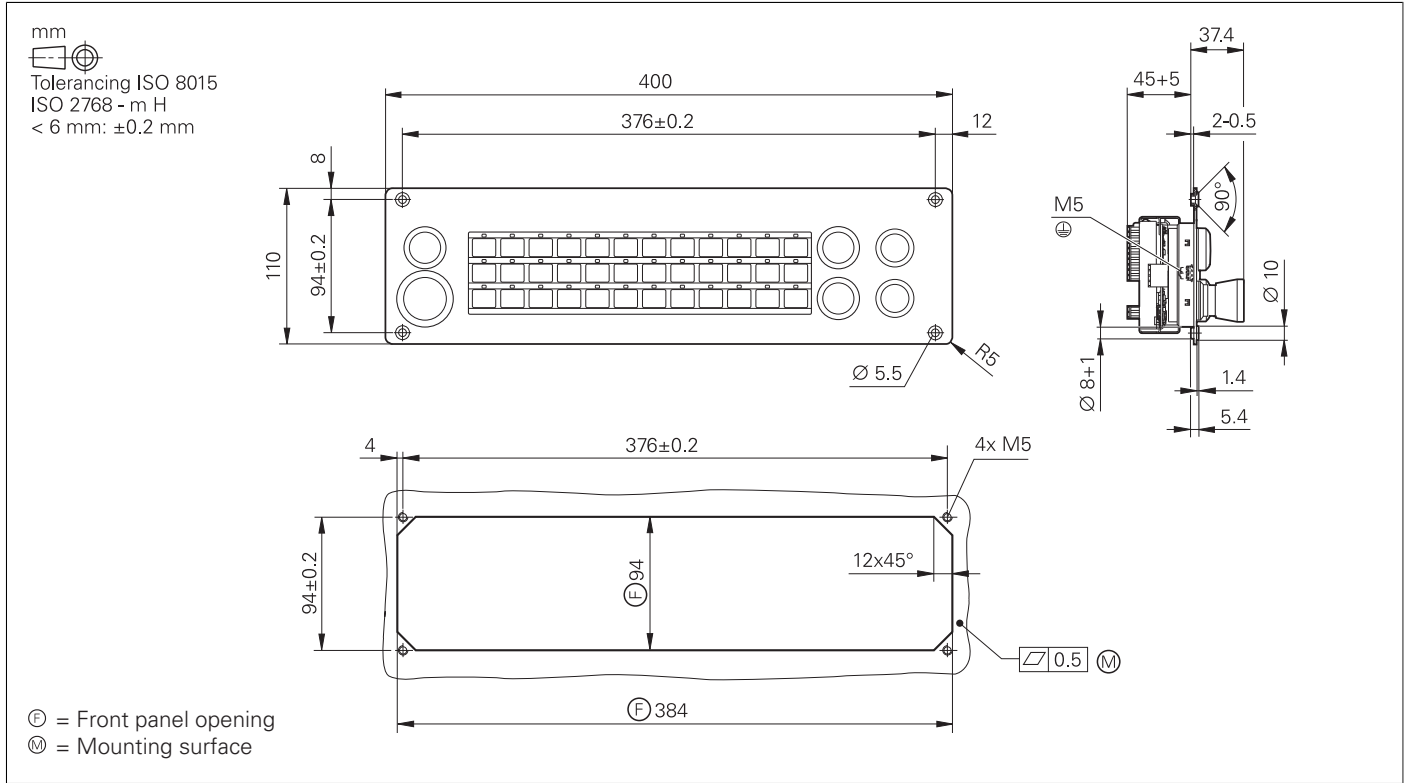

Ⓢ = Front panel opening
 Ⓜ = Mounting surface

MB 720



PLB 6001

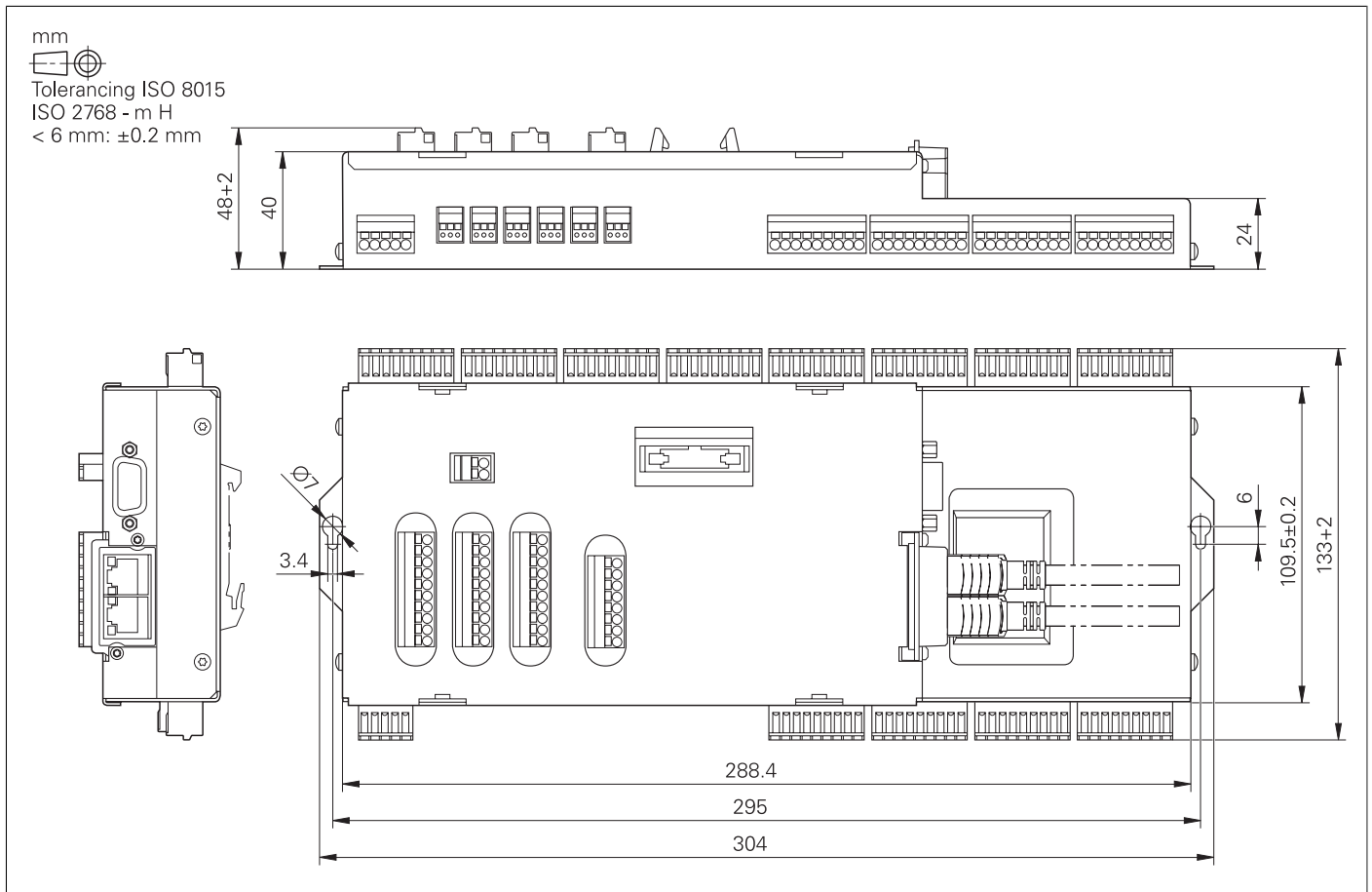

PLC inputs and outputs

PL 6000 (PLB 62xx, PLB 61xx)

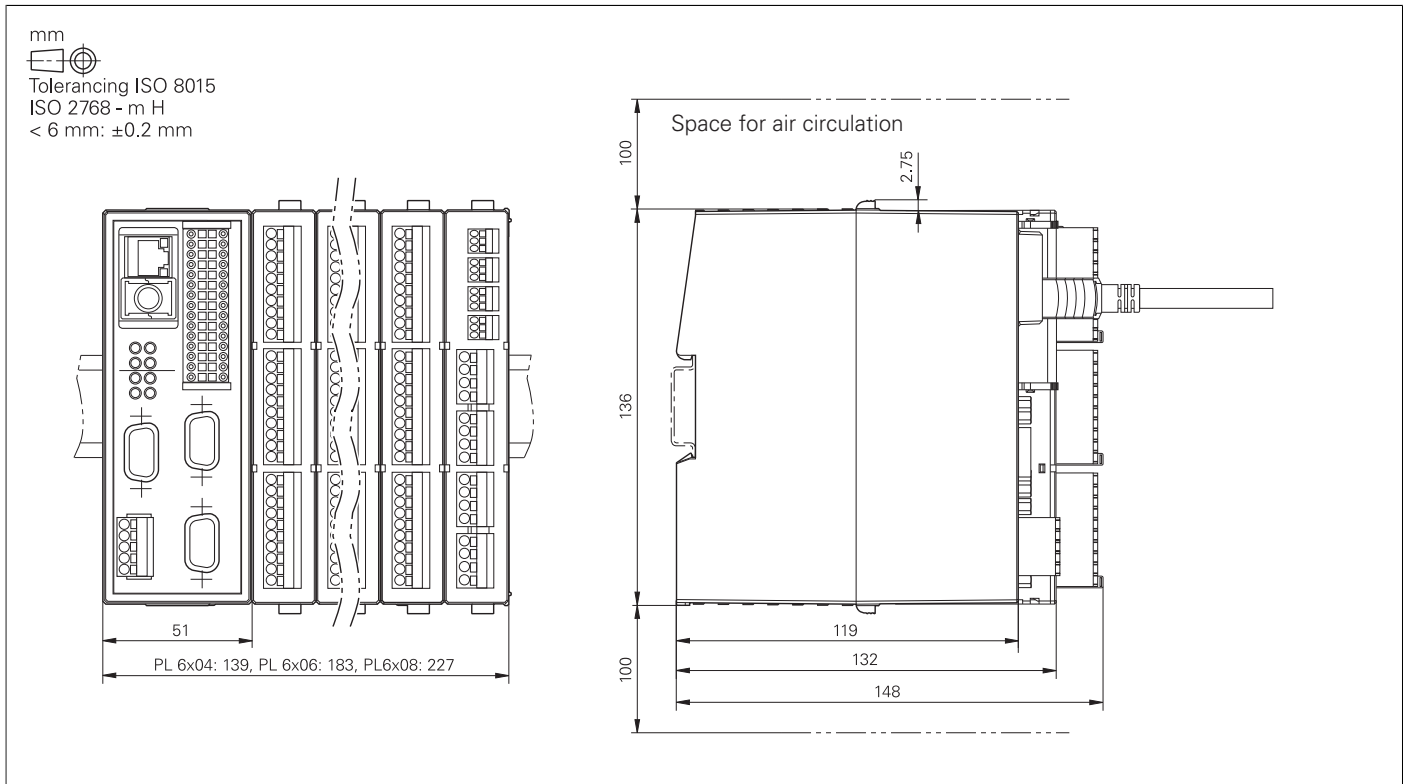

PL 550

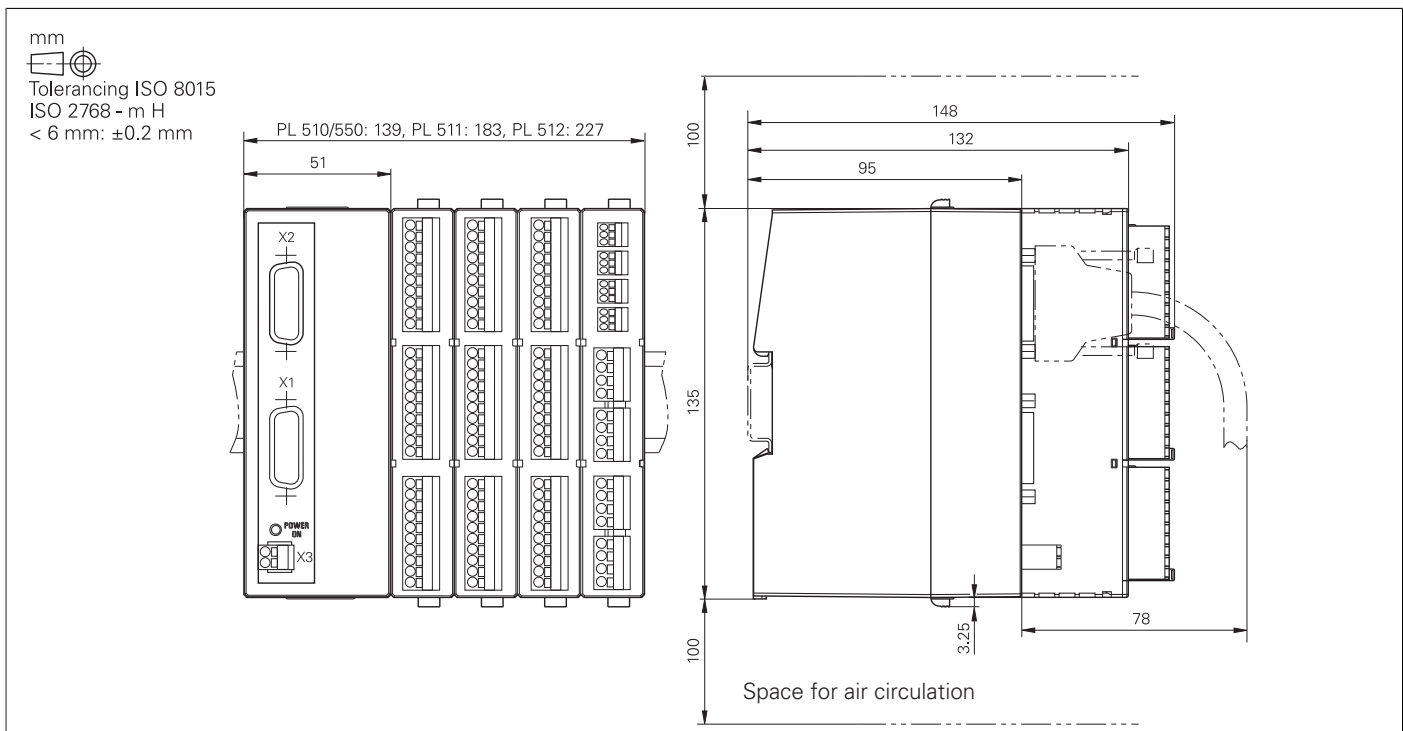

Power supply units

PSL 130

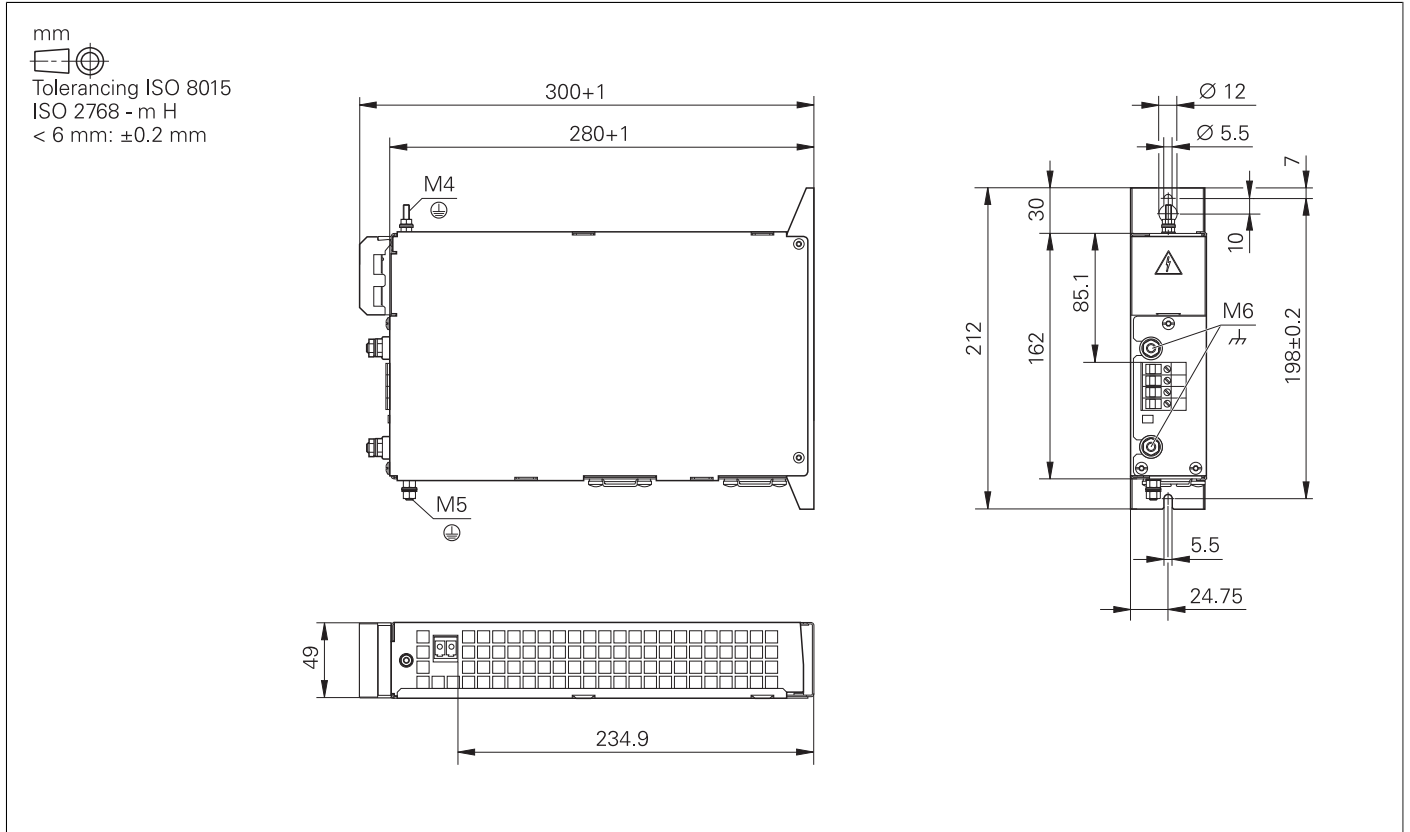

PSL 135

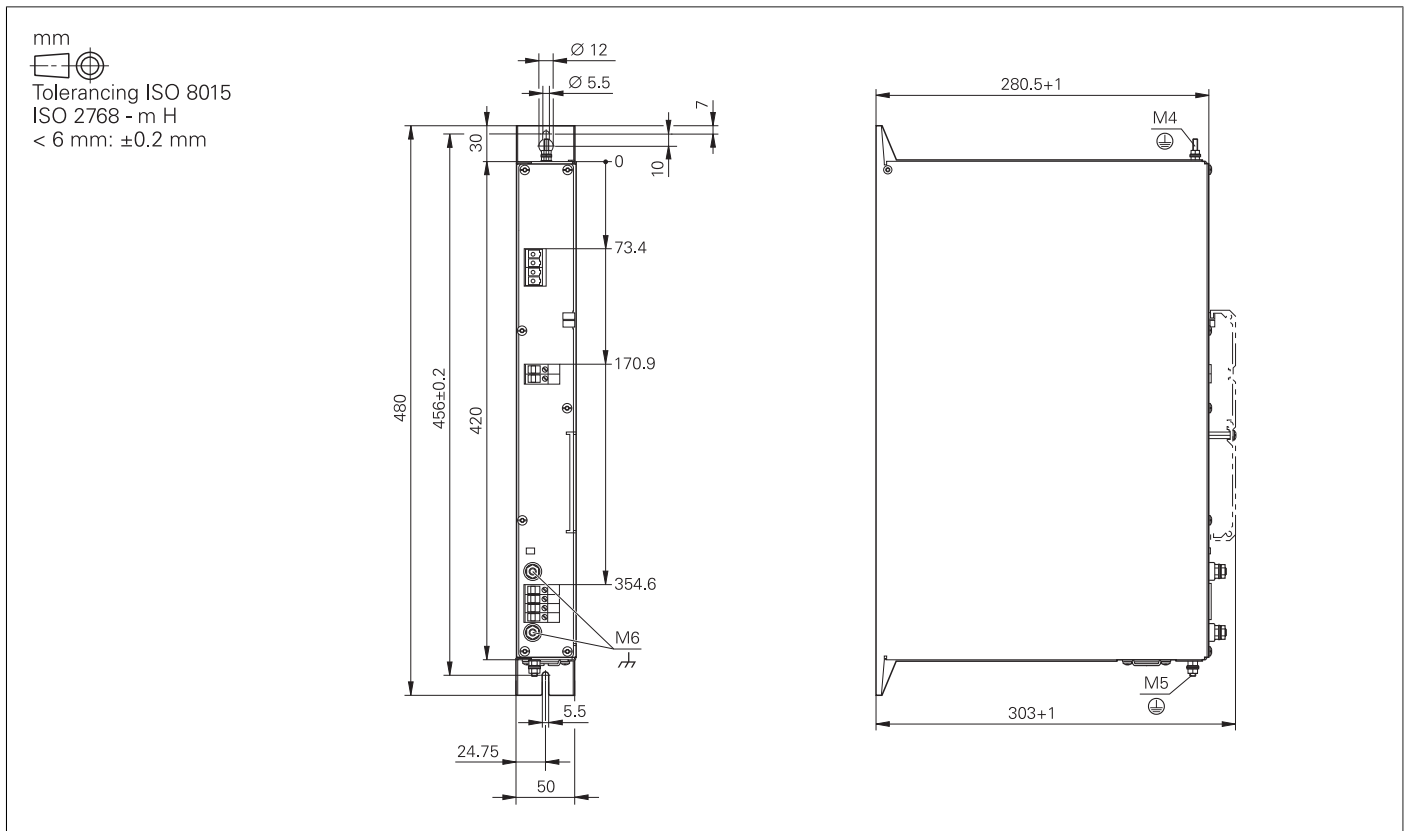

Electronic handwheels

HR 410

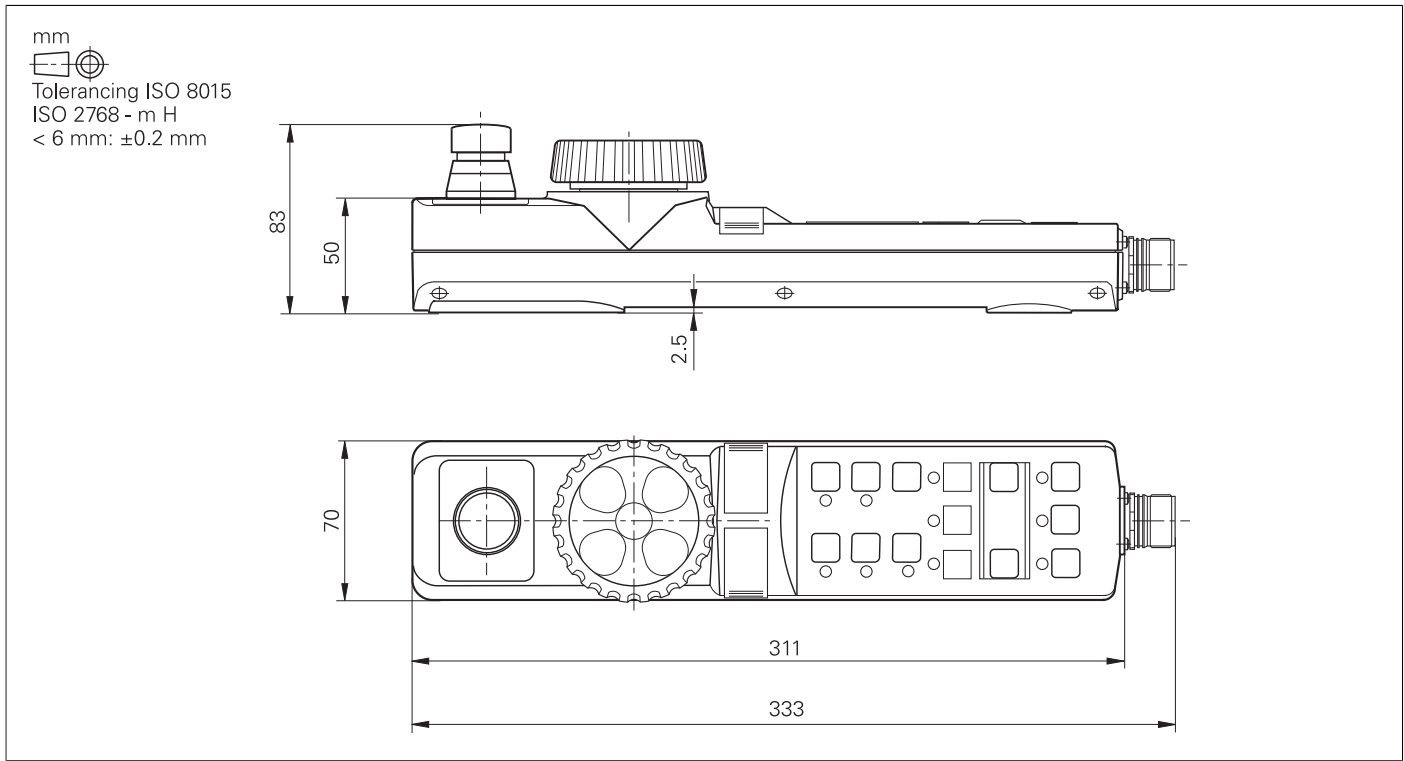

Adapter cable for HR 410 and HR 520

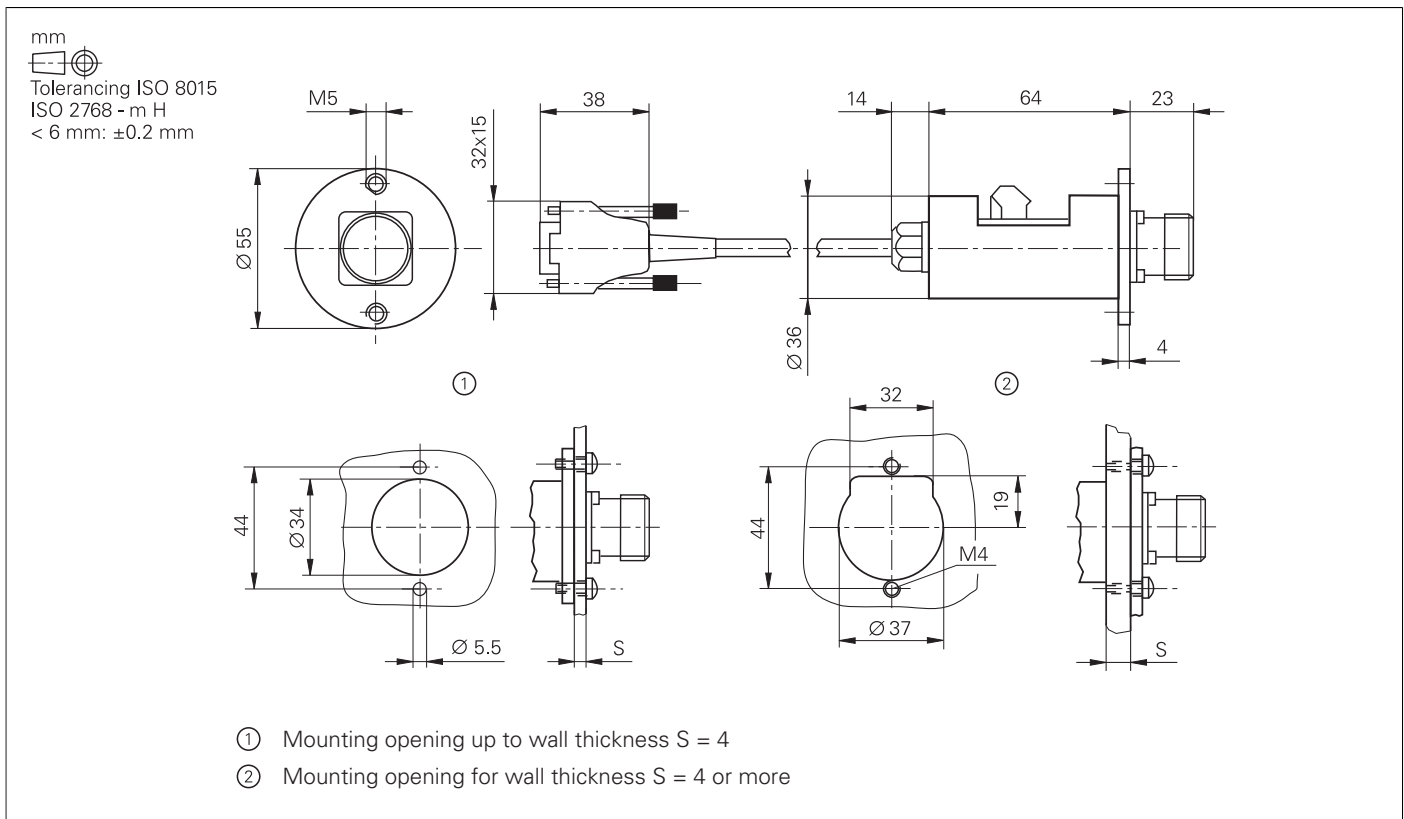

HR 520

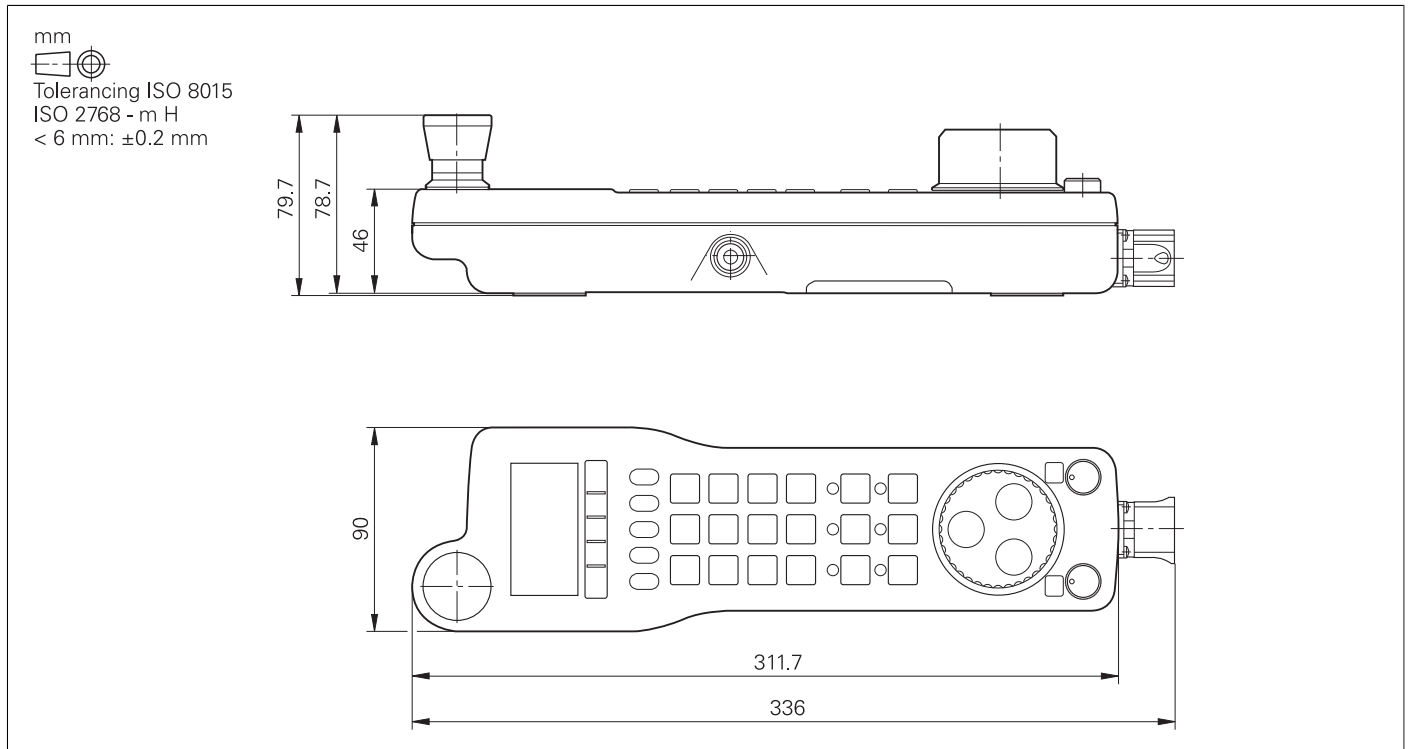

Mount for HR 520

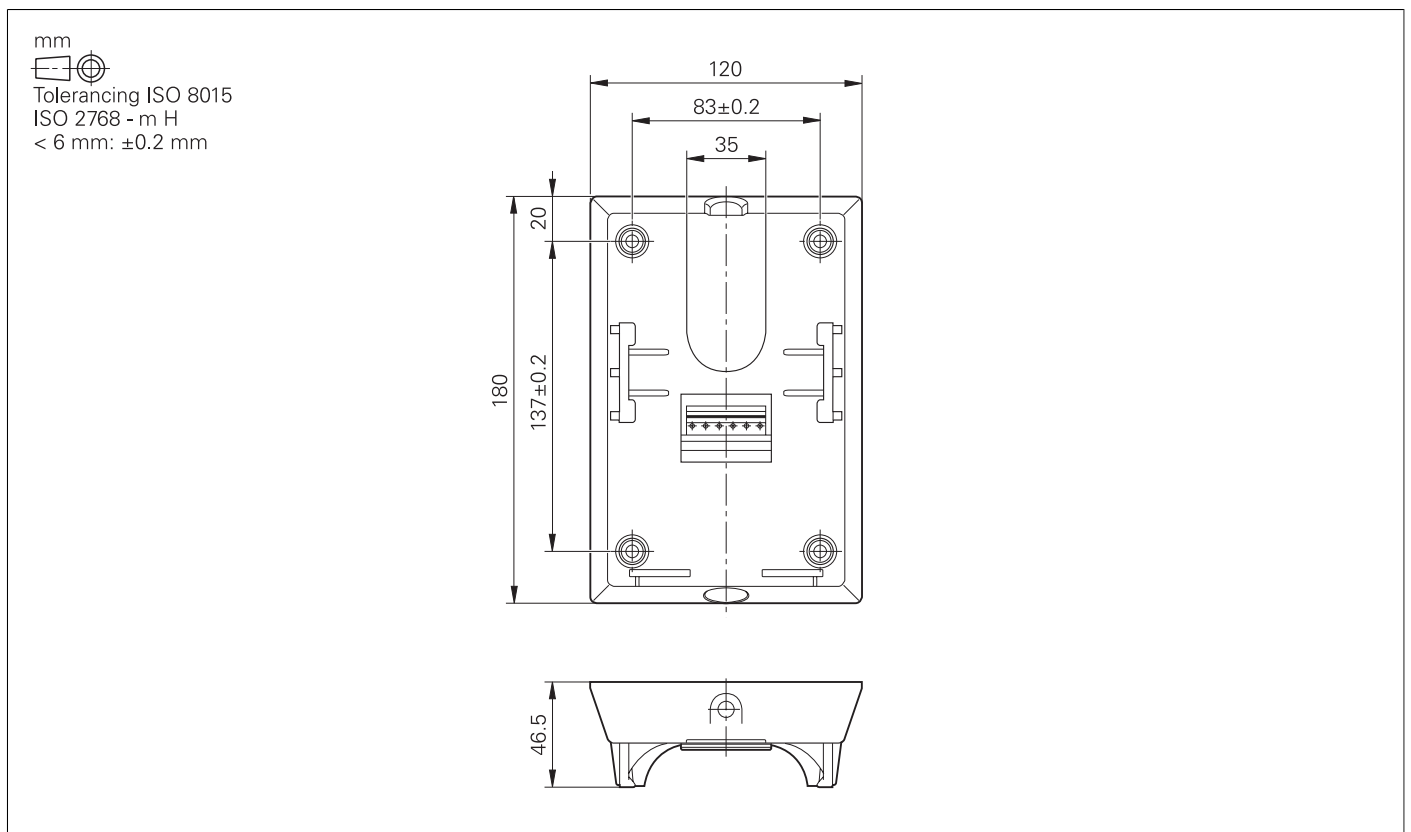

HR 550 FS

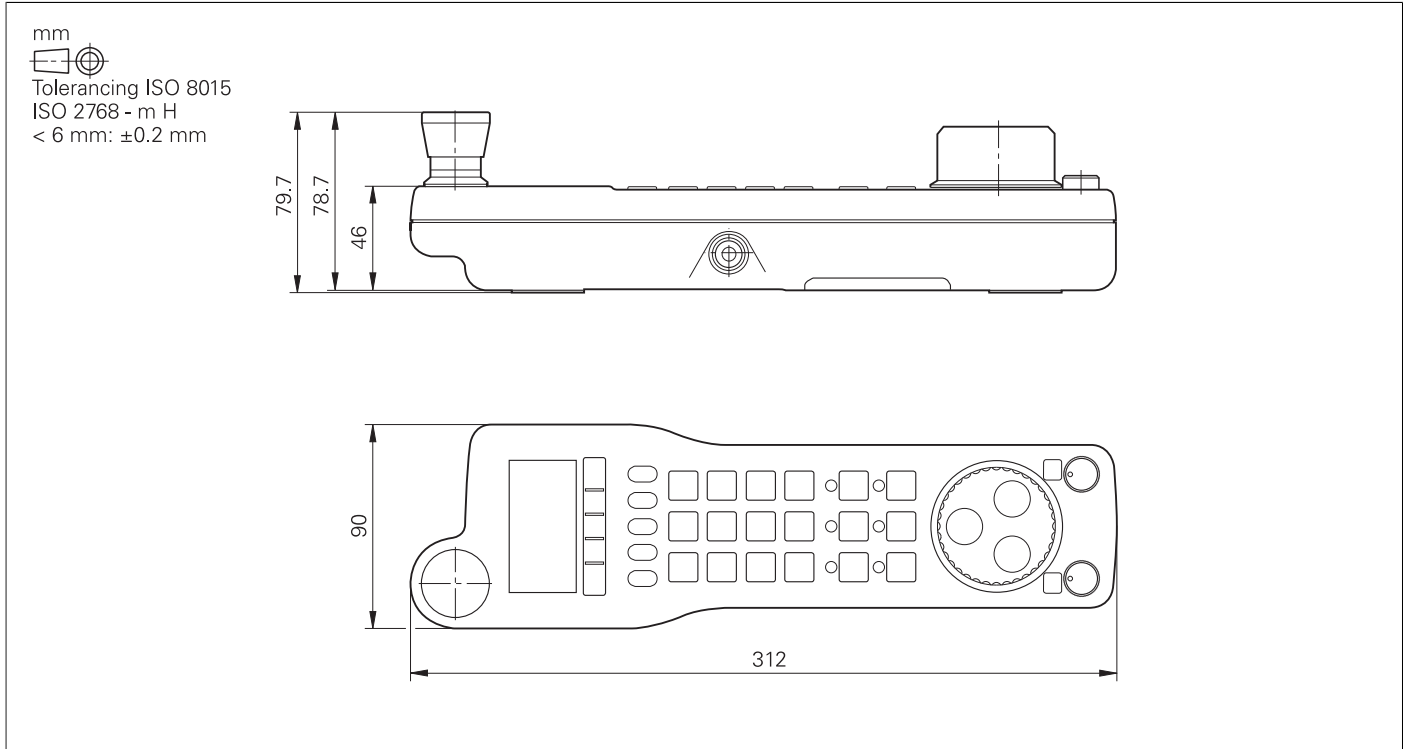

HRA 551 FS

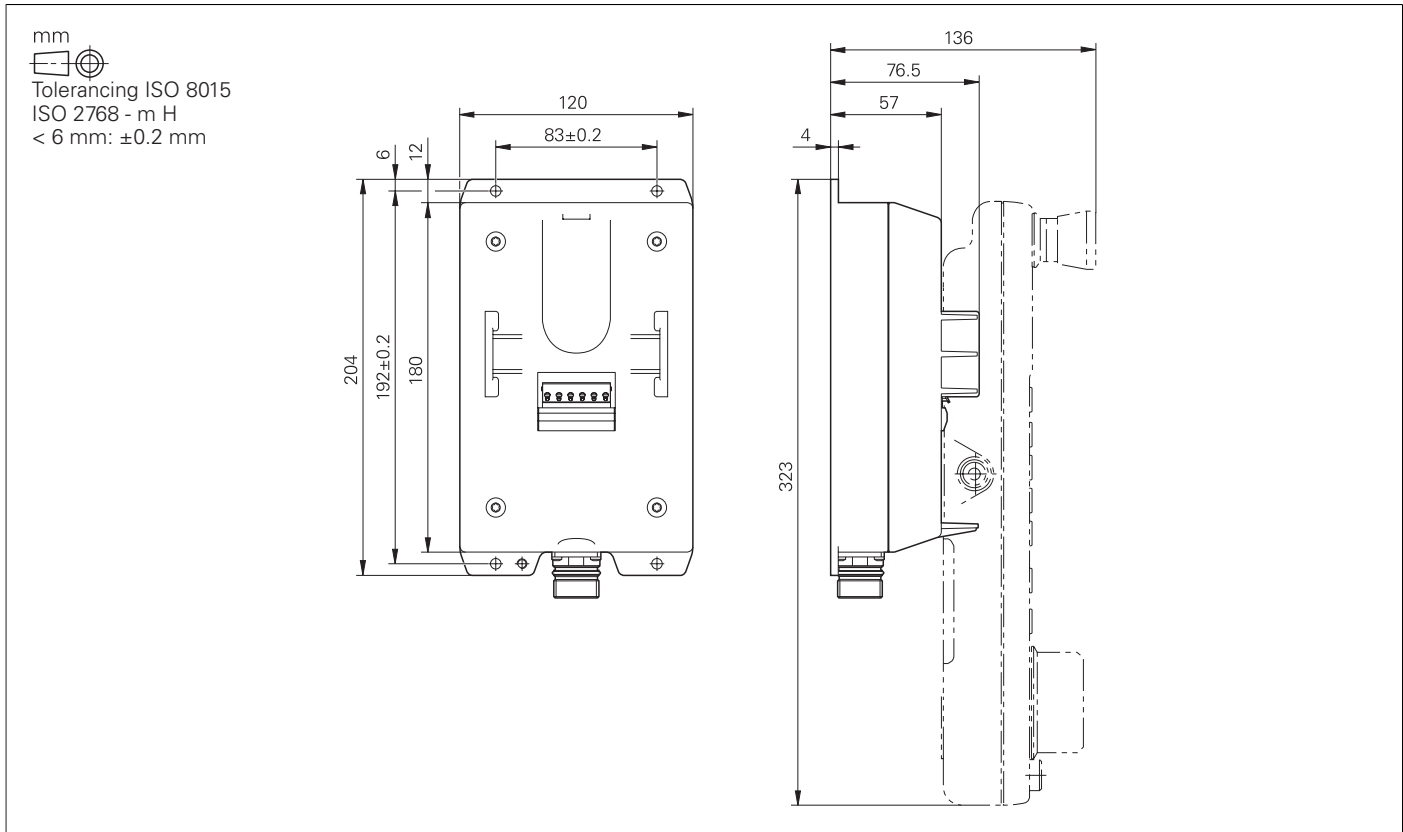

HR 130, HR 150 with control knob

mm



Tolerancing ISO 8015

ISO 2768 - m H

< 6 mm: ±0.2 mm

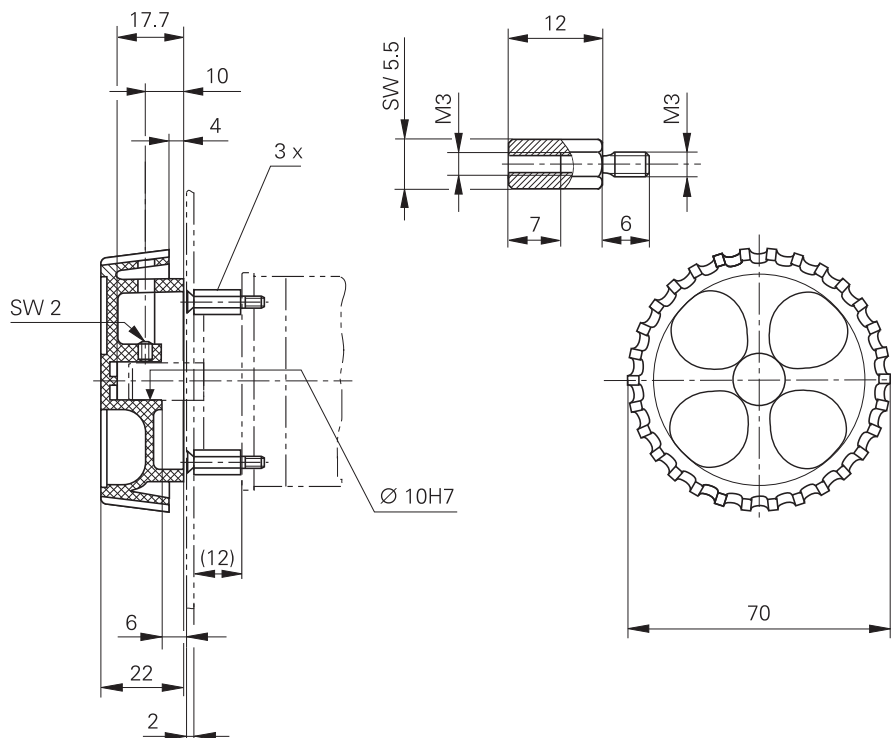
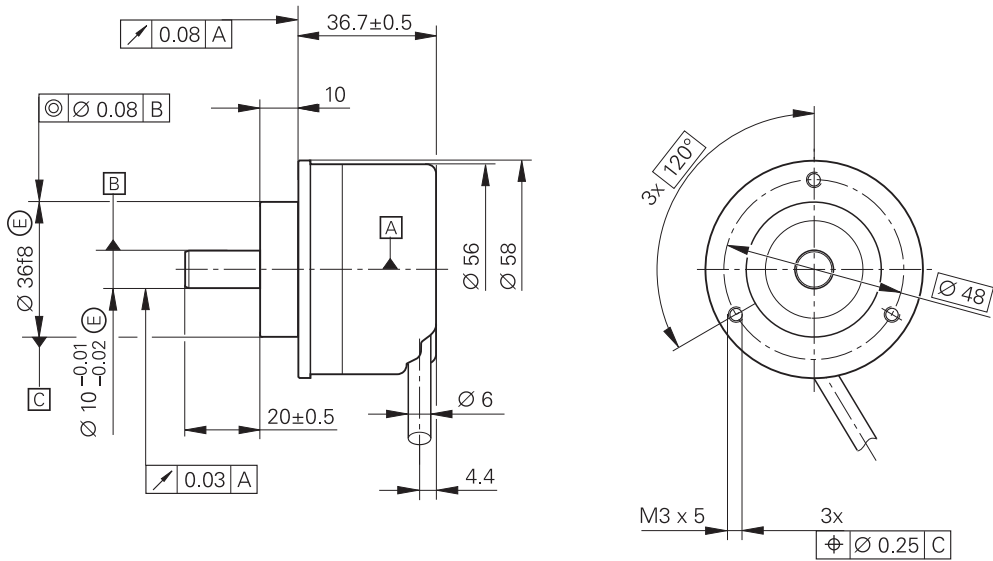

HRA 110

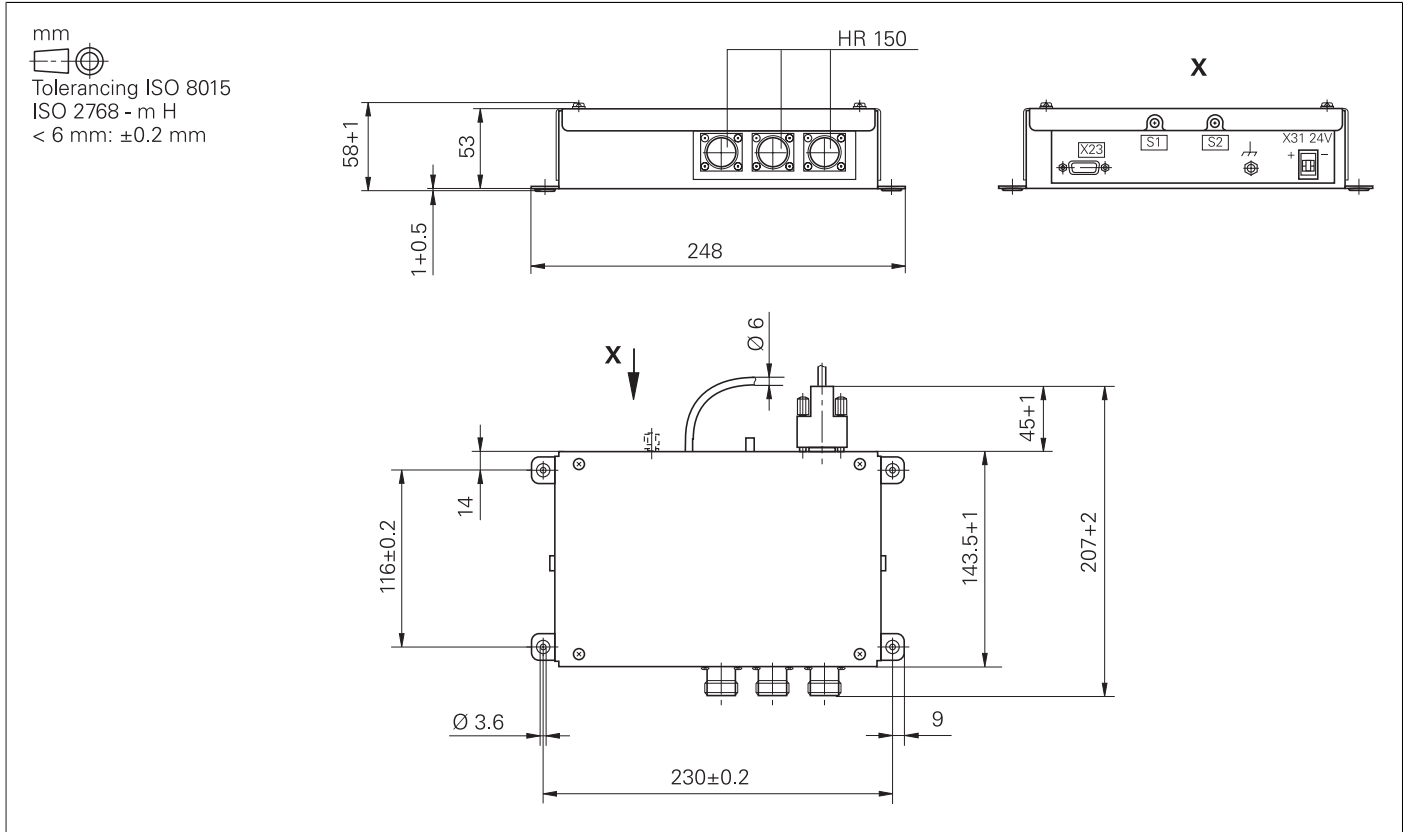

Handwheel selection switch

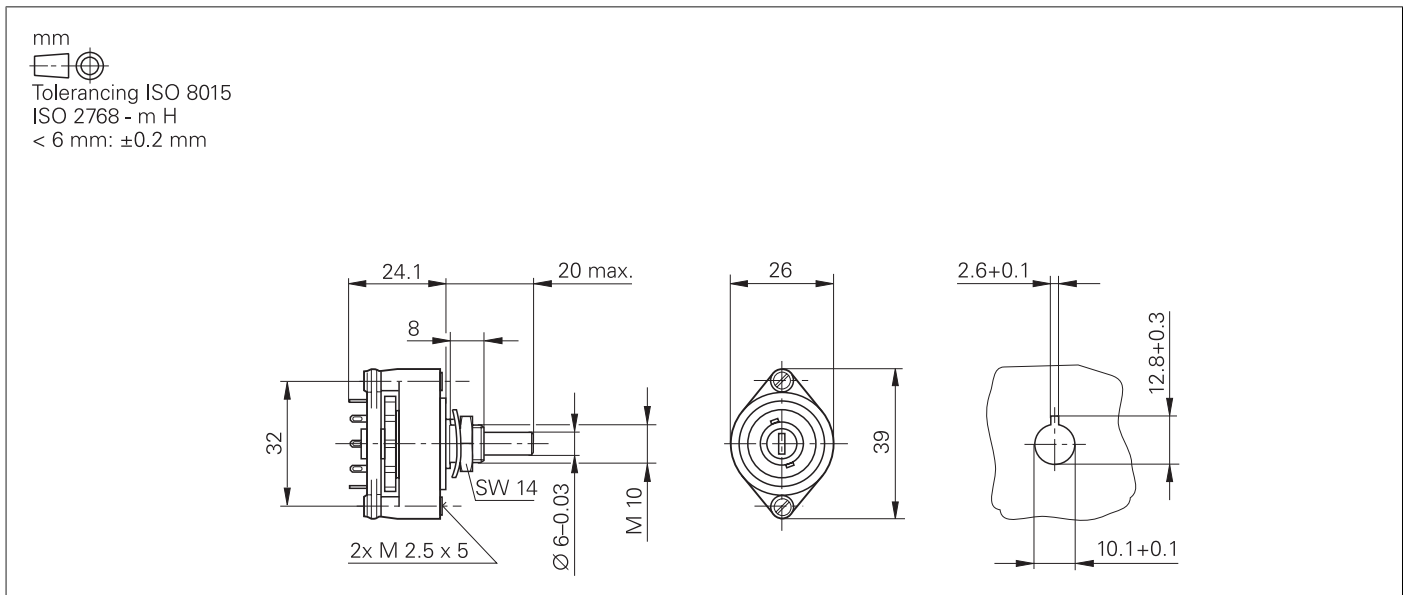

Interface accessories

Line-drop compensator for encoders with EnDat interface

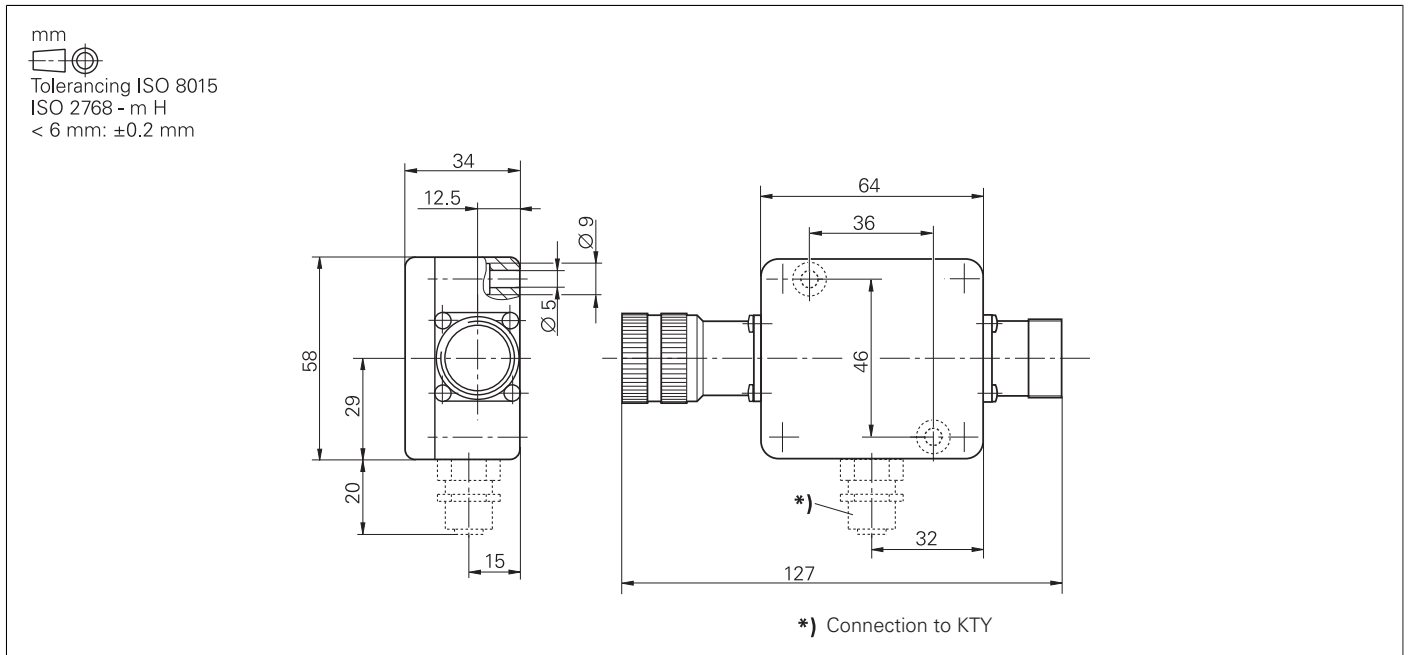

USB hub

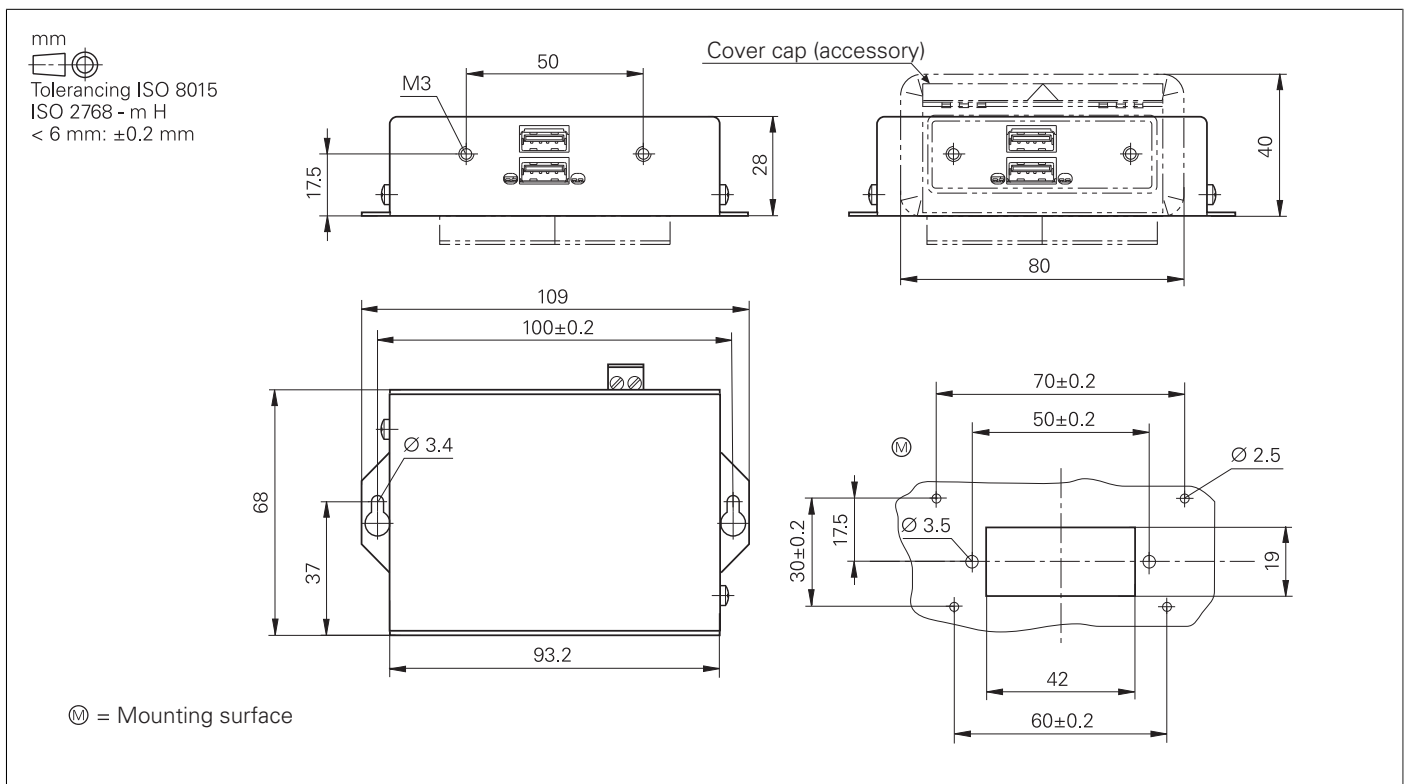

USB extension cable with hubs

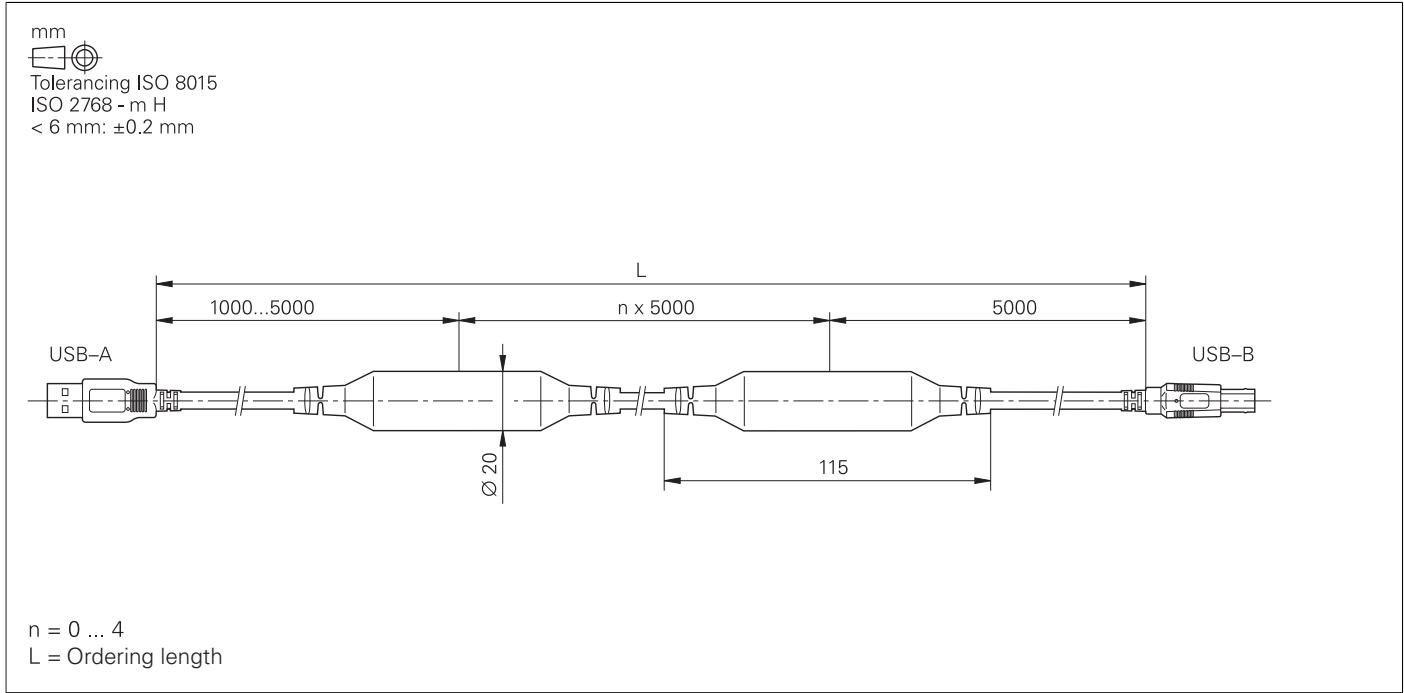

KTY adapter connector

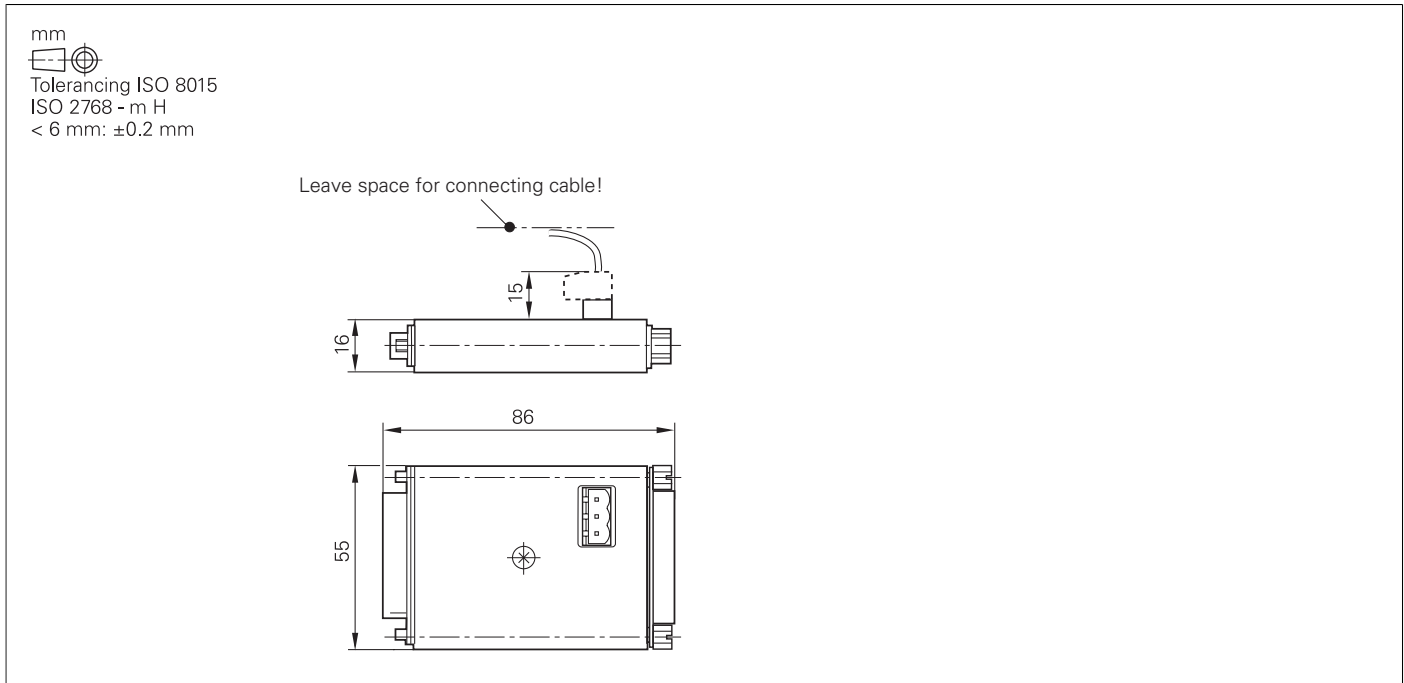

General information

Documentation

Technical documentation	<ul style="list-style-type: none">• iTNC 530 HSCI Technical Manual• Inverter Systems and Motors Technical Manual• Functional Safety Technical Manual• TS 260 Mounting Instructions• TS 460 Mounting Instructions• TS 444 Mounting Instructions• TS 642 Mounting Instructions• TS 740 Mounting Instructions• TT 160 Mounting Instructions• TT 460 Mounting Instructions	ID 801739-xx; in PDF format on HESIS-Web including Filebase ID 208962-xx ID 749363-xx ID 808652-9x ID 808653-9x ID 632757-9x ID 666024-9x ID 632761-9x ID 808654-xx ID 808655-xx
User documentation	<p>iTNC 530</p> <ul style="list-style-type: none">• Conversational Programming User's Manual• Cycle Programming User's Manual• DIN/ISO User's Manual• smarT.NC Pilot <p>Miscellaneous</p> <ul style="list-style-type: none">• TNCremo User's Manual• TNCremoPlus User's Manual• PLCdesign User's Manual• CycleDesign User's Manual• IOconfig User's Manual• KinematicsDesign User's Manual	<p>For NC software 34049x-xx</p> <p>ID 670387-xx ID 670388-xx ID 670391-xx ID 533191-xx</p> <p>As integrated help As integrated help As integrated help As integrated help As integrated help As integrated help</p>
Other documentation	<ul style="list-style-type: none">• iTNC 530 brochure• Touch Probes brochure• Inverter Systems brochure• Motors brochure• IPC Product Information• HEIDENHAIN DNC brochure• Remote Diagnosis with TeleService Product Overview• Touch Probes CD-ROM• iTNC 530 Presentation CD-ROM• iTNC Programming Station Demo Version CD-ROM• HR 550 FS Product Information• Technical Information: Safety-Related Control Technology• Technical Information: Safety-Related Position Measuring Systems• Technical Information: Uniformly Digital	ID 892921-xx ID 1113984-xx ID 622420-xx ID 208893-xx ID 630601-xx ID 628968-xx ID 348236-xx ID 344353-xx ID 373080-xx ID 384565-xx PDF PDF PDF PDF

Service and training

Technical support	HEIDENHAIN offers the machine manufacturer technical support to optimize the adaptation of the TNC to the machine, including on-site support.
Replacement control system	In the event of a fault, HEIDENHAIN guarantees the rapid supply of a replacement control system (usually within 24 hours in Europe).
Hotline	Our service engineers are naturally at your disposal by telephone if you have any questions on the interfacing of the control or in the event of faults.
TNC support	+49 8669 31-3101 E-mail: service.nc-support@heidenhain.de
PLC programming	+49 8669 31-3102 E-mail: service.plc@heidenhain.de
NC programming	+49 8669 31-3103 E-mail: service.nc-pgm@heidenhain.de
Measuring systems	+49 8669 31-3104 E-mail: service.ms-support@heidenhain.de
Lathe controls	+49 8669 31-3105 E-mail: service.lathe-support@heidenhain.de
Machine calibration	On request, HEIDENHAIN engineers will calibrate your machine's geometry, e. g. with a KGM grid encoder.
Seminars	<p>HEIDENHAIN provides technical customer training in the following subjects:</p> <ul style="list-style-type: none">• NC programming• PLC programming• TNC optimization• TNC service• Encoder service• Special training for specific customers <p>For more information on dates, registration, etc. call in Germany: +49 8669 31-2293 or 31-1695 +49 8669 31-1999 E-mail: mtt@heidenhain.de www.heidenhain.de</p>

Other HEIDENHAIN controls

Examples

TNC 128

Information: *TNC 128 brochure*

- Straight cut control for **milling, drilling and boring machines**
- Up to 5 axes and open-loop main spindle
- Analog command interface to the drives (± 10 V)
- Compact design: Screen, keyboard and main computer all in one unit
- Dimensions: 400 mm x 450 mm x 91 mm
- Integral 12.1-inch TFT color flat-panel display
- Storage medium for NC programs: CompactFlash memory card
- Programming in HEIDENHAIN conversational format
- Standard milling, drilling and boring cycles
- Touch probe cycles
- Short block processing time



TNC 620

Information:
TNC 620 brochure

- Compact contouring control for **milling, drilling and boring machines**
- Up to 5 axes and closed-loop main spindle
- HEIDENHAIN inverter systems and motors recommended
- Uniformly digital with HSCI interface and EnDat interface
- Compact design:
 - Screen, keyboard and main computer housed in one unit (MC 7410)
 - Screen and main computer housed in one unit (MC 7420) and separate keyboard with integrated ASCII keys
- Dimensions: 400 mm x 470 mm x 100 mm (MC 7410)
- Integrated 15-inch TFT color flat-panel display
- Storage medium for NC programs: CompactFlash memory card
- Programming in HEIDENHAIN conversational format or according to DIN/ISO
- Standard milling, drilling and boring cycles
- Touch probe cycles
- Short block processing time (1.5 ms)



TNC 640

Information:
TNC 640 brochure

- Contouring control for **milling/turning machines and machining centers**
- Up to 18 axes and closed-loop main spindle
- HEIDENHAIN inverter systems and motors recommended
- Uniformly digital with HSCI interface and EnDat interface
- TFT color flat-panel display, 19-inch or 15-inch
- Storage medium: HDR hard disk with 160 GB or SSDR solid state disk with 32 GB
- Programming in HEIDENHAIN conversational format or according to DIN/ISO
- Comprehensive cycle package for milling and turning operations
- Constant surface speed for turning operations
- Tool-tip radius compensation
- Touch probe cycles
- FK free contour programming
- Special function for fast 3-D machining
- Short block processing time (0.5 ms)

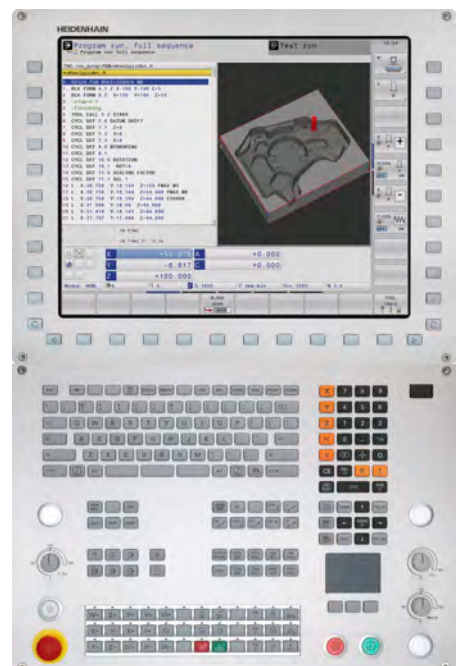

Subject index

5

5-axis machining..... 56

A

Absolute encoders..... 59
 Accessories..... 5, 50
 Active Chatter Control..... 63
 Active Vibration Damping..... 69
 Adaptive Feed Control (AFC)..... 63
 Additional modules..... 34
 Axes..... 55
 Axis clamping..... 61
 Axis feedback control..... 60

B

Backlash..... 66
 Basic modules..... 29
 BF 750..... 27, 94
 BF 760..... 28, 91
 Bus diagnosis..... 72

C

Cable overview..... 44
 Calibration sphere..... 67
 CC 6106..... 22, 86
 CC 6108..... 22
 CC 6108, CC 6110..... 87
 CC 6110..... 22
 CC 61xx..... 22
 CMA-H 04-04-00..... 34
 Color flat-panel display..... 27
 Commissioning and diagnostic aids..... 71
 Compensation of torque ripples..... 60
 Components..... 4
 Connecting cables..... 38
 Context-sensitive help..... 65
 Controller unit..... 21
 Control loop cycle times..... 61
 Crossover Position Filter (CPF)..... 70
 Cross Talk Compensation (CTC)..... 68
 Cycle times..... 21
 Cylindrical surface interpolation 55

D

Data interfaces..... 78
 Degrees of protection..... 82
 Diagnostic function..... 71
 Digital control design..... 51
 Digital servo control..... 60
 Display step..... 6
 DNC applications..... 80
 Double speed..... 21
 Double-speed control loops..... 61
 DriveDiag..... 71
 Dynamic Collision Monitoring..... 64
 Dynamic Efficiency..... 62
 Dynamic Precision..... 68

E

Electromagnetic compatibility..... 82
 Electronic handwheels..... 37
 Empty housing..... 30, 31
 Encoder inputs..... 59
 Encryption of PLC data..... 73
 EnDat 2.2..... 51
 Error compensation..... 66
 Ethernet..... 78
 Expansion PL..... 29
 Export version..... 15

F

Fast contour milling..... 62
 Feature content level (FCL)..... 18
 Feedforward control..... 60
 Following error..... 60
 Functional safety..... 52

G

Gantry axes..... 56
 Gear ranges..... 58

H

Handwheel selection switch..... 39
 HEROS 5..... 54
 HR 130..... 39, 103
 HR 150..... 39, 103
 HR 410..... 37, 100
 HR 410 FS..... 37
 HR 520..... 37, 101
 HR 520 FS..... 37
 HR 550 FS..... 38, 102
 HRA 110..... 39, 104
 HRA 551 FS..... 38, 102
 HSCI..... 51
 HSCI adapter..... 33
 HSCI control components..... 15
 Hysteresis..... 66

I

I/O modules..... 30, 31
 Incremental encoders..... 59
 Industrial PC..... 40
 Input resolution..... 6
 Integrated inverter..... 60
 Integrated PLC..... 73
 Inverter system..... 49
 IOconfig..... 30, 31
 IPC 6641..... 40, 83
 ITC 750..... 40, 94
 ITC 755..... 40, 90
 ITC 760..... 40, 91

J

Jerk..... 61

Jerk limiting..... 61

K

KinematicsComp..... 67
 KinematicsDesign..... 65

L

Linear axes..... 55
 Linear error..... 66
 Load Adaptive Control (LAC) 69
 Log..... 72
 Logic diagram..... 72
 Look-ahead..... 62

M

Machine interfacing..... 8
 Machine operating panel..... 27
 Main computer..... 15
 Master keyword..... 17
 Maximum spindle speed..... 58
 MB 720..... 27, 97
 MB 720 FS..... 27
 MC 6441..... 16, 83
 MC 6541..... 16, 83
 MC 6542..... 16, 84
 MC 6641..... 16, 83
 MC 7422..... 16, 85
 MC 7522..... 16, 85
 Memory medium..... 17
 Milling-head change..... 58
 Module for analog axes..... 34
 Module for PROFIBUS-DP..... 34
 Monitoring functions..... 64
 Motion Adaptive Control (MAC)..... 70
 Mounting and electrical installation..... 82

N

NC software license..... 19
 Nonlinear error..... 66

O

Operating system..... 54
 Options..... 13
 Oriented spindle stop..... 58
 Oscilloscope..... 72

P

PL 550..... 31
 PL 6000..... 29, 98
 PLA 4-4..... 31
 PLA-H 08-04-04..... 30
 PLB 550..... 31
 PLB 6001..... 33, 97
 PLB 6104..... 29
 PLB 6104 FS..... 29
 PLB 6106..... 29

PLB 6106 FS.....	29
PLB 6108.....	29
PLB 6108 FS.....	29
PLB 6204.....	29
PLB 6204 FS.....	29
PLB 6206.....	29
PLB 6206 FS.....	29
PLB 6208.....	29
PLB 6208 FS.....	29
PLC axes.....	57, 74
PLC basic program.....	76
PLCdesign	75
PLC inputs/outputs.....	73
PLC positioning.....	74
PLC programming.....	73
PLC soft keys.....	74
PLC window.....	74
PLD 16-8.....	31
PLD-H 04-08-00 FS.....	30
PLD-H 08-04-00 FS.....	30
PLD-H 08-16-00.....	30
PLD-H 16-08-00.....	30
Position Adaptive Control (PAC).....	69
Position-controlled spindle.....	58
Power supply.....	32
Proper minimum clearance.....	81
PSL 130.....	32, 99
PSL 135.....	32, 99
Python OEM Process	75

R

Remote Desktop Manager.....	79
RemoTools SDK.....	80
Reversal spikes.....	66
Ribbon cable.....	23
Rotary axes.....	55
RS-232-C.....	78

S

Screen	27
Second spindle.....	58
SIK component.....	17
Single speed	21
Sliding friction.....	66
Smoothed jerk.....	61
Snap-on keys.....	41, 42
Software.....	5
Specifications.....	6
Spindle.....	58
Spindle override.....	58
Spline interpolation.....	62
Static friction.....	66
Synchronized axes.....	56
System PL.....	29

T

Table function.....	72
Tapping.....	58
TE 720.....	27
TE 730	27, 27

TE 735.....	27, 96
TE 735 FS.....	27
TE 740.....	28, 92
TE 745.....	28, 93
TE 745 FS.....	28
TeleService	72
Thermal expansion.....	66
Tilting the working plane.....	56
TNCkeygen.....	18
TNCopt	71
TNCremo	79
TNCremoPlus	79
TNCscope	72
Tool measurement.....	36
Torque.....	57
Torque control.....	57
Touch probes.....	35
Trace function.....	72

U

UEC 111.....	25, 88
UEC 112.....	25, 88
UEC 113.....	25, 88
UEC 11x.....	24
UMC 111.....	26, 89
UMC 11x.....	26
USB.....	78
USB hub.....	79, 105

V

virtualTNC.....	80
Voltage supply.....	15

W

Workpiece measurement.....	35
----------------------------	----

HEIDENHAIN

DR. JOHANNES HEIDENHAIN GmbH

Dr.-Johannes-Heidenhain-Straße 5

83301 Traunreut, Germany

☎ +49 8669 31-0

FAX +49 8669 5061

E-mail: info@heidenhain.de

www.heidenhain.de

Vollständige und weitere Adressen siehe www.heidenhain.de
For complete and further addresses see www.heidenhain.de

DE	HEIDENHAIN Vertrieb Deutschland 83301 Traunreut, Deutschland ☎ 08669 31-3132 FAX 08669 32-3132 E-Mail: hd@heidenhain.de	ES	FARRESA ELECTRONICA S.A. 08028 Barcelona, Spain www.farresa.es	PL	APS 02-384 Warszawa, Poland www.heidenhain.pl
	HEIDENHAIN Technisches Büro Nord 12681 Berlin, Deutschland ☎ 030 54705-240	FI	HEIDENHAIN Scandinavia AB 02770 Espoo, Finland www.heidenhain.fi	PT	FARRESA ELECTRÓNICA, LDA. 4470 - 177 Maia, Portugal www.farresa.pt
	HEIDENHAIN Technisches Büro Mitte 07751 Jena, Deutschland ☎ 03641 4728-250	FR	HEIDENHAIN FRANCE sarl 92310 Sèvres, France www.heidenhain.fr	RO	HEIDENHAIN Reprezentantă Romania Braşov, 500407, Romania www.heidenhain.ro
	HEIDENHAIN Technisches Büro West 44379 Dortmund, Deutschland ☎ 0231 618083-0	GB	HEIDENHAIN (G.B.) Limited Burgess Hill RH15 9RD, United Kingdom www.heidenhain.co.uk	RS	Serbia → BG
	HEIDENHAIN Technisches Büro Südwest 70771 Leinfelden-Echterdingen, Deutschland ☎ 0711 993395-0	GR	MB Milionis Vassilis 17341 Athens, Greece www.heidenhain.gr	RU	OOO HEIDENHAIN 115172 Moscow, Russia www.heidenhain.ru
	HEIDENHAIN Technisches Büro Südost 83301 Traunreut, Deutschland ☎ 08669 31-1345	HK	HEIDENHAIN LTD Kowloon, Hong Kong E-mail: sales@heidenhain.com.hk	SE	HEIDENHAIN Scandinavia AB 12739 Skärholmen, Sweden www.heidenhain.se
		HR	Croatia → SL	SG	HEIDENHAIN PACIFIC PTE LTD. Singapore 408593 www.heidenhain.com.sg
AR	NAKASE SRL. B1653AOX Villa Ballester, Argentina www.heidenhain.com.ar	HU	HEIDENHAIN Kereskedelmi Képviselet 1239 Budapest, Hungary www.heidenhain.hu	SK	KOPRETINA TN s.r.o. 91101 Trenčín, Slovakia www.kopretina.sk
AT	HEIDENHAIN Techn. Büro Österreich 83301 Traunreut, Germany www.heidenhain.de	ID	PT Servitama Era Toolsindo Jakarta 13930, Indonesia E-mail: ptset@group.gts.co.id	SL	NAVO d.o.o. 2000 Maribor, Slovenia www.heidenhain.si
AU	FCR Motion Technology Pty. Ltd Laverton North 3026, Australia E-mail: vicsales@fcrmotion.com	IL	NEUMO VARGUS MARKETING LTD. Tel Aviv 61570, Israel E-mail: neumo@neumo-vargus.co.il	TH	HEIDENHAIN (THAILAND) LTD Bangkok 10250, Thailand www.heidenhain.co.th
BE	HEIDENHAIN NV/SA 1760 Roosdaal, Belgium www.heidenhain.be	IN	HEIDENHAIN Optics & Electronics India Private Limited Chetpet, Chennai 600 031, India www.heidenhain.in	TR	T&M Mühendislik San. ve Tic. LTD. ŞTİ. 34728 Ümraniye-Istanbul, Turkey www.heidenhain.com.tr
BG	ESD Bulgaria Ltd. Sofia 1172, Bulgaria www.esd.bg	IT	HEIDENHAIN ITALIANA S.r.l. 20128 Milano, Italy www.heidenhain.it	TW	HEIDENHAIN Co., Ltd. Taichung 40768, Taiwan R.O.C. www.heidenhain.com.tw
BR	DIADUR Indústria e Comércio Ltda. 04763-070 – São Paulo – SP, Brazil www.heidenhain.com.br	JP	HEIDENHAIN K.K. Tokyo 102-0083, Japan www.heidenhain.co.jp	UA	Gertner Service GmbH Büro Kiev 01133 Kiev, Ukraine www.heidenhain.ua
BY	GERTNER Service GmbH 220026 Minsk, Belarus www.heidenhain.by	KR	HEIDENHAIN Korea LTD. Gasan-Dong, Seoul, Korea 153-782 www.heidenhain.co.kr	US	HEIDENHAIN CORPORATION Schaumburg, IL 60173-5337, USA www.heidenhain.com
CA	HEIDENHAIN CORPORATION Mississauga, Ontario L5T2N2, Canada www.heidenhain.com	MX	HEIDENHAIN CORPORATION MEXICO 20290 Aguascalientes, AGS., Mexico E-mail: info@heidenhain.com	VE	Maquinaria Diekmann S.A. Caracas, 1040-A, Venezuela E-mail: purchase@diekmann.com.ve
CH	HEIDENHAIN (SCHWEIZ) AG 8603 Schwerzenbach, Switzerland www.heidenhain.ch	MY	ISOSERVE SDN. BHD. 43200 Balakong, Selangor E-mail: isoserve@po.jaring.my	VN	AMS Co. Ltd HCM City, Vietnam E-mail: davidgoh@amsvn.com
CN	DR. JOHANNES HEIDENHAIN (CHINA) Co., Ltd. Beijing 101312, China www.heidenhain.com.cn	NL	HEIDENHAIN NEDERLAND B.V. 6716 BM Ede, Netherlands www.heidenhain.nl	ZA	MAFEMA SALES SERVICES C.C. Midrand 1685, South Africa www.heidenhain.co.za
CZ	HEIDENHAIN s.r.o. 102 00 Praha 10, Czech Republic www.heidenhain.cz	NO	HEIDENHAIN Scandinavia AB 7300 Orkanger, Norway www.heidenhain.no		
DK	TPTEKNIK A/S 2670 Greve, Denmark www.tp-gruppen.dk	PH	Machinebanks Corporation Quezon City, Philippines 1113 E-mail: info@machinebanks.com		

