

Data sheet | Item number: 773-104

PUSH WIRE® connector for junction boxes; for solid and stranded conductors; max. 2.5 mm²; 4-conductor; transparent housing; orange cover; Surrounding air temperature: max 60°C; 2,50 mm²

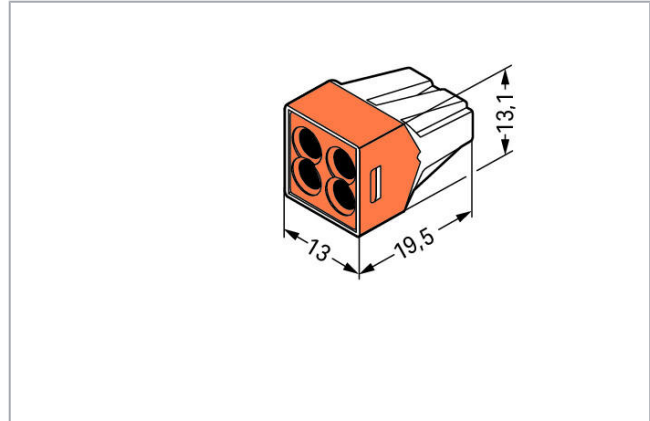

www.wago.com/773-104

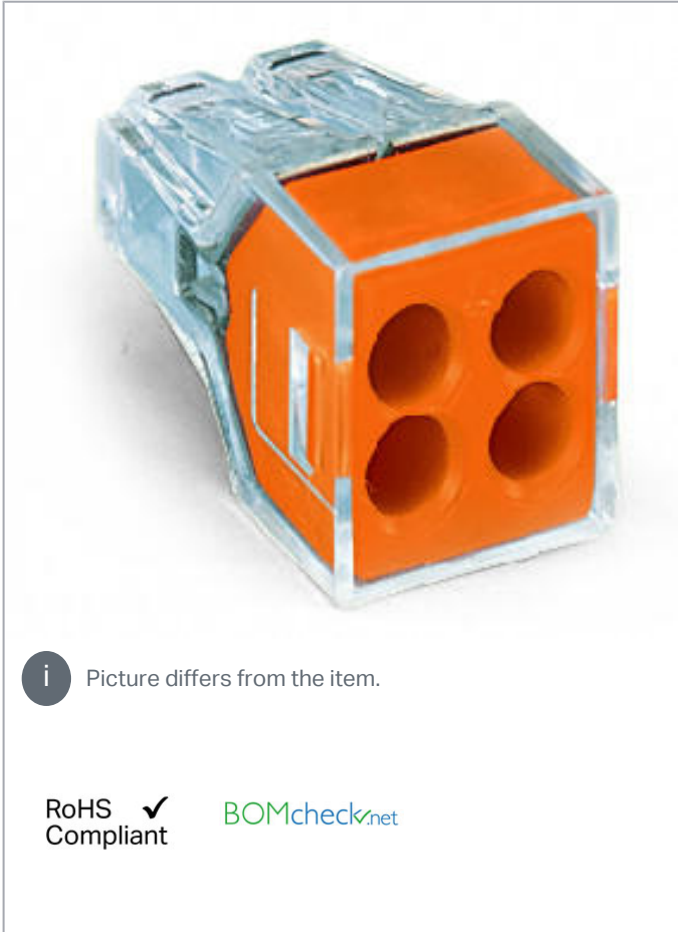

i Picture differs from the item.

RoHS Compliant

Item description

Note:

Terminating Aluminum Conductors

WAGO spring clamp terminal blocks are suitable for solid aluminum conductors up to 4 mm²/12 AWG if WAGO "Alu-Plus" Contact Paste is used for termination.

"Alu-Plus" Contact Paste Advantages:

- Automatically destroys the oxide film during clamping.
- Prevents fresh oxidation at the clamping point.
- Prevents electrolytic corrosion between aluminum and copper conductors (in the same terminal block).

—
Subject to changes. Please also observe the further product documentation!

WAGO Kontakttechnik GmbH & Co. KG
Hansastr. 27
32423 Minden
Phone: +49571 887-0 | Fax: +49571 887-169
Email: info.de@wago.com | Web: www.wago.com

Do you have any questions about our products?
We are always happy to take your call at 01788 568 008.



- Provides long-term protection against corrosion.

For spring clamp connections with PUSH WIRE® connection technology, **WAGO recommends that the aluminum conductor first be cleaned and then immediately inserted into the clamping unit filled with "Alu-Plus" contact paste.**

It is also possible to apply WAGO "Alu-Plus" **additionally** on the whole surface of the aluminum conductor before termination.

Please note that the nominal currents must be adapted to the reduced conductivity of the aluminum conductors::

2.5 mm² = 16 A

4 mm² = 22 A

Safety information 1:

in grounded power lines

Safety information 2:

When using conductors of exclusively the same cross-section, 0.75 mm²/18 AWG is also possible.

Data

Electrical data

Ratings per IEC/EN 60664-1

Ratings per	IEC/EN 60664-1
Nominal voltage (II/2)	400 V
Rated surge voltage (II/2)	4 kV
Rated current	24 A
Legend (ratings)	(II / 2) ≙ Overvoltage category II / Pollution degree 2

Connection data

Connection technology	PUSH WIRE®
Actuation type	Push-in
Connectable conductor materials	Copper Aluminum
Solid conductor	0.75 ... 2.5 mm ² / 18 ... 12 AWG
Stranded conductor	1.5 ... 2.5 mm ² / 16 ... 12 AWG
Strip length	12 mm / 0.47 inch
Total number of connection points	4
Total number of potentials	1
Wiring type	Side-entry wiring

Subject to changes. Please also observe the further product documentation!

Physical data

Width	13 mm / 0.512 inch
Height	13.1 mm / 0.516 inch
Depth	19.5 mm / 0.768 inch

Material Data

Cover color	orange
Flammability class per UL94	V2
Fire load	0.056 MJ
Weight	2.5 g

Environmental Requirements



Surrounding air temperature (operation)	60 ... 60 °C
---	--------------

Commercial data

Product Group	7 (Push Wire Conn.)
Packaging type	BOX
Country of origin	CN
GTIN	4044918397629
Customs tariff number	85369010000

Approvals / Certificates

Country specific Approvals





Logo	Approval	Additional Approval Text	Certificate name
	CCA UL International Demko A/S	EN 60998	CCA-DK No. 2520
	CSA DEKRA Certification B.V.	C22.2	15411 (LR46759)
	ÖVE Österreichischer Verband für Elektrotechnik	EN 60998	1193-031- 09

Subject to changes. Please also observe the further product documentation!



WAGO Kontakttechnik GmbH & Co. KG
Hansastr. 27
32423 Minden
Phone: +49571 887-0 | Fax: +49571 887-169
Email: info.de@wago.com | Web: www.wago.com

Do you have any questions about our products?
We are always happy to take your call at 01788 568 008.

Ship Approvals

Logo	Approval	Additional Approval Text	Certificate name
	ABS American Bureau of Shipping	-	18- HG1755093- PDA
	BV Bureau Veritas S.A.	EN 60998	11914/C0 BV
	DNV GL Det Norske Veritas, Germanischer Lloyd	EN 60998	TAE000015T
	LR Lloyds Register	EN 60998	04/20013 (E8)

UL-Approvals

Logo	Approval	Additional Approval Text	Certificate name
	UL UL International Germany GmbH	UL 486C	E69654
	UL UL International Germany GmbH	EN 60998	D-03479- A1

Counterpart

Compatible products

General accessories

 **Item no.: 249-130**
Syringe; Contents: 20 ml Alu-Plus contact paste

www.wago.com/249-130

Subject to changes. Please also observe the further product documentation!

WAGO Kontakttechnik GmbH & Co. KG
Hansastr. 27
32423 Minden
Phone: +49571 887-0 | Fax: +49571 887-169
Email: info.de@wago.com | Web: www.wago.com

Do you have any questions about our products?
We are always happy to take your call at 01788 568 008.

Mounting adapter



Item no.: 773-332

Mounting carrier; 773 Series - 2.5 mm² / 4 mm² / 6 mm²; for DIN-35 rail mounting/screw mounting; orange

www.wago.com/773-332

Downloads

Documentation

Additional Information

Technical explanations	03-Apr-2019	pdf 2.1 MB	Download
------------------------	-------------	---------------	----------

CAD/CAE-Data

CAE data

WSCAD Universe 773-104	URL	Download
------------------------	-----	----------

Installation Notes

Subject to changes. Please also observe the further product documentation!