

# WEU26/2-213

WSU/WEU26/2

**SINGLE-BEAM PHOTOELECTRIC SAFETY SWITCHES**

**SICK**  
Sensor Intelligence.

Ordering information

Type	Part no.
WEU26/2-213	1015748

Other models and accessories → [www.sick.com/WSU\\_WEU26\\_2](http://www.sick.com/WSU_WEU26_2)



Detailed technical data

Safety-related parameters

<b>Type</b>	EN 61496 part 1 and EN 50100 part 2
-------------	-------------------------------------

Features

<b>Number of beams</b>	1
<b>Response time</b>	≤ 22 ms
<b>Front screen heating</b>	✓
<b>Synchronization</b>	Optical, without separate synchronization cable

Interfaces

<b>Connection type</b>	Plug 6 + PE
<b>Diagnostic display</b>	LED
<b>Fieldbus, industrial network</b> Integration via Flexi Soft safety controller	CANopen, DeviceNet™, EtherCAT®, EtherNet/IP™, Modbus TCP, PROFIBUS DP, PROFINET <sup>1)</sup>

<sup>1)</sup> For further information on Flexi Soft, please see sens:Control – safe control solutions product catalog or -> [www.sick.com/FlexiSoft](http://www.sick.com/FlexiSoft).

Electrical data

<b>Switching outputs</b>	Switching outputs
<b>Switching current</b>	0.02 A ... 2 A
<b>Electrical life (relay contacts)</b>	5 x 10 <sup>4</sup> switching cycles

Ambient data

<b>Enclosure rating</b>	IP65
<b>Ambient operating temperature</b>	-25 °C ... +55 °C
<b>Storage temperature</b>	-25 °C ... +70 °C
<b>Air humidity</b>	15 % ... 95 %, Non-condensing
<b>Vibration resistance</b>	5 g, 10 Hz ... 55 Hz (IEC 68-2-6)
<b>Shock resistance</b>	10 g (according to IEC 68-2-29)

Classifications

<b>ECl@ss 5.0</b>	27272701
<b>ECl@ss 5.1.4</b>	27272701
<b>ECl@ss 6.0</b>	27272701
<b>ECl@ss 6.2</b>	27272701
<b>ECl@ss 7.0</b>	27272701
<b>ECl@ss 8.0</b>	27272701

<b>ECI@ss 8.1</b>	27272701
<b>ECI@ss 9.0</b>	27272701
<b>ETIM 5.0</b>	EC001831
<b>ETIM 6.0</b>	EC001831
<b>UNSPSC 16.0901</b>	46171620

**Dimensional drawing** (Dimensions in mm (inch))

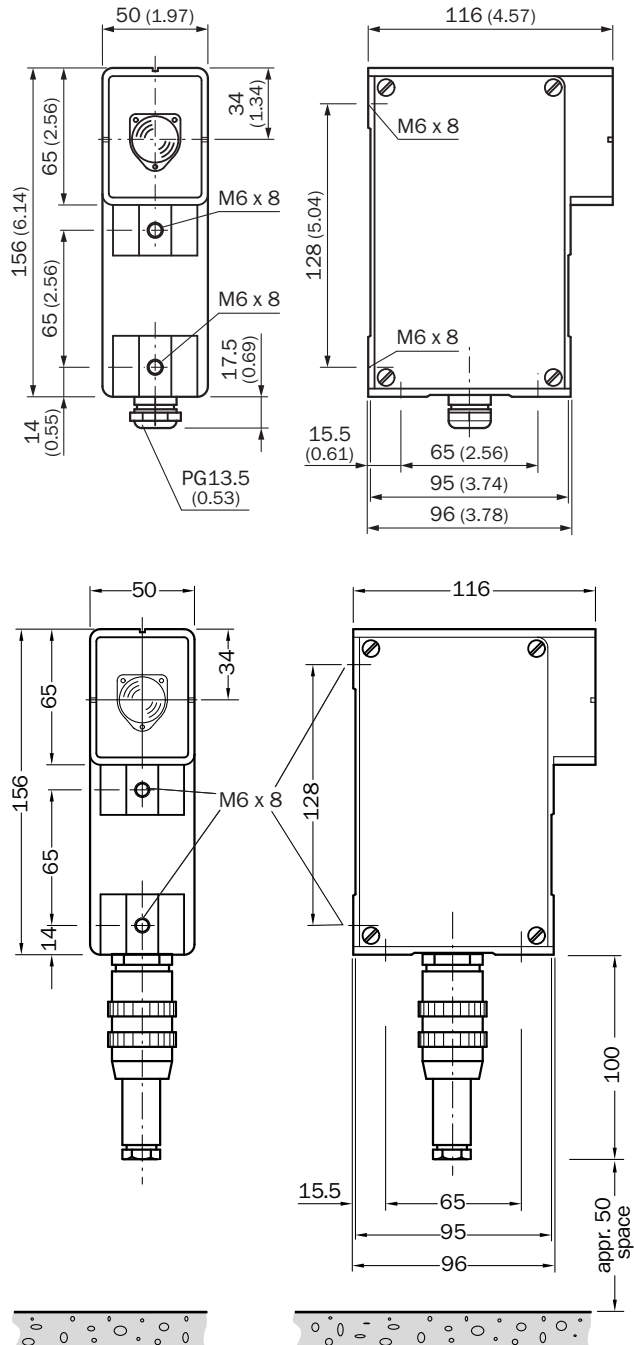

# WEU26/2-213 | WSU/WEU26/2

## SINGLE-BEAM PHOTOELECTRIC SAFETY SWITCHES



## SICK AT A GLANCE

SICK is one of the leading manufacturers of intelligent sensors and sensor solutions for industrial applications. A unique range of products and services creates the perfect basis for controlling processes securely and efficiently, protecting individuals from accidents and preventing damage to the environment.

We have extensive experience in a wide range of industries and understand their processes and requirements. With intelligent sensors, we can deliver exactly what our customers need. In application centers in Europe, Asia and North America, system solutions are tested and optimized in accordance with customer specifications. All this makes us a reliable supplier and development partner.

Comprehensive services complete our offering: SICK LifeTime Services provide support throughout the machine life cycle and ensure safety and productivity.

For us, that is “Sensor Intelligence.”

## WORLDWIDE PRESENCE:

Contacts and other locations –[www.sick.com](http://www.sick.com)