



# General purpose relays 7 - 10 A



Automation for  
blinds, grilles  
and shutters



Control and  
management of  
electric power



Shipyards



Road / tunnel  
lighting



Hoists and  
cranes



Circuit breakers  
and switches



Control panels



Panels for electrical  
distribution

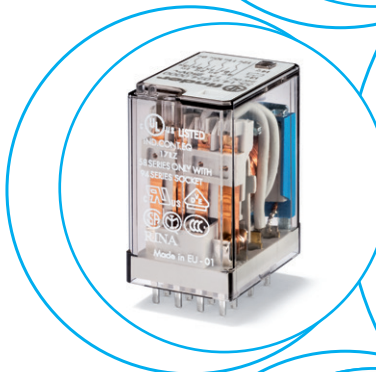



**General purpose relays**  
**For printed circuit mounting**

**Type 55.12**

- 2 CO 10 A

**Type 55.13**

- 3 CO 10 A

**Type 55.14**

- 4 CO 7 A

- AC & DC coils
- Cadmium Free contacts
- Contact material options
- RT III (wash tight) option available



- 2 CO 10 A
- PCB mount



- 3 CO 10 A
- PCB mount



- 4 CO 7 A
- PCB mount

FOR UL RATINGS SEE:  
"General technical information" page V

For outline drawing see page 6

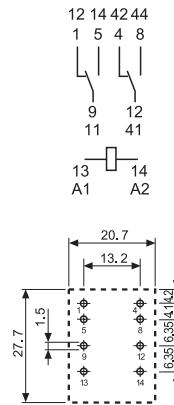

Copper side view

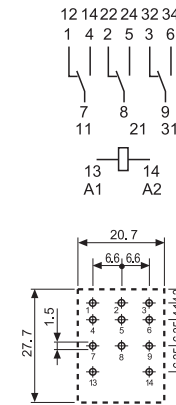

Copper side view

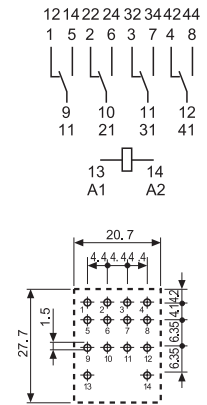

Copper side view

**Contact specification**

Contact configuration		2 CO (DPDT)	3 CO (3PDT)	4 CO (4PDT)
Rated current/Maximum peak current	A	10/20	10/20	7/15
Rated voltage/ Maximum switching voltage	V AC	250/400	250/400	250/250
Rated load AC1	VA	2500	2500	1750
Rated load AC15 (230 V AC)	VA	500	500	350
Single phase motor rating (230 V AC)	kW	0.37	0.37	0.125
Breaking capacity DC1: 30/110/220 V	A	10/0.25/0.12	10/0.25/0.12	7/0.25/0.12
Minimum switching load	mW (V/mA)	300 (5/5)	300 (5/5)	300 (5/5)
Standard contact material		AgNi	AgNi	AgNi

**Coil specification**

Nominal voltage (U <sub>N</sub> )	V AC (50/60 Hz)	6 - 12 - 24 - 48 - 60 - 110 - 120 - 230 - 240		
	V DC	6 - 12 - 24 - 48 - 60 - 110 - 125 - 220		
Rated power AC/DC	VA (50 Hz)/W	1.5/1	1.5/1	1.5/1
Operating range	AC	(0.8...1.1)U <sub>N</sub>		
	DC	(0.8...1.1)U <sub>N</sub>		
Holding voltage	AC/DC	0.8 U <sub>N</sub> / 0.5 U <sub>N</sub>		
Must drop-out voltage	AC/DC	0.2 U <sub>N</sub> / 0.1 U <sub>N</sub>		

**Technical data**

Mechanical life AC/DC	cycles	20 · 10 <sup>6</sup> / 50 · 10 <sup>6</sup>	20 · 10 <sup>6</sup> / 50 · 10 <sup>6</sup>	20 · 10 <sup>6</sup> / 50 · 10 <sup>6</sup>
Electrical life at rated load AC1	cycles	200 · 10 <sup>3</sup>	200 · 10 <sup>3</sup>	150 · 10 <sup>3</sup>
Operate/release time	ms	10/5	10/5	11/3
Insulation between coil and contacts (1.2/50 μs)	kV	4	4	4
Dielectric strength between open contacts	V AC	1000	1000	1000
Ambient temperature range	°C	-40...+85	-40...+85	-40...+85
Environmental protection		RT I	RT I	RT I

**Approvals** (according to type)



**General purpose relays**

**For socket mounting**

**Type 55.32**

- 2 CO 10 A

**Type 55.33**

- 3 CO 10 A

**Type 55.34**

- 4 CO 7 A

- AC & DC coils
- Lockable test button and mechanical flag indicator as standard on 2 & 4 pole types
- Integral LED and coil suppression options
- 94 series sockets for PCB or 35 mm rail mounting (EN 60715) with Screw, Screwless or Push-in terminals
- Coil Indication and EMC suppression modules 99 series and Timer module 86.30 options
- Optional alternative mounting adaptors
- UL Listing (certain relay/socket combinations)
- Cadmium Free contacts
- Contact material options
- European Patent

FOR UL RATINGS SEE:

"General technical information" page V

For outline drawing see page 6

**Contact specification**

Contact configuration		2 CO (DPDT)	3 CO (3PDT)	4 CO (4PDT)
Rated current/Maximum peak current	A	10/20	10/20	7/15
Rated voltage/Maximum switching voltage	V AC	250/400	250/400	250/250
Rated load AC1	VA	2500	2500	1750
Rated load AC15 (230 V AC)	VA	500	500	350
Single phase motor rating (230 V AC)	kW	0.37	0.37	0.125
Breaking capacity DC1: 30/110/220 V	A	10/0.25/0.12	10/0.25/0.12	7/0.25/0.12
Minimum switching load	mW (V/mA)	300 (5/5)	300 (5/5)	300 (5/5)
Standard contact material		AgNi	AgNi	AgNi

**Coil specification**



Nominal voltage (U <sub>N</sub> )	V AC (50/60 Hz)	6 - 12 - 24 - 48 - 60 - 110 - 120 - 230 - 240		
	V DC	6 - 12 - 24 - 48 - 60 - 110 - 125 - 220		
Rated power AC/DC	VA (50 Hz)/W	1.5/1	1.5/1	1.5/1
Operating range	AC	(0.8...1.1)U <sub>N</sub>		
	DC	(0.8...1.1)U <sub>N</sub>		
Holding voltage	AC/DC	0.8 U <sub>N</sub> / 0.5 U <sub>N</sub>		
Must drop-out voltage	AC/DC	0.2 U <sub>N</sub> / 0.1 U <sub>N</sub>		

**Technical data**

Mechanical life AC/DC	cycles	20 · 10 <sup>6</sup> / 50 · 10 <sup>6</sup>	20 · 10 <sup>6</sup> / 50 · 10 <sup>6</sup>	20 · 10 <sup>6</sup> / 50 · 10 <sup>6</sup>
Electrical life at rated load AC1	cycles	200 · 10 <sup>3</sup>	200 · 10 <sup>3</sup>	150 · 10 <sup>3</sup>
Operate/release time	ms	10/5	10/5	11/3
Insulation between coil and contacts (1.2/50 μs)	kV	4	4	4
Dielectric strength between open contacts	V AC	1000	1000	1000
Ambient temperature range	°C	-40...+85	-40...+85	-40...+85
Environmental protection		RT I	RT I	RT I

**Approvals** (according to type)

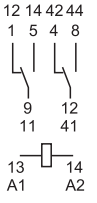
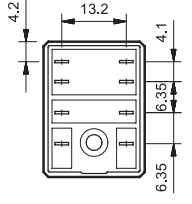
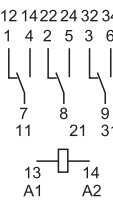
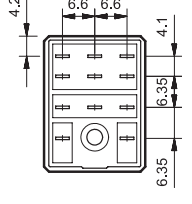
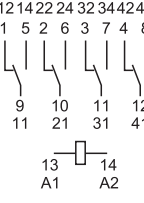
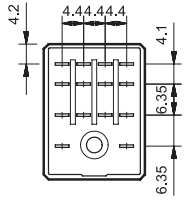

<p><b>55.32</b></p>  <ul style="list-style-type: none"> <li>• 2 CO 10 A</li> <li>• Plug-in 94 series sockets</li> </ul>	<p><b>55.33</b></p>  <ul style="list-style-type: none"> <li>• 3 CO 10 A</li> <li>• Plug-in 94 series sockets</li> </ul>	<p><b>55.34</b></p>  <ul style="list-style-type: none"> <li>• 4 CO 7 A</li> <li>• Plug-in 94 series sockets</li> </ul>
--	---	---

 	 	 
--	--	--

## Ordering information

Example: 55 series plug-in relay, 4 CO, 12 V DC coil, lockable test button and mechanical indicator.

**5 5 . 3 4 . 9 . 0 1 2 . 0 0 4 0**

**Series** ————

**Type**  
1 = PCB  
3 = Plug-in

**No. of poles**  
2 = 2 pole, 10 A  
3 = 3 pole, 10 A  
4 = 4 pole, 7 A

**Coil version**  
8 = AC (50/60 Hz)  
9 = DC

**Coil voltage**  
See coil specifications

**A: Contact material**  
0 = Standard AgNi  
5 = AgNi + Au

**B: Contact circuit**  
0 = CO (nPDT)

**D: Special versions**  
0 = Standard  
1 = Wash tight (RT III)  
for 55.12, 55.13 and 55.14 only

**C: Options**  
0 = None  
1 = Lockable test button  
2 = Mechanical indicator  
3 = LED (AC)  
4 = Lockable test button + mechanical indicator  
5 = Lockable test button + LED (AC)  
54 = Lockable test button + LED (AC) + mechanical indicator  
6\* = Double LED (DC non-polarized)  
7\* = Lockable test button + double LED (DC non-polarized)  
74\* = Lockable test button + double LED (DC non-polarized) + mechanical indicator  
8\* = LED + diode (DC, polarity positive to pin A1/13)  
9\* = Lockable test button + LED + diode (DC, polarity positive to pin A1/13)  
94\* = Lockable test button + LED + diode (DC, polarity positive to pin A1/13) + mechanical indicator  
\* Options not available for 220 V DC versions.

### Selecting features and options: only combinations in the same row are possible.

Preferred selections for best availability are shown in **bold**.

Type	Coil version	A	B	C	D
55.32/34	AC - DC	0 - 5	0	0	0
	AC	<b>0</b> - 5	<b>0</b>	2 - 3 - <b>4</b> - 5	<b>0</b>
	AC	0 - 5	0	54	/
	DC	<b>0</b> - 5	<b>0</b>	2 - <b>4</b> - 6 - 7 - 8 - 9	<b>0</b>
	DC	0 - 5	0	74 - 94	/
55.33	AC - DC	<b>0</b> - 5	<b>0</b>	<b>0</b>	<b>0</b>
	AC	0 - 5	0	1 - 3 - 5	0
	DC	0 - 5	0	1 - 6 - 7 - 8 - 9	0
55.12/13/14	AC - DC	<b>0</b> - 5	<b>0</b>	<b>0</b>	<b>0</b> - 1

### Descriptions: options and special versions

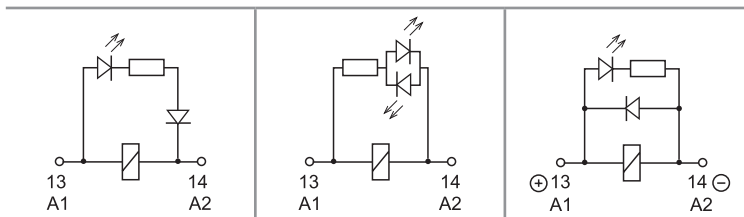

**C: Option 3, 5, 54**  
LED (AC)

**C: Option 6, 7, 74**  
Double LED  
(DC non-polarized)

**C: Option 8, 9, 94**  
LED + diode (DC, polarity positive to pin A1/13)

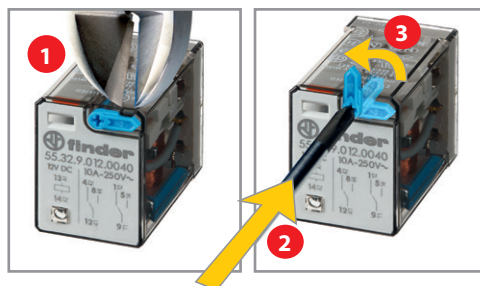

### Lockable test button and mechanical flag indicator (0010, 0040, 0050, 0054, 0070, 0074, 0090, 0094)



The dual-purpose Finder test button can be used in two ways:

Case 1) The plastic pip (located directly above the test button) remains intact. In this case, when the test button is pushed, the contacts operate. When the test button is released the contacts return to their former state.

Case 2) The plastic pip is broken-off (using an appropriate cutting tool). In this case, (in addition to the above function), when the test button is pushed and rotated, the contacts are latched in the operating state, and remain so until the test button is rotated back to its former position.

In both cases ensure that the test button actuation is swift and decisive.

### Technical data

A

Insulation according to EN 61810-1		2 pole - 3 pole	4 pole
Nominal voltage of supply system	V AC	230/400	230
Rated insulation voltage	V AC	400	250
Pollution degree		2	2
<b>Insulation between coil and contact set</b>			
Type of Insulation		Basic	Basic
Overvoltage category		III	III
Rated impulse voltage	kV (1.2/50 μs)	4	4
Dielectric strength	V AC	2000	2000
<b>Insulation between adjacent contacts</b>			
Type of insulation		Basic	Basic
Overvoltage category		III	II
Rated impulse voltage	kV (1.2/50 μs)	4	2.5
Dielectric strength	V AC	2000	2000
<b>Insulation between open contacts</b>			
Type of disconnection		Micro-disconnection	Micro-disconnection
Dielectric strength	V AC/kV (1.2/50 μs)	1000/1.5	1000/1.5
<b>Insulation between coil terminals</b>			
Rated impulse voltage (surge) differential mode (according to EN 61000-4-5)	kV(1.2/50 μs)	4	
<b>Other data</b>			
Bounce time: NO/NC	ms	1/3	
Vibration resistance (5...55)Hz: NO/NC	g	15/15	
Shock resistance	g	16	
Power lost to the environment	without contact current	W	1
	with rated current	W	3 (2 pole)      4 (3 pole)      3 (4 pole)
Recommended distance between relays mounted on PCB	mm	≥ 5	

### Contact specification

**F 55 - Electrical life (AC) v contact current**  
2 and 3 pole relays

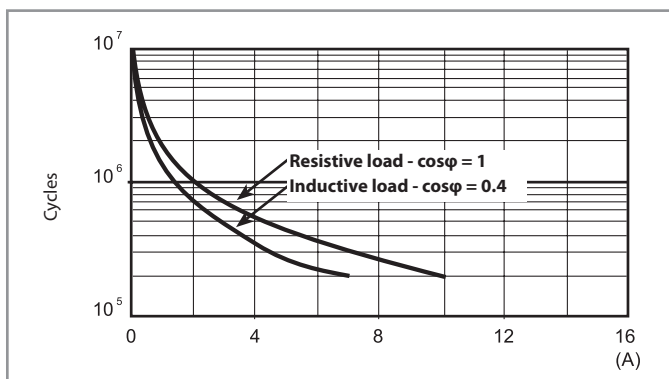

**F 55 - Electrical life (AC) v contact current**  
4 pole relays

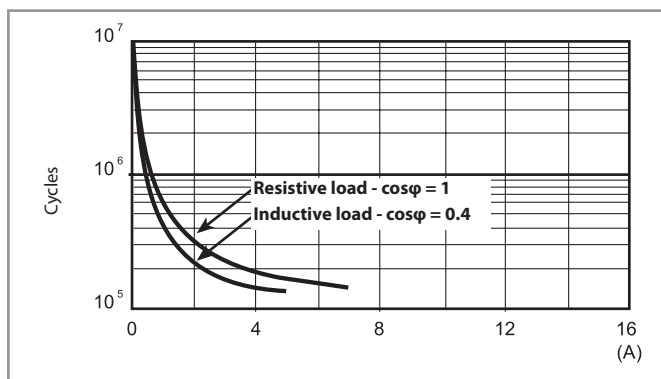

**H 55 - Maximum DC1 breaking capacity**

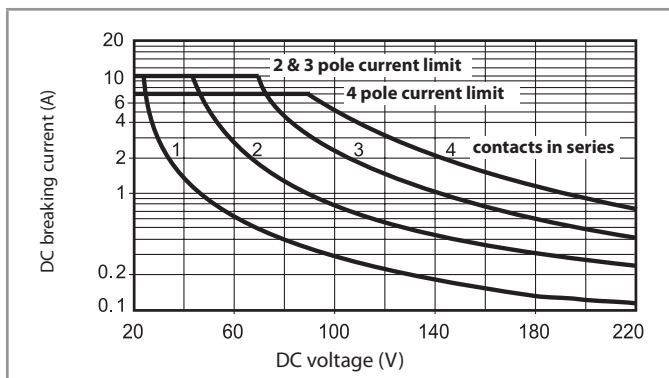

- When switching a resistive load (DC1) having voltage and current values under the curve, an electrical life of  $\geq 100 \cdot 10^3$  can be expected.
- In the case of DC13 loads, the connection of a diode in parallel with the load will permit a similar electrical life as for a DC1 load.  
Note: the release time of the load will be increased.

## Coil specifications

### DC coil data

Nominal voltage $U_N$ V	Coil code	Operating range		Resistance R $\Omega$	Rated coil consumption I at $U_N$ mA
		$U_{min}$ V	$U_{max}$ V		
6	9.006	4.8	6.6	40	150
12	9.012	9.6	13.2	140	86
24	9.024	19.2	26.4	600	40
48	9.048	38.4	52.8	2400	20
60	9.060	48	66	4000	15
110	9.110	88	121	12500	8.8
125	9.125	100	138	17300	7.2
220	9.220	176	242	54000	4

### AC coil data

Nominal voltage $U_N$ V	Coil code	Operating range		Resistance R $\Omega$	Rated coil consumption I at $U_N$ mA
		$U_{min}$ V	$U_{max}$ V		
6	8.006	4.8	6.6	12	200
12	8.012	9.6	13.2	50	97
24	8.024	19.2	26.4	190	53
48	8.048	38.4	52.8	770	25
60	8.060	48	66	1200	21
110	8.110	88	121	3940	12.5
120	8.120	96	132	4700	12
230	8.230	184	253	17000	6
240	8.240	192	264	19100	5.3

**R 55 - DC coil operating range v ambient temperature**

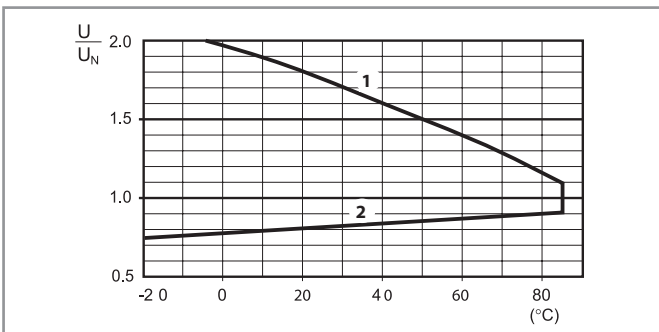

- 1 - Max. permitted coil voltage.
- 2 - Min. pick-up voltage with coil at ambient temperature.

**R 55 - AC coil operating range v ambient temperature**

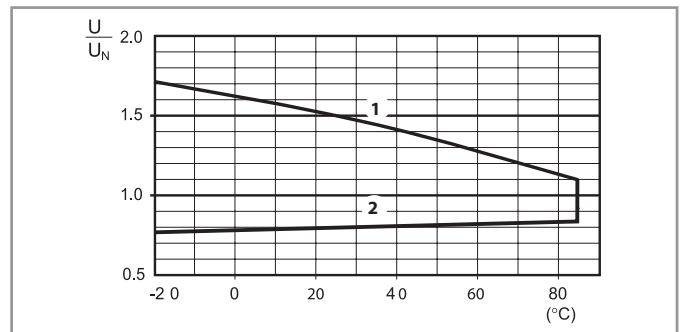

- 1 - Max. permitted coil voltage.
- 2 - Min. pick-up voltage with coil at ambient temperature.

## Outline drawings

Types 55.12/13/14

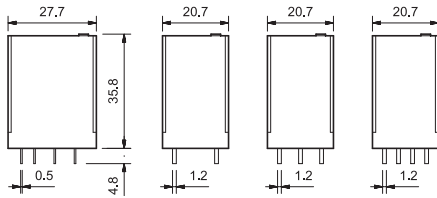

Types 55.32/33/34

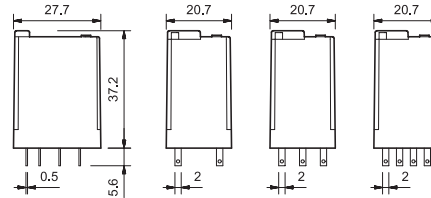

Accessories

A



056.25



056.25 with relay

Top flange mount adaptor for 55.32, 55.33, 55.34

056.25

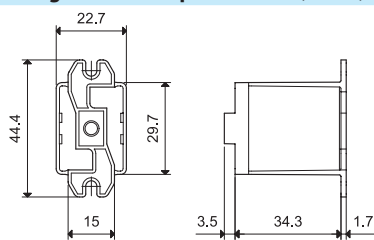

056.25

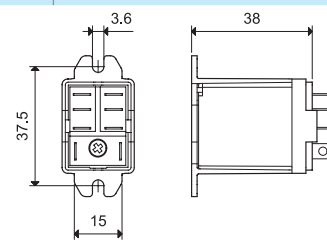

056.25 with relay



056.26



056.26 with relay

Rear flange mount adaptor for 55.32, 55.33, 55.34

056.26

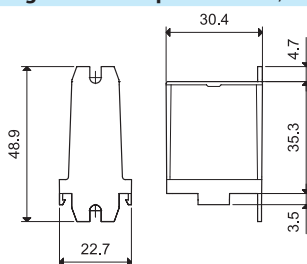

056.26

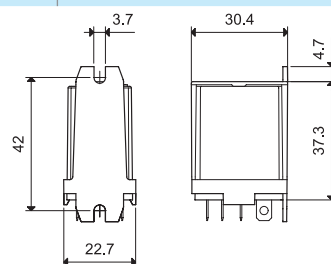

056.26 with relay



056.27



056.27 with relay

Top 35 mm rail (EN 60715) adaptor for 55.32, 55.33, 55.34

056.27

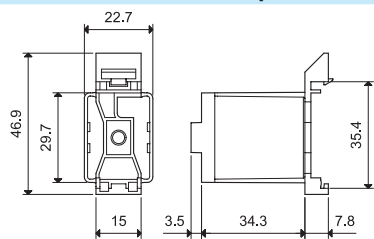

056.27

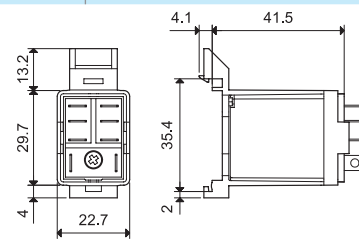

056.27 with relay



**94.P4**  
See page 10



Module	Socket	Relay	Description	Mounting	Accessories
99.02	94.P3	55.33	<b>Push-in terminal socket</b> - For fast cable connections - Top terminals - Contacts - Bottom terminals - Coil	Panel or 35 mm rail (EN 60715) mount	- Coil indication and EMC suppression modules - Jumper link - Timer modules - Plastic retaining and release clip
	94.P4	55.32 55.34			

**94.04**  
See page 12



Module	Socket	Relay	Description	Mounting	Accessories
99.02	94.02	55.32	<b>Screw terminal (Box clamp) socket</b> - Top terminals - Contacts - Bottom terminals - Coil	Panel or 35 mm rail (EN 60715) mount	- Coil indication and EMC suppression modules - Jumper link - Timer modules - Plastic retaining and release clip
	94.03	55.33			
	94.04	55.32 55.34			

**94.54**  
See page 13



Module	Socket	Relay	Description	Mounting	Accessories
99.02	94.54	55.32 55.34	<b>Screwless terminal socket</b> - Top terminals - Contacts - Bottom terminals - Coil	Panel or 35 mm rail (EN 60715) mount	- Coil indication and EMC suppression modules - Jumper link - Timer modules - Plastic retaining and release clip

**94.84.2**  
See page 14



Module	Socket	Relay	Description	Mounting	Accessories
99.80	94.84.2	55.32 55.34	<b>Screw terminal (Box clamp) socket</b>	Panel or 35 mm rail (EN 60715) mount	- Coil indication and EMC suppression modules - Jumper link - Plastic retaining and release clip

**94.94.3**  
See page 15



Module	Socket	Relay	Description	Mounting	Accessories
99.80	94.92.3	55.32	<b>Screw terminal (Box clamp) socket</b> - Top terminals - Contacts - Bottom terminals - Coil	Panel or 35 mm rail (EN 60715) mount	- Coil indication and EMC suppression modules - Jumper link - Plastic retaining and release clip
	94.94.3	55.32 55.34			

**94.74**  
See page 16



Module	Socket	Relay	Description	Mounting	Accessories
99.01	94.72	55.32	<b>Screw terminal (Plate clamp) socket</b> For 94.82: - 23 mm wide for space saving	Panel or 35 mm rail (EN 60715) mount	- Coil indication and EMC suppression modules - Plastic retaining and release clip
	94.73	55.33			
	94.74	55.32 55.34			
	94.82	55.32			

**94.14**  
See page 17

Module	Socket	Relay	Description	Mounting	Accessories
—	94.12	55.32	<b>PCB socket</b>	PCB mounting	- Metal retaining clip
—	94.13	55.33			
—	94.14	55.32 55.34			

**94.22**  
See page 17

Module	Socket	Relay	Description	Mounting	Accessories
—	94.22	55.32	<b>Panel mount with solder connections</b>	Panel mount on 1 mm thick panel	- Metal retaining clip
—	94.23	55.33			
—	94.24	55.32 55.34			

**94.34**  
See page 18

Module	Socket	Relay	Description	Mounting	Accessories
—	94.32	55.32	<b>Panel mount with solder connections</b>	M3 screw fixing	- Metal retaining clip
—	94.33	55.33			
—	94.34	55.32 55.34			

A



94.P4

Approvals  
(according to type):



UL US Certain relay/socket combinations



094.91.3

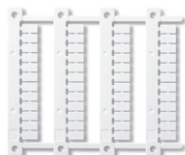

060.48

Push-in terminal socket panel or 35 mm (EN 60715) rail mount	94.P3 Blue	94.P4 Blue
For relay type	55.33	55.32, 55.34
<b>Accessories</b>		
Metal retaining clip		094.71
Plastic retaining and release clip (supplied with socket - packaging code SPA)		094.91.3
6-way jumper link		094.56
Identification tag		095.00.4
2-way jumper link		094.52.1
2-way jumper link		097.52
Marker tag holder		097.00
Modules (see table below)		99.02
Timer modules (see table below)		86.30
Sheet of marker tags for plastic retaining and release clip 094.91.3 and for marker tag holder 097.00, 48 tags, 6 x 12 mm for CEMBRE thermal transfer printers		060.48
<b>Technical data</b>		
Rated values	10 A - 250 V	
Dielectric strength	2 kV AC	
Protection category	IP 20	
Ambient temperature	°C -40...+70	
Wire strip length	mm 8	
Min. wire size for 94.P3 and 94.P4 sockets	solid wire	stranded wire
	mm <sup>2</sup> 0.5	0.5
	AWG 21	21
Max. wire size for 94.P3 and 94.P4 sockets	solid wire	stranded wire
	mm <sup>2</sup> 2 x 1.5 / 1 x 2.5	2 x 1.5 / 1 x 2.5
	AWG 2 x 16 / 1 x 14	2 x 16 / 1 x 14

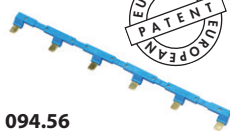
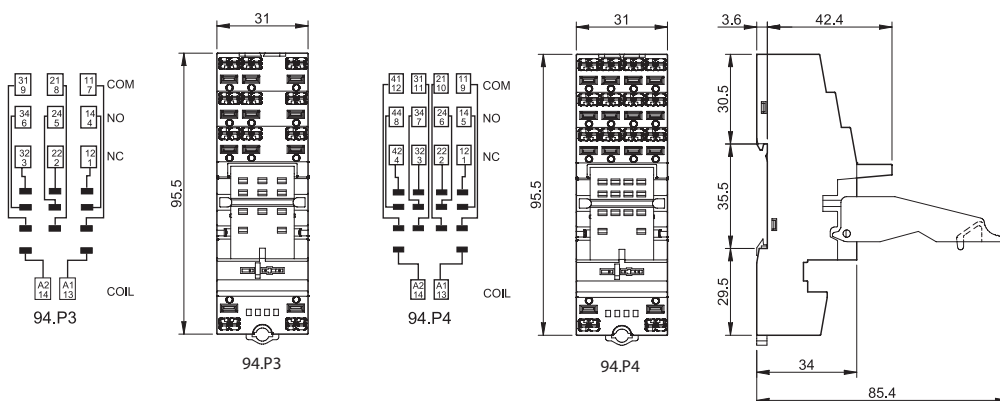

094.56

6-way jumper link for 94.P3 and 94.P4 sockets	094.56 (blue)
Rated values	10 A - 250 V

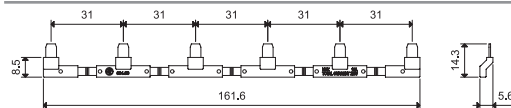

094.52.1

2-way jumper link for 94.P3 and 94.P4 sockets	094.52.1
Rated values	10 A - 250 V

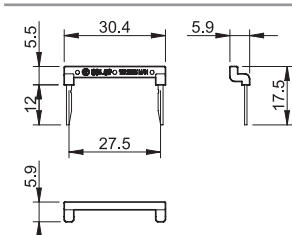



097.52

<b>2-way jumper link</b> for 94.P3 and 94.P4 sockets	097.52
Rated values	10 A - 250 V

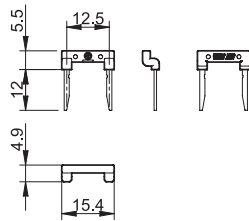

097.00

<b>Marker tag holder</b> for 94.P3 and 94.P4 sockets	097.00
--	--------

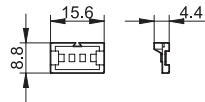

86.30

<b>86 series timer modules</b>		
(12...24)V AC/DC; Bi-function: AI, DI; (0.05 s...100 h)	86.30.0.024.0000	
(110...125)V AC; Bi-function: AI, DI; (0.05 s...100 h)	86.30.8.120.0000	
(230...240)V AC; Bi-function: AI, DI; (0.05 s...100 h)	86.30.8.240.0000	

Approvals (according to type):



99.02

Approvals  
(according to type):

DC Modules with  
non-standard polarity  
(+A2) on request.

<b>99.02 coil indication and EMC suppression modules</b> for 94.P3 and 94.P4 sockets		
Diode (+A1, standard polarity)	(6...220)V DC	99.02.3.000.00
LED	(6...24)V DC/AC	99.02.0.024.59
LED	(28...60)V DC/AC	99.02.0.060.59
LED	(110...240)V DC/AC	99.02.0.230.59
LED + Diode (+A1, standard polarity)	(6...24)V DC	99.02.9.024.99
LED + Diode (+A1, standard polarity)	(28...60)V DC	99.02.9.060.99
LED + Diode (+A1, standard polarity)	(110...220)V DC	99.02.9.220.99
LED + Varistor	(6...24)V DC/AC	99.02.0.024.98
LED + Varistor	(28...60)V DC/AC	99.02.0.060.98
LED + Varistor	(110...240)V DC/AC	99.02.0.230.98
RC circuit	(6...24)V DC/AC	99.02.0.024.09
RC circuit	(28...60)V DC/AC	99.02.0.060.09
RC circuit	(110...240)V DC/AC	99.02.0.230.09
Residual current by-pass	(110...240)V AC	99.02.8.230.07

A



94.04

Approvals  
(according to type):



cULus Certain relay/socket combinations



94.91.3

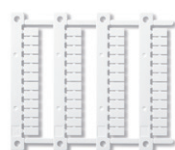

060.48

Screw terminal (Box clamp) socket panel or 35 mm (EN 60715) rail mount	94.02 Blue	94.02.0 Black	94.03 Blue	94.03.0 Black	94.04 Blue	94.04.0 Black
For relay type	55.32		55.33		55.32, 55.34	
<b>Accessories</b>						
Metal retaining clip	094.71					
Plastic retaining and release clip (supplied with socket - packaging code SPA)	094.91.3	094.91.30	094.91.3	094.91.30	094.91.3	094.91.30
6-way jumper link	094.06	094.06.0	094.06	094.06.0	094.06	094.06.0
Identification tag	094.00.4					
Marker tag holder	097.00					
Modules (see table below)	99.02					
Timer modules (see table below)	86.30					
Sheet of marker tags for plastic retaining and release clip 094.91.3 and for marker tag holder 097.00, 48 tags, 6 x 12 mm for CEMBRE thermal transfer printers	060.48					
<b>Technical data</b>						
Rated values	10 A - 250 V					
Dielectric strength	2 kV AC					
Protection category	IP 20					
Ambient temperature	°C -40...+70					
Screw torque	Nm 0.5					
Wire strip length	mm 8					
Max. wire size for 94.02/03/04 sockets	solid wire			stranded wire		
	mm <sup>2</sup> 1 x 6 / 2 x 2.5			1 x 4 / 2 x 2.5		
	AWG 1 x 10 / 2 x 14			1 x 12 / 2 x 14		

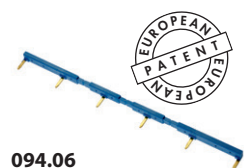
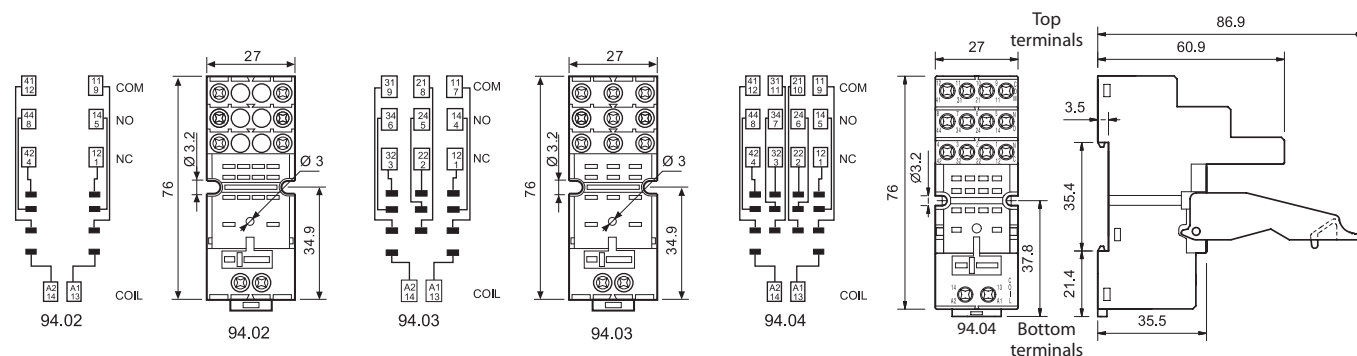

94.06

6-way jumper link for 94.02, 94.03 and 94.04 sockets	094.06 (blue)	094.06.0 (black)
Rated values	10 A - 250 V	

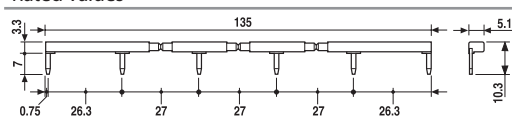

86.30

86 series timer modules	
(12...24)V AC/DC; Bi-function: AI, DI; (0.05 s...100 h)	86.30.0.024.0000
(110...125)V AC; Bi-function: AI, DI; (0.05 s...100 h)	86.30.8.120.0000
(230...240)V AC; Bi-function: AI, DI; (0.05 s...100 h)	86.30.8.240.0000

Approvals (according to type):



99.02

Approvals  
(according to type):



DC Modules with non-standard polarity (+A2) on request.

99.02 coil indication and EMC suppression modules for 94.02, 94.03 and 94.04 sockets		
Diode (+A1, standard polarity)	(6...220)V DC	99.02.3.000.00
LED	(6...24)V DC/AC	99.02.0.024.59
LED	(28...60)V DC/AC	99.02.0.060.59
LED	(110...240)V DC/AC	99.02.0.230.59
LED + Diode (+A1, standard polarity)	(6...24)V DC	99.02.9.024.99
LED + Diode (+A1, standard polarity)	(28...60)V DC	99.02.9.060.99
LED + Diode (+A1, standard polarity)	(110...220)V DC	99.02.9.220.99
LED + Varistor	(6...24)V DC/AC	99.02.0.024.98
LED + Varistor	(28...60)V DC/AC	99.02.0.060.98
LED + Varistor	(110...240)V DC/AC	99.02.0.230.98
RC circuit	(6...24)V DC/AC	99.02.0.024.09
RC circuit	(28...60)V DC/AC	99.02.0.060.09
RC circuit	(110...240)V DC/AC	99.02.0.230.09
Residual current by-pass	(110...240)V AC	99.02.8.230.07

A

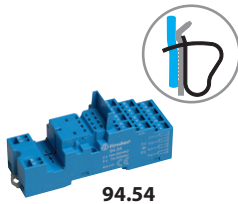

94.54

Approvals  
(according to type):



094.91.3

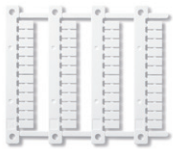

060.48

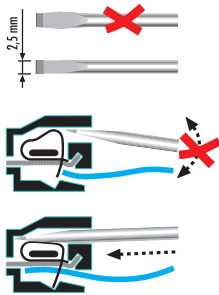

<b>Screwless terminal socket 35 mm rail (EN 60715) mount</b>		<b>94.54 (blue)</b>
For relay type		55.32, 55.34
<b>Accessories</b>		
Metal retaining clip		094.71
Plastic retaining and release clip		094.91.3
6-way jumper link		094.56
Modules (see table below)		99.02, 86.30
Sheet of marker tags for retaining and release clip 094.91.3, plastic, 48 tags, 6 x 12 mm for CEMBRE thermal transfer printers		060.48
<b>Technical data</b>		
Rated values		10 A - 250 V
Dielectric strength		2 kV AC
Protection category		IP 20
Ambient temperature		°C -25...+70
Wire strip length		mm 10
Max. wire size for 94.54 sockets		solid wire
		stranded wire
		mm <sup>2</sup> 2 x (0.5...1.5)      2 x (0.5...1.5)
		AWG 2 x (21...14)      2 x (21...14)

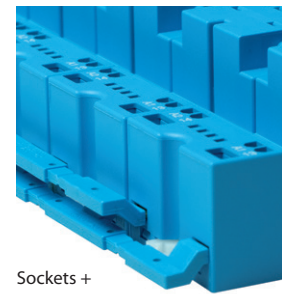
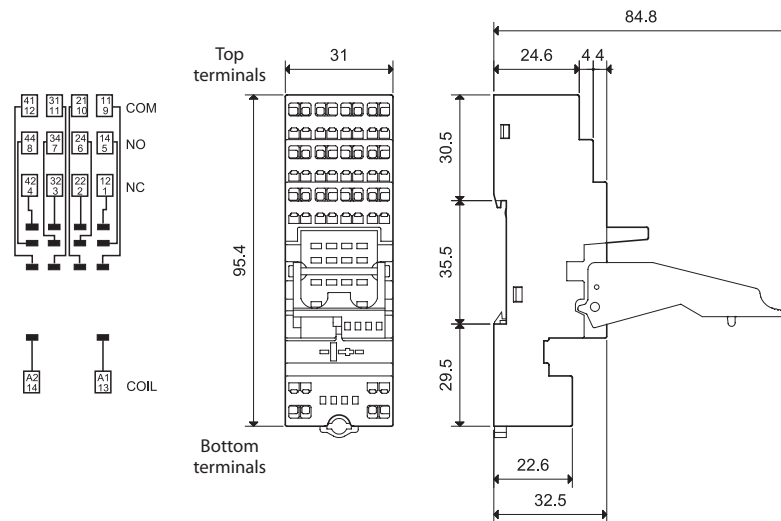

Sockets + jumper link

<b>6-way jumper link</b>	094.56 (blue)
Rated values	10 A - 250 V

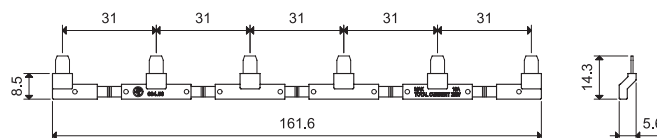

094.56



<b>86 series timer modules</b>		
(12...24)V AC/DC; Bi-function: AI, DI; (0.05 s...100 h)	86.30.0.024.0000	
(110...125)V AC; Bi-function: AI, DI; (0.05 s...100 h)	86.30.8.120.0000	
(230...240)V AC; Bi-function: AI, DI; (0.05 s...100 h)	86.30.8.240.0000	

86.30



Approvals (according to type): **CE EAC cRU US**

<b>99.02 coil indication and EMC suppression modules for 94.54 sockets</b>		
Diode (+A1, standard polarity)	(6...220)V DC	99.02.3.000.00
LED	(6...24)V DC/AC	99.02.0.024.59
LED	(28...60)V DC/AC	99.02.0.060.59
LED	(110...240)V DC/AC	99.02.0.230.59
LED + Diode (+A1, standard polarity)	(6...24)V DC	99.02.9.024.99
LED + Diode (+A1, standard polarity)	(28...60)V DC	99.02.9.060.99
LED + Diode (+A1, standard polarity)	(110...220)V DC	99.02.9.220.99
LED + Varistor	(6...24)V DC/AC	99.02.0.024.98
LED + Varistor	(28...60)V DC/AC	99.02.0.060.98
LED + Varistor	(110...240)V DC/AC	99.02.0.230.98
RC circuit	(6...24)V DC/AC	99.02.0.024.09
RC circuit	(28...60)V DC/AC	99.02.0.060.09
RC circuit	(110...240)V DC/AC	99.02.0.230.09
Residual current by-pass	(110...240)V AC	99.02.8.230.07

99.02



Approvals  
(according to type):



DC Modules with non-standard polarity (+A2) on request.

A



94.84.2

Approvals  
(according to type):



094.91.3

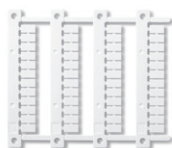

060.48



<b>Screw terminal (Box clamp) socket panel or 35 mm (EN 60715) rail mount</b>	<b>94.84.2</b>	<b>94.84.20</b>	
For relay type	55.32, 55.34		
<b>Accessories</b>			
Metal retaining clip (supplied with socket - packaging code SMA)		094.71	
Plastic retaining and release clip	094.91.3	094.91.30	
6-way jumper link	094.06	094.06.0	
Identification tag		094.80.3	
Modules (see table below)		99.80	
Sheet of marker tags for retaining and release clip 094.91.3, plastic, 48 tags, 6 x 12 mm for CEMBRE thermal transfer printers		060.48	
<b>Technical data</b>			
Rated values	10 A - 250 V		
Dielectric strength	2 kV AC		
Protection category	IP 20		
Ambient temperature	°C -40...+70		
Screw torque	Nm	0.5	
Wire strip length	mm 7		
Max. wire size for 94.84.2 socket	solid wire	stranded wire	
	mm <sup>2</sup>	1 x 6 / 2 x 2.5	1 x 4 / 2 x 2.5
	AWG	1 x 10 / 2 x 14	1 x 12 / 2 x 14

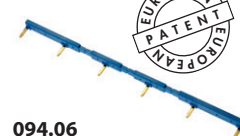
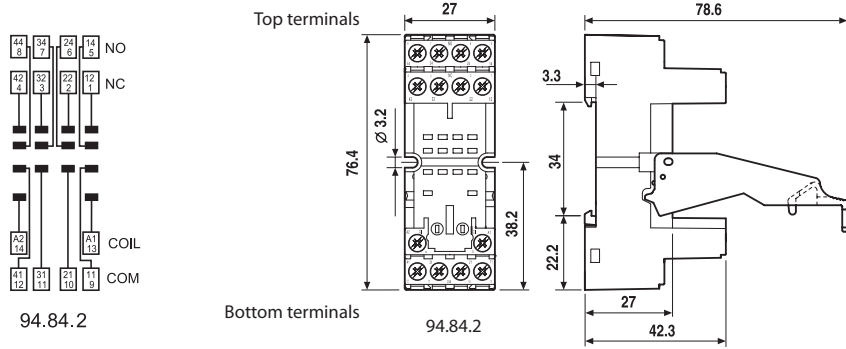

094.06



<b>6-way jumper link for 94.84.2 socket</b>	<b>094.06 (blue)</b>	<b>094.06.0 (black)</b>
Rated values	10 A - 250 V	

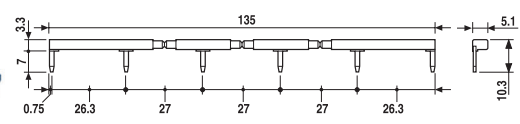

99.80

Approvals  
(according to type):



\* Modules in Black housing are available on request.

Green LED is standard.  
Red LED available on request.

<b>99.80 coil indication and EMC suppression modules for 94.84.2 socket</b>		<b>Blue*</b>
Diode (+A1, standard polarity)	(6...220)V DC	99.80.3.000.00
LED	(6...24)V DC/AC	99.80.0.024.59
LED	(28...60)V DC/AC	99.80.0.060.59
LED	(110...240)V DC/AC	99.80.0.230.59
LED + Diode (+A1, standard polarity)	(6...24)V DC	99.80.9.024.99
LED + Diode (+A1, standard polarity)	(28...60)V DC	99.80.9.060.99
LED + Diode (+A1, standard polarity)	(110...220)V DC	99.80.9.220.99
LED + Varistor	(6...24)V DC/AC	99.80.0.024.98
LED + Varistor	(28...60)V DC/AC	99.80.0.060.98
LED + Varistor	(110...240)V DC/AC	99.80.0.230.98
RC circuit	(6...24)V DC/AC	99.80.0.024.09
RC circuit	(28...60)V DC/AC	99.80.0.060.09
RC circuit	(110...240)V DC/AC	99.80.0.230.09
Residual current by-pass	(110...240)V AC	99.80.8.230.07



94.94.3

Approvals  
(according to type):



094.91.3

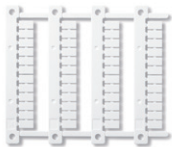

<b>Screw terminal (Box clamp) socket panel or 35 mm rail mount</b>	<b>94.92.3 (blue)</b>	<b>94.92.30 (black)</b>	<b>94.94.3 (blue)</b>	<b>94.94.30 (black)</b>
For relay type	55.32		55.32, 55.34	
<b>Accessories</b>				
Metal retaining clip	094.71			
Plastic retaining and release clip	094.91.3	094.91.30	094.91.3	094.91.30
6-way jumper link	094.06	094.06.0	094.06	094.06.0
Identification tag	094.80.3			
Modules (see table below)	99.80			
Sheet of marker tags for retaining and release clip 094.91.3, plastic, 48 tags, 6 x 12 mm for CEMBRE thermal transfer printers	060.48			
<b>Technical data</b>				
Rated values	10 A - 250 V			
Dielectric strength	2 kV AC			
Protection category	IP 20			
Ambient temperature	°C -25...+70			
Screw torque	Nm 0.5			
Wire strip length	mm 8			
Max. wire size for 94.92.3 and 94.94.3 sockets	solid wire		stranded wire	
	mm <sup>2</sup> 1 x 6 / 2 x 2.5		1 x 4 / 2 x 2.5	
	AWG 1 x 10 / 2 x 14		1 x 12 / 2 x 14	

060.48

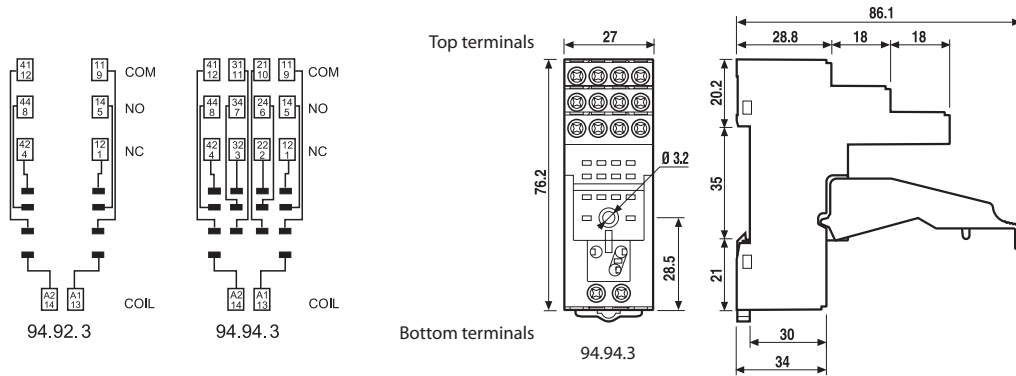

<b>6-way jumper link for 94.92.3 and 94.94.3 sockets</b>	<b>094.06 (blue)</b>	<b>094.06.0 (black)</b>
Rated values	10 A - 250 V	

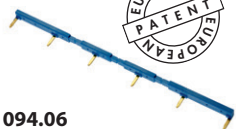

094.06

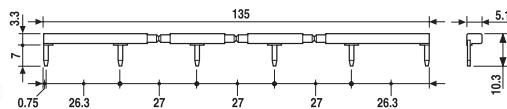

<b>99.80 coil indication and EMC suppression modules for 94.92.3 and 94.94.3 sockets</b>		<b>Blue*</b>
Diode (+A1, standard polarity)	(6...220)V DC	99.80.3.000.00
LED	(6...24)V DC/AC	99.80.0.024.59
LED	(28...60)V DC/AC	99.80.0.060.59
LED	(110...240)V DC/AC	99.80.0.230.59
LED + Diode (+A1, standard polarity)	(6...24)V DC	99.80.9.024.99
LED + Diode (+A1, standard polarity)	(28...60)V DC	99.80.9.060.99
LED + Diode (+A1, standard polarity)	(110...220)V DC	99.80.9.220.99
LED + Varistor	(6...24)V DC/AC	99.80.0.024.98
LED + Varistor	(28...60)V DC/AC	99.80.0.060.98
LED + Varistor	(110...240)V DC/AC	99.80.0.230.98
RC circuit	(6...24)V DC/AC	99.80.0.024.09
RC circuit	(28...60)V DC/AC	99.80.0.060.09
RC circuit	(110...240)V DC/AC	99.80.0.230.09
Residual current by-pass	(110...240)V AC	99.80.8.230.07



99.80

Approvals  
(according to type):



\* Modules in Black housing are available on request.

Green LED is standard. Red LED available on request.

A



94.74

Approvals  
(according to type):



94.82

Approvals  
(according to type):



<b>Screw terminal (Plate clamp) socket panel or 35 mm (EN 60715) rail mount</b>	<b>94.72</b>	<b>94.72.0</b>	<b>94.73</b>	<b>94.73.0</b>	<b>94.74</b>	<b>94.74.0</b>
	<b>Blue</b>	<b>Black</b>	<b>Blue</b>	<b>Black</b>	<b>Blue</b>	<b>Black</b>
For relay type	55.32		55.33		55.32, 55.34	
<b>Accessories</b>						
Metal retaining clip (supplied with socket - packaging code SMA)					094.71	
Modules (see table below)					99.01	
<b>Screw terminal (Plate clamp) socket: panel or 35 mm rail mount</b>	<b>94.82 (blue)</b>			<b>94.82.0 (black)</b>		
For relay type	55.32		55.32			
<b>Accessories</b>						
Metal retaining clip (supplied with socket - packaging code SMA)					094.71	
Modules (see table below)					99.01	
<b>Technical data</b>						
Rated values	10 A - 250 V					
Dielectric strength	2 kV AC					
Protection category	IP 20					
Ambient temperature	°C -40...+70					
Screw torque	Nm 0.5					
Wire strip length	mm 8 (94.72/73/74)			9 (94.82)		
Max. wire size for 94.72/73/74 and 94.82 sockets	solid wire			stranded wire		
	mm <sup>2</sup> 1 x 2.5 / 2 x 1.5			1 x 2.5 / 2 x 1.5		
	AWG 1 x 14 / 2 x 16			1 x 14 / 2 x 16		

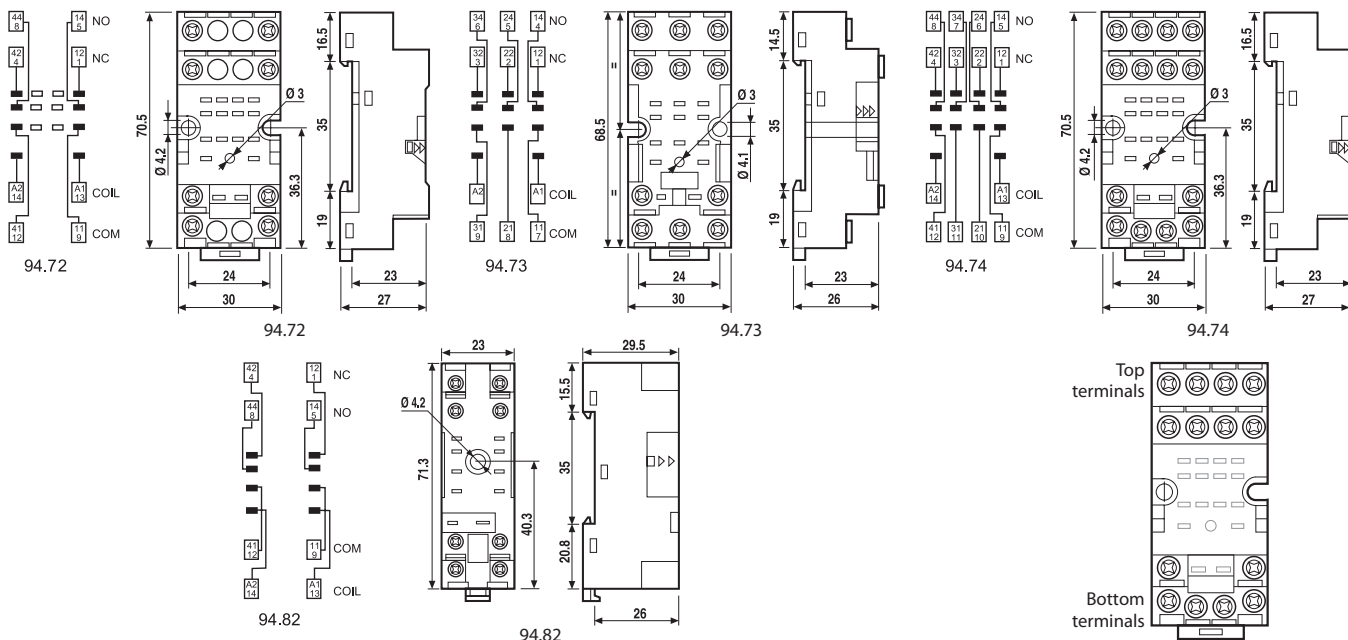

99.01

Approvals  
(according to type):



\* Modules in Black housing are available on request.

Green LED is standard.  
Red LED available on request.

99.01 coil indication and EMC suppression modules for 94.72, 94.73, 94.74 and 94.82 sockets		Blue*
Diode (+A1, standard polarity)	(6...220)V DC	99.01.3.000.00
Diode (+A2, non standard polarity)	(6...220)V DC	99.01.3.000.00
LED	(6...24)V DC/AC	99.01.0.024.59
LED	(28...60)V DC/AC	99.01.0.060.59
LED	(110...240)V DC/AC	99.01.0.230.59
LED + Diode (+A1, standard polarity)	(6...24)V DC	99.01.9.024.99
LED + Diode (+A1, standard polarity)	(28...60)V DC	99.01.9.060.99
LED + Diode (+A1, standard polarity)	(110...220)V DC	99.01.9.220.99
LED + Diode (+A2, non standard polarity)	(6...24)V DC	99.01.9.024.99
LED + Diode (+A2, non standard polarity)	(28...60)V DC	99.01.9.060.99
LED + Diode (+A2, non standard polarity)	(110...220)V DC	99.01.9.220.99
LED + Varistor	(6...24)V DC/AC	99.01.0.024.98
LED + Varistor	(28...60)V DC/AC	99.01.0.060.98
LED + Varistor	(110...240)V DC/AC	99.01.0.230.98
RC circuit	(6...24)V DC/AC	99.01.0.024.09
RC circuit	(28...60)V DC/AC	99.01.0.060.09
RC circuit	(110...240)V DC/AC	99.01.0.230.09
Residual current by-pass	(110...240)V AC	99.01.8.230.07



A



94.14

Approvals  
(according to type):



PCB socket	94.12 Blue	94.12.0 Black	94.13 Blue	94.13.0 Black	94.14 Blue	94.14.0 Black
For relay type	55.32		55.33		55.32, 55.34	
<b>Accessories</b>						
Metal retaining clip (supplied with socket - packaging code SMA)	094.51					
<b>Technical data</b>						
Rated values	10 A - 250 V					
Dielectric strength	2 kV AC					
Ambient temperature	°C -40...+70					

Copper side view

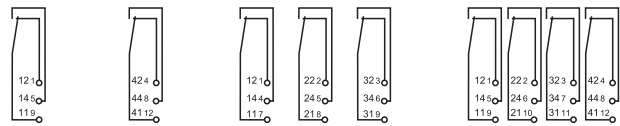
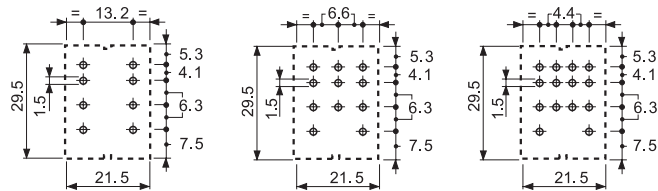
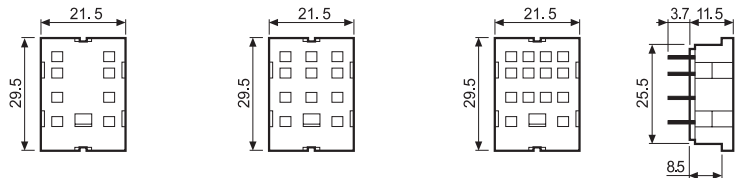

94.12

94.13

94.14



94.22

Approvals  
(according to type):



Panel mount solder socket 1 mm thick panel	94.22 Blue	94.22.0 Black	94.23 Blue	94.23.0 Black	94.24 Blue	94.24.0 Black
For relay type	55.32		55.33		55.32, 55.34	
<b>Accessories</b>						
Metal retaining clip (supplied with socket - packaging code SMA)	094.51					
<b>Technical data</b>						
Rated values	10 A - 250 V					
Dielectric strength	2 kV AC					
Ambient temperature	°C -40...+70					

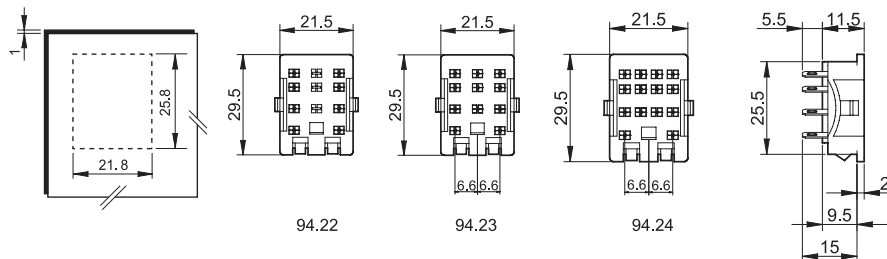

94.22

94.23

94.24



A 94.34

Approvals  
(according to type):



Panel mount socket M3 screw fixing - solder connections	94.32 Blue	94.32.0 Black	94.33 Blue	94.33.0 Black	94.34 Blue	94.34.0 Black
For relay type	55.32		55.33		55.32, 55.34	
<b>Accessories</b>						
Metal retaining clip (supplied with socket - packaging code SMA)	094.51					
<b>Technical data</b>						
Rated values	10 A - 250 V					
Dielectric strength	2 kV AC					
Ambient temperature	°C -40...+70					

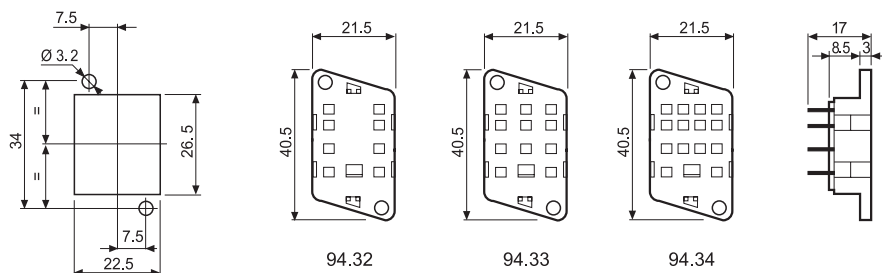

## Packaging codes

How to code and identify retaining clip and packaging options for sockets.

Example:

