



# ISD300-1221

ISD300

OPTICAL DATA TRANSMISSION

**SICK**  
Sensor Intelligence.



### Ordering information

Type	Part no.
ISD300-1221	6024838

Other models and accessories → [www.sick.com/ISD300](http://www.sick.com/ISD300)



### Detailed technical data

#### Performance

<b>Transmission range</b>	0.2 m ... 200 m
<b>Light source</b>	LED, infrared (880 nm)
<b>Typ. light spot size (distance)</b>	1.75 m (at 100 m)
<b>Aperture angle</b>	Ca. ± 0.5°
<b>Heating</b>	✓

#### Interfaces

<b>PROFIBUS DP</b>	✓
Data transmission rate	1.5 Mbit/s
<b>Serial</b>	✓, RS-485
Remark	On request
Data transmission rate	1.5 Mbit/s
<b>Switching output</b>	0 V ... 2 V: interference-free operation V <sub>S</sub> -2 V: reduced system reserve
<b>Switching input</b>	0 V ... 2 V: sender deactivated
<b>Signal delay</b>	≤ 1.5 μs, + 1 Tbit

#### Mechanics/electronics

<b>Supply voltage V<sub>s</sub></b>	DC 18 V ... 30 V
<b>Housing material</b>	Metal
<b>Connection type</b>	Terminals
<b>Weight</b>	Approx. 1.2 kg
<b>Current consumption</b>	≤ 0.8 A
<b>Frequency</b>	F1 <sup>1)</sup>
<b>Enclosure rating</b>	IP65
<b>Protection class</b>	I

<sup>1)</sup> A pair of devices with numbers ending in 1 and 2 are required to create a data transfer section.

## Ambient data

<b>Electromagnetic compatibility (EMC)</b>	EN 61000-6-2, EN 61000-6-4 <sup>1)</sup>
<b>Ambient temperature</b>	Storage: -30 °C ... +70 °C
<b>Ambient temperature operation</b>	-30 °C ... +50 °C
<b>Max. rel. humidity (not condensing)</b>	90 %, Non-condensing

<sup>1)</sup> This is a Class A device. This device can cause radio interference in living quarters.

## Classifications

<b>ECl@ss 5.0</b>	19039001
<b>ECl@ss 5.1.4</b>	19039001
<b>ECl@ss 6.0</b>	19179090
<b>ECl@ss 6.2</b>	19179090
<b>ECl@ss 7.0</b>	19179090
<b>ECl@ss 8.0</b>	19179090
<b>ECl@ss 8.1</b>	19179090
<b>ECl@ss 9.0</b>	19179090
<b>ETIM 5.0</b>	EC000515
<b>ETIM 6.0</b>	EC000515
<b>UNSPSC 16.0901</b>	43201404

## Dimensional drawing (Dimensions in mm (inch))

ISD300 RS-485/PROFIBUS, ISD300 RS-422/Interbus, ISD300 DH+/RIO, ISD300 DeviceNet/CANopen

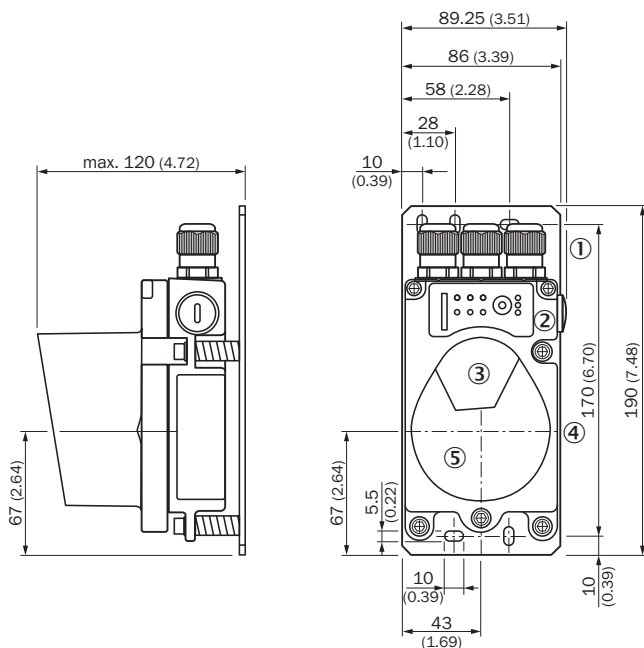

- ① M16 gland
- ② Control panel
- ③ Sender lens
- ④ Center of optical axis
- ⑤ Receiver lens

### Connection type

ISD300 RS-485/PROFIBUS

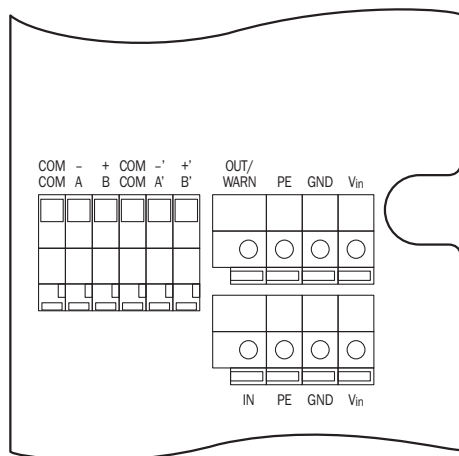

### Connection diagram

#### Terminals, general

<b>V<sub>in</sub></b>	L+
<b>GND</b>	M
<b>PE</b>	Shield
<b>OUT/WARN</b>	Q
<b>IN</b>	Switch. input

#### Terminals, PROFIBUS

<b>A, -</b>	A wire
<b>B, +</b>	B wire
<b>COM</b>	Pot. balance
<b>A', -'</b>	A wire
<b>B', +'</b>	B wire

### Adjustment possible

ISD300 RS-485/PROFIBUS, ISD300 RS-422/Interbus, ISD300 DH+/RIO, ISD300 DeviceNet/CANopen

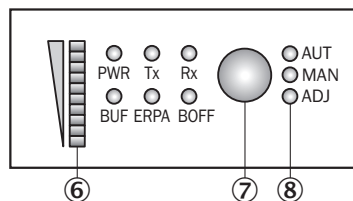

- ⑥ Display for signal level
- ⑦ Operating mode selector switch
- ⑧ LED operating indicator

## Recommended accessories

Other models and accessories → [www.sick.com/ISD300](http://www.sick.com/ISD300)

	Brief description	Type	Part no.
<b>Plug connectors and cables</b>			
	Head A: cable Head B: cable Cable: PROFIBUS DP, drag chain use, PUR, shielded	LTG-2102-MW	6021355
	Head A: cable Head B: cable Cable: CANopen, DeviceNet™, drag chain use, shielded Wire shield Al-Pt film, overall shield C-screen tin-plated	LTG-2804-MW	6028328
	Head A: male connector, M12, 5-pin, straight, B-coded Head B: cable Cable: PROFIBUS DP, drag chain use, PUR, halogen-free, shielded, 5 m Wire shield Al-Pt film, overall shield C-screen tin-plated	STL-1205-G05MQ	6026005
	Head A: female connector, M12, 5-pin, straight Cable: CANopen, DeviceNet™, shielded	DOS-1205-GA	6027534
	Head A: female connector, M12, 5-pin, straight, B-coded Head B: - Cable: PROFIBUS DP, shielded	DOS-1205-GQ	6021353
	Head A: male connector, M12, 5-pin, straight, A-coded Cable: CANopen, DeviceNet™, shielded	STE-1205-GA	6027533
	Head A: male connector, M12, 5-pin, straight, B-coded Head B: - Cable: PROFIBUS DP, shielded	STE-1205-GQ	6021354

## SICK AT A GLANCE

SICK is one of the leading manufacturers of intelligent sensors and sensor solutions for industrial applications. A unique range of products and services creates the perfect basis for controlling processes securely and efficiently, protecting individuals from accidents and preventing damage to the environment.

We have extensive experience in a wide range of industries and understand their processes and requirements. With intelligent sensors, we can deliver exactly what our customers need. In application centers in Europe, Asia and North America, system solutions are tested and optimized in accordance with customer specifications. All this makes us a reliable supplier and development partner.

Comprehensive services complete our offering: SICK LifeTime Services provide support throughout the machine life cycle and ensure safety and productivity.

For us, that is “Sensor Intelligence.”

## WORLDWIDE PRESENCE:

Contacts and other locations –[www.sick.com](http://www.sick.com)