

Overload relay

Motor protection is one of the most important tasks when machines are to be equipped electrically. You will find the correct solution for every application, from the price efficient bimetal solution up to the more demanding networked, full motor protection.



Bimetal overload relays

Overload relays up to 630 A

- Saves mounting time due to direct mounting onto contactor
- ATEX approval for the protection of EEx e motors up to 250 A
- Single-phasing sensitivity offers wide-ranging motor protection
- Integrated Test button gives higher safety

Page 6/6



ZEV electronic motor-protective relay

Overload relays up to 820 A

- Flexible mounting using Rogowski current transformers
- Simple parameterisation reduced commissioning time
- ATEX approval for the protection of EEx e motors
- Short downtime due to error messages in display
- Additional thermistor evaluation offers full motor protection

Page 6/12



EMT6 thermistor machine protection relays

- Overload protection by direct evaluation of the winding temperature
- Fast recognition of operating state by LED display
- Suitable for overload monitoring of EEx e motors
- Reduced variants due to wide-range power supply

Page 6/16



	Page
Overload relays ZE, ZB, Z5, ZW7	
Technical overview	6/2
Ordering	
Bimetal overload relays for mini contactors	6/4
Bimetal overload relays up to 150A	6/6
Bimetal overload relays greater than 150 A, CT-operated overload relays	6/11
Accessories	6/18
Engineering	
Selection data	6/19
Technical data:	
Bimetal overload relays up to 150A	6/20
Bimetal overload relays greater than 150 A, CT-operated overload relays	6/21
Dimensions	
Bimetal overload relays up to 150A	6/26
Bimetal overload relays greater than 150 A, CT-operated overload relays	6/28
ZEV electronic motor-protective relay	
Technical overview	6/2
Description	6/12
Ordering	
Basic devices	6/20
Accessories	6/21
Engineering	
Selection aids	6/13
Characteristic curves	6/13
Technical data	6/23
Dimensions	6/29
EMT6 thermistor machine protection relays	
Technical overview	6/2
Ordering	
Basic devices	6/16
Accessories	6/16
Technical data	6/25
Dimensions	6/28

Setting ranges (A)
(Note max. current of
the contactor)



DILM15

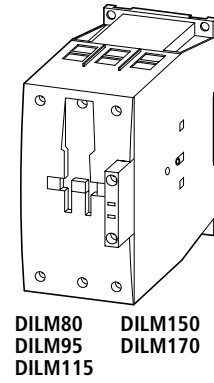
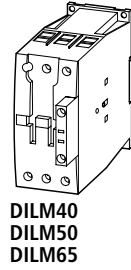

DILM150
DILM170

Overload relays

ZE

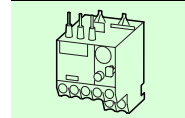

ZB12
0.1 – 16

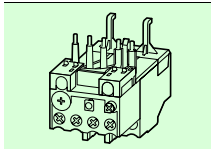

ZB32
0.1 – 32

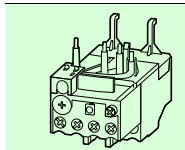

ZB65
6 – 65

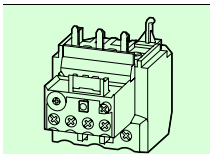

ZB150
25-150

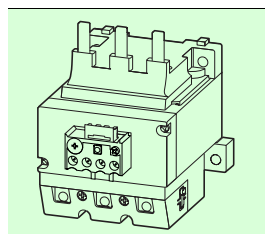

Z5-.../FF250
50-250

CT-operated overload relay

ZW7-...¹⁾
42 – 630

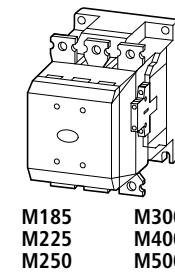

M300
M400
M500

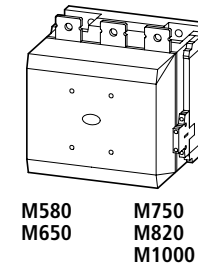

DILM1600

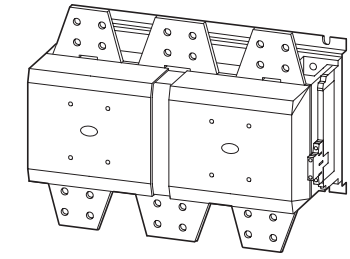

Electronic motor-protective relay

ZEV²⁾
1 – 820

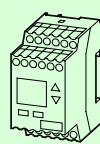

Thermistor machine protection overload relays

EMT6((DB)K)

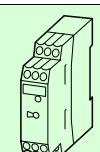

Notes

- ¹⁾ Can only be used up to DILM580
- ²⁾ Can only be used up to DILM820



ZE Moeller HPL0211-2007/2008 <http://catalog.moeller.net>

Overload releases	Contact sequence	Auxiliary contacts		For use with	Short-circuit protection	
		N/O = Normally	N/C = Normally		Type "1" coordination	Type "2" coordination
I_r					gG/gL	gG/gL
A				A	A	A

ZE overload relay for mini contactorPhase failure sensitivity to IEC/EN 60947
For direct mounting

PTB 01 ATEX 3331

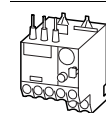

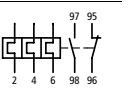
Overload release	Contact sequence	Auxiliary contacts	For use with	Short-circuit protection
0.1...0.16		1 N/O	1 N/C	DILEM DIULEM/21/MV SDAINLEM
0.16...0.24				20
0.24...0.4				0.5
0.4...0.6				1
0.6...1				2
1...1.6				2
1.6...2.4				4
2.4...4				6
4...6				6
6...9				10

<http://catalog.moeller.net> Moeller HPL0211-2007/2008 ZE

Part no. Article no.	Price see price list	Std. pack	Notes
ZE-0,16 014263		1 off	Overload release: tripping class 10 A Short-circuit protection: Observe the maximum permissible fuse of the contactor with direct device mounting.  Observe manual AWB2300-1425, German or English.
ZE-0,24 014285			
ZE-0,4 014300			
ZE-0,6 014333			
ZE-1,0 014376			
ZE-1,6 014432			
ZE-2,4 014479			
ZE-4 014518			
ZE-6 014565			
ZE-9 014708			

When fitted directly to the contactor a clearance of at least 5 mm is required between the overload relays.

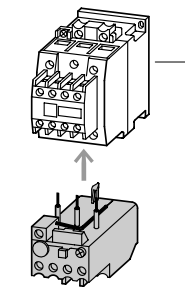
1 Contactor
Accessories
Manual

→ page 5/3
 → page 2/39
 → page 6/18





ZB

Moeller HPL0211-2007/2008

http://catalog.moeller.net

Setting range
Overload releases

Contact sequence

Auxiliary contacts

For use with

Short-circuit protection



N/O =
Normally

N/C =
Normally

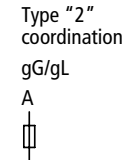
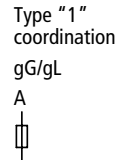

ZB12 overload relays

Phase failure sensitivity to IEC/EN 60947, VDE 0660 Part 102
For direct mounting

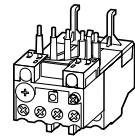

0.1...0.16
0.16...0.24
0.24...0.4
0.4...0.6
0.6...1
1...1.6
1.6...2.4
2.4...4
4...6
6...10
9...12
12...16

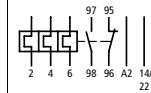

1 N/O

1 N/C

DILM7, DILM9,
DILM12,
DILM15,
DIULM7,
DIULM9,
DIULM12,
SDAINLM12,
SDAINLM16,
SDAINLM22

25	0.5
	1
	2
	4
	4
	6
	10
	16
	20
50	25

ZB32 overload relays

Phase failure sensitivity to IEC/EN 60947, VDE 0660 Part 102
For direct mounting

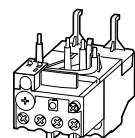

0.1...0.16
0.16...0.24
0.24...0.4
0.4...0.6
0.6...1
1...1.6
1.6...2.4
2.4...4
4...6
6...10
10...16
16...24
24...32

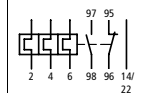

1 N/O

1 N/C

DILM17,
DILM25,
DILM32,
DIULM17,
DIULM25,
DIULM32,
SDAINLM30,
SDAINLM45,
SDAINLM55

25	0.5
	1
	2
	4
	4
	6
	10
	16
	20
50	25
63	35
100	35
125	63



ZB

Moeller HPL0211-2007/2008

http://catalog.moeller.net

Part no.
Article no.

Price
see price list

Std. pack

Notes

ZB12-0,16 278431
ZB12-0,24 278432
ZB12-0,4 278433
ZB12-0,6 278434
ZB12-1 278435
ZB12-1,6 278436
ZB12-2,4 278437
ZB12-4 278438
ZB12-6 278439
ZB12-10 278440
ZB12-12 278441
ZB12-16 290168

1 off

Overload release: tripping class 10 A
Short-circuit protection: Observe the maximum permissible fuse of the contactor with direct device mounting.
Suitable for protection of EEx e-motors.
Ex
PTB 04 ATEX 3022
Observe manual AWB2300-1527D/GB.

Fitted directly to the contactor

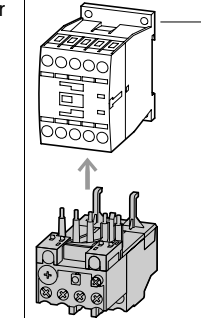

1 Contactor

→ 5/17

ZB32-0,16 278442
ZB32-0,24 278443
ZB32-0,4 278444
ZB32-0,6 278445
ZB32-1 278446
ZB32-1,6 278447
ZB32-2,4 278448
ZB32-4 278449
ZB32-6 278450
ZB32-10 278451
ZB32-16 278452
ZB32-24 278453
ZB32-32 278454

1 off

Overload release: tripping class 10 A
Short-circuit protection: Observe the maximum permissible fuse of the contactor with direct device mounting.
Suitable for protection of EEx e-motors.
Ex
PTB 04 ATEX 3022
Observe manual AWB2300-1527D/GB.

Fitted directly to the contactor Separate mounting

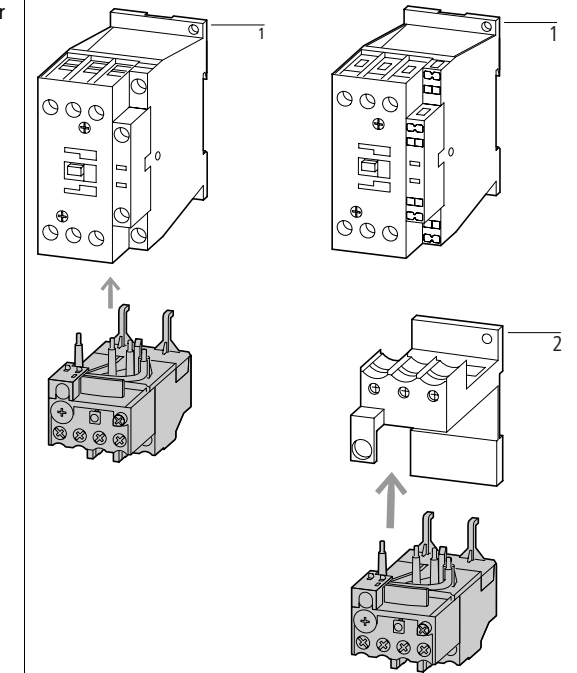

1 Contactor
2 Bases

→ 5/17
→ 6/18



Overload releases	Contact sequence	Auxiliary contacts		For use with	Short-circuit protection	
		N/O = Normally	N/C = Normally		Type "1" coordination gG/gL	Type "2" coordination gG/gL
I_r						
A				A	A	

Overload relays ZB65
Phase failure sensitivity to IEC/EN 60947, VDE 0660 Part 102
For direct mounting

Overload release	Contact sequence	N/O	N/C	For use with	Type "1" coordination gG/gL	Type "2" coordination gG/gL
6...10		1 N/O	1 N/C	DILM40, DILM50, DILM65, DIULM40, DIULM50, DIULM65, SDAINLM70, SDAINLM90, SDAINLM115	50	25
10...16					63	35
16...24					63	50
24...40					125	63
40...57					160	80
50...65				160	100	
35...50		1 N/O	1 N/C	DILM80, DILM95, DILM115, DILM150, DILM170, DIULM80, DIULM95, DIULM115, DIULM150, SDAINLM140, SDAINLM165, SDAINLM200, SDAINLM260	160	125
50...70					250	160
70...100					315	200
95...125					315	250
120...150					315	250
145...175					315	250

Overload release	Contact sequence	N/O	N/C	For use with	Type "1" coordination gG/gL	Type "2" coordination gG/gL
35...50		1 N/O	1 N/C	DILM80, DILM95, DILM115, DILM150, DILM170, DIULM80, DIULM95, DIULM115, DIULM150, SDAINLM140, SDAINLM165, SDAINLM200, SDAINLM260	160	125
50...70					250	160
70...100					315	200
95...125					315	250
120...150					315	250
145...175				400	315	

Bimetal Relay



Part no. Article no.	Price see price list	Std. pack	Notes	
ZB65-10 278455		1 off	<p>Overload release: tripping class 10 A Short-circuit protection: Observe the maximum permissible fuse of the contactor with direct device mounting.</p> <p>Suitable for protection of EEx e-motors.</p> <p></p> <p>PTB 04 ATEX 3022</p> <p>Observe manual AWB2300-1545D/GB.</p>	
ZB65-16 278456				
ZB65-24 278457				
ZB65-40 278458				
ZB65-57 278459				
ZB65-65 278460				
ZB150-50 278462				
ZB150-70 278463				
ZB150-100 278464				
ZB150-125 278465				
ZB150-150 278466				
ZB150-175 107316				
ZB150-50/KK 278468		1 off		<p>Overload release: tripping class 10 A Short-circuit protection: Observe the maximum permissible fuse of the contactor with direct device mounting.</p> <p>Suitable for protection of EEx e-motors.</p> <p></p> <p>PTB 04 ATEX 3022</p> <p>Observe manual AWB2300-1545D/GB.</p>
ZB150-70/KK 278469				
ZB150-100/KK 278470				
ZB150-125/KK 278471				
ZB150-150/KK 278472				
ZB150-175KK 107317				

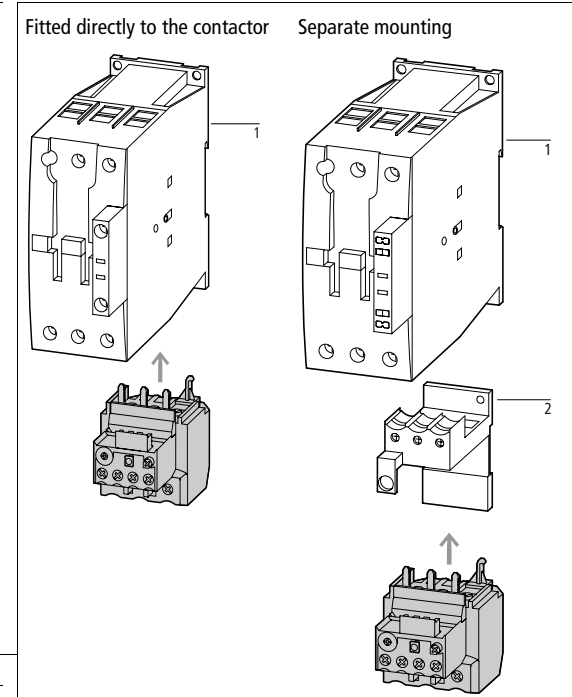



Bimetal Relay



Z5, ZW7

Moeller HPL0211-2007/2008 <http://catalog.moeller.net>

Overload releases	Contact sequence	Auxiliary contacts		For use with	Short-circuit protection	
		N/O = Normally	N/C = Normally		Type "1" coordination gG/gL	Type "2" coordination gG/gL
I_r					A	A
						

Overload relay Z5 greater than 150A

Phase failure sensitivity to IEC/EN 60947

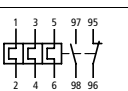
Current range (A)	Diagram	1 N/O	1 N/C	For use with	Type "1" coordination gG/gL	Type "2" coordination gG/gL
50...70				DILM185	250	160
70...100				DILM225	315	200
95...125				DILM250	315	250
120...160					400	250
160...220				Direct mounting	400	315
				Separate mounting	500	400
200...250				Direct mounting	400	315
			Separate mounting	500	400	

ZW7 current transformer-operated overload relays

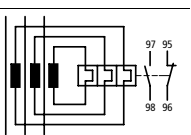
Current range (A)	Diagram	1 N/O	1 N/C	For use with	Type "1" coordination gG/gL	Type "2" coordination gG/gL
42...63				-	-	-
60...90				-	-	-
85...125				-	-	-
110...160				-	-	-
160...240				-	-	-
190...290				-	-	-
270...400				-	-	-
360...540				-	-	-
420...630			-	-	-	

Bimetal Relay



Z5, ZW7

<http://catalog.moeller.net> Moeller HPL0211-2007/2008

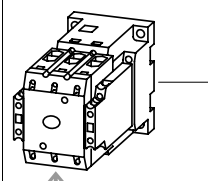
Part no. Article no.	Price see price list	Std. pack	Notes	Notes
Z5-70/FF250 210070		1 off	Overload release: tripping class 10 A Short-circuit protection: Observe the maximum permissible fuse of the contactor.	<p>Fitted directly to the contactor</p>  <p>1 Contactor Accessories</p> <p>→ page 5/25 → page 2/39</p>
Z5-100/FF250 210071				
Z5-125/FF250 210072				
Z5-160/FF250 210073				
Z5-220/FF250 210074				
Z5-250/FF250 210075				
ZW7-63 000245		1 off		The main current parameters are defined by the main current wiring which is used.
ZW7-90 002618				
ZW7-125 004991				
ZW7-160 007364				
ZW7-240 009737				
ZW7-290 052448				
ZW7-400 045329				
ZW7-540 047702				
ZW7-630 050075				

Bimetal Relay



ZEV – electronic overload relay for motor currents from 1 ... 820 A

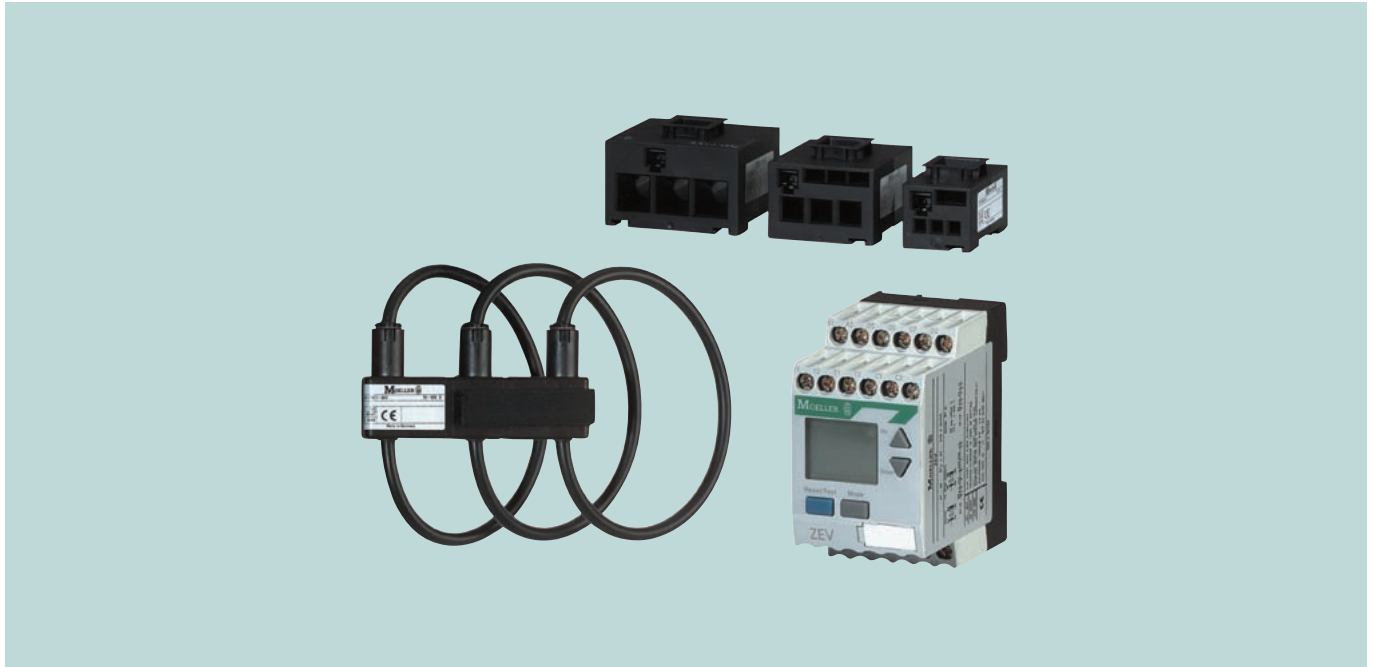

General

Technological advances require completely new approaches: the application of newly developed sensor systems and tripping units has made motor protection considerably simpler and more economical. All Z overload relays provide the standard functions: protection in the event of phase failure, overload, or current imbalance. The innovative ZEV motor-protective system from Moeller can now do all these things and much more:

Application

Even the most severe starting situations can be dealt with by the ZEV motor-protective system. The enhanced tripping classes (up to CLASS40) provide reliable protection for motors with starting times of up to 40 seconds. Protection for any motor starting situation can be optimally set by preselecting one of the eight tripping classes between 5 and 40 seconds. An earth fault is quickly detected by the external core-balance transformers. The integrated thermistor connection allows the relay to be upgraded to provide a full motor-protective system.

Handling

The LCD display guides the user through the setting menus and ensures straightforward operation. In the event of a fault, the display shows the cause of the fault and enables rapid fault identification.

Additional signal cables can be implemented via the freely configurable auxiliary contacts 05-06 and 07-08.

They can each be assigned one of the following functions:

- Early warning of overload
- Earth fault
- Thermistor tripping
- Internal fault

Engineering

The multi-voltage module automatically adapts to different voltages from 24 ... 240 V, 50/60 Hz, and 24 ... 240 V DC, thus enabling flexible application with all conventional control voltages.

Mounting

Ring-type sensors enable the innovative ZEV motor protection system to be used also for small motors. With large motor currents and cable cross-sections, the sensor cables are simply wound round the incoming cable.

A main current wiring system and complex cable matching for an additional device are no longer necessary, neither is the drilling of the mounting plate. Instead, the sensors are simply fastened with a Velcro fastener.

This saves mounting time and expense. The volume of 58 times less than conventional transformers enables the saving of valuable mounting space in the control panel.

	Length	Diameter	Overload releases	For use with	Fault currents	Part no. Article no.	Price see price list	Std. pack
	mm	mm	I_r A 		A			
ZEV								
PTB 01 ATEX 3233								
			1...820	DILEM...DILM820		ZEV 209634		1 off
Current sensors								
		6	1...25	DILEM DILM7...DILM25		ZEV-XSW-25 209635		1 off
		13	3...65	DILM7...DILM65		ZEV-XSW-65 209636		
		21	10...145	DILM12...DILM150		ZEV-XSW-145 209637		
		110	40...820	DILM40...DILM820		ZEV-XSW-820 209641		
Connecting cables								
	200			ZEV-XSW-25 ZEV-XSW-65 ZEV-XSW-145 ZEV-XSW-820		ZEV-XVK-20 209643		1 off
	400					ZEV-XVK-40 209644		
	800					ZEV-XVK-80 209645		
SSW core-balance transformers								
For earth-leakage monitoring								
		40			0.3	SSW40-0,3 028286		1 off
					0.5	SSW40-0,5 028305		
					1	SSW40-1 028306		
		65			0.5	SSW65-0,5 028307		
		65			1	SSW65-1 028316		
		120			0.5	SSW120-0,5 028319		
		120			1	SSW120-1 028321		
Fixing bracket								
				ZEV ZEV-XSW-25 ZEV-XSW-65 ZEV-XSW-145 easy..., MFD... PS4..., EM4... LE4...		ZB4-101-GF1 061360		9 off
Documentation								
ZEV motor protective relay Overload monitoring of EEx e motors								
	German					AWB2300-1433D 259711		1 off
	English					AWB2300-1433GB 267430		1 off

Electronic motor-protective relay



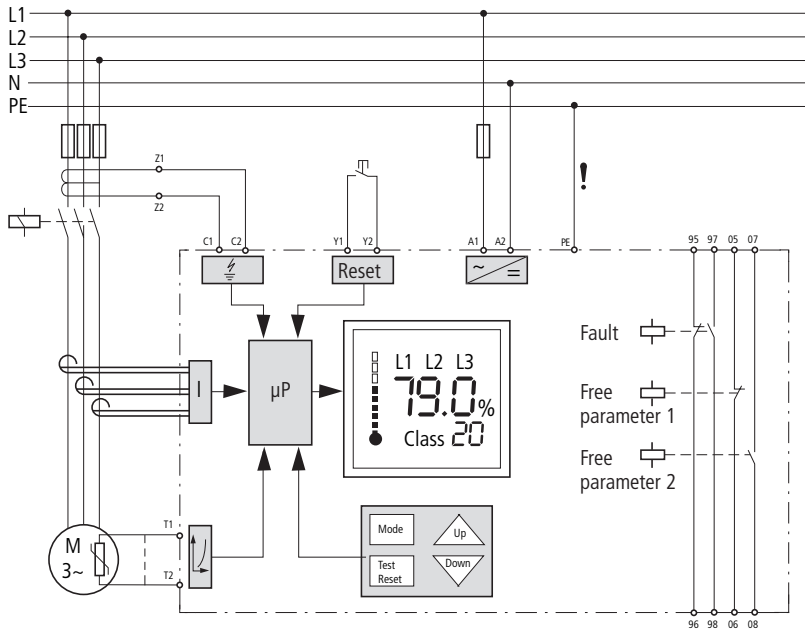

Menu

Class			
5	10	15	20
25	30	35	40

I_e	Free parameter 1
1 – 820 A	$I_e > 105\%$

Reset	Free parameter 2
Hand Auto	$I_e > 105\%$
ON OFF	IF ¹⁾

1) IF: Internal fault

Inputs		Outputs	
A 1/A 2	Rated control voltage	95/96	N/C contact overload/thermistor
T 1/T 2	Thermistor sensor	97/98	Make contact overload/thermistor
C 1/C 2	SSW core-balance transformer	05/06	N/C contact freely assignable
Y 1/Y 2	Remote reset	07/08	Make contact freely assignable

Switchgear and cable sizing correspond to the respective starting inertia (CLASS)

The switchgear is designed for "CLASS 10" in normal and overload operation. To ensure that the switchgear (circuit-breaker and contactor) as well as the cables are not overloaded with extended tripping times, they must be over-dimensioned accordingly. The rated operational current I_e for switchgear and cables can be calculated with the following current factor while taking the tripping class into account:

Tripping class	Class 5	Class 10	Class 15	Class 20	Class 25	Class 30	Class 35	Class 40
Current factor for rated operational current I_e	1.00	1.00	1.22	1.41	1.58	1.73	1.89	2.00

Rated motor currents < 1 A

With the ZEV-XSW-25 to ZEV-XSW-145 push-through sensors, the motor incomer cables for each phase are pushed through the push-through openings. With motor currents of less than 1 A, the motor incomer cables are looped into the ZEV-XSW25.

Number of loops n		4	3	2
Rated motor current I_N	A	0.25...0.32	0.33...0.49	0.5...0.99
Set current on the relay I_E between the lowest and highest values	A	1.00...1.28	1.00...1.47	1.00...1.98

The set current I_E of the device is calculated by: $I_E = n \times I_N$

Tripping characteristics

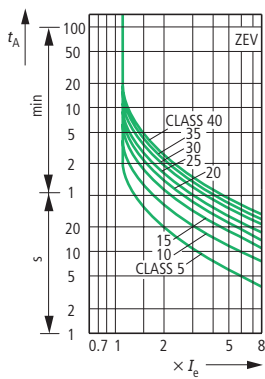

With a phase failure or unbalance > 50 %, the ZEV will trip within 2.5 seconds.

Tripping times for ZEV electronic motor-protective relay

Tripping class, adjustable	CLASS	5	10	15	20	25	30	35	40
Tripping times in s ($\pm 20\%$)		at 3-pole symmetric loading from cold state							
Current setting I_E	$\times 3$	11.3	22.6	34	45.3	56.6	67.9	79.2	90.5
	$\times 4$	8	15.9	23.9	31.8	39.8	47.7	55.7	63.6
	$\times 5$	6.1	12.3	18.4	24.6	30.7	36.8	43	49.1
	$\times 6$	5	10	15	20	25	30	35	40
	$\times 7.2$	4.1	8.2	12.3	16.4	20.5	24.5	28.6	32.7
	$\times 8$	3.6	7.3	10.9	14.6	18.2	21.9	25.5	29.2
	$\times 10$	2.9	5.7	8.6	11.5	14.4	17.2	20.1	23

Recovery time after overload trip
(Overview of the recovery time in min)

CLASS	5	10	15	20	25	30	35	40
t_{recovery} [min]	5	6	7	8	9	10	11	12

Thermistor tripping

Rated trip resistance $R = 3200 \Omega \pm 15\%$

Recovery resistance $R = 1500 \Omega + 10\%$

Total cold resistance $\Sigma R_K \leq 1500 \Omega$

at $R_K \leq 250 \Omega$ per sensor: 6 sensors

at $R_K \leq 100 \Omega$ per sensor: 9 sensors



Ready to respond after trip at 5 K under response temperature

Test button tripping time: 5 s

EC prototype test certification number: PTB 01 ATEX 3233

For protection of motors in EEx e area, also order AWB2300-1433G "ZEV motor-protective system, Overload monitoring of motors in EEX e areas".

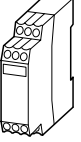
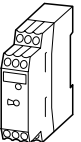
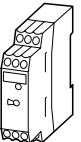

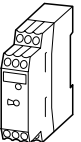
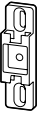
Description	Rated operational current	Conventional thermal current	Rated control voltage	Part no. Article no.	Price see price list	Std. pack
	AC-15 240 V I_e A	AC-14 400 V I_e A	I_{th} A V			
EMT6 thermistor machine protection relays						
 Without automatic reset Mains and fault LED display	3	3	6	24 – 240 V 50/60 Hz, 24 240 V DC	EMT6 066166	1 off
 Without automatic reset Mains and fault LED display Trip with short-circuit in the sensor cable				24 – 240 V 50/60 Hz, 24 – 240 V DC	EMT6-K 269470	
Without automatic reset Mains and fault LED display				230 V 50/60 Hz	EMT6(230V) 066400	
 Selector switch with/without automatic reset For manual or remote resetting Test button Mains and fault LED display				24 – 240 V 50/60 Hz, 24 – 240 V DC	EMT6-DB 066167	
 Selector switch with/without automatic reset For manual or remote resetting Test button Mains and fault LED display Trip with short-circuit in the sensor cable				24 – 240 V 50/60 Hz, 24 – 240 V DC	EMT6-KDB 269471	
Selector switch with/without automatic reset For manual or remote resetting Test button Mains and fault LED display				230 V 50/60 Hz	EMT6-DB(230V) 066401	
 Multifunction device Selector switch with/without automatic reset Trip with short-circuit in the sensor cable Zero-voltage safe For manual or remote resetting Test button Short-circuit recognition and zero-voltage safety can be deactivated Mains and fault LED display				24 – 240 V 50/60 Hz, 24 – 240 V DC	EMT6-DBK 066168	
Accessories						
Screw adapter For screw fixing						
					CS-TE 095853	10 off
Documentation						
EMT6 thermistor overload relay Overload monitoring of machines in the EEx e area						
German					AWB2327-1446D 264853	1 off
English					AWB2327-1446GB 267010	1 off

Terminal marking according to EN 50005

Notes

Flow Diagrams

LED display

Supply voltage is available

Device has tripped

Device has tripped/short-circuit in the sensor circuit

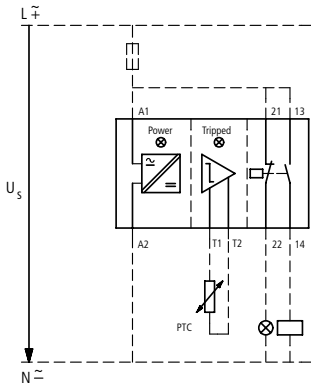

EMT6-K, EMT6-(K)DB, EMT6-DBK Auto

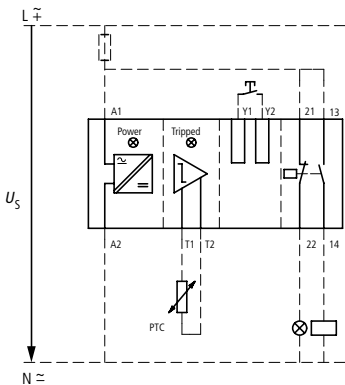
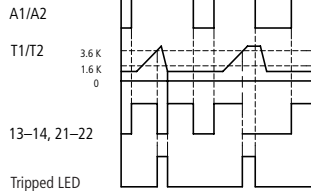

EMT6-(K)DB, EMT6-DBK Hand

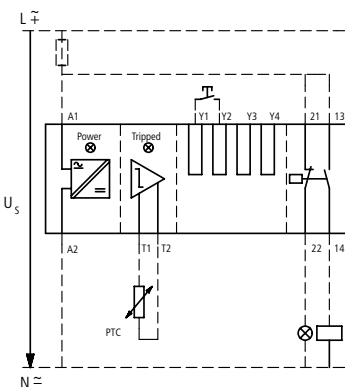
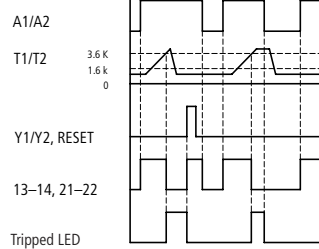

EMT6-DBK Zero-voltage safe operation

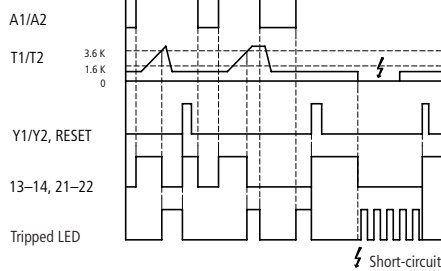

PTB 02 ATEX 3162

With the EMT6, EMT6(230V), EMT6-DB and EMT6-DB(230V) an additional short-circuit protection in the sensor circuit with current monitor is to be provided. Observe the AWB2327-1446 manual (a 6/16).

Can be snap fitted on a top-hat rail to IEC/EN 60715.

At $R_K \leq 250 \Omega$ per sensor: 6 sensors, at $R_K \leq 100 \Omega$ per sensor: 9 sensors in the winding (fitted by customer), max. cable length to sensor 250 m (non-screened); Total thermistor resistance (cold) $\Sigma R_K \leq 1500 \Omega$

Sensor circuit characteristic values at U_s and $+20^\circ\text{C}$

R_{T1-T2}	EMT6... U_{T1-T2} V DC max.	I_{T1-T2} mA max.
T1, T2 short-circuited	—	1,9
4 k Ω	3	0,8
T1-T2 open	5,1	—

Functions that can be disconnected on the EMT6-DBK:

Function	disconnection via link
Short-circuit detection	$Y_1 - Y_3$
Zero voltage safety	$Y_1 - Y_4$

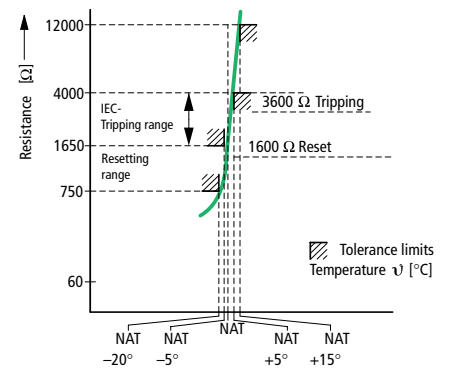

	For use with	Part no. Article no.	Price see price list	Std. pack	Notes
Documentation					
Overload relays Overload monitoring of EEx e motors					
	ZB12... ZB32...	AWB2300-1527D/GB 284910		1 off	German/English
	ZB65... ZB150...	AWB2300-1545D/GB 102065			
Bases					
For separate mounting					
	ZB32	ZB32-XEZ 278473		5 off	Can be snap fitted on a top-hat rail to IEC/EN 60715 or can be screw fitted.
	ZB65	ZB65-XEZ 278474		1 off	
Push-buttons					
For enclosed overload relays Mounting diameter: 22.3 mm					
External reset button IP65					
	ZW7... ZB12 ZB32 ZB65 ZB150	M22-DZ-B 254833		10 off	Blue button plate
	ZW7... ZB12 ZB32 ZB65 ZB150	M22-DZ-B-GB14 254834			Blue button plate: RESET
Off button, IP65					
	ZW7... ZB12 ZB32 ZB65 ZB150	M22-DZ-X 254835		10 off	Without button plate, button plate must be added
Button plates					
	M22-DZ-X	M22-XD-R 216423		10 off	Red legend plate
		M22-XD-R-X0 218153			Button plate, red with white circle
		M22-XD-R-GB0 218194			Red legend plate STOP
Covers					
	Z5-.../FF250	Z5/FF250-XHB 215217		1 off	Separate mounting
	Direct fitting Z5-.../FF250 to DILM185, DILM225, DILM250	Z5/FF250-XHB-Z 215218			Fitted directly to the contactor

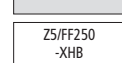
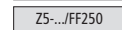
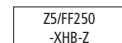
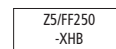
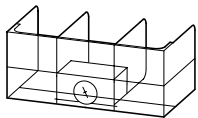
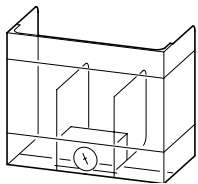

Selection data

	ZE ZB12	ZB32, ZB65, ZB150	Z5	ZW7	ZEV
Phase-failure sensitivity	●	●	●	—	●
Temperature compensation	●	●	●	●	●
Auxiliary switch 1 M + 1 B	●	●	●	●	●
Test/off button	●	●	●	●	●
Reset button manual/auto	●	●	●	●	●
Separate mounting	—	●	●	●	●
Protection of EEx e-motors (PTB)	●	●	●	—	●
Protection with heavy starting duty	—	—	—	●	●
Trip-free release	●	●	●	●	●

P standard features

EU prototype test certificate number

ZEV	PTB 01 ATEX 3233
ZE	PTB 01 ATEX 3331
ZB12	PTB 04 ATEX 3022
ZB32	PTB 04 ATEX 3022
ZB65	PTB 04 ATEX 3022
ZB150	PTB 04 ATEX 3022
EMT6	PTB 02 ATEX 3162

Protection of single-phase and DC current motors:

1 pole

2 pole

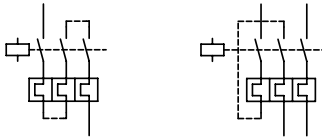

Mounting position:

ZE

ZB12, ZB32, ZB65, ZB150, Z5

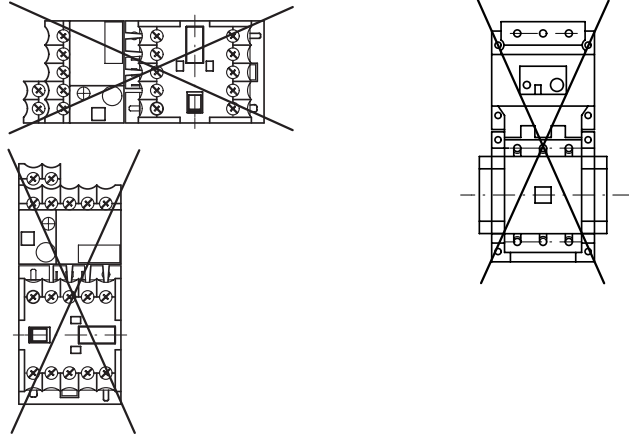

These tripping characteristics are mean values of the spread at 20 °C ambient temperature in a cold state. Tripping time depends on response current. When the devices are at operational temperature the tripping time of the overload relay reduces to approx. 25 % of the read off value. Specific characteristics for each individual setting range can be found in the manual on → Page 6/18

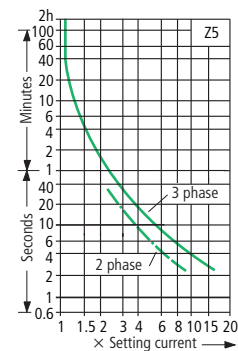
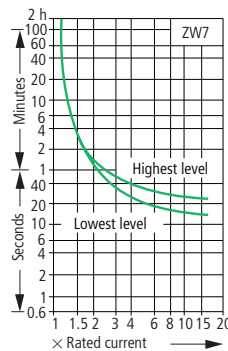
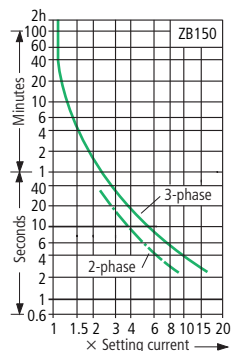
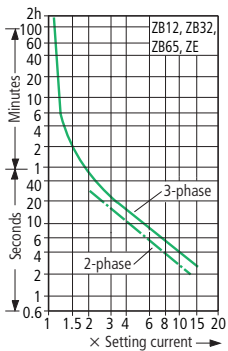

			ZE	ZB12, ZB32	ZB65	ZB150(KK)
General						
Standards			IEC/EN 60947, VDE 0660, UL, CSA			
Climatic proofing			Damp heat, constant, to IEC 60068-2-78; Damp heat, cyclic, to IEC 60068-2-30			
Ambient temperature						
Open ¹⁾		°C	-25...50	-25...55	-25...55	-25...55
Enclosed ¹⁾		°C	-25...40	-25...40	-25...40	-25...40
Temperature compensation			Continuous			
Mounting position			→ Engineering selection data			
Weight			0.07	0.15	0.25	1.64
Mechanical shock resistance half-sinusoidal shock 10 ms to IEC 60068-2-27		g	10	10	10	10
Protection type			IP20	IP 20	IP00	IP00
Protection against direct contact when actuated from front (IEC 536)			Finger- and back-of-hand proof			
Main conducting paths						
Rated impulse withstand voltage	U_{imp}	V AC	6000	6000	6000	8000
Overvoltage category/pollution degree			III/3	III/3	III/3	III/3
Rated insulation voltage						
AC	U_i	V AC	690	690	690	1000
Rated operational voltage	U_e	V AC	690	690	690	1000
Safe isolation to VDE 0106 Part 101 and Part 101/A1						
Between auxiliary contacts and main contacts		V AC	300	440	440	440
Between main circuits		V AC	300	440	440	440
Overload release setting range		A	0.1...9	0.1...32	6...75	25...150
Temperature compensation residual error > 40°C		%/K	≤ 0.25	≤ 0.25	≤ 0.25	≤ 0.25
Short-circuit protection Maximum fuse			→ page 6/5	→ page 6/7	→ page 6/9	→ page 6/9
Current heat loss (3 conductors)						
Lower value of the setting range		W	2.5	2.5	3	16
Maximum setting		W	6	6	7.5	18
Terminal capacities						
Solid		mm ²	2 × (0.75 – 2.5)	2 × (1 – 6)	2 × (1 – 16) ⁴⁾	2 × (4 – 16)
Flexible with ferrule		mm ²	2 × (0.5 – 1.5)	2 × (1 – 4) 2 × (1 – 6) ³⁾	1 × (1...25) 2 × (1...10) ²⁾	1 × (4 – 70) 2 × (4 – 50)
Stranded		mm ²			1 × (16...25)	1 × (16...50) 2 × (16...50)
Solid or stranded		AWG	18 – 14	14 – 8	14 – 2	2/0
Terminal screw			M3.5	M4	M6	M10
Tightening torque		Nm	1.2	1.8	3.5	10
Tools						
Pozidriv screwdriver		Size	2	2	2	–
Standard screwdriver		mm	0.8 × 5.5	1 × 6	1 × 6	
Hexagon socket-head spanner	SW	mm	–	–	–	5

Notes

¹⁾ Ambient temperature: Operating range to IEC/EN 60947, PTB: -5°C to +55°C

²⁾ Main contacts terminal capacity solid and stranded conductors with ferrules: When using 2 conductors use identical cross-section

³⁾ 6 mm² flexible with ferrules to DIN 46228

⁴⁾ at ZB65-XEZ max 1 × (1...16)



Overload relay, CT-operated overload relay

http://catalog.moeller.net

Moeller HPL0211-2007/2008

Z5, ZW7

			Z5-.../FF250	ZW7	
General					
Standards			IEC/EN 60947, VDE 0660, UL, CSA		
Climatic proofing			Damp heat, constant, to IEC 60068-2-78; Damp heat, cyclic, to IEC 60068-2-30		
Ambient temperature					
Open ¹⁾		°C	-25...50	-25...50	
Enclosed ¹⁾		°C	-25...40	-25...40	
Temperature compensation			Continuous		
Mounting position			→ Engineering selection data		
Weight			1.55		
Mechanical shock resistance half-sinusoidal shock 10 ms to IEC 60068-2-27			10		
Protection type			IP00		
Protection against direct contact when actuated from front (IEC 536)			With terminal cover		
			Finger- and back-of-hand proof		
Main conducting paths					
Rated impulse withstand voltage		U_{imp}	V AC	8000	6000
Overvoltage category/pollution degree			III/3		
Rated insulation voltage					
AC		U_i	V AC	1000	690
Rated operational voltage		U_e	V AC	1000	690
Safe isolation to VDE 0106 Part 101 and Part 101/A1					
Between auxiliary contacts and main contacts			V AC	440	440
Between main circuits			V AC	440	440
Overload release setting range			A		
Temperature compensation residual error > 40°C			%/K	≤ 0.25	-
Short-circuit protection Maximum fuse			→ page 6/11		
			With overload relay in conjunction with a transformer as required for the contactor		
Current heat loss (3 conductors)					
Lower value of the setting range			W	16	3
Maximum setting			W	28	10
Terminal capacities					
Flexible with cable lug			mm ²	95	-
Stranded with cable lug			mm ²	120	-
Solid or stranded			AWG	250 MCM	-
Flat conductor	Number of segments × width × thickness		mm	6 × 16 × 0.8 ²⁾	-
Busbar	Width		mm	20 × 3	-
Push-through opening			mm		
Terminal screw			M8 × 25		
Tightening torque			Nm		
Tools					
Hexagon head spanner		SW	mm	13	-

Notes

- ¹⁾ Ambient temperature: operating range to IEC/EN 60947, PTB: -5°C to +50°C
- ²⁾ Flat conductor terminal capacity: fixing with box terminal



				ZE	ZB12, ZB32	Z5-.../FF250	ZW7
Auxiliary and control circuits							
Rated impulse withstand voltage	U_{imp}	V		6000	6000	6000	6000
Overvoltage category/pollution degree				III/3	III/3	III/3	III/3
Terminal capacities							
Solid		mm ²		2 × (0.75 – 2.5)	2 × (0.75...4)	2 × (0,75 – 4)	2 × (0.75 – 4)
Flexible with ferrule		mm ²		2 × (0.5 – 1.5)	2 × (0.75 – 2.5)	2 × (0,75 – 2,5)	2 × (0.75 – 2.5)
Solid or stranded		AWG		2 × (18 – 12)	2 × (18 – 12)	2 × (18 – 12)	2 × (18 – 12)
Terminal screw				M3.5	M3.5	M3.5	M3.5
Tightening torque		Nm		0.8 – 1.2	0.8 – 1.2	0.8 – 1.2	0.8 – 1.2
Tools							
Pozidriv screwdriver		Size		2	2	2	2
Standard screwdriver		mm		0.8 × 5.5	1 × 6	1 × 6	1 × 6
Rated insulation voltage	U_i	V AC		690	500	500	500
Rated operational voltage	U_e	V AC		500	500	500	500
Safe isolation to VDE 0106 Part 101 and Part 101/A1							
		V AC		300	240	240	240
Conventional thermal current	I_{th}	A		6	6	6	6
Rated operational current							
AC-15							
Make contact							
120 V	I_e	A		1.5	1.5	1.5	1.5
240 V	I_e	A		1.5	1.5	1.5	1.5
415 V	I_e	A		0.5	0.5	0.5	0.5
500 V	I_e	A		0.3	0.5	0.5	0.5
Break contact							
120 V	I_e	A		1.5	1.5	1.5	1.5
240 V	I_e	A		1.5	1.5	1.5	1.5
415 V	I_e	A		0.7	0.9	0.9	0.9
500 V	I_e	A		0.5	0.8	0.8	0.8
DC-13 L/R – 15 ms ¹⁾							
24 V	I_e	A		0.9	0.9	0.9	0.9
60 V	I_e	A		0.75	0.75 ³⁾	0.75 ³⁾	0.75 ³⁾
110 V	I_e	A		0.4	0.4	0.4	0.4
220 V	I_e	A		0.2	0.2	0.2	0.2
Short-circuit rating without welding							
		A gG/gL A gG/gL		4	6	6	6

Notes

- ¹⁾ Rated operational current: Making and breaking conditions to DC-13, L/R constant as stated
- ²⁾ See overlay: "Fuses" for short-circuit rating time/current characteristic (please enquire)
- ³⁾ Rated operational current DC-13, 60 V: N/O auxiliary contact 0.6 A



Electronic motor-protective relay

http://catalog.moeller.net

Moeller HPL0211-2007/2008

ZEV

				ZEV		
General						
Standards				IEC/EN 60947, VDE 0660, UL, CSA		
Climatic proofing				Damp heat, constant, to IEC 60068-2-78; Damp heat, cyclic, to IEC 60068-2-30		
Ambient temperature	Open ¹⁾		°C	25...60 ⁸⁾		
		Enclosed ¹⁾	°C	25...40 ⁸⁾		
		Storage	°C	-40...80		
Temperature compensation				Continuous		
Mounting position				As required		
Weight				kg 0.257		
Mechanical shock resistance half-sinusoidal shock 10 ms to IEC 60068-2-27				g 15		
Protection type				IP20		
Protection against direct contact when actuated from front (IEC 536)				Finger- and back-of-hand proof		
Main conducting paths						
Overload release setting range				A 1...820 ⁷⁾		
Temperature compensation residual error > 40°C				%/K -		
Short-circuit protection Maximum fuse ³⁾				With overload relay in conjunction with a transformer as required for the contactor		
Tools	Pozidriv screwdriver		Size	1		
	Standard screwdriver		mm	0.8 × 5.5		
Auxiliary and control circuits						
Rated impulse withstand voltage				U_{imp} V 4000		
Overvoltage category/pollution degree				III/3		
Terminal capacities	Solid		mm ²	1 × (0.5 – 2.5) 2 × (0.5 – 1.5) ⁴⁾		
		Flexible with ferrule	mm ²	1 × (0.5 – 2.5) 2 × (0.5 – 1.5) ⁴⁾		
		Solid or stranded	AWG	1 × (18 – 14)		
Terminal screw				M3.5		
Tightening torque				Nm 0.8		
Tools	Pozidriv screwdriver		Size	1		
	Standard screwdriver		mm	0.8 × 5.5		
Rated insulation voltage				U_i V AC 250		
Rated operational voltage				U_e V AC 240		
Safe isolation to VDE 0106 Part 101 and Part 101/A1 between the auxiliary contacts				V AC 240 ⁵⁾		
Conventional thermal current				I_{th} A 6		
Rated operational current AC-15	Make contact	120 V	I_e A	3 ⁶⁾		
			240 V	I_e A	3 ⁶⁾	
			415 V	I_e A	-	
		500 V	I_e A	-		
			Break contact	120 V	I_e A	3
				240 V	I_e A	3
	DC-13 L/R – 15 ms ²⁾	24 V	I_e A	-		
			60 V	I_e A	-	
			110 V	I_e A	-	
		220 V	I_e A	-		
			I_e A	-		
			I_e A	-		
	Power consumption				$P_{max.}$ W 2.5	
	Short-circuit rating without welding max. fuse ³⁾				A gG/gL 6	
Voltage tolerance				AC operated	× U_c 0.85...1.1	
				DC operated	× U_c 0.85...1.1	
Thermistor protection						
Total resistance (cold)				Ω 1500		
Response value				Ω 2720...3680		
Reset range				Ω 1500...1650		
Recovery time	Overload			→ page 6/15		
	Thermistor tripping			5 K below response temperature		
	Earth-fault protection			immediate		

Notes

- 1) Ambient temperature: open and enclosed operating range to IEC/EN 60947, PTB: -5°C to +50°C
- 2) Rated operational current: Making and breaking conditions to DC-13, L/R constant as stated
- 3) See overlay: "Fuses" for short-circuit rating time/current characteristic (please enquire)
- 4) Terminal capacities auxiliary and control circuits, solid, flexible with ferrules: With connection of 2 conductors only the following combinations are permissible: 0.5 and 0.75 mm², 0.75 and 1 mm², 1 and 1.5 mm²
- 5) Safe isolation: Up to 240 V depending on contact assignment between mains and outputs no potential isolation to thermistor and summation current transformer input and current sensor (neighbouring contacts: $U_s = 127 V$)
- 6) Rated operational current AC-15: contacts 95/96 and 97/98 3 A (contactor control), contacts 05/06 and 07/08 1.5 A (auxiliary contacts)
- 7) Overload relay main contact setting range: setting range dependant on current sensor
- 8) Main contacts terminal capacity solid and stranded conductors with ferrules: When using 2 conductors use identical cross-section
Ambient temperature open and enclosed: limited readability of the LCD display at < -15 °C



ZEV			ZEV-XSW-25	ZEV-XSW-65	ZEV-XSW-145	ZEV-XSW-820
General						
Standards			IEC/EN 60947, VDE 0660, UL, CSA			
Climatic proofing			Damp heat, constant, to IEC 60068-2-78; Damp heat, cyclic, to IEC 60068-2-30			
Ambient temperature ¹⁾						
Open		°C	25...60	25...60	25...60	25...60
Enclosed		°C	25...40	25...40	25...40	25...40
Storage		°C	-40...80	-40...80	-40...80	-40...80
Temperature compensation			Continuous			
Mounting position			As required			
Weight		kg	0.23	0.4	0.45	0.14
Mechanical shock resistance half-sinusoidal shock 10 ms to IEC 60068-2-27		g	15	15	15	15
Protection type			IP20	IP20	IP20	IP20
Protection against direct contact when actuated from front (IEC 536)			Finger- and back-of-hand proof			
Main conducting paths						
Rated impulse withstand voltage	U_{imp}	V AC	2)	2)	2)	8000
Overtoltage category/pollution degree			2)	2)	2)	III/3
Rated insulation voltage						
AC	U_i	V AC	2)	2)	2)	1000
Rated operational voltage	U_e	V AC	2)	2)	2)	1000
Safe isolation to VDE 0106 Part 101 and Part 101/A1						
Between busbar and sensor		V AC	—	—	—	500
Overload release setting range		A	1...25	3...65	10...145	40...820
Short-circuit protection Maximum fuse			With overload relay in conjunction with a transformer as required for the contactor			
Push-through opening		mm	6	13	21	110

Notes

¹⁾ Operating range to IEC/EN 60947, PTB: -5°C to +50°C

²⁾ The main current parameters are defined by the main current wiring which is used.



Thermistor overload relays for machine protection

http://catalog.moeller.net

Moeller HPL0211-2007/2008

EMT6

				EMT6
General				
Standards				IEC/EN 60947, VDE 0660, EN 55011
Climatic proofing				Damp heat, constant, to IEC 60068-2-78; Damp heat, cyclic, to IEC 60068-2-30
Ambient temperature				
Open		°C		-25...60
Enclosed		°C		-25...45
Storage		°C		-45...60
Mounting position				As required
Weight		kg		0.15
Mechanical shock resistance half-sinusoidal shock 10 ms to IEC 60068-2-27		g		10
Protection type				IP20
Protection against direct contact when actuated from front (IEC 536)				Finger- and back-of-hand proof
Safe isolation to VDE 0106 Part 101 and Part 101/A1				
between the contacts		V AC		250
between contacts and power supply		V AC		250
Auxiliary and control circuits				
Rated impulse withstand voltage	U_{imp}	V AC		6000
Overvoltage category/pollution degree				III/3
Terminal capacities Auxiliary and control circuits				
Solid		mm ²		1 × 2.5 2 × (0.5 – 1.5)
Flexible with ferrule		mm ²		1 × 2.5 2 × (0.5 – 1.5)
Solid or stranded		AWG		20 – 14
Terminal screw				M3.5
Tightening torque		Nm		1.2
Tools				
Pozidriv screwdriver		Size		2
Standard screwdriver		mm		1 × 6
Auxiliary power circuit				
Rated insulation voltage	U_i	V		400
Rated operational current				
AC-14				
Make contact				
415 V	I_e	A		3
Break contact				
415 V	I_e	A		3
AC-15				
Make contact				
240 V	I_e	A		3
415 V	I_e	A		1
Break contact				
240 V	I_e	A		3
415 V	I_e	A		1
Max. short-circuit protective device				
Fuse	gG/gL	A		6
Control circuit				
Rated insulation voltage	U_i	V		240
Rated operational voltage	U_e	V		240 ¹⁾
Pick-up and drop-out values		× U_e		0.85 – 1.1
Power consumption				
AC		VA		3.5
DC		W		2
Trip at approx.		Ω		3600
Recovery at approx.		Ω		1600

Notes

¹⁾ EMT6(-DB)230V: $U_e = 230$ V



ZE, ZB

Moeller HPL0211-2007/2008

<http://catalog.moeller.net>

Overload relay

ZE

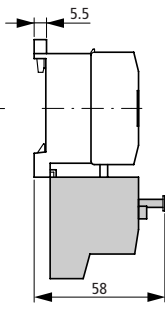
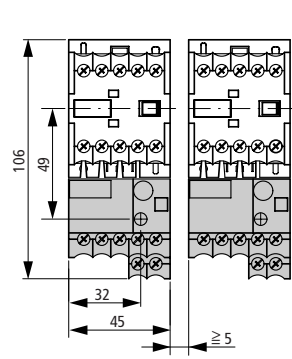

Base

ZB32-XEZ

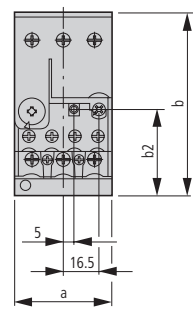

ZB65-XEZ

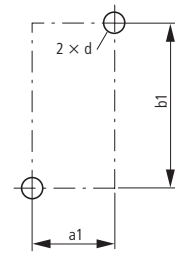
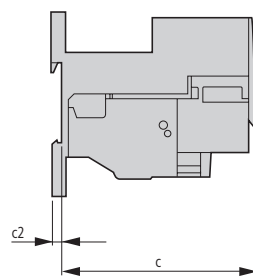

Part no.	ZB32	ZB65
a	45	60
b	85	86
c	90.5	112
c2	3.8	4.7
a1	35	50
b1	75	75
b2	40.5	47
d	M4	M5

ZB12

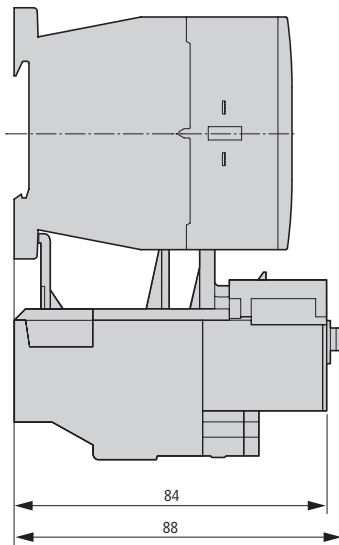
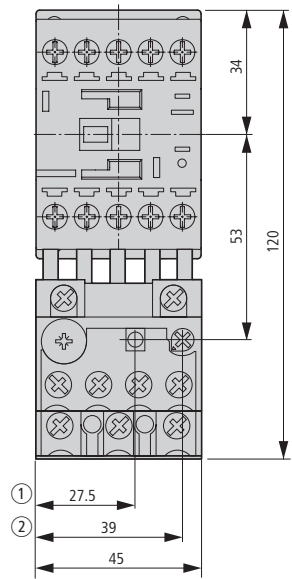

ZB32

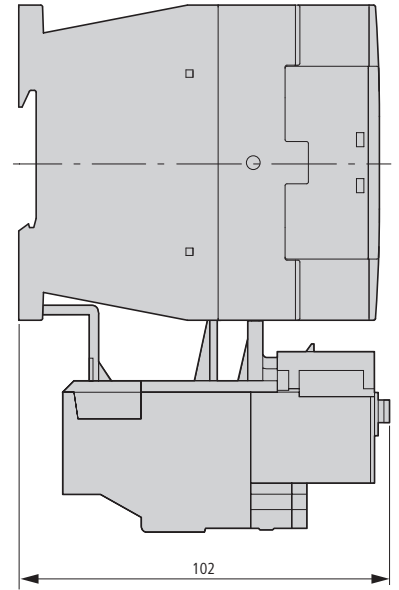
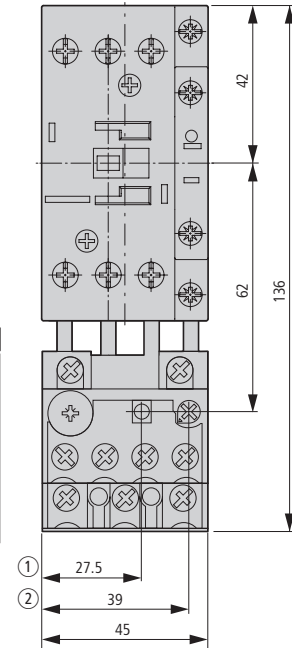

- ① OFF
- ② Reset/ON

ZB65

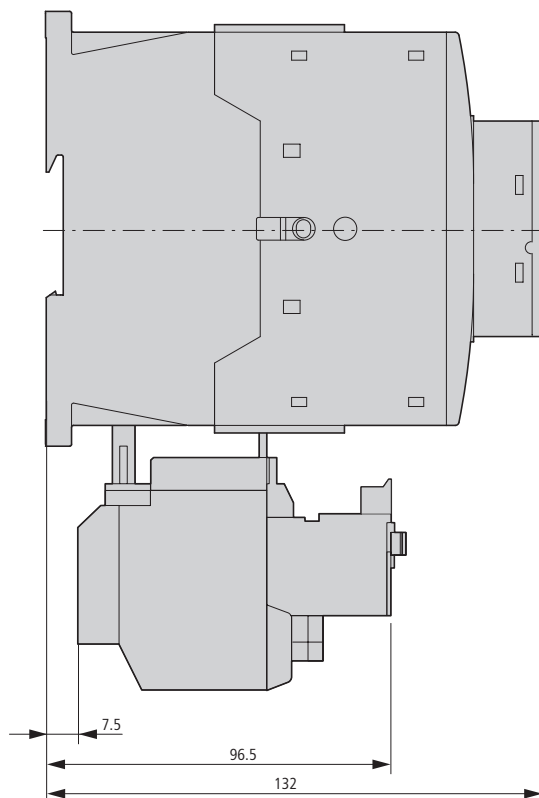
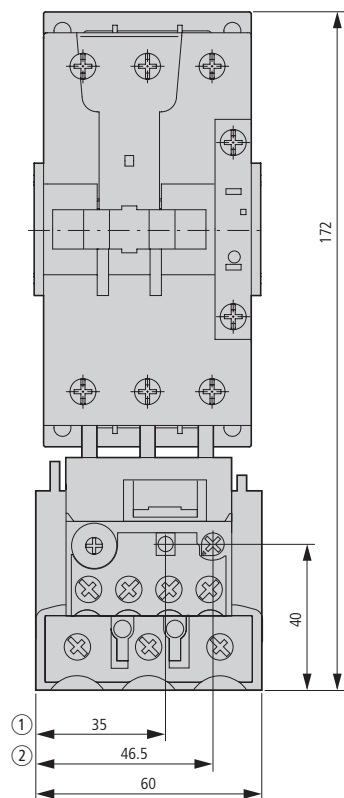

- ① OFF
- ② Reset/ON

Overload relay

ZB150

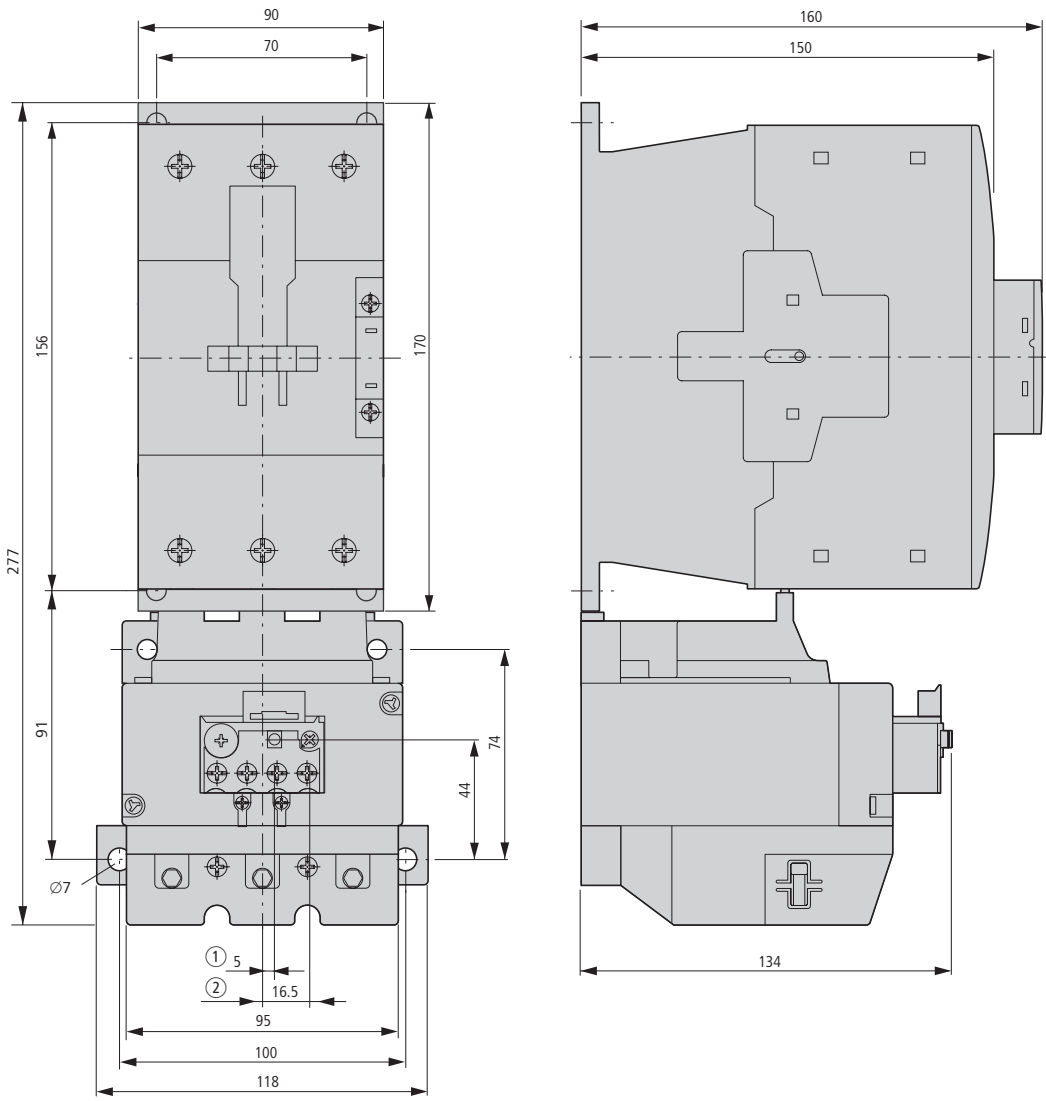

ZB150KK

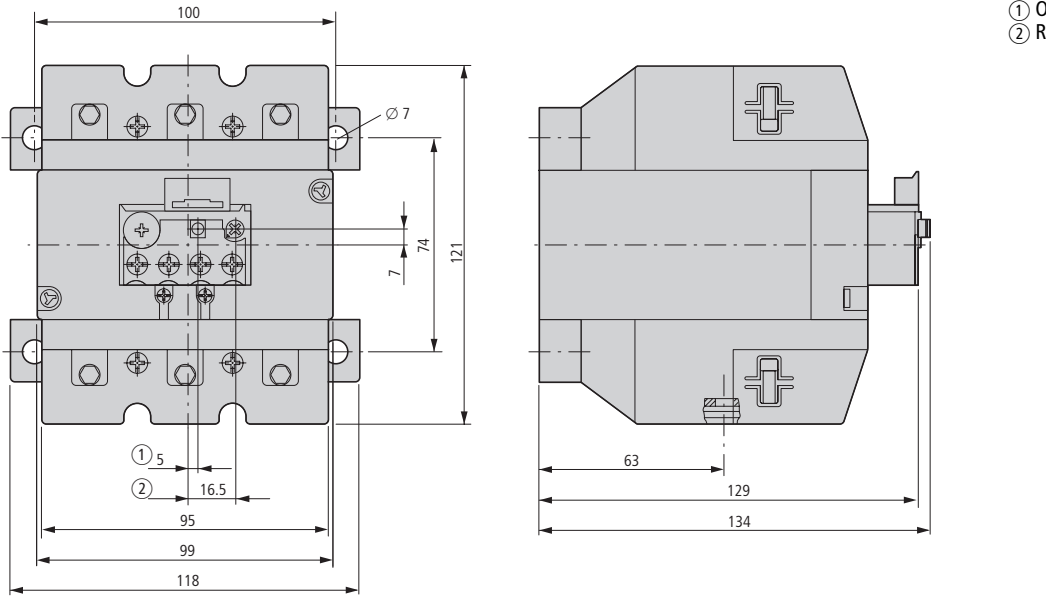

Overload relays



Overload relay greater than 150 A
Z5-.../FF250

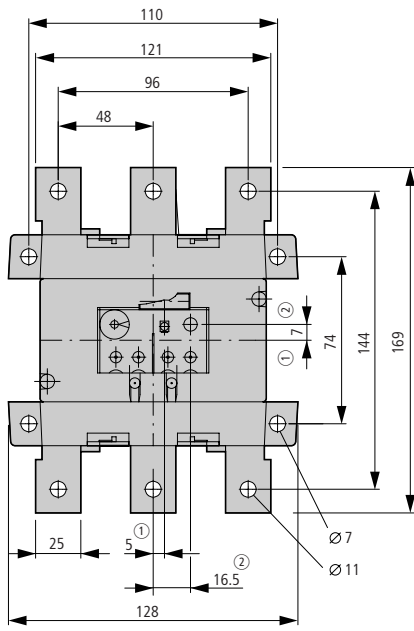

- ① OFF
- ② Reset/ON

Current transformer-operated overload relay
ZW7

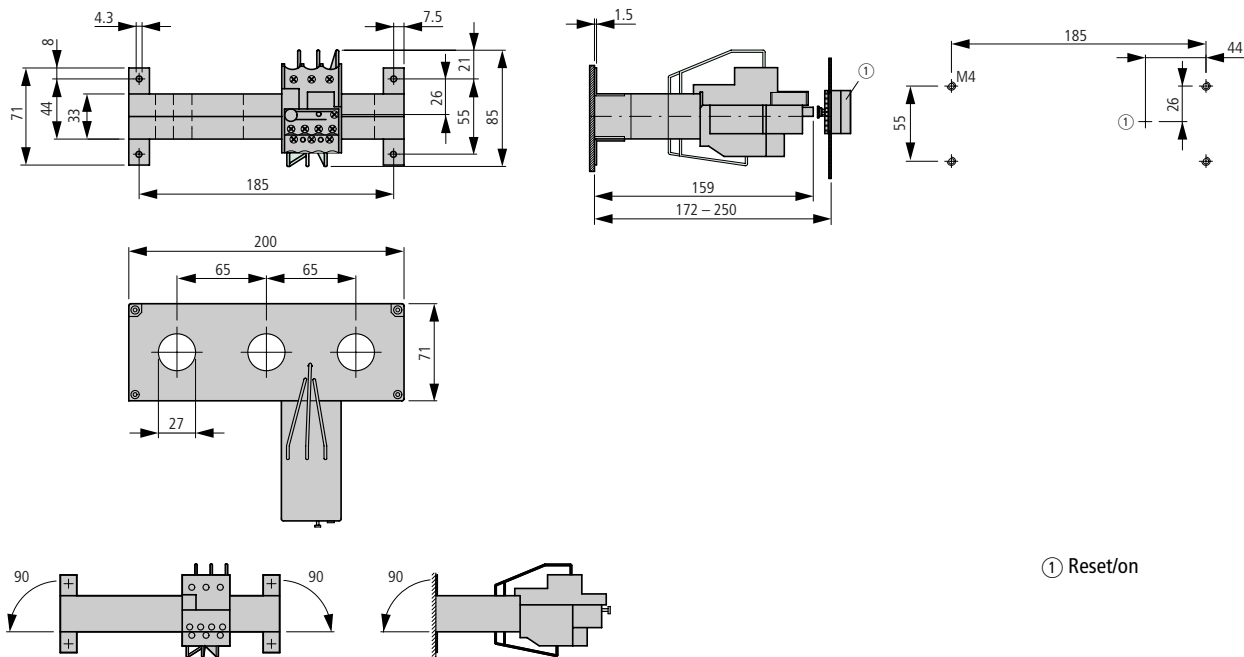

Thermistor overload relays for machine protection

EMT6...

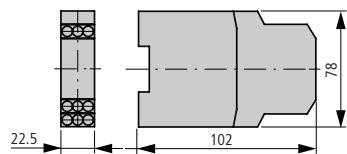

External reset button
Off button

M22-DZ-B
M22-DZ-X

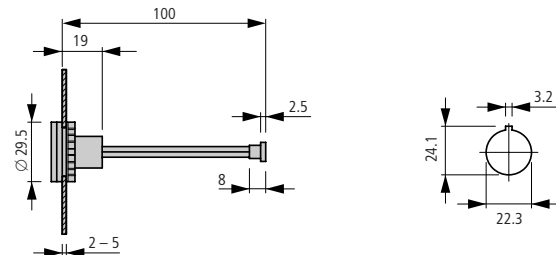

Electronic motor-protective relay

http://catalog.moeller.net

Moeller HPL0211-2007/2008

ZEV

Electronic motor-protective relay

ZEV

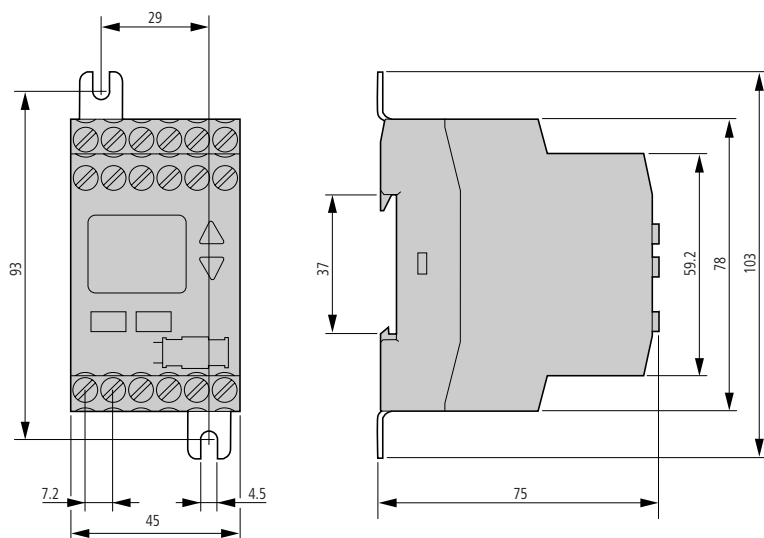

Electronic motor-protective relay

ZEV + ZEV-XSW-...

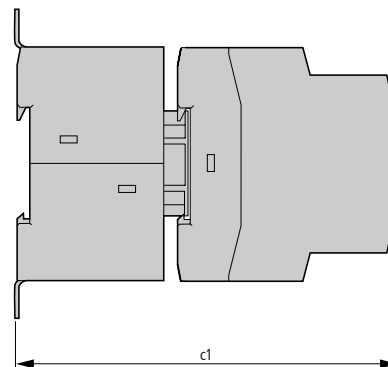

Part no.	c1
ZEV + ZEV-XSW-25	120
ZEV + ZEV-XSW-65	128
ZEV + ZEV-XSW-145	134

Current sensors

ZEV-XSW-...

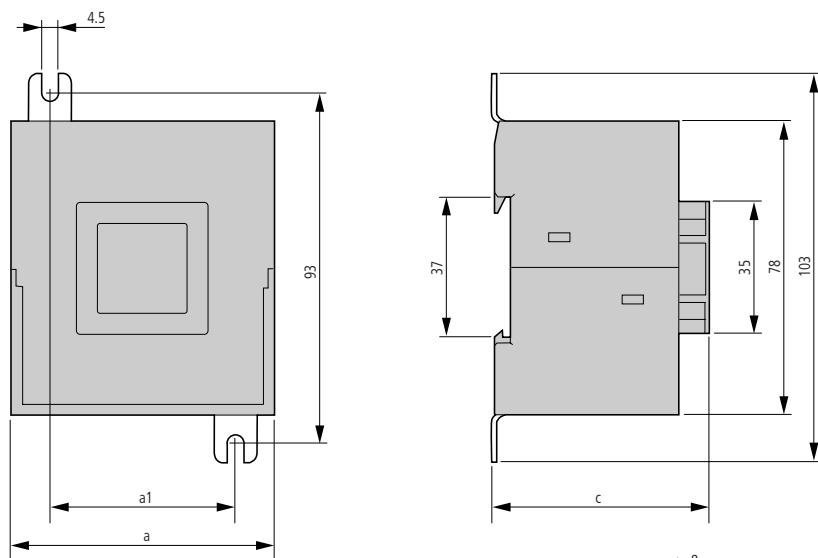

Référence	a	a1	c	d1	d2
ZEV + ZEV-XSW-25	45	24	50	6	11.2
ZEV + ZEV-XSW-65	70	49	58	13	19
ZEV + ZEV-XSW-145	90	68	65	21	26

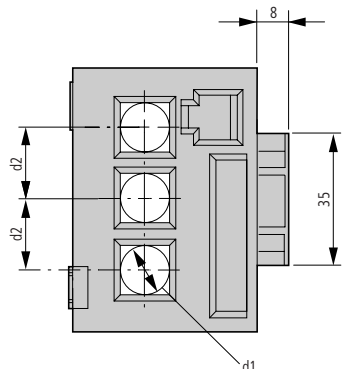

Current sensors

ZEV-XSW-820

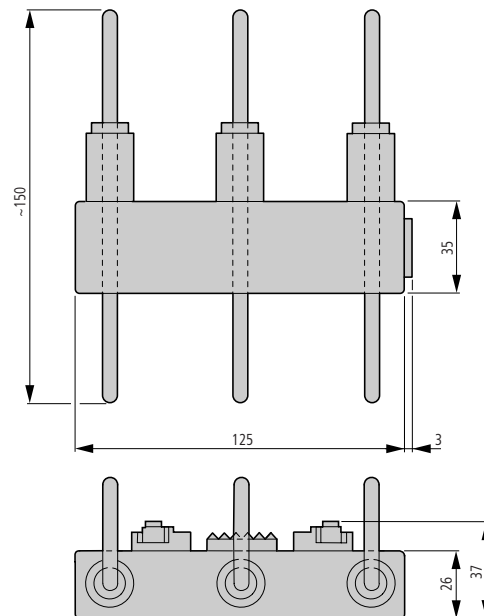

Core-balance transformer

SSW...

Part no.	a	a1	a2	b	b1	c	d	e
SSW40-...	64	50	38	100	80	86	4.5	40
SSW65-...	75	60	43	124	100	112	4.5	65
SSW120-...	86.5	70	54.5	200	170	205	4.5	120

