



# DS60-N41311

Dx60

MID RANGE DISTANCE SENSORS

**SICK**  
Sensor Intelligence.



## Ordering information

Type	Part no.
DS60-N41311	1016690

Other models and accessories → [www.sick.com/Dx60](http://www.sick.com/Dx60)



## Detailed technical data

### Performance

<b>Measuring range</b>	80 mm ... 6,000 mm, 90 % remission <sup>1)</sup> 80 mm ... 5,000 mm, 18 % remission <sup>1)</sup> 80 mm ... 2,600 mm, 6 % remission <sup>1)</sup>
<b>Response time</b>	50 ms
<b>Switching frequency</b>	10 Hz
<b>Light source</b>	Laser, infrared
<b>Laser class</b>	1 (EN 60825-1)
<b>Typ. light spot size (distance)</b>	12 mm x 12 mm (at 6 m)
<b>Additional function</b>	Invertable switching output
<b>Average laser service life (at 25 °C)</b>	50,000 h

<sup>1)</sup> Teach-in from 200 ... 6,000 mm.

### Interfaces

<b>Switching output</b>	2x NPN (100 mA) <sup>1) 2)</sup>
-------------------------	----------------------------------

<sup>1)</sup> Output Q short-circuit protected.

<sup>2)</sup> NPN: HIGH = < 2.5 V / LOW = V<sub>S</sub>.

### Mechanics/electronics

<b>Supply voltage V<sub>s</sub></b>	DC 18 V ... 30 V <sup>1)</sup>
<b>Ripple</b>	≤ 5 V <sub>pp</sub> <sup>2)</sup>
<b>Power consumption</b>	≤ 3 W <sup>3)</sup>
<b>Connection type</b>	Male connector, M12, 5-pin
<b>Weight</b>	202 g
<b>Enclosure rating</b>	IP 67

<sup>1)</sup> Limit values, reverse-polarity protected, operation in short-circuit protected network: max. 8 A.

<sup>2)</sup> May not fall short of or exceed V<sub>S</sub> tolerances.

<sup>3)</sup> Without load.

<b>Protection class</b>	II
-------------------------	----

- 1) Limit values, reverse-polarity protected, operation in short-circuit protected network: max. 8 A.
- 2) May not fall short of or exceed  $V_S$  tolerances.
- 3) Without load.

**Ambient data**

<b>Electromagnetic compatibility (EMC)</b>	EN 61000-6-2 EN 60947-5-2
<b>Ambient temperature</b>	Operation: -25 °C ... +55 °C Storage: -25 °C ... +75 °C

**Classifications**

<b>ECl@ss 5.0</b>	27270801
<b>ECl@ss 5.1.4</b>	27270801
<b>ECl@ss 6.0</b>	27270801
<b>ECl@ss 6.2</b>	27270801
<b>ECl@ss 7.0</b>	27270801
<b>ECl@ss 8.0</b>	27270801
<b>ECl@ss 8.1</b>	27270801
<b>ECl@ss 9.0</b>	27270801
<b>ETIM 5.0</b>	EC001825
<b>ETIM 6.0</b>	EC001825
<b>UNSPSC 16.0901</b>	41111613

**Dimensional drawing** (Dimensions in mm (inch))

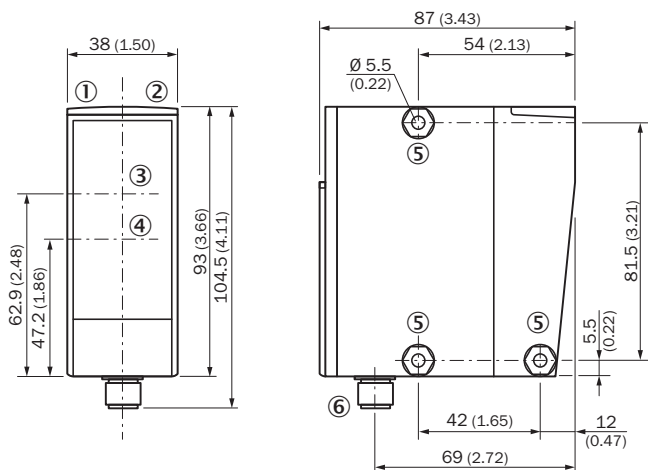

- ① Status indicator switching output 1
- ② Status indicator switching output 2
- ③ Optical axis sender
- ④ Optical axis receiver
- ⑤ Mounting hole,  $\varnothing$  5.2 mm
- ⑥ Male connector M12, 5-pin

## Connection type

Male connector M12, 5-pin

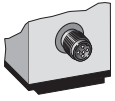

## Connection diagram



## Adjustment possible

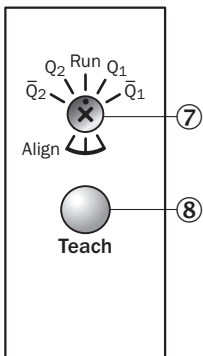

- ⑦ Rotary switch
- ⑧ Control element

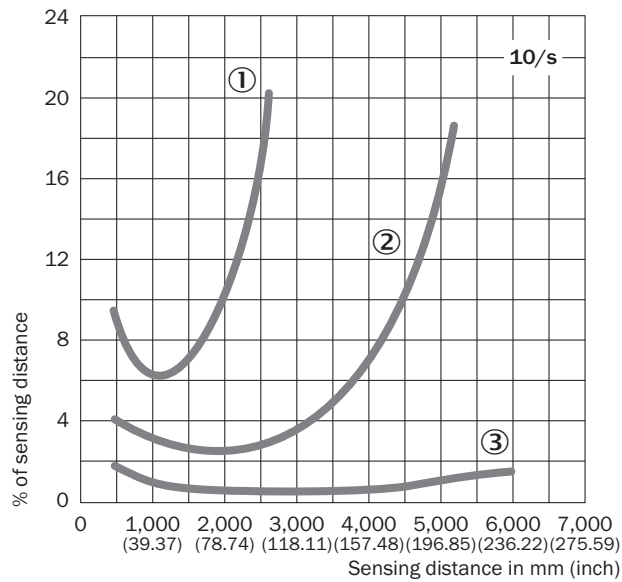

## Sensing distance



- ① 6 % / 90 %
- ② 18 % / 90 %
- ③ 90 % / 90 %

## Recommended accessories

Other models and accessories → [www.sick.com/Dx60](http://www.sick.com/Dx60)

	Brief description	Type	Part no.
<b>Mounting brackets and plates</b>			
	Mounting bracket, steel, zinc coated, without mounting hardware	BEF-WN-DS60	4032937
<b>Plug connectors and cables</b>			
	Head A: female connector, M12, 5-pin, straight Head B: cable Cable: PVC, unshielded, 2 m	DOL-1205-G02M	6008899
	Head A: female connector, M12, 5-pin, straight Head B: cable Cable: PVC, unshielded, 5 m	DOL-1205-G05M	6009868
	Head A: female connector, M12, 5-pin, straight Head B: cable Cable: PVC, unshielded, 10 m	DOL-1205-G10M	6010544
	Head A: female connector, M12, 5-pin, angled Head B: cable Cable: PVC, unshielded, 2 m	DOL-1205-W02M	6008900
	Head A: female connector, M12, 5-pin, angled Head B: cable Cable: PVC, unshielded, 5 m	DOL-1205-W05M	6009869

1) Customizable length by sheet. Width max. 74.9 cm, length max. 91.4 cm.

	Brief description	Type	Part no.
	Head A: female connector, M12, 5-pin, angled Head B: cable Cable: PVC, unshielded, 10 m	DOL-1205-W10M	6010542
Reflectors			
	"Diamond grade" reflective tape, self-adhesive, ready to assemble from the sheet, 74.9 cm x 91.4 cm <sup>1)</sup> , self-adhesive	REF-DG-K	4019634

<sup>1)</sup> Customizable length by sheet. Width max. 74.9 cm, length max. 91.4 cm.

## SICK AT A GLANCE

SICK is one of the leading manufacturers of intelligent sensors and sensor solutions for industrial applications. A unique range of products and services creates the perfect basis for controlling processes securely and efficiently, protecting individuals from accidents and preventing damage to the environment.

We have extensive experience in a wide range of industries and understand their processes and requirements. With intelligent sensors, we can deliver exactly what our customers need. In application centers in Europe, Asia and North America, system solutions are tested and optimized in accordance with customer specifications. All this makes us a reliable supplier and development partner.

Comprehensive services complete our offering: SICK LifeTime Services provide support throughout the machine life cycle and ensure safety and productivity.

For us, that is “Sensor Intelligence.”

## WORLDWIDE PRESENCE:

Contacts and other locations –[www.sick.com](http://www.sick.com)