



LUTM-UN81162P

LUTM

LUMINESCENCE SENSORS

SICK
Sensor Intelligence.



Ordering information

Type	Part no.
LUTM-UN81162P	1067296

Other models and accessories → www.sick.com/LUTM



Detailed technical data

Features

Dimensions (W x H x D)	12 mm x 31.5 mm x 21 mm
Sensing distance	12.5 mm ¹⁾
Housing design (light emission)	Rectangular
Operating range	8 mm ... 20 mm
Light source	LED, Ultraviolet light ²⁾
Wave length	370 nm
Light emission	Long side
Light spot size	2 mm x 2.5 mm ³⁾
Light spot direction	Vertical
Receiving range	450 nm ... 750 nm
Adjustment	Teach-in button
Teach-in mode	2-point teach-in static/dynamic
Output function	Light/dark switching ⁴⁾

¹⁾ From front edge of lens.

²⁾ Average service life: 100,000 h at T_U = +25 °C.

³⁾ At sensing distance.

⁴⁾ L/D switching via teach-in.

Mechanics/electronics

Supply voltage	12 V DC ... 24 V DC ¹⁾
Ripple	≤ 5 V _{pp} ²⁾

¹⁾ Limit values: DC 12 V (-10 %) ... DC 24 V (+20 %). Operation in short-circuit protected network max. 8 A.

²⁾ May not exceed or fall below U_v tolerances.

³⁾ Without load.

⁴⁾ With light/dark ratio 1:1.

⁵⁾ Signal transit time with resistive load.

⁶⁾ At supply voltage > 24 V, I_{max} = 30 mA. I_{max} is consumption count of all Q_N.

Power consumption	≤ 50 mA ³⁾
Switching frequency	6 kHz ⁴⁾
Response time	80 μs ⁵⁾
Jitter	40 μs
Switching output	NPN
Switching output (voltage)	NPN: HIGH = approx. V _S / LOW ≤ 2 V
Switching output	Light/dark switching
Output current I_{max}	< 100 mA ⁶⁾
Input, teach-in (ET)	NPN Teach: U < 2 V Run: U = 10 V ... < U _V
Connection type	Cable with M12 male connector, 4-pin, 0.2 m
Protection class	III
Circuit protection	U _V connections, reverse polarity protected Output Q short-circuit protected Interference pulse suppression
Enclosure rating	IP67
Weight	70 g
Housing material	ABS

¹⁾ Limit values: DC 12 V (-10 %) ... DC 24 V (+20 %). Operation in short-circuit protected network max. 8 A.

²⁾ May not exceed or fall below U_V tolerances.

³⁾ Without load.

⁴⁾ With light/dark ratio 1:1.

⁵⁾ Signal transit time with resistive load.

⁶⁾ At supply voltage > 24 V, I_{max} = 30 mA. I_{max} is consumption count of all Q_n.

Ambient data

Ambient operating temperature	-10 °C ... +55 °C
Ambient storage temperature	-20 °C ... +75 °C
Shock load	According to IEC 60068
UL File No.	NRKH.E348498 & NRKH7.E348498

Classifications

ECl@ss 5.0	27270908
ECl@ss 5.1.4	27270908
ECl@ss 6.0	27270908
ECl@ss 6.2	27270908
ECl@ss 7.0	27270908
ECl@ss 8.0	27270908
ECl@ss 8.1	27270908
ECl@ss 9.0	27270908
ETIM 5.0	EC001822
ETIM 6.0	EC001822
UNSPSC 16.0901	39121528

Dimensional drawing (Dimensions in mm (inch))

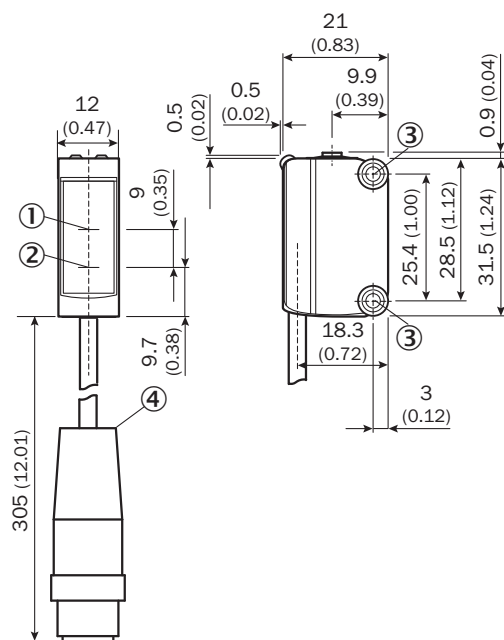

- ① Optical axis receiver
- ② Optical axis sender
- ③ M3 mounting hole
- ④ Cable with male connector

Adjustments

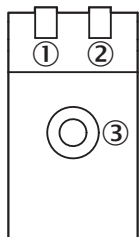

- ① Status indicator LED, yellow: Status switching output Q
- ② LED indicator green: Supply voltage active
- ③ Teach-in button

Connection diagram

Cd-023

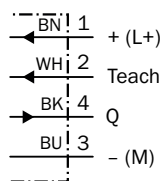

Concept of operation

Setting the switching threshold (dynamic)

1. Position background

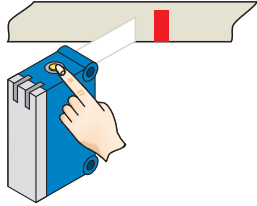

Press the teach-in button and keep it pressed. LED flashing slowly.

2. Move at least the fluorescent mark and background using the light spot.

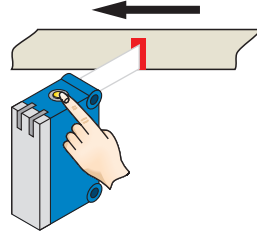

Keep the teach-in button $> 3 < 30$ s pressed.

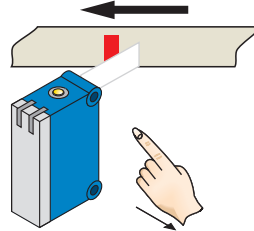

Release the teach-in button.

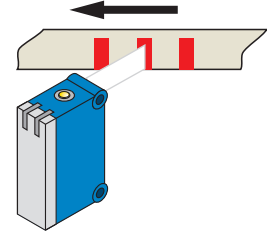

Yellow LED will illuminate, when emitted light is on the fluorescent mark.

Sensitivity setting

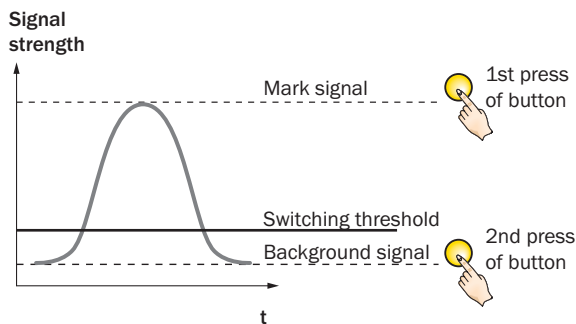

Switching characteristics

Static teach-in: light/dark setting is defined using teach-in sequence.

Dynamic teach-in: switching output active on fluorescent mark, if background is longer in the field of view during the teach-in. The switching threshold is set automatically between the background and the mark.

Teach-in can also be performed using an external control signal (only dynamic teach-in).

Keylock activation and deactivation: hold down teach-in button > 30 s.

Teach-in failure: yellow LED indicator and the transmitted light of the sensor flashing quickly.
For dynamic teach-in with ET signal (5 Hz) via switching output Q.

Setting the switching threshold (static)

1. Position fluorescent mark

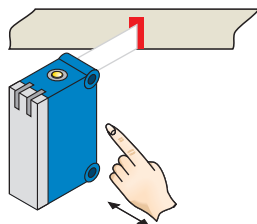

Press and hold teach-in button $> 1 < 3$ s.
Yellow LED flashes slowly.

2. Position background

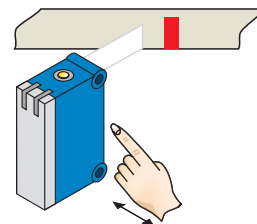





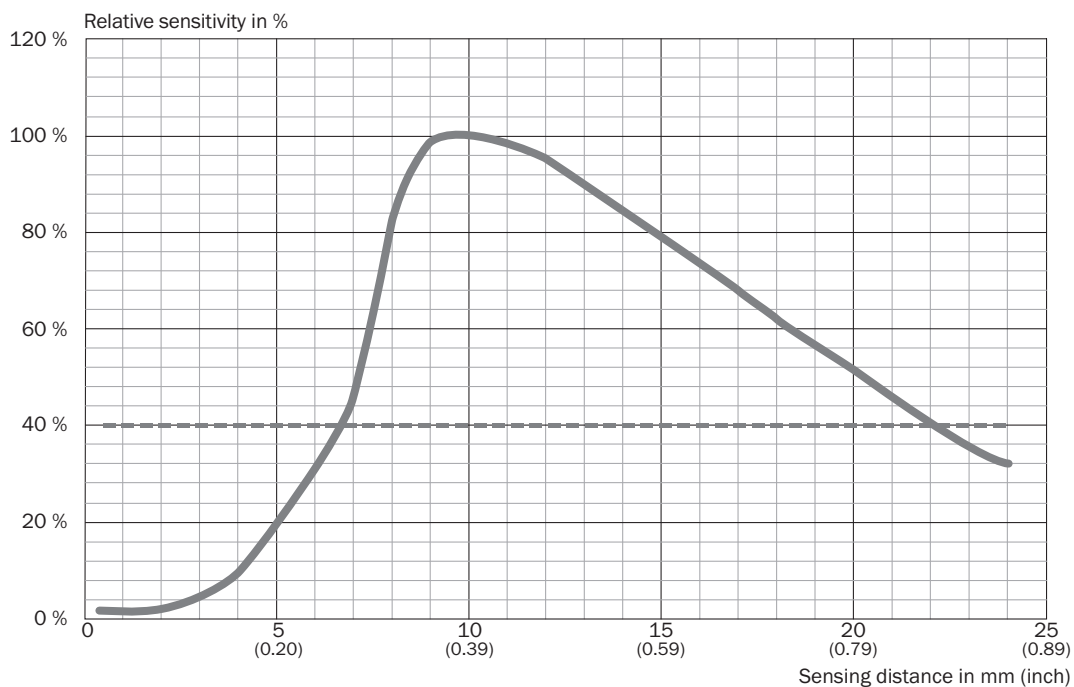



Press and hold teach-in button < 3 s.
Yellow LED goes out.







Characteristic curve



Recommended accessories

Other models and accessories → www.sick.com/LUTM

	Brief description	Type	Part no.
Universal bar clamp systems			
	Universal clamp bracket for rod mounting, steel, zinc coated, without mounting hardware	BEF-KHS-KH1	2022726
	Plate L for universal clamp bracket, steel, zinc coated, universal clamp and mounting hardware included	BEF-KHS-L01	2023057
	Plate N08 for universal clamp bracket, Zinc plated steel (sheet), Zinc die cast (clamping bracket), Universal clamp (5322626), mounting hardware	BEF-KHS-N08	2051607
	Plate N08N for universal clamp bracket, Stainless steel 1.4571 (sheet), Stainless steel 1.4408 (clamp), Universal clamp (5322626), mounting hardware	BEF-KHS-N08N	2051616
	Mounting bar, straight, 200 mm, steel, steel, zinc coated, without mounting hardware	BEF-MS12G-A	4056054
	Mounting bar, straight, 300 mm, steel, steel, zinc coated, without mounting hardware	BEF-MS12G-B	4056055
	Mounting bar, L-shaped, 150 mm x 150 mm, steel, steel, zinc coated, without mounting hardware	BEF-MS12L-A	4056052
	Mounting bar, L-shaped, 250 x 250 mm, steel, steel, zinc coated, without mounting hardware	BEF-MS12L-B	4056053
Device protection (mechanical)			
	Stainless steel 1.4301 (SVS 304), 3 mm thick protective sleeve for G6, stainless steel 1.4301, mounting hardware included	BEF-SG-G6	2069044

	Brief description	Type	Part no.
Mounting brackets and plates			
	Mounting bracket for wall mounting, stainless steel, mounting hardware included	BEF-W100-A	5311520
	Mounting bracket for floor mounting, steel, zinc coated, mounting hardware included	BEF-W100-B	5311521
	Mounting bracket for W100 with specific bore-hole arrangements, steel, zinc coated	BEF-WN-W100-S01	4073866
	Adapter plate KT3 to KTM, steel, zinc coated, fastening screws included	BEF-AP-KTMS01	2068786
Plug connectors and cables			
	Head A: female connector, M12, 4-pin, straight Head B: open cable ends Cable: PVC, unshielded, 2 m	DOL-1204-G02M	6009382
	Head A: female connector, M12, 4-pin, straight Head B: open cable ends Cable: PVC, unshielded, 5 m	DOL-1204-G05M	6009866
	Head A: female connector, M12, 4-pin, angled Head B: open cable ends Cable: PVC, unshielded, 2 m	DOL-1204-W02M	6009383
	Head A: female connector, M12, 4-pin, angled Head B: open cable ends Cable: PVC, unshielded, 5 m	DOL-1204-W05M	6009867
	Head A: female connector, M12, 4-pin, straight Head B: - Cable: unshielded	DOS-1204-G	6007302
	Head A: female connector, M12, 4-pin, angled Head B: - Cable: unshielded	DOS-1204-W	6007303

SICK AT A GLANCE

SICK is one of the leading manufacturers of intelligent sensors and sensor solutions for industrial applications. A unique range of products and services creates the perfect basis for controlling processes securely and efficiently, protecting individuals from accidents and preventing damage to the environment.

We have extensive experience in a wide range of industries and understand their processes and requirements. With intelligent sensors, we can deliver exactly what our customers need. In application centers in Europe, Asia and North America, system solutions are tested and optimized in accordance with customer specifications. All this makes us a reliable supplier and development partner.

Comprehensive services complete our offering: SICK LifeTime Services provide support throughout the machine life cycle and ensure safety and productivity.

For us, that is “Sensor Intelligence.”

WORLDWIDE PRESENCE:

Contacts and other locations –www.sick.com