



RE21-DA05

RE11/RE21/RE31

PRODUCT PORTFOLIO

SICK
Sensor Intelligence.



Ordering information

Type	Part no.
RE21-DA05	6035617

Other models and accessories → www.sick.com/RE11_RE21_RE31



Detailed technical data

Features

System part	Sensor and actuator
Sensor principle	Magnetic
Number of N/O contacts	1
Number of N/C contacts	1
Safe switch on distance S_{ao}	6 mm
Safe switch off distance S_{ar}	31 mm
Actuation directions	5

Safety-related parameters

B_{10d} parameter	2×10^7 switching cycles (with small load)
---------------------------------------	--

Interfaces

Connection type	Cable
Cable length	5 m
Cable material	PVC

Electrical data

Type of output	Reed contacts
Switching voltage	≤ 30 V DC
Switching current	≤ 400 mA

Mechanical data

Design	Rectangular
Dimensions (W x H x D)	25 mm x 88 mm x 13 mm
Weight	0.255 kg
Housing material	Glass-fiber reinforced PPS

Ambient data

Enclosure rating	IP 67
Ambient operating temperature	-20 °C ... +60 °C
Storage temperature	-20 °C ... +60 °C
Vibration resistance	10 Hz ... 55 Hz, 1 mm (EN 60947-5-3)

Shock resistance

30 g, 11 ms (EN 60947-5-3)

Dimensional drawing (Dimensions in mm (inch))

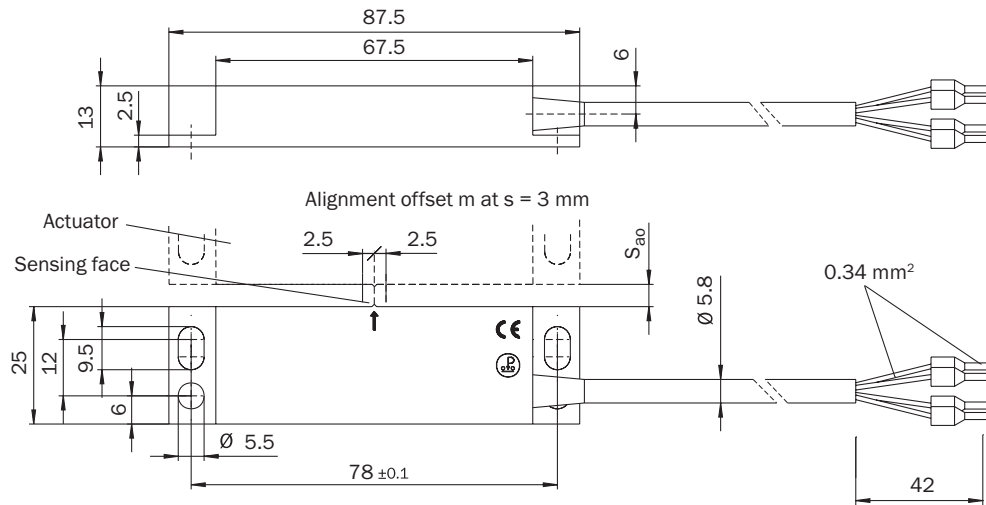

The actuators have the same dimensions as the read heads, but without connecting cable.

Response range

RE21

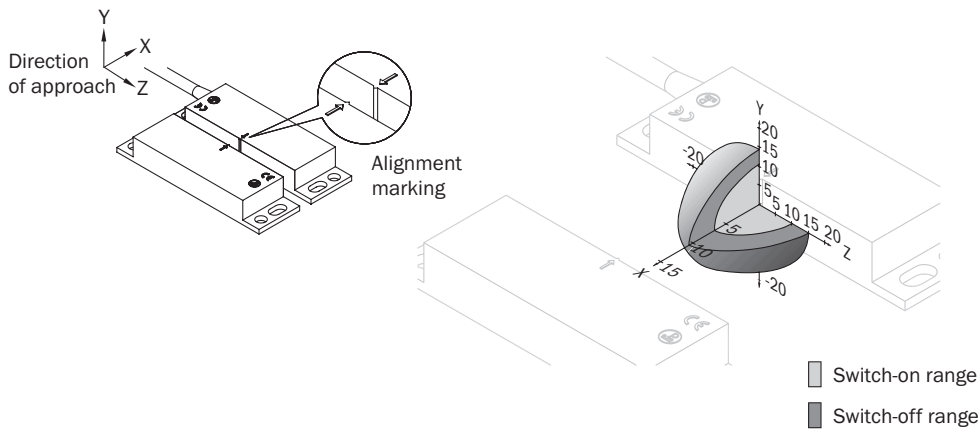

Connection diagram

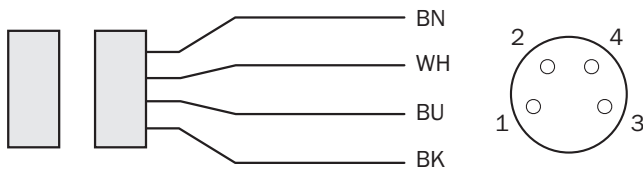

1 BN	N/O contact
2 WH	
3 BU	N/C contact
4 BK	

Sensor timing

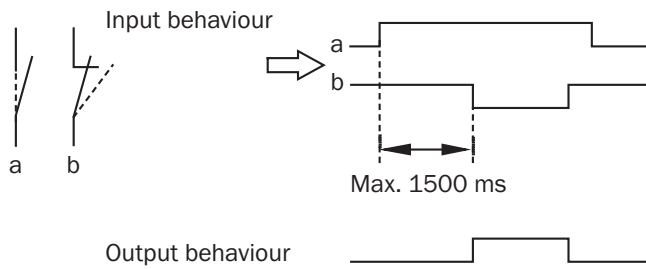

SICK AT A GLANCE

SICK is one of the leading manufacturers of intelligent sensors and sensor solutions for industrial applications. A unique range of products and services creates the perfect basis for controlling processes securely and efficiently, protecting individuals from accidents and preventing damage to the environment.

We have extensive experience in a wide range of industries and understand their processes and requirements. With intelligent sensors, we can deliver exactly what our customers need. In application centers in Europe, Asia and North America, system solutions are tested and optimized in accordance with customer specifications. All this makes us a reliable supplier and development partner.

Comprehensive services complete our offering: SICK LifeTime Services provide support throughout the machine life cycle and ensure safety and productivity.

For us, that is “Sensor Intelligence.”

WORLDWIDE PRESENCE:

Contacts and other locations –www.sick.com