



DGS25-17400100

DGS25

PRODUCT PORTFOLIO

SICK
Sensor Intelligence.

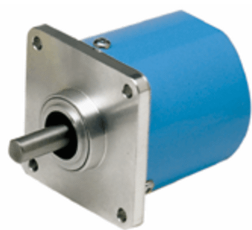

Illustration may differ



Ordering information

Model name	Part no.
DGS25-17400100	7101440

Other models and accessories → www.sick.de/DGS25

Detailed technical data

Technical specifications

Shaft / Flange design	Solid shaft, servo flange
Shaft diameter	3/8"
Number of lines	100
Interface	5 V, TTL
Connection type	Connector, MS, 10-pin, radial
Moment of inertia of the rotor	16.9 gcm ²
Measuring step	90°/number of lines
Reference signal, number	1
Reference signal, position	Gated 180° nominal
Measuring step deviation	45/Z °
Maximum output frequency	≤ 200 kHz
Max. angular acceleration	5 x 10 ⁵ rad/s ²
Start up torque with shaft seal	3.5 Ncm
Start up torque without shaft seal	1.1 Ncm
Permissible shaft loading, axial	178 N
Permissible shaft loading, radial	155 N
Working temperature range	0 °C ... +70 °C
Storage temperature range	-20 °C ... +85 °C
Permissible relative humidity	90%
Resistance to shocks	50/11 g/ms
Resistance to vibration	5/2000 @ 20 g
Protection class according to IEC 60529:	IP 66
Supply voltage	DC, 4.75 V, 5.25 V

Dimensional drawing (Dimensions in mm (inch))

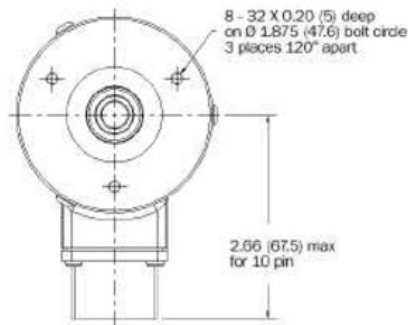
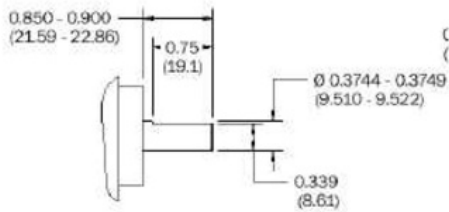
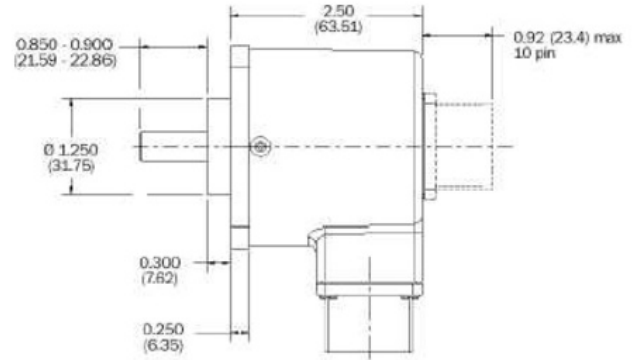

Australia

Phone +61 3 9457 0600
1800 33 48 02 - tollfree
E-Mail sales@sick.com.au

Belgium/Luxembourg

Phone +32 (0)2 466 55 66
E-Mail info@sick.be

Brasil

Phone +55 11 3215-4900
E-Mail marketing@sick.com.br

Canada

Phone +1 905 771 14 44
E-Mail information@sick.com

Česká republika

Phone +420 2 57 91 18 50
E-Mail sick@sick.cz

China

Phone +86 4000 121 000
E-Mail info.china@sick.net.cn
Phone +852-2153 6300
E-Mail ghk@sick.com.hk

Danmark

Phone +45 45 82 64 00
E-Mail sick@sick.dk

Deutschland

Phone +49 211 5301-301
E-Mail info@sick.de

España

Phone +34 93 480 31 00
E-Mail info@sick.es

France

Phone +33 1 64 62 35 00
E-Mail info@sick.fr

Great Britain

Phone +44 (0)1727 831121
E-Mail info@sick.co.uk

India

Phone +91-22-4033 8333
E-Mail info@sick-india.com

Israel

Phone +972-4-6801000
E-Mail info@sick-sensors.com

Italia

Phone +39 02 27 43 41
E-Mail info@sick.it

Japan

Phone +81 (0)3 5309 2112
E-Mail support@sick.jp

Magyarország

Phone +36 1 371 2680
E-Mail office@sick.hu

Nederland

Phone +31 (0)30 229 25 44
E-Mail info@sick.nl

Norge

Phone +47 67 81 50 00
E-Mail sick@sick.no

Österreich

Phone +43 (0)22 36 62 28 8-0
E-Mail office@sick.at

Polska

Phone +48 22 837 40 50
E-Mail info@sick.pl

România

Phone +40 356 171 120
E-Mail office@sick.ro

Russia

Phone +7-495-775-05-30
E-Mail info@sick.ru

Schweiz

Phone +41 41 619 29 39
E-Mail contact@sick.ch

Singapore

Phone +65 6744 3732
E-Mail sales.gsg@sick.com

Slovenija

Phone +386 (0)1-47 69 990
E-Mail office@sick.si

South Africa

Phone +27 11 472 3733
E-Mail info@sickautomation.co.za

South Korea

Phone +82 2 786 6321/4
E-Mail info@sickkorea.net

Suomi

Phone +358-9-25 15 800
E-Mail sick@sick.fi

Sverige

Phone +46 10 110 10 00
E-Mail info@sick.se

Taiwan

Phone +886-2-2375-6288
E-Mail sales@sick.com.tw

Türkiye

Phone +90 (216) 528 50 00
E-Mail info@sick.com.tr

United Arab Emirates

Phone +971 (0) 4 8865 878
E-Mail info@sick.ae

USA/México

Phone +1(952) 941-6780
1 800-325-7425 - tollfree
E-Mail info@sickusa.com

More representatives and agencies
at www.sick.com