

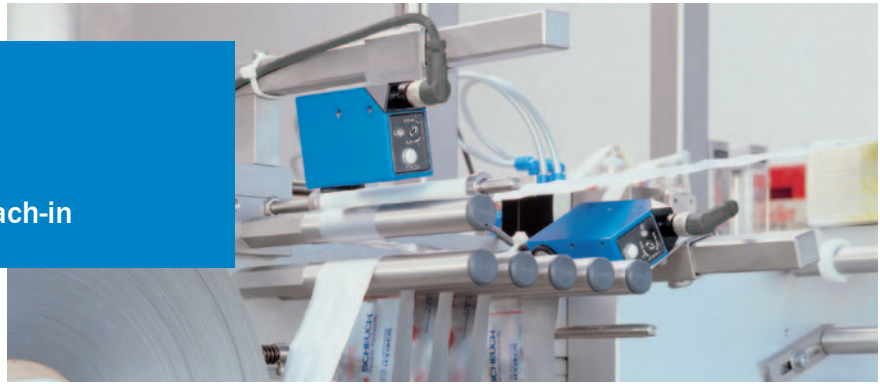

KT5-2 Teach-in Contrast Sensors

Contrast sensors with easy teach-in

Contrast sensors with easy teach-in



Product description

KT5-2 contrast sensors are ideal for high-precision contrast detection, such as for detecting marks on high-gloss materials. Due to the 3-color LED technology, the sensors activate the best possible emitted light source for each contrast. In addition, the sensors feature application-specific teach-in processes. The sensor defines all necessary parameters automatically – either via the teach-in button on the device or via an external control cable. The sensor then determines the

ideal switching threshold from the two gray values detected. High-precision contrast detection; automatic adaptation for high-gloss objects; sensing distances of 10 mm, 20 mm and 40 mm; a switching frequency of 10 kHz; and individual alignment and mounting options make the device suitable for a wide range of tasks. Lastly, the 90° rotatable M12 plug provides simple mounting.

At a glance

- Tough, metal housing
- Various teach-in methods via control panel or control cable
- Maximum detection reliability due to 3-color RGB LED technology
- Switching frequency of 10 kHz
- Various sensing distances and light spot directions
- M12 plug can be rotated 90°

Your benefits

- All print marks and color combinations are reliably detected, ensuring high machine throughput
- Reliable operation, even with jittering webs and high-gloss materials
- High positioning accuracy improves packaging quality
- Various sensing distances, light spot directions and light emissions make individual configuration and simple integration into the production process possible



Additional information

Detailed technical data.....3
 Ordering information.....4
 Dimensional drawing6
 Adjustments6
 Connection type and diagram7
 Sensing distance.....7
 Recommended accessories.....8
 Setting the switching threshold 10

Detailed technical data

Features

Dimensions (L x W x H)	80 mm x 30.4 mm x 53 mm
Light emission	Long and short side of housing, exchangeable

Mechanics/electronics

Supply voltage V_s ¹⁾	DC 10 V ... 30 V
Ripple ²⁾	$\leq 5 V_{PP}$
Power consumption ³⁾	< 80 mA
Switching frequency ⁴⁾	10 kHz
Response time ⁵⁾	50 μ s
Switching output voltage	PNP: HIGH = $V_s - \leq 2 V$ / LOW approx. 0 V NPN: HIGH = approx. $V_s /$ LOW $\leq 2 V$
Output current I_{max}	100 mA
Input, teach-in (ET)	PNP: Teach: $U = 10 V \dots < U_v$ Run: $U < 2 V$ NPN: Teach: $U < 2 V$ Run: $U = 10 V \dots < U_v$
Input, light/dark (L/D)	PNP: Light: $U = 0 V$ Dark: $U > 10 V \dots < U_v$ NPN: Light: $U = U_v$ Dark: $U = 0 V$
Retention time (ET)	25 ms, non-volatile memory
Protection class ⁶⁾	II III (KT5RG)
Circuit protection	V_s connections reverse-polarity protected Output Q short-circuit protected Interference suppression
Enclosure rating	IP 67
Weight	Approx. 400 g
Housing material	Die-cast zinc

¹⁾ Limit values. Operation in short-circuit protected network max. 8 A.

²⁾ May not exceed or fall short of V_s tolerances.

³⁾ Without load.

⁴⁾ With light/dark ratio 1:1.

⁵⁾ Signal transit time with resistive load.

⁶⁾ Reference voltage 50 V DC.

Ambient data

Ambient temperature	Operation: $-10\text{ }^\circ\text{C} \dots +55\text{ }^\circ\text{C}$ Storage: $-25\text{ }^\circ\text{C} \dots +75\text{ }^\circ\text{C}$
Shock load	According to IEC 60068

Specific data

Light source ¹⁾	Connection type	Adjustment	Model name	Ordering information
LED red, green, blue ²⁾	Connector M12, 5-pin	Static 2-point teach-in	KT5W-xxx6	4
		Dynamic teach-in	KT5W-xxx3	4
LED red, green ³⁾	Connector M12, 4-pin	Static 2-point teach-in	KT5RG-xxx6	5

¹⁾ Average service life of 100,000 h at T_A = +25 °C .

²⁾ Wave length: 470 nm, 525 nm, 640 nm.

³⁾ Wave length: 525 nm, 640 nm.

Ordering information

KT5W-xxx6

- **Light source:** LED red, green, blue
- **Connection type:** Connector M12, 5-pin
- **Adjustment:** Static 2-point teach-in

Sensing distance ¹⁾	Sensing distance tolerance	Light spot size	Light spot direction ²⁾	Time delay	Switching output	Model name	Part no.
10 mm	± 3 mm	1.2 mm x 4.2 mm	Vertical	20 ms	PNP	KT5W-2P1126	1018587
				-	PNP	KT5W-2P1116	1018044
			Horizontal	-	NPN	KT5W-2N1116	1018045
				-	PNP	KT5W-2P2116	1022312
20 mm	± 3 mm	1.5 mm x 5.5 mm	Vertical	-	PNP	KT5W-2P1216	1018586
				-	NPN	KT5W-2N1216	1019022
			Horizontal	-	PNP	KT5W-2P2216	1019020
40 mm	± 3 mm	1.1 mm x 4.2 mm	Vertical	-	PNP	KT5W-2P1316	1018961
					NPN	KT5W-2N1316	1022687

¹⁾ From front edge of lens.

²⁾ In relation to long side of housing.

KT5W-xxx3

- **Light source:** LED red, green, blue
- **Connection type:** Connector M12, 5-pin
- **Adjustment:** Dynamic teach-in

Sensing distance ¹⁾	Sensing distance tolerance	Light spot size	Light spot direction ²⁾	Time delay	Switching output	Model name	Part no.
10 mm	± 3 mm	1.2 mm x 4.2 mm	Vertical	20 ms	PNP	KT5W-2P1123	1017810
				-	PNP	KT5W-2P1113	1016629
				-	NPN	KT5W-2N1113	1016630
			Horizontal	-	PNP	KT5W-2P2113	1018043
				-	NPN	KT5W-2N2113	1018042
				-	-	-	-
20 mm	± 3 mm	1.5 mm x 5.5 mm	Vertical	-	PNP	KT5W-2P1213	1016715
					NPN	KT5W-2N1213	1016716
40 mm	± 3 mm	1.1 mm x 4.2 mm	Vertical	20 ms	PNP	KT5W-2P1323	1018808
			Horizontal	20 ms	PNP	KT5W-2P2323	1022165

¹⁾ From front edge of lens.

²⁾ In relation to long side of housing.

KT5RG-xxx6

- **Light source:** LED red, green
- **Connection type:** Connector M12, 4-pin
- **Adjustment:** Static 2-point teach-in

Sensing distance ¹⁾	Sensing distance tolerance	Light spot size	Light spot direction ²⁾	Time delay	Switching output	Model name	Part no.
10 mm	± 3 mm	1.2 mm x 4.2 mm	Vertical	20 ms	PNP	KT5RG-2P1126	1027396
				-	PNP	KT5RG-2P1116	1027393
					NPN	KT5RG-2N1116	1027394

¹⁾ From front edge of lens.

²⁾ In relation to long side of housing.

Dimensional drawing

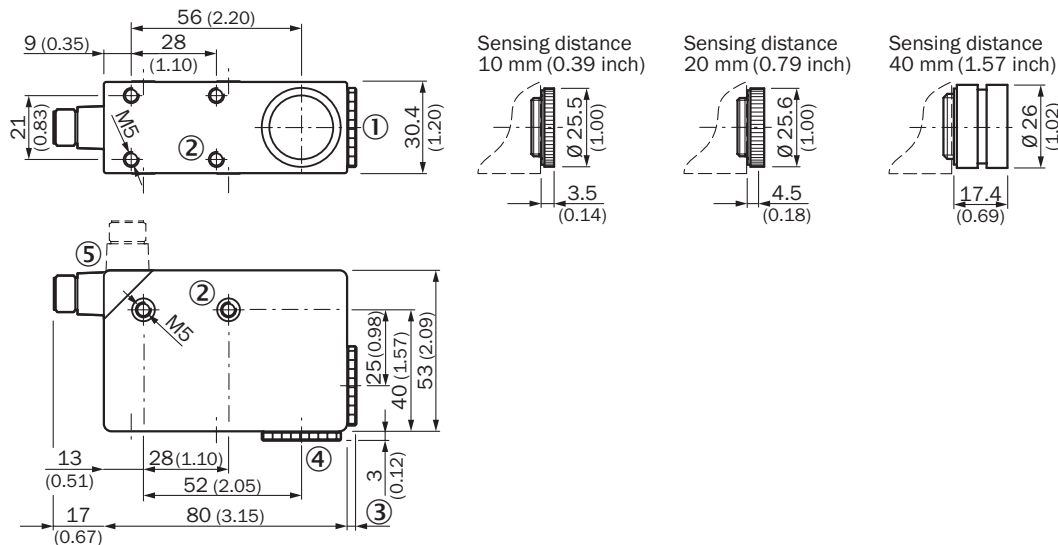

All dimensions in mm (inch)

Adjustments

KT5-2 Teach-in
KT5W-xxx6

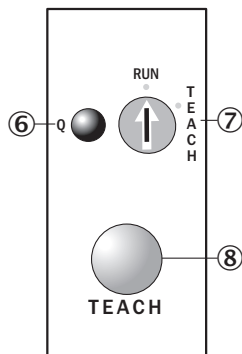

KT5-2 Teach-in
KT5W-xxx3

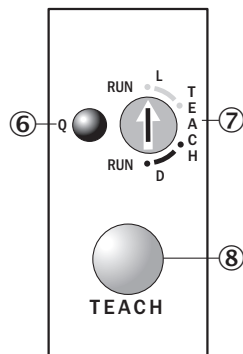

KT5-2 Teach-in
KT5RG-xxx6

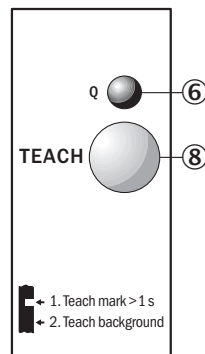

- ① Lens (light transmission), can be exchanged for pos. 4
- ② M5 threaded mounting hole, 5.5 mm deep
- ③ See dimensional drawing for lens
- ④ Blind screw can be replaced by pos. 1
- ⑤ Connector M12 (rotatable up to 90°)
- ⑥ Function signal indicator (yellow)
- ⑦ Pre-selection switch
- ⑧ Teach-in button

Connection type and diagram

KT5W-xxx6
Connector
M12, 5-pin

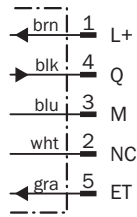
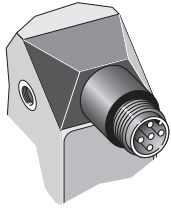

KT5W-xxx3
Connector
M12, 5-pin

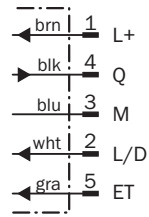
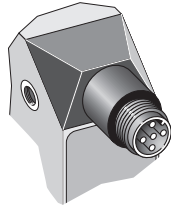

KT5RG-xxx6
Connector
M12, 4-pin

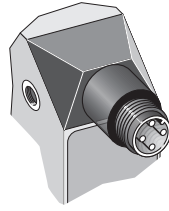

Sensing distance

KT5-2 Teach-in
KT5W

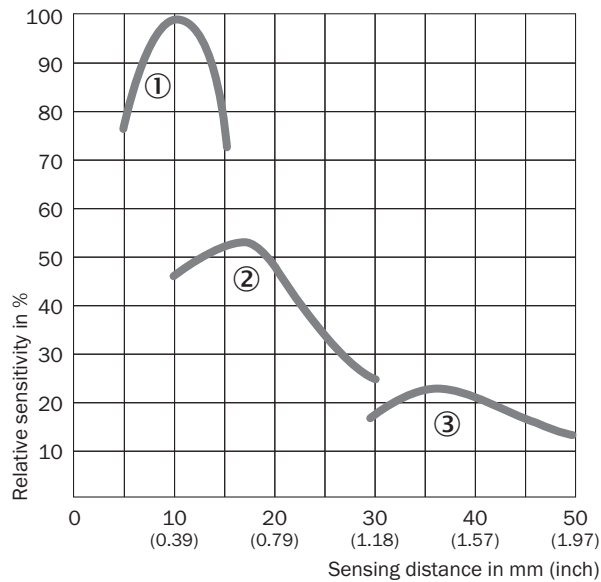

- ① Sensing distance 10 mm
- ② Sensing distance 20 mm
- ③ Sensing distance 40 mm

KT5-2 Teach-in
KT5RG

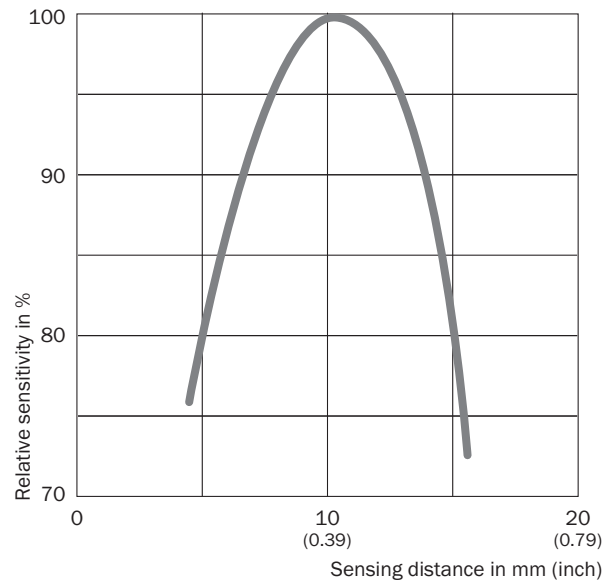

Recommended accessories

Plug connectors and cables

Connector M12, 4-pin

Connector type	Enclosure rating	Flying leads	Sheath material	Cable length	Type	Part no.
Female connector	IP 67	Straight	PVC	2 m	DOL-1204-G02M	6009382
				5 m	DOL-1204-G05M	6009866
				10 m	DOL-1204-G10M	6010543
				15 m	DOL-1204-G15M	6010753
		Angled	PVC	2 m	DOL-1204-W02M	6009383
				5 m	DOL-1204-W05M	6009867
				10 m	DOL-1204-W10M	6010541
					DOS-1204-G	6007302
		Angled		DOS-1204-W	6007303	

Connector M12, 5-pin

Connector type	Enclosure rating	Flying leads	Sheath material	Cable length	Model name	Part no.		
Female connector	IP 67	Straight	PVC	2 m	DOL-1205-G02M	6008899		
				5 m	DOL-1205-G05M	6009868		
				10 m	DOL-1205-G10M	6010544		
		Angled	PVC	2 m	DOL-1205-W02M	6008900		
				5 m	DOL-1205-W05M	6009869		
				10 m	DOL-1205-W10M	6010542		
				Straight	-	-	DOS-1205-G	6009719
				Angled	-	-	DOS-1205-W	6009720

Terminal and alignment brackets

Mounting system type	Description	Material	Model name	Part no.
Universal bar clamps	Plate G for universal bar clamp	Steel, zinc coated	BEF-KHS-G01	2022464
	Plate K for universal bar clamp	Steel, zinc coated	BEF-KHS-K01	2022718
	Universal bar clamp	Die-cast zinc	BEF-KHS-KH1	2022726
	Mounting rod straight	Steel, zinc coated	BEF-MS12G-A	4056054
			BEF-MS12G-B	4056055
	Mounting rod L-shaped	Steel, zinc coated	BEF-MS12L-A	4056052
BEF-MS12L-B			4056053	

BEF-KHS-G01



All dimensions in mm (inch)

BEF-KHS-K01

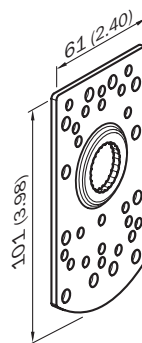

All dimensions in mm (inch)

BEF-KHS-KH1

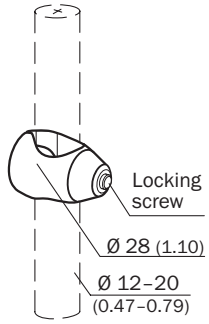

All dimensions in mm (inch)

BEF-MS12G-A (size A = 200 mm)
BEF-MS12G-B (size A = 300 mm)

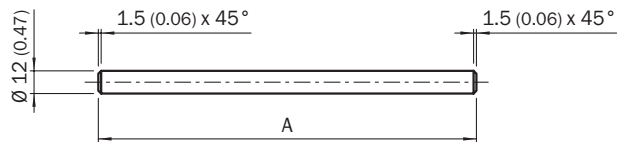

All dimensions in mm (inch)

BEF-MS12L-A (size A/B = 150 mm)
BEF-MS12L-B (size A/B = 250 mm)

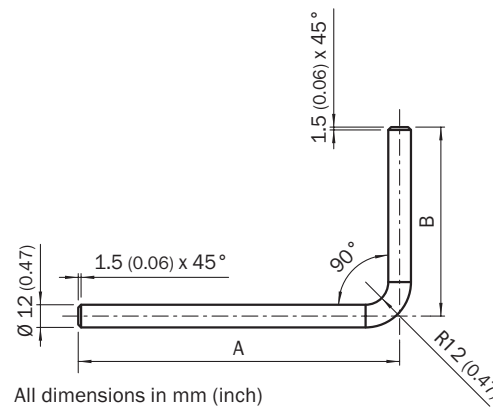

All dimensions in mm (inch)

Principle of function – terminal and alignment brackets

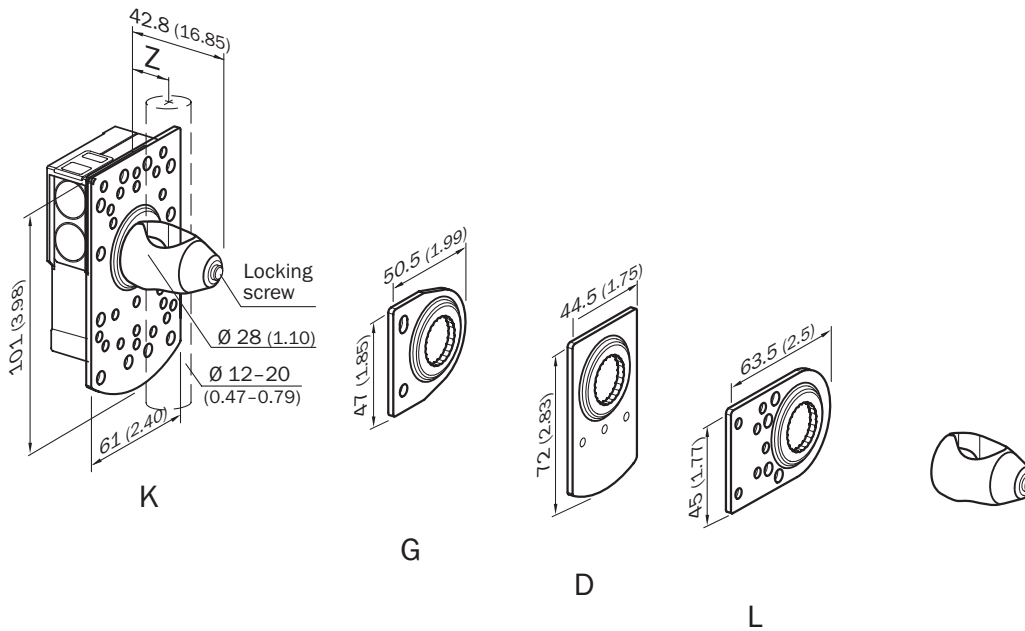

All dimensions in mm (inch)

Lenses (only replacement 1:1)

Sensing distance	Model name	Part no.
10 mm	OBJ-211	1004936
20 mm	OBJ-212	1011506
40 mm	OBJ-210	2010945

OBJ-211

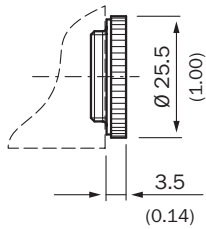

All dimensions in mm (inch)

OBJ-212

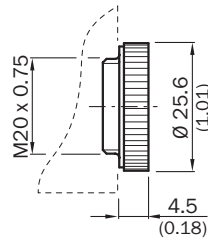

All dimensions in mm (inch)

OBJ-210

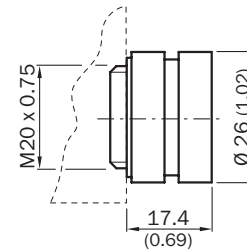

All dimensions in mm (inch)

Setting the switching threshold via teach-in (static 2-point teach-in)

1. Position mark

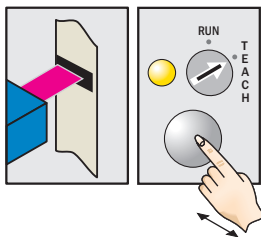

Turn rotary switch to “Teach” position. Press and hold teach-in button > 1 s. Red emitted light and yellow LED flash.

2. Position background

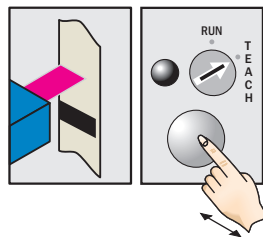

Press and hold teach-in button > 1 s. Yellow LED goes out.

Example

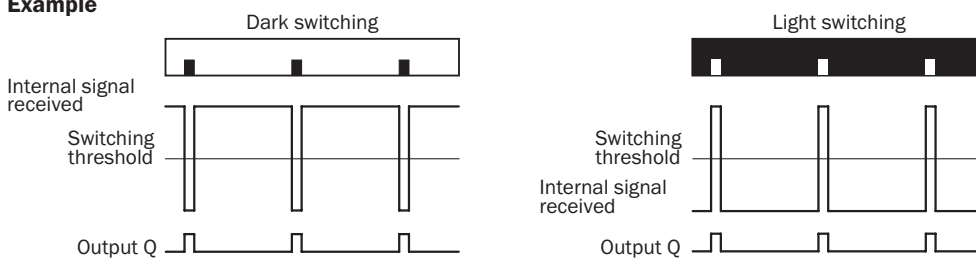

Switching characteristics

The optimum emitted light is selected automatically.
 Light/dark setting is defined using teach-in sequence.
 The switching threshold is set in the center between the background and the mark.
 Teach-in can also be performed using an external control signal.

Setting the switching threshold via teach-in (dynamic)

1. Select switching function (light/dark)

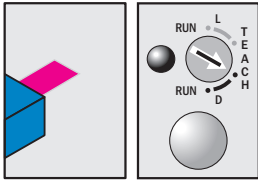

Turn rotary switch to desired teach position:
D = dark switching
L = light switching

2. Position mark or background

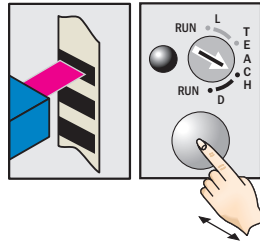

Press the teach-in button and keep it pressed.

3. Move at least one repeat length using the light spot

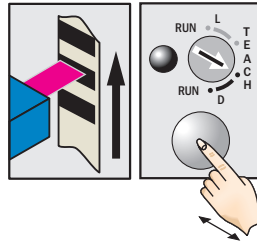

Keep the teach-in button pressed.

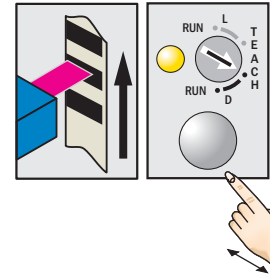

Release the teach-in button. Yellow LED will illuminate, when emitted light is on the mark.

Example

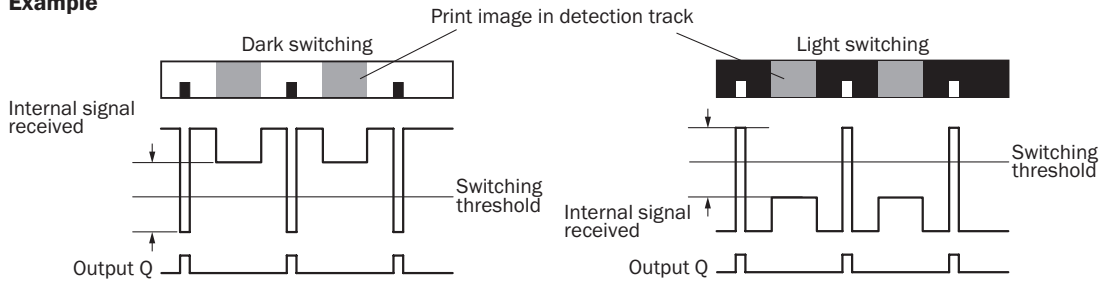

Switching characteristics

The optimum emitted light is selected automatically.
The switching threshold is set in the center between the lowest and the second-lowest reflectivity.
Teach-in can also be performed using an external control signal.
Light/dark setting can also be configured using an external control signal.
Observe the minimum speed (25 mm/s ... 300 mm/s).

Worldwide presence with subsidiaries in the following countries:

Australia
Belgium/Luxembourg
Brasil
Ceská Republika
China
Danmark
Deutschland
España
France
Great Britain
India
Israel
Italia
Japan
Nederland
Norge

Österreich
Polska
Republic of Korea
Republika Slovenija
România
Russia
Schweiz
Singapore
Suomi
Sverige
Taiwan
Türkiye
United Arab Emirates
USA/Canada/México

Please find detailed addresses and additional representatives and agencies in all major industrial nations at www.sick.com

Handed over by:

Our business segment expertise

Factory automation

With its intelligent sensors, safety systems, and automatic identification applications, SICK provides comprehensive solutions for factory automation.



- Non-contact detecting, counting, classifying, and positioning of any type of object
- Accident protection and personal safety using sensors, as well as safety software and services

Logistics automation

Sensors made by SICK form the basis for automating material flows and the optimization of sorting and warehousing processes.



- Automated identification with barcode and RFID reading devices for the purpose of sorting and target control in industrial material flow
- Detecting volume, position, and contours of objects and surroundings with laser measurement systems

Process automation

Optimized system solutions from SICK ensure efficient acquisition of environmental and process data in many industrial processes.



- Precise measurement of gases, liquids and dust concentrations for continuous monitoring of emissions and the acquisition of process data in production processes
- Gas flow measurements with maximum accuracy thanks to compact gas meters