



# LFV310-XXGBVXNTL

LFV300

LEVEL SENSORS

**SICK**  
Sensor Intelligence.



### Ordering information

Type	Part no.
LFV310-XXGBVXNTL	6048143

Other models and accessories → [www.sick.com/LFV300](http://www.sick.com/LFV300)

Illustration may differ



### Detailed technical data

#### Features

<b>Medium</b>	Fluids
<b>Measurement</b>	Switch
<b>Probe length</b>	117 mm
<b>Process pressure</b>	-1 bar ... 64 bar
<b>Process temperature</b>	-50 °C ... +150 °C
<b>Fill material density</b>	0.5 g/cm <sup>3</sup> ... 2.5 g/cm <sup>3</sup>
<b>GOST approval</b>	✓

#### Performance

<b>Accuracy of sensor element</b>	± 2 mm
<b>Repeatability</b>	≤ 1 mm
<b>Viscosity</b>	0.1 mPas ... 10,000 mPas
<b>Response time</b>	500 ms

#### Electronics

<b>Residual ripple</b>	≤ 5 V <sub>pp</sub>
<b>Power consumption</b>	< 10 mA
<b>Initialization time</b>	< 2 s
<b>VDE protection class 2</b>	✓
<b>Electrical connection</b>	½" NPT
<b>Supply voltage</b>	Volt-free transistor output PNP/ NPN: 10 V DC ... 55 V DC
<b>Hysteresis</b>	2 mm
<b>Signal voltage HIGH</b>	U <sub>v</sub> -3 V
<b>Signal voltage LOW</b>	< 1 V
<b>Output current</b>	< 300 mA
<b>Inductive load</b>	1 H
<b>Capacitive load</b>	100 nF

<b>Enclosure rating</b>	IP 66 / IP 67
<b>Temperature drift</b>	0,03 mm/K

Mechanics

<b>Wetted parts</b>	Stainless steel 316L (optional Ra ≤ 0.8 µm)
<b>Process connection</b>	G ¾ A PN 64 / 1.4404
<b>Housing material</b>	Plastic
<b>Sensor material</b>	Stainless steel 1.4404

Ambient data

<b>Ambient operating temperature</b>	-40 °C ... +70 °C
<b>Ambient storage temperature</b>	-40 °C ... +80 °C

Classifications

<b>ECl@ss 5.0</b>	27273202
<b>ECl@ss 5.1.4</b>	27273202
<b>ECl@ss 6.0</b>	27273202
<b>ECl@ss 6.2</b>	27273202
<b>ECl@ss 7.0</b>	27273202
<b>ECl@ss 8.0</b>	27273202
<b>ECl@ss 8.1</b>	27273202
<b>ECl@ss 9.0</b>	27273202
<b>ETIM 5.0</b>	EC002654
<b>ETIM 6.0</b>	EC002654
<b>UNSPSC 16.0901</b>	41111938

### Dimensional drawing (Dimensions in mm (inch))

#### LFV310

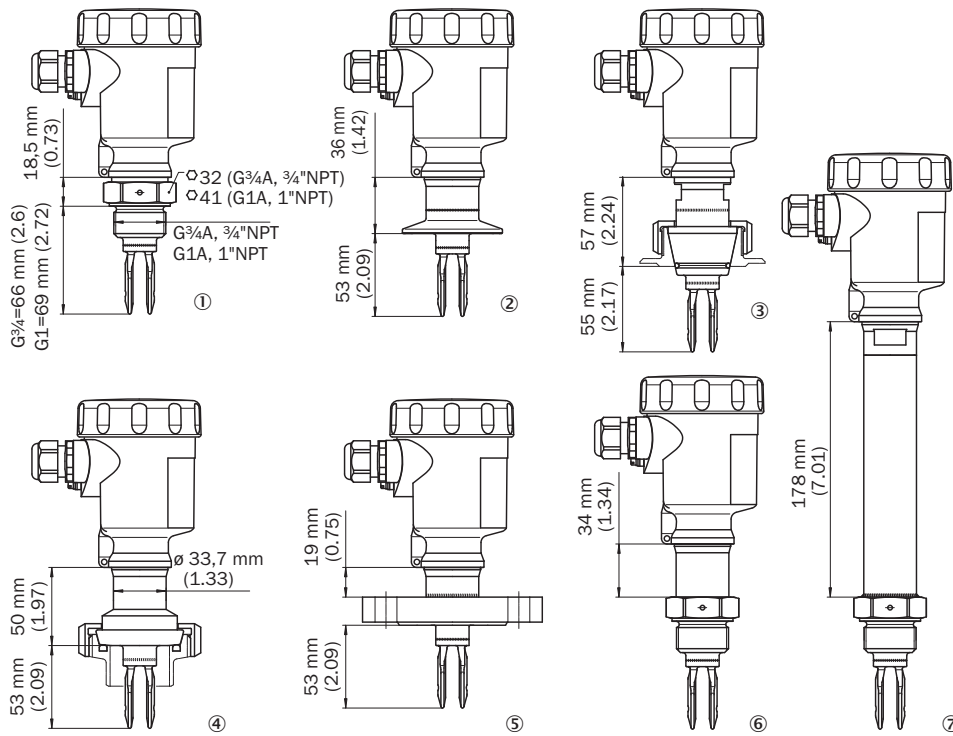

- ① Thread
- ② Tri-Clamp
- ③ DN 25 cone
- ④ Bolting D 40
- ⑤ Flange
- ⑥ Gas-tight leadthrough
- ⑦ Temperature adapter

#### Marking on the welded flange

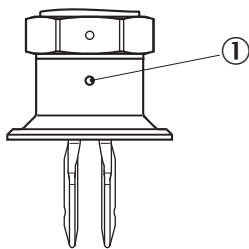

- ① Marking

## Connection diagram

Transistor - electronic module

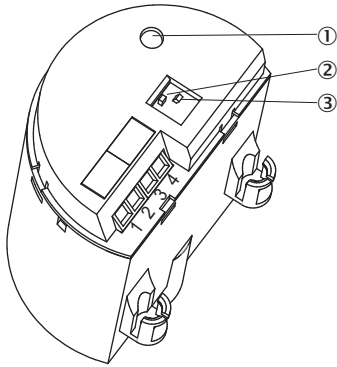

- ① Signal lamp (LED)
- ② DIL switch for mode adjustment
- ③ DIL-switch for sensitivity adjustment

PNP action

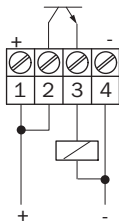

NPN action

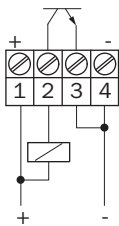

## Instruction for installation

Inflowing medium

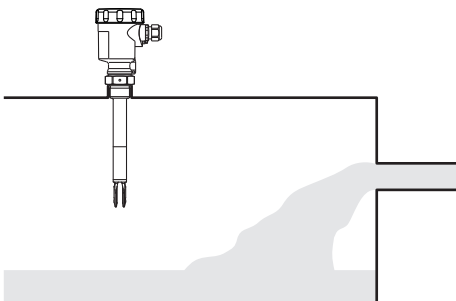

### Characteristic curve



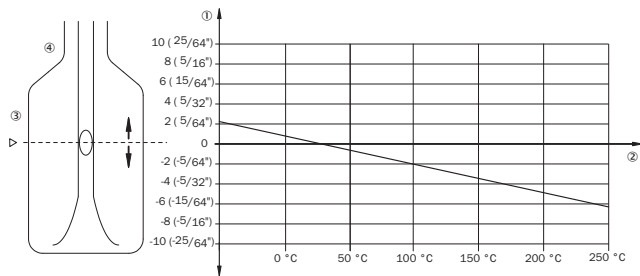



Influence of the process temperature on the switching point



- ① Shifting of the switching point in mm (in)
- ② Process temperature in °C (°F)
- ③ Switching point at reference conditions (notch)
- ④ Tuning fork

### Recommended accessories

Other models and accessories → [www.sick.com/LFV300](http://www.sick.com/LFV300)

	Brief description	Type	Part no.
<b>Flanges</b>			
	Welded flange/welded connector, DIN11851-1, DN25 / PN40, Stainless steel 1.4404	BEF-FL-851D25-LFV2	5321527
	Welded flange/welded connector, process connection G 1, Stainless steel 1.4404	BEF-FL-GEWG10-LFV2	4054605
	Welded flange/welded connector, G 3/4 process connection, Stainless steel 1.4404	BEF-FL-GEWG34-LFV2	4054604
	Welded flange/welded connector, process connection Tri-Clamp 1", Stainless steel 1.4404	BEF-FL-TCLI10-LFV2	5321678
	Welded flange/welded connector, process connection Tri-Clamp 2", Stainless steel 1.4404	BEF-FL-TCLI20-LFV2	5321679
<b>Mounting brackets and mounting plates</b>			
	Lock nut fitting, process pressure -1 bar to 64 bar, G 1 A process connection, G 3/4 A female thread, stainless steel 316L	BEF-MU-316G10-ALFV	5322463
<b>Electronic modules</b>			
	Transistor (PNP/NPN): 10 V DC ... 55 V DC	ECD-RE-LFVP-NP-0001	6038672

## SICK AT A GLANCE

SICK is one of the leading manufacturers of intelligent sensors and sensor solutions for industrial applications. A unique range of products and services creates the perfect basis for controlling processes securely and efficiently, protecting individuals from accidents and preventing damage to the environment.

We have extensive experience in a wide range of industries and understand their processes and requirements. With intelligent sensors, we can deliver exactly what our customers need. In application centers in Europe, Asia and North America, system solutions are tested and optimized in accordance with customer specifications. All this makes us a reliable supplier and development partner.

Comprehensive services complete our offering: SICK LifeTime Services provide support throughout the machine life cycle and ensure safety and productivity.

For us, that is “Sensor Intelligence.”

## WORLDWIDE PRESENCE:

Contacts and other locations –[www.sick.com](http://www.sick.com)