

# Switched Mode Power Supply Specifications

Bulletin Numbers 1606-XL, -XLE, -XLP, -XLS

Topic	Page
Quick Selection Table	2
1606-XLS Power Supplies Specifications and Approximate Dimensions	3
1606-XLE Power Supplies	5
1606-XLP Power Supplies	7
1606-XL Power Supplies	9
Specialty Modules	12
Accessory Approximate Dimensions	14
Application Information	16

## Additional Resources

These documents contain additional information concerning related products from Rockwell Automation.

Resource	Description
Industrial Automation Wiring and Grounding Guidelines, publication <a href="#">1770-4.1</a>	Provides general guidelines for installing a Rockwell Automation industrial system.
Product Certifications website, <a href="http://www.ab.com">http://www.ab.com</a>	Provides declarations of conformity, certificates, and other certification details.

You can view or download publications at <http://www.rockwellautomation.com/literature/>. To order paper copies of technical documentation, contact your local Allen-Bradley distributor or Rockwell Automation sales representative.



Quick Guide

Bulletin 1606 ▲ Power Supply Quick Guide

	15...40 W	50 W	60 W	72...80 W	90...100 W	120 W	180 W	240 W	480 W	720 W	960 W
5...5.5V	XLP15A XLP25A	—	—	—	—	—	—	—	—	—	—
10...12V	XLP30B	—	—	—	—	—	—	—	—	—	—
12...15V 1-Ph	XLP15B	XLP50B	XLP60BQ XLP60BQT	—	XLP90B	—	XL180B	—	—	—	—
12...15 V 3-Ph	—	—	—	—	XLE96B	—	—	—	—	—	—
(+/-)12 and 15V	XLP36C	—	—	—	—	—	—	—	—	—	—
24...28V 1-Ph	XLP15E XLP30E XLP30EQ	XLP50E XLP50EZ	XL60D XLP60EQ XLP60EQT	XLS80E XLE80E XLP72E	XLP95E XLP100E	XLS120E XLS120EA XLE120E XLE120EC XLE120EE XLE120EN	—	XLS240E XLS240EC XLE240E XLE240EP XLE240EE XLE240EN	XLS480E XLS480EA XLS480EC XLS480EE	—	XLS960EE
24...28V 2-Ph/3-Ph	—	—	—	—	XLP90E-2 XLP100E-2	XLE120E-2	—	XL240E-3C XLE240E-3	XLS480E-3 XLS480E-3C	XL720E-3	XLE960DX-3N XLS960E-3
36...43V	—	—	—	—	—	—	—	—	XLS480G-3	—	—
48...56V 1-Ph	—	XLP50F	—	—	XLP100F	—	—	XLE240F	XLS480F	—	XLS960FE
48...56V 3-Ph	—	—	—	—	—	—	—	XLE240F-3	XLS480F-3	—	XLE960MX-3N XLS960F-3
24V Redundant	—	—	XL60DR	—	—	XL120DR	—	XL240DR	—	—	—
DeviceNet	—	—	—	XLEDNET3	XLSDNET4	—	—	XLSDNET8	—	—	—

▲ Example: For a 24...28 Volt, 3-Phase, 120 Watt power supply, the **Cat. No.** would be **1606-XL120E-3**.

Special Applications

Bulletin Number	NEC Class 2	ABS/GL Marine	Hazardeous Location Rating, Class 1 Div 2	ODVA Requirements	Conformal Coating	ATEX
1606-XLE	XLE80E	All XLE Power Supplies	All XLE Power Supplies	XLEDNET3	XLE120EC	—
1606-XLP	XLP15A XLP15B XLP15E XLP25A XLP30B XLP30E XLP36C XLP50B XLP50E XLP50EZ XLP50F XLP72E XLP90B XLP90E-2 XLP95E	XLP15A XLP15B XLP15E XLP25A XLP30E XLP36C XLP50E XLP50EZ XLP72E XLP90B XLP100E XLP100F XLPRED	XLP15A XLP15B XLP15E XLP25A XLP30B XLP30E XLP50B XLP50E XLP50EZ XLP72E XLP90B XLP90E XLP100E XLPRED	—	—	—
1606-XLS	XLSDNET4	ALL XLS Power Supplies	All XLS Power Supplies★	XLSDNET4 XLSDNET8	XLS240EC XLS480E-C XLS480E-3C	XLS120EA XLS240EA XLS480EA

★ Cat. No. 1606-XLS240K does not have Hazardeous Location Rating.

Bulletin 1606-XLS

	1606-XLS80E	1606-XLS120E 1606-XLS120EA&	1606-XLS180B	1606-XLS240E 1606-XLS240EA& 1606-XLS240EC▲
<b>Output Volts/Watts</b>	24...28V/80 W	24...28V/120 W	12...15V/180 W	24...28V/240 W
<b>Input Voltage (47...63 Hz)</b>	100...240V AC, 110...150V DC	100...240V AC, 110...300V DC	100...240V AC, 110...150V DC	100...240V AC, 110...150V DC
<b>Operational Range</b>	85...276V AC, 88...188V DC	85...264V AC, 88...360V DC	85...264V AC, 88...188V DC	85...276V AC, 88...188V DC
<b>Hold-up Time</b>	27...174 ms	33...59 ms	32 ms	27 ms
<b>Rated Input Current</b>	1.4 A (100V AC), 0.82 A (240V AC)	1.4 A (100V AC), 0.65 A (240V AC)	1.65 A (120V AC), 0.93 A (230V AC)	2.8 A (100V AC), 1.2 A (240V AC)
<b>Efficiency</b>	typ. 90.0%	typ. 92.7%	typ. 91.5%	typ. 91.8%
<b>Output Voltage</b>	24...28V	24...28V	12...15V	24...28V
<b>Rated Output Current</b>	3.4 A (@ 24V) 3.0 A (@ 28V)	5 A (@ 24V) 4.5 A (@ 28V)	15 A	10 A (@ 24V) 9 A (@ 28V)
<b>ReservePower (typ. 4 s)</b>	5.4 A (@ 24V) 5.0 A (@ 28V)	7.5 A (@ 24V) 6.7 A (@ 28V)	22.5 (@12V)	15 A (@ 24V) 13.5 A (@ 28V)
<b>Ripple/Noise</b>	<100 mV <sub>PP</sub>	<50 mV <sub>PP</sub>	<50 mV <sub>PP</sub>	<50 mV <sub>PP</sub>
<b>Operating Temperature Range (T<sub>amb</sub>)</b>	-25...+70 °C >60 °C with derating			
<b>Non-Operating Temperature Range</b>	-40...+85 °C			
<b>MTBFΔ</b>	>650 000 hours	>831 000 hours	>577 000 hours	>581 000 hours
<b>Dimensions (W x H x D)</b>	32 x 124 x 102 mm	40 x 124 x 117 mm	60 x 124 x 117 mm	60 x 124 x 117 mm
<b>Weight</b>	420 g	620 g	900 g	900 g
<b>Certifications/Standards ★</b>	1, 2, 3, 5, 6, 7, 9			1, 2, 3, 5, 6, 7, 8, 9
<b>Special Features</b>	Active PFC; Class 1 Div. 2; Semi F47, 9) ABS/GL/RINA (Marine)			

★ 1) = CE, 2) = UL 508 (cULus LISTED), 3) = UL 1950 (cURus), 4) = CSA C22.2, No. 60950, 5) Safety standards = IEC/EN 60950, EN 50178, 6) EMC standards = EN 55011 (Class B), EN 55022 (Class B), EN 61000-6-2, 7) EMC standards = EN 61000-3-2 (A14), EN 50081-1, 8) ATEX, 9) GL/ABS

Δ MTBF determined by Siemens norm SN 29500 at full load current and 40 °C, 8) ATEX

& Indicates ATEX rating

▲ Indicates conformal coating

	1606-XLS480E 1606-XLS480EA& 1606-XLS480EC▲	1606-XLS480E-3 1606-XLS480E-3C▲	1606-XLS480F	1606-XLS480F-3	1606-XLS480G	1606-XLS480G-3
<b>Output Volts/Watts</b>	24...28V/480 W	24...28V/480 W	48...56V/480 W	48...56V/480 W	36...42V/480 W	36...42V/480 W
<b>Input Voltage (47...63 Hz)</b>	100...240V AC /110...150V DC	380...480V AC, 600V DC	100...240V AC, 110...300V DC	380...480V AC, 600V DC	100...240V AC, 110...300V DC	380...480V AC, 600V DC
<b>Operational Range</b>	85...276V AC, 88...188V DC	323...552V AC, 450...780V DC	85...276V AC, 88...375V DC	323...552V AC, 450...780V DC	85...276V AC, 88...375V DC	323...552V AC, 450...780V DC
<b>Hold-up Time</b>	32...51 ms	19 ms	32...51 ms	22 ms	32...51 ms	22 ms
<b>Rated Input Current</b>	4.6 A (100V AC), 2.5 A (240V AC)	0.9 A (380V AC), 0.65 A (480V AC)	4.6 A (100V AC), 2.5 A (240V AC)	0.79 A (380V AC), 0.65 A (480V AC)	4.6 A (100V AC), 2.5 A (240V AC)	0.79 A (380V AC), 0.65 A (480V AC)
<b>Efficiency</b>	typ. 92.4%	typ. 94.8%	typ. 92.4%	typ. 95.4 %	typ. 92.4%	typ. 94.8%
<b>Output Voltage</b>	24...28V	24...28V	24...28V	48...55V	36...42V	36...42V
<b>Rated Output Current</b>	20 A (@ 24V) 17 A (@ 28V)	20 A (@ 24V) 17.5 A (@ 28V)	20 A (@ 24V) 17 A (@ 28V)	10 A (@ 48V)	13 A (@ 36V)	13.3 A (@ 36V)
<b>ReservePower (typ. 4 s)</b>	30 A (@ 24V) 26 A (@ 28V)	30 A (@ 24V) 26 A (@ 28V)	30 A (@ 24V)	15 A (@ 48V)	20 A (@ 42V)	20 A (@ 42V)
<b>Ripple/Noise</b>	<100 mV <sub>PP</sub>	<100 mV <sub>PP</sub>	<100 mV <sub>PP</sub>	<100 mV <sub>PP</sub>	<100 mV <sub>PP</sub>	<100 mV <sub>PP</sub>
<b>Operating Temperature Range (T<sub>amb</sub>)</b>	-25...+70 °C >60 °C with derating					
<b>Non-Operating Temperature Range</b>	-25...+70 °C >60 °C with derating					
<b>MTBFΔ</b>	>469 000 hours	>690 000 hours	>469 000 hours	>690 000 hours	> 407 000 hours	> 690 000 hours
<b>Dimensions (W x H x D)</b>	84 x 124 x 127 mm	65 x 124 x 127 mm	84 x 124 x 127 mm	65 x 124 x 127 mm	82 x 124 x127 mm	65 x 124 x127 mm
<b>Weight</b>	1200 g	870 g	1200 g	870 g	1200 g	870 g
<b>Certifications/Standards ★</b>	1, 2, 3, 5, 6, 7, 8, 9		1, 2, 3, 5, 6, 7, 9			
<b>Special Features</b>	ABS/GL/RINA (Marine)					

★ 1) = CE, 2) = UL 508 (cULus LISTED), 3) = UL 1950 (cURus), 4) = CSA C22.2, No. 60950, 5) Safety standards = IEC/EN 60950, EN 50178, 6) EMC standards = EN 55011 (Class B), EN 55022 (Class B), EN 61000-6-2, 7) EMC standards = EN 61000-3-2 (A14), EN 50081-1, 8) ATEX, 9) ABS/GL/RINA (Marine)

Δ MTBF determined by Siemens norm SN 29500 at full load current and 40 °C

& Indicates ATEX rating

▲ Indicates conformal coating

## Bulletin 1606-XLS

	1606-XLS960EE	1606-XLS960E-3	1606-XLS960F-3
Output Volts/Watts	24...28V/960 W	24...28V/960 W	24...28V/960 W
Input Voltage (47...63 Hz)	200...240V AC	380...480 V AC	200...240V AC
Operational Range	170...264V AC	380...480V AC	170...264V AC
Hold-up Time	32 ms	20 ms	20 ms
Rated Input Current	4.6 A	1.65 A	1.65 A
Efficiency	typ. 94.6%	typ. 95.2%	typ. 95.4%
Output Voltage	24...28V	24...28V	48...54V
Rated Output Current	40 A (@ 24V) 34 A (@ 28V)	40 A (@ 24V) 34.3 A (@ 28V)	20 A (@ 48V) 17.8 A (@ 54V)
ReservePower (typ. 4 s)	60 A (@ 24V) 51 A (@ 28V)	60 A (@ 24V) 51 A (@ 28V)	30 A (@ 48V) 26.7 A (@ 54V)
Ripple/Noise	<100 mV <sub>PP</sub>	<100 mV <sub>PP</sub>	<100 mV <sub>PP</sub>
Operating Temperature Range (T <sub>amb</sub> )	-25 °C...+70 °C		
Non-Operating Temperature Range	-40 °C...+85 °C		
Dimensions (W x H x D)	125 x 124 x 127 mm	110 x 124 x 127 mm	125 x 124 x 127 mm
Weight	1800 g	1500 g	1800 g
Certifications/Standards ★	1, 2, 3, 4, 5, 6, 7, 9		
Special Features	Class 1, Div. 2, ABS/GL/RINA (Marine)		

★ 1) = CE, 2) = UL 508 (cULus LISTED), 3) = UL 1950 (cURus), 4) = CSA C22.2, No. 60950, 5) Safety standards = IEC/EN 60950, EN 50178, 6) EMC standards = EN 55011 (Class B), EN 55022 (Class B), EN 61000-6-2, 7) EMC standards = EN 61000-3-2 (A14), EN 50081-1, 9) ABS/GL/RINA (Marine)

△ MTBF determined by Siemens norm SN 29500 at full load current and 40 °C

Bulletin 1606-XLE

	1606-XLE80E	1606-XLE120E 1606-XLE120EC▲	1606-XLE120EE	1606-XLE120EN	1606-XLE240E	1606-XLE240EE	1606-XLE240EN	1606-XLE240EP	1606-XLE240F
<b>Output Volts/Watts</b>	24V...28V/ 80 W	24V...28V/ 120 W	24V...28V/ 120 W	24V...28V/ 120 W	24V...28V/ 240 W	24V...28V/ 240 W	24V...28V/ 240 W	24V...28V/ 240 W	48V...52V/ 240 W
<b>Input Voltage (47...63 Hz)</b>	100...120/ 200...240V AC, 110...150V DC	100...120/ 200...240V AC	200...240V AC	100...120V AC	100...120/ 200...240V AC	200...240V AC	100...120V AC	100...120/200...240V AC	
<b>Operational Range</b>	90...132/ 180...264V AC, 88...188V DC	90...132V AC	180...264V AC	90...132V AC	90...132/ 180...264V AC	180...264V AC	90...132V AC	90...132/180...264V AC	
<b>Hold-up Time</b>	>60 ms (120V) >244 ms (240V)	>80 ms (120V) >78 ms (240V)	>80 ms (120V)	>78 ms (240V)	>46 ms (120V) >42 ms (240V)	>45 ms (240V)	>46 ms (120V)	>46ms (120V) >42ms (240V)	>46ms (120V) >42ms (240V)
<b>Rated Input Current</b>	1.24 A (100V AC) 0.68 A (240V AC)	2.6 A (100V AC) 1.3 A (240V AC)	2.6 A	1.4 A	5 A (100V AC) 2.5 A (240V AC)	2.7 A	5 A	<5.0 A (115V)/<2.3 A (230V)	<1.3 A (115V)/<0.7 A (230V)
<b>Efficiency</b>	typ. 90%	typ. 90%	typ. 90%	typ. 90.2%	typ. 91%	typ. 91.6 %	typ. 90.8 %	typ. 91%	typ. 92%
<b>Output Voltage</b>	24...28V								48...52V
<b>Rated Output Current</b>	3.3 A @ 24V 2.9 A @ 28V	5 A @ 24V 4.3 A @ 28V	5 A @ 24V	5 A @ 24V	10 A @ 24V 8.6 A @ 28V	10 A @ 24V	10 A @ 24V	10 A	5 A @ 48V 4.6 A @ 52V
<b>Ripple/Noise</b>	<50 mV <sub>PP</sub>								
<b>Operating Temperature Range (T<sub>amb</sub>)</b>	-25...+70 °C, >60 °C with derating								
<b>Non-Operating Temperature Range</b>	-40...+85 °C								
<b>MTBF▲</b>	>700 000 hours								
<b>Dimensions (W x H x D)</b>	32 x 124 x 102 mm	32 x 124 x 117 mm			60 x 124 x 117 mm				
<b>Weight</b>	430 g	500 g	500 g	500 g	700 g	700 g	700 g	800 g	700 g
<b>Certifications/Standards ★</b>	1, 2, 3, 4, 5, 6, 7, 9								
<b>Special Features</b>	NEC Class 2	—							

★ 1) = CE, 2) = UL 508 (cULus LISTED), 3) = UL 1950 (cURus), 4) = CSA C22.2, No. 60950, 5) Safety standards = IEC/EN 60950, EN 50178, 6) EMC standards = EN 55011 (Class B), EN 55022 (Class B), EN 61000-6-2, 7) EMC standards = EN 61000-3-2 (A14), EN 50081-1, 9) ABS/GL/RINA (Marine)

▲ MTBF determined by Siemens norm SN 29500 at full load current and 40 °C.

▲ Indicates conformal coating.

Bulletin 1606-XLE

	1606-XLE96B-2	1606-XLE120E-2	1606-XLE240E-3	1606-XLE240F-3	1606-XLE960DX-3N	1606-XLE960MX-3N
<b>Output Volts/ Watts</b>	12V...15V/ 96 W	24V...28V/ 120 W	24V...28V/ 240 W	48V...52V/ 240 W	24V...28V/ 960 W	48V...52V/ 960 W
<b>Input Voltage (47...63 Hz) [V AC]</b>	380...480	380...480	380...480	380...480	480	480
<b>Operational Range [V AC]</b>	380...480	380...480	380...480	380...480	408...552	408...552
<b>Hold-up Time</b>	33 ms (400) 58 ms (480)	27 ms (400) 48 ms (480)	34 ms (400) 54 ms (480)	34 ms (400) 54 ms (480)	3 ms (19V)	3 ms (41V)
<b>Rated Input Current</b>						
<b>Efficiency</b>	87	90	92	92	95	96
<b>Output Voltage</b>	12...15	24...28	24...28	48...56	24	48
<b>Rated Output Current</b>	8 (12) 6.4 (15)	5 (24) 4.3 (28)	10 (24) 8.6 (28)	5 (48) 4.3 (56)	40	20
<b>Ripple/Noise</b>	<50 mV <sub>pp</sub>					
<b>Operating Temperature Range (T<sub>amb</sub>)</b>	-25...+70 °C, >60 °C with derating					
<b>Non-Operating Temperature Range</b>	-40...+85 °C					
<b>MTBF<sup>Δ</sup></b>	>700 000 hours					
<b>Dimensions (W x H x D)</b>	40 x 124 x 117 mm				96 x 124 x 157 mm	
<b>Weight</b>	500 g		750 g		1400 g	
<b>Certifications/Standards ★</b>	1, 2, 3, 4, 5, 6, 7, 9					
<b>Special Features</b>	NEC Class 2		—			

★ 1) = CE, 2) = UL 508 (cULus LISTED), 3) = UL 1950 (cURus), 4) = CSA C22.2, No. 60950, 5) Safety standards = IEC/EN 60950, EN 50178, 6) EMC standards = EN 55011 (Class B), EN 55022 (Class B), EN 61000-6-2, 7) EMC standards = EN 61000-3-2 (A14), EN 50081-1, 9) ABS/GL/RINA (Marine)

Δ MTBF determined by Siemens norm SN 29500 at full load current and 40 °C.

♣ Indicates conformal coating.

Bulletin 1606-XLP

	1606-XLP15A	1606-XLP15B	1606-XLP15E	1606-XLP25A
<b>Output Volts/Watts</b>	5...5.5V/15 W	12...15V/15 W	24...28V/15 W	5...5.5V/25 W
<b>Input Voltage (47...63 Hz)</b>	100...240V AC wide range; 85...370V DC			
<b>Operational Range</b>	85...264V AC			
<b>Hold-up Time</b>	>168 ms (230V AC) >45 ms (100V AC)	>191 ms (230V AC) >46 ms (100V AC)	>196 ms (230V AC) >47 ms (100V AC)	>170 ms (230V AC) >19 ms (100V AC)
<b>Rated Input Current</b>	<0.28 A (100V AC) <0.17 A (196V AC)			<0.5 A (100V AC) <0.35 A (196V AC)
<b>Efficiency</b>	typ. >77%	typ. >83%	typ. >88%	typ. >80%
<b>Output Voltage</b>	5...5.5V 5.1V preset	12...15V	24...28V	5...5.5V 5.1V preset
<b>Rated Output Current</b>	3 A	1.0...1.3 A	0.54...0.63 A	5 A (at 5.1V), 4.5 A (at 5.5V)
<b>Ripple/Noise</b>	<50 mV <sub>pp</sub>	<75 mV <sub>pp</sub>	<50 mV <sub>pp</sub>	<50 mV <sub>pp</sub>
<b>Operating Temperature Range (T<sub>amb</sub>)</b>	-10...+70 °C, >60 °C: 0.4 W/K derating			-10...+70 °C >60 °C: 0.5 W/K derating
<b>Non-Operating Temperature Range</b>	-40...+85 °C			
<b>MTBF<sup>Δ</sup></b>	2 686 000 hours	3 811 000 hours	4 369 000 hours	600 000 hours
<b>Dimensions (W x H x D)</b>	22.5 x 75 x 91 mm			45 x 75 x 91 mm
<b>Weight</b>	130 g			240 g
<b>Certifications/Standards</b> ★	1, 2, 4, 5, 7, 9			
<b>Special Features</b>	NEC Class 2 power supply; ABS/GL/RINA (Marine); Class 1 Div. 2			

★ 1) = CE, 2) = UL 508 (cULus LISTED), 3) = UL 1950 (cURus), 4) = CSA C22.2, No. 60950, 5) Safety standards = IEC/EN 60950, EN 50178, 6) EMC standards = EN 55011 (Class B), EN 55022 (Class B), EN 61000-6-2, 7) EMC standards = EN 61000-3-2 (A14), EN 50081-1, 9) ABS/GL/RINA (Marine)  
 Δ MTBF determined by Siemens norm SN 29500 at full load current and 40 °C

	1606-XLP30B	1606-XLP30E	1606-XLP30EQ	1606-XLP36C	1606-XLP50B
<b>Output Volts/Watts</b>	10...12V/30 W	24...28V/30 W	24...28V/30 W	±12V/±15V/36 W	12...15V/50 W
<b>Input Voltage (47...63 Hz)</b>	100...240V AC wide range; 85...375V DC				
<b>Operational Range</b>	85...264V AC				
<b>Hold-up Time</b>	>170 ms (230V AC) >18 ms (100V AC)	>190 ms (230V AC) >19 ms (100V AC)	>141 ms (230V AC) >31 ms (100V AC)	>180 ms (230V AC) >18 ms (100V AC)	>170 ms (230V AC) >17 ms (100V AC)
<b>Rated Input Current</b>	<0.6 A (100V AC) <0.25 A (240V AC)	<0.6 A (100V AC) <0.35 A (196V AC)	<0.54 A (100V AC) <0.3 A (230V AC)	<0.65 A (AC 100V AC) <0.4 A (AC 196V AC)	<1.0 A (100V AC) <0.6 A (196V AC)
<b>Efficiency</b>	typ. 84%	typ. 87.5%	typ. 88.5%	typ. 86%	typ. 90%
<b>Output Voltage</b>	10...12V 12V preset (with jumper), 10...12V adjustable (without jumper)	24...28V 24.5V preset	24...28V	±12V (without jumper), ±15V (with jumper) ±15V preset	12...15V 15V preset (with jumper) 12...15V adjustable (without jumper)
<b>Rated Output Current</b>	3 A (@ 10V), 2.5 A (@ 12V)	1.3 A (@ 24.5V), 1 A (@ 28V)	1.3 A (@ 24V), 1 A (@ 28V)	0...2.8 A (@ +12V), 0...1.4 A (@ -12V), 0...2.4 A (@ +15V), 0...1.4 A @ (-15V)	4.2 A (@ 12V), 3.4 A (@ 15V)
<b>Ripple/Noise</b>	<10 mV <sub>pp</sub>	<50 mV <sub>pp</sub>	<50 mV <sub>pp</sub>	<50 mV <sub>pp</sub>	<100mV <sub>pp</sub>
<b>Operating Temperature Range (T<sub>amb</sub>)</b>	-10...+70 °C >60 °C: 0.6 W/K derating	-10...+70 °C >60 °C: 0.5 W/K derating	-10...+70 °C >60 °C: 0.8 W/K derating	-10...+70 °C > 60 °C: 1 W/K derating	-10...+70 °C >60 °C: 1 W/K derating
<b>Non-Operating Temperature Range</b>	-10...+70 °C >60 °C: 0.6 W/K derating	-10...+70 °C >60 °C: 0.5 W/K derating	-10...+70 °C >60 °C: 0.5 W/K derating	-10...+70 °C > 60 °C: 1 W/K derating	-10...+70 °C >60 °C: 1 W/K derating
<b>MTBF<sup>Δ</sup></b>	appr. 650 000 hours		2 123 000 hours	600 000 hours	appr. 600 000 hours
<b>Dimensions (W x H x D)</b>	45 x 75 x 91 mm	45 x 75 x 91 mm	22.5 x 75 x 91 mm	45 x 75 x 91 mm	45 x 75 x 91 mm
<b>Weight</b>	250 g	230 g	140 g	240 g	260 g
<b>Certifications/Standards</b> ★	1, 2, 4, 5, 7, 9				
<b>Special Features</b>	NEC Class 2 power supply; Class 1 Div. 2, ABS/GL/RINA (Marine)	NEC Class 2 power supply; Class 1 Div. 2; Semi F47, ABS/GL/RINA (Marine)	NEC Class 2 power supply; Class 1 Div. 2; Semi F47, ABS/GL/RINA (Marine)	Output voltage adjustable: DC ±12V without jumper or DC ±15V with jumper; NEC Class 2 power supply; Class 1 Div. 2; ABS/GL/RINA (Marine)	Output voltage adjustable: DC 12...15V without jumper or DC 15V with jumper; NEC Class 2 power supply; Class 1 Div. 2 ABS/GL/RINA (Marine)

★ 1) = CE, 2) = UL 508 (cULus LISTED), 3) = UL 1950 (cURus), 4) = CSA C22.2, No. 60950, 5) Safety standards = IEC/EN 60950, EN 50178, 6) EMC standards = EN 55011 (Class B), EN 55022 (Class B), EN 61000-6-2, 7) EMC standards = EN 61000-3-2 (A14), EN 50081-1, 9) ABS/GL/RINA (Marine)  
 Δ MTBF determined by Siemens norm SN 29500 at full load current and 40 °C

Bulletin 1606-XLP

	1606-XLP50E	1606-XLP50EZ	1606-XLP50F	1606-XLP60EQ	1606-XLP60EQT
<b>Output Volts/Watts</b>	24...28V/50 W		48...56V/50 W	24...28V/60 W	
<b>Input Voltage (47...63 Hz)</b>	100...240V AC wide range; 85...375V DC				
<b>Operational Range</b>	85...264V AC				
<b>Hold-up Time</b>	>171 ms (230V AC) >17 ms (100V AC)		>170 ms (230V AC) >17 ms (100V AC)	>107 ms (230V AC) >24 ms (120V AC)	
<b>Rated Input Current</b>	<1.0 A (100V AC) <0.6 A (196V AC)				
<b>Efficiency</b>	typ. 88.5%		typ. 90%	typ. 88%	
<b>Output Voltage</b>	24...28V 24.5V preset		48...56V 48V preset	24...28V	
<b>Rated Output Current</b>	2.1 A (@ 24.5V), 1.8 A (@ 28V)		1.05 A (@ 48V), 0.9 A (@ 56V)	2.5 A (@ 24V), 2.1 A (@ 28V)	
<b>Ripple/Noise</b>	<50 mV <sub>pp</sub>		<200 mV <sub>pp</sub>	<50 mV <sub>pp</sub>	
<b>Operating Temperature Range (T<sub>amb</sub>)</b>	-10...+70 °C >60 °C: 1 W/K derating				-40...+70 °C >60 °C: 1 W/K derating
<b>Non-Operating Temperature Range</b>	-40...+85 °C				
<b>MTBF<sup>Δ</sup></b>	appr. 600 000 hours			> 1 292 000 h	
<b>Dimensions (W x H x D)</b>	45 x 75 x 91 mm				
<b>Weight</b>	240 g			250 g	
<b>Certifications/Standards</b> ★	1, 2, 3, 4, 5, 6, 9			1, 2, 3, 4, 5, 6	
<b>Special Features</b>	NEC Class 2 power supply; ABS/GL/RINA (Marine); Class 1 Div. 2; Semi F47	Removeable Terminations; NEC Class 2 power supply; ABS/GL/RINA (Marine); Class 1 Div. 2	NEC Class 2 power supply; ABS/GL/RINA (Marine)	NEC Class 2 power supply	

★ 1) = CE, 2) = UL 508 (cULus LISTED), 3) = UL 1950 (cURus), 4) = CSA C22.2, No. 60950, 5) Safety standards = IEC/EN 60950, EN 50178, 6) EMC standards = EN 55011 (Class B), EN 55022 (Class B), EN 61000-6-2, 7) EMC standards = EN 61000-3-2 (A14), EN 50081-1, 9)ABS/GL/RINA (Marine)  
 Δ MTBF determined by Siemens norm SN 29500 at full load current and 40 °C

	1606-XLP60BQ	1606-XLP60BQT	1606-XLP72E	1606-XLP90B	1606-XLP90E-2
<b>Output Volts/Watts</b>	12...15V/54 W	12...15V/54 W	24...28V/72 W	12...15V/90 W	24...28V/90 W
<b>Input Voltage (47...63 Hz)</b>	100...240V	100...240V	100...120/220...240V AC manual select; 220...375V DC	100...120/220...240V AC; 220...375V DC	2Ø, 380...480V AC
<b>Operational Range</b>	85...264V AC	85...264V AC	85...132/184...264V AC		323...552V AC
<b>Hold-up Time</b>	>113 ms (230V AC) >25 ms (120V AC)	>113 ms (230V AC) >25 ms (120V AC)	>40 ms (230V AC) >25 ms (100V AC)	>40 ms (230V AC) >20 ms (196V AC, 100V AC)	>52 ms (400V) >93 ms (480V)
<b>Rated Input Current</b>	<0.91 A (110V AC) <0.54 A (230V AC)	<0.97 A (110V AC) <0.61 A (230V AC)	<1.6 A (100V AC) <0.8 A (220V AC)	<1.9 A	<0.42 A (400V) <0.36 A (480V)
<b>Efficiency</b>	typ. 87.2 %	typ. 87.6 %	typ. 89%	typ. 88.5%	typ. 89%
<b>Output Voltage</b>	12...15V	12...15V	24...28V 24.5V preset (at 2.9 A)	12...15V Preset at 12V	24...28V Preset at 24.5V
<b>Rated Output Current</b>	4.5 A (@ 12V), 3.6 A (@ 15V)	4.5 A (@ 12V), 3.6 A (@ 15V)	3 A (@ 24V), 2.6 A (@ 28V)	7.5 A (@ 12V), 6 A (@ 15V)	3.75 A (@ 24V), 3.2 A (@ 28V)
<b>Ripple/Noise</b>	<50 mV <sub>pp</sub>	<50 mV <sub>pp</sub>	<50 mV <sub>pp</sub>	<50 mV <sub>pp</sub>	<50 mV <sub>pp</sub>
<b>Operating Temperature Range (T<sub>amb</sub>)</b>	-10...+70 °C 60...70 °C: 1.4 W/°C derating	-40...+70 °C 60...70 °C: 1.4 W/°C derating	-10...+70 °C >60 °C: 1.5 W/K derating	-10...+70 °C >60 °C: 1 W/K derating	-10...+70 °C >60 °C: 2 W/K derating
<b>Non-Operating Temperature Range</b>	-40...+85 °C				
<b>MTBF<sup>Δ</sup></b>	—	—	appr. 600 000 hours	appr. 500 000 hours	appr. 500 000 hours
<b>Dimensions (W x H x D)</b>	45 x 75 x 91 mm	45 x 75 x 91 mm	45 x 75 x 91 mm	73 x 75 x 103 mm	73 x 75 x 103 mm
<b>Weight</b>	250 g	250 g	260 g	360 g	360 g
<b>Certifications/Standards</b> ★	1, 2, 3, 4, 5, 6	1, 2, 3, 4, 5, 6	1, 2, 3, 4, 5, 6, 9	1, 2, 3, 4, 5, 6, 7, 9	1, 2, 3, 4, 5, 6, 7, 9
<b>Special Features</b>	NEC Class 2 power supply	NEC Class 2 power supply Operation down to -40 °C	NEC Class 2 power supply; ABS/GL/RINA (Marine); Class 1 Div. 2	NEC Class 2 power supply; ABS/GL/RINA (Marine); Class 1 Div. 2	NEC Class 2 power supply; ABS/GL/RINA (Marine)

★ 1) = CE, 2) = UL 508 (cULus LISTED), 3) = UL 1950 (cURus), 4) = CSA C22.2, No. 60950, 5) Safety standards = IEC/EN 60950, EN 50178, 6) EMC standards = EN 55011 (Class B), EN 55022 (Class B), EN 61000-6-2, 7) EMC standards = EN 61000-3-2 (A14), EN 50081-1, 9)ABS/GL/RINA (Marine)  
 Δ MTBF determined by Siemens norm SN 29500 at full load current and 40 °C









## Bulletin 1606-XLP

	1606-XLP95E	1606-XLP100E	1606-XLP100F	1606-XLP100E-2
<b>Output Volts/Watts</b>	24...28V/95 W	24...28V/100 W	48...56V/100 W	24...28V/100 W
<b>Input Voltage (47...63 Hz)</b>	100...120/220...240V AC auto select; 220...375V DC			2Ø, 380...480V AC
<b>Operational Range</b>	85...132/184...264V AC			323...552V AC
<b>Hold-up Time</b>	>40 ms (230V AC) >20 ms (100V AC)			>48 ms (400V) >85 ms (480V)
<b>Rated Input Current</b>	<2.0 A (100V AC) <0.95 A (220V AC)	<2.1 A (100V AC) <1.0 A (220V AC)		<0.46 A (400V) <0.40 A (480V)
<b>Efficiency</b>	typ. 90%		typ. 91%	typ. 89%
<b>Output Voltage</b>	24...28V 24.5V preset		48...56V 48V preset	24...28V Preset at 24.5V
<b>Rated Output Current</b>	3.9 A (@ 24.5V), 3.2 A (@ 28V)	4.2 A (@ 24.5V), 3.6 A (@ 28V)	2.1 A (@ 48V), 1.8 A (@ 56V)	4.2 A (@ 24V), 3.6 A (@ 28V)
<b>Power Boost</b>	—	—	—	—
<b>Ripple/Noise</b>	<50 mV <sub>pp</sub>	<50 mV <sub>pp</sub>	<50 mV <sub>pp</sub>	<50 mV <sub>pp</sub>
<b>Operating Temperature Range (T<sub>amb</sub>)</b>	-10...+70 °C >60 °C: 2 W/K derating			
<b>Non-Operating Temperature Range</b>	-40...+85 °C			
<b>MTBF<sup>Δ</sup></b>	appr. 500 000 hours			
<b>Dimensions (W x H x D)</b>	73 x 75 x 103 mm			
<b>Weight</b>	360 g			
<b>Certifications/Standards <sup>★</sup></b>	1, 2, 3, 4, 5, 6, 7	1, 2, 3, 5, 6, 9	1, 2, 3, 5, 6, 9	
<b>Special Features</b>	NEC Class 2 power supply; Class 1 Div. 2	Single/parallel operation (inclined characteristic) select on front panel; ABS/GL/RINA (Marine); Class 1 Div. 2; Semi F47	Single/parallel operation (inclined characteristic) select on front panel; ABS/GL/RINA (Marine)	

★ 1) = CE, 2) = UL 508 (cULus LISTED), 3) = UL 1950 (cURus), 4) = CSA C22.2, No. 60950, 5) Safety standards = IEC/EN 60950, EN 50178, 6) EMC standards = EN 55011 (Class B), EN 55022 (Class B), EN 61000-6-2, 7) EMC standards = EN 61000-3-2 (A14), EN 50081-1, 9) ABS/GL/RINA (Marine)

Δ MTBF determined by Siemens norm SN 29500 at full load current and 40 °C

1606-XL Single Phase Specifications







						
	1606-XL60D	1606-XL180B	1606-XL480EP	1606-XL480EPT	1606-XL480GP	1606-XL480F
<b>Output Volts/Watts</b>	24V/60 W	12...15V/180 W	24...28V/480 W		36...43V/480 W	48...56V/480 W
<b>Input Voltage (47...63 Hz)</b>	100...120/200...240V AC manual select; 160...375V DC	100...120/220...240V AC 240...375V DC	100...120/200...240V AC			
<b>Operational Range</b>	85...132/176...264V AC	85...132/176...264V AC	85...132/184...264V AC			
<b>Hold-up Time</b>	>20 ms (196V AC)	>81 ms (230V AC) >84 ms (120V AC) >45 ms (100V AC)	30 ms (120/230V AC)		>27 ms (230V AC)	30 ms (230V AC)
<b>Rated Input Current</b>	<1.3 A (115V)/<0.7A (230V)	<5A (115V)/<2.3 A (230V)	10 A (115V)/5 A (230V)			
<b>Efficiency</b>	typ. 87.5%	typ. >87%	typ. 90.5%		typ. 92%	typ. 93%
<b>Output Voltage</b>	24V	12...15V Preset at 12V	24...28V Front panel potentiometer		36...43V Front panel potentiometer	48...56V Front panel potentiometer
<b>Rated Output Current</b>	2.5 A	15 A (@ 12V), 12 A (@ 15V)	20 A (@ 24V), 18 A (@ 28V)		13.3 A (@ 36V), 11.2 A (@ 43V)	10 A (@ 48V), 8.6 A (@ 56V)
<b>Power Boost</b>	—	18 A	25 A (22 A)		16.6 A (14 A)	12.5 A (10.7 A)
<b>Ripple/Noise</b>	<25 mV <sub>pp</sub>	<50 mV <sub>pp</sub>	< 20 mV <sub>pp</sub> (single operation) <40 mV <sub>pp</sub> (parallel operation)		<30 mV <sub>pp</sub> (single operation) <80 mV <sub>pp</sub> (parallel operation)	<40 mV <sub>pp</sub> (single operation) <80 mV <sub>pp</sub> (parallel operation)
<b>Operating Temperature Range (T<sub>amb</sub>)</b>	-10...+70 °C >60 °C with derating	0...70 °C >60 °C with derating	0...+70 °C >60 °C with derating			
<b>Non-Operating Temperature Range</b>	-40...+85 °C	0...70 °C >60 °C with derating	-40...+85 °C			
<b>MTBF*</b>	740 000 hours	<425 000 hours	519 000 hours			
<b>Dimensions (W x H x D)</b>	49 x 124 x 102 mm	120 x 124 x 102 mm	220 x 124 x 102 mm			
<b>Weight</b>	460 g	980 g	2500 g			1800 g
<b>Certifications/Standards*</b>	1, 2, 3, 4, 5, 6, 7	1, 2, 3, 4, 5, 6	1, 2, 3, 4, 5, 6, 7			1, 2, 3, 4, 5, 6
<b>Special Features</b>	NEC Class 2 power supply; Semi F47	—	PFC choke; Overload behavior selectable; (hiccup/continuous current); ‡	PFC choke; ‡	Selectable single/parallel operation (inclined characteristic); PFC choke; ‡	‡

\* 1) = CE, 2) = UL 508 (cULus LISTED), 3) = UL 1950 (cURus), 4) = CSA C22.2, No. 60950, 5) Safety standards = IEC/EN 60950, EN 50178, 6) EMC standards = EN 55011 (Class B), EN 55022 (Class B), EN 61000-6-2, 7) EMC standards = EN 61000-3-2 (A14), EN 50081-1

‡ Low inrush current

\* MTBF determined by Siemens norm SN 29500 at full load current and 40 °C

1606-XL Three Phase Specifications

						
	1606-XL120E-3	1606-XL240E-3 and 1606-XL240E-3C	1606-XL480F-3H	1606-XL720E-3	1606-XL960E-3	1606-XL960E-3S
<b>Output Volts/Watts</b>	24...28V/120 W	24...28V/240 W	48...56V/480 W	24...28V/720 W	24...28V/960 W	
<b>Input Voltage (47...63 Hz)</b>	3Ø, 400...500V AC wide range; 450...820V DC	3Ø, 400...500V AC wide range; 450...820V DC	3Ø, 400V AC; 450...700V DC	3Ø, 400...500V AC wide range; 450...820V DC	3Ø, 400...500V AC wide range	
<b>Operational Range</b>	340...576V AC		340...479V AC	340...576V AC		
<b>Hold-up Time</b>	>16 ms (3Ø 400V AC) >10 ms (2Ø 400V AC)	>24 ms (3Ø 400V AC) >20 ms (2Ø 400V AC)	>11 ms	>10 ms (3Ø 400V AC)	>15 ms (3Ø 400V AC)	
<b>Rated Input Current</b>	3 x 0.5 A	3 x 0.8/0.7 A @ 400/500V	3 x 1.5 A	3 x 2.0 A	3 x 3.0 A	
<b>Efficiency</b>	typ. 89%	typ. 92%	typ. 92%	typ. 92.5%	typ. 92.5%	
<b>Output Voltage</b>	24...28V 24.5V preset	24...28V 24.5V preset	48...56V 48.1V preset	24...28V front panel potentiometer	24...28V front panel potentiometer	
<b>Rated Output Current</b>	5 A (@ 24V), 4.3 A (@ 28V)	10 A (@ 24V), 8.6 A (@ 28V)	10 A (@ 48V), 9 A (@ 56V)	30 A (@ 24V), 26 A (@ 28V)	40 A (@ 24V), 35 A (@ 28V)	
<b>Power Boost</b>	6 A	12 A (up to 288 W)	12.5 A	33 A	45 A	
<b>Ripple/Noise</b>	<25 mV <sub>PP</sub>	<30 mV <sub>PP</sub>	<50 mV <sub>PP</sub>	<20 mV <sub>PP</sub> (single operation) <40 mV <sub>PP</sub> (parallel operation)	<50 mV <sub>PP</sub>	
<b>Operating Temperature Range (T<sub>amb</sub>)</b>	-10...+70 °C >60 °C with derating	0...+70 °C >60 °C with derating		0...+70 °C >60 °C with derating		
<b>Non-Operating Temperature Range</b>	-40...+85 °C			-40...+85 °C		
<b>MTBF</b>	410 000 hours	543 000 hours (3Ø), 525 000 hours (2Ø)	310 000 hours	425 000 h @ 400V AC, 360 000 h @ 480V AC	305 000 hours	268 000 hours
<b>Dimensions (W x H x D)</b>	73 x 124 x 117 mm	89 x 124 x 117 mm	220 x 124 x 102 mm	240 x 124 x 112 mm	275 x 124 x 117 mm	
<b>Weight</b>	730 g	980 g	1800 g	2000 g	3300 g	
<b>Certifications/Standards</b>	1, 2, 3, 4, 5, 6, 7					
<b>Special Features</b>	PFC choke	Overload behavior selectable (FUSE Mode/continuous current); 2-phase operation admissible, Single/parallel operation (inclined characteristic); PFC choke; ‡	Single/parallel operation (inclined characteristic) selectable (jumper); PFC choke; ‡	PFC choke; ‡	Single/parallel operation (inclined characteristic) selectable (jumper); passive load sharing; PFC choke; ‡	Parallel operation through active current sharing; Output signals (Power-Fail, Shut-Down, internal current measurement, overtemperature warning); PFC choke; ‡

\* 1) = CE, 2) = UL 508 (cULus LISTED), 3) = UL 1950 (cURus), 4) = CSA C22.2, No. 60950, 5) Safety standards = IEC/EN 60950, EN 50178, 6) EMC standards = EN 55011 (Class B), EN 55022 (Class B), EN 61000-6-2, 7) EMC standards = EN 61000-3-2 (A14), EN 50081-1

‡ Low inrush current

♣ MTBF determined by Siemens norm SN 29500 at full load current and 40 °C

⌘ Because this catalog number ends with "C", it indicates the device has conformal coating.

**"DC Ok" Output**

**Function:** Indicating whether the unit is operating properly. Output can directly energize a relay or a control light.  
**Signaling:** Output signal is at a "high" level (24V, current source) in normal operation (no overload, overheating, short circuit). When the output switches to "low" level (no power at output), Vout remains for 5 ms (nominal) at nominal load.  
**Connection (signal common):** Connection is made with respect to the "Signal GND" terminal (signal output).  
**Important:** Do not connect to the power output (terminals + and -).  
**Permissible load:** resistance - min. 300 Ω, e.g. 24V relay, control lights (LEDs need no series resistance), Evaluation logic.  
**For 5V signal:** In order to receive a 5V signal: switch a 5V Zener diode (0.5 W) and 1 kΩ resistance in parallel between this output and the "Signal GND" terminal.

**"Thermal Alarm" Output**

**Function:** Output gives warning shortly before and while overtemperature state occurs. Output can directly control a relay or a control light.  
**Signaling:** Output signal is at a "high" level (24V, current source) in normal operation (no overtemperature). At overtemperature, the output switches to "low". Only when the temperature in the unit increases further will the unit reduce its output current (power output).  
**Connection and permissible load:** same as for "DC ok" output.

**"Current Monitor" Output**

**Function:** Measuring the output current (power output). Output signal is proportional to the output current of the unit.  
**Connection:** Made with respect to the "Signal GND" terminal (signal output).  
**Important:** Do not connect to the power output (terminals + and -).  
**Signaling:**  
 Voltage measuring: Voltage at signal output is 1V per 10 A output current (Ri(voltmeter) > 100 k ohm )  
 Current measurement: Current at signal output is 1 mA per 10 A output current (Ri(ammeter) < 100 W)

**"Current Balance" In-/Output**

**Function:** Using these terminals, parallel operating units ensure an equal load sharing (active balancing). Balancing also works reliably with decoupling diodes at the power output (redundancy).  
**Connection:** Connect together "Current Balance" outputs of all units involved.  
**Important:** Signal common here is the - terminal of the power output, not the "Signal GND". Do not connect the "Signal GND" terminals to each other!

**"Signal GND" Terminal**

**Function:** Grounding terminal for all signal terminals (not for "Current Balance").  
**Connection instructions:** Do not connect this terminal with terminals + or - of the unit (not even over a load: risk of overload). Do not connect this terminal with terminals of other units (not even with the "Signal GND" terminal of another unit).  
**Permissible load:** Maximum current load: 0.3 A. Terminal is fused internally with a self-healing fuse (polyswitch).

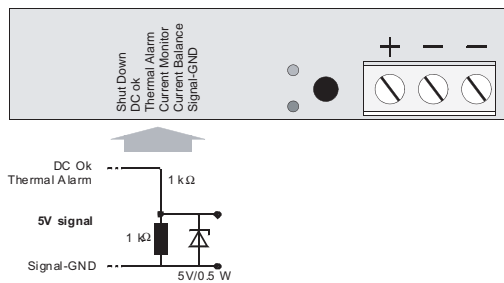

**Bulletin 1606 Special Modules**

	1606-XLDC40A	1606-XLDC92D	1606-XLSDNET4	1606-XLSDNET8	1606-XLEDNET3
<b>Output Volts/Watts</b>	24V/40 W	24V/92 W	24V/91 W	24V/192 W	24V...28V/80 W
<b>Input Voltage (47...63 Hz)</b>	18...36V DC	24V DC	100...240V AC; 110...300V DC	AC 100...240V 110...300V	DC 100...120V AC/200...240 V AC
<b>Operational Range</b>	16...40V DC	14...32.4V DC	85...264V AC 88...360V DC	85...276 V AC 88...375 V DC	90...132V AC/180...264V AC
<b>Hold-up Time</b>	18...36V DC	18...36V DC	43 ms (120V AC) 77 ms (240V AC)	38 ms (120V AC) 41 ms (240V AC)	>60 ms (120V) >244 ms (240V)
<b>Rated Input Current</b>	<2.9 A	<5.5 A	1.1 A (100V AC) 0.5 A (240V AC)	2.3 A (100V AC) 1.0 A (240V AC)	1.24 A (100V AC) 0.68 A (240V AC)
<b>Efficiency</b>	typ. 82%	typ. 90.3%	typ. 92.4%	typ. 92.7%	typ. 90%
<b>Output Voltage</b>	5.1V	24V	24V	24V	24...28V
<b>Rated Output Current</b>	8 A	3.8 A	3.8 A	8 A	3.3 A @ 24V 2.9 A @ 28V
<b>Ripple/Noise</b>	<50 mV <sub>pp</sub>	<50 mV <sub>pp</sub>	< 50 mV <sub>pp</sub>	< 50 mV <sub>pp</sub>	<50 mV <sub>pp</sub>
<b>Operating Temperature Range (T<sub>amb</sub>)</b>	0...+70 °C >60 °C with derating	-25...+70 °C >60 °C with derating	-25...+70 °C >60 °C with derating	-25...+70 °C >60 °C with derating	-25...+70 °C, >60 °C with derating
<b>Non-Operating Temperature Range</b>	-25...+85 °C	-40...+85 °C	-40...+85 °C	-25...+70 °C >60 °C with derating	-40...+85 °C
<b>MTBF<sup>Δ</sup></b>	> 510 000 hours	-	>581 000 hours	>831 000 hours	>700 000 hours
<b>Dimensions (W x H x D)</b>	49 x 124 x 102 mm	32 x 124 x 102 mm	40 x 124 x 117 mm	60 x 124 x 117 mm	32 x 124 x 102 mm
<b>Weight</b>	470 g	410 g	620 g	900 g	430 g
<b>Certifications/Standards</b> ★	1, 2, 3, 5, 6, 7		1, 2, 3, 5, 6, 7	1, 2, 3, 5, 6, 7	1, 2, 3, 4, 5, 6, 7
<b>Special Features</b>	—		NEC Class 2 power supply; Active PFC; ODVA Approved; Class 1 Div. 2; Semi F47	Active PFC; ODVA Approved; Class 1 Div. 2; Semi F47	NEC Class 2 power supply; ODVA Approved; Class 1 Div. 2; Semi F47

★ 1) = CE, 2) = UL 508 (cULus LISTED), 3) = UL 1950 (cURus), 4) = CSA C22.2, No. 60950, 5) Safety standards = IEC/EN 60950, EN 50178, 6) EMC standards = EN 55011 (Class B), EN 55022 (Class B), EN 61000-6-2, 7) EMC standards = EN 61000-3-2 (A14), EN 50081-1  
 Δ MTBF determined by Siemens norm SN 29500 at full load current and 40 °C

Bulletin 1606 Redundant Power Supplies

	N+1 Redundancy	N+1 Redundancy	N+1 Redundancy
	1606-XL60DR	1606-XL120DR	1606-XL240DR
<b>Output Volts/Watts</b>	24V/60 W	24V/120 W	24V/240 W
<b>Input Voltage (47...63 Hz)</b>	100...120V/200...240V AC manual select; 160...375V DC	100...120/200...240V AC manual select; 210...375V DC	AC 100...120/200...240V manual select; DC 240...375V
<b>Operational Range</b>	—	85...132/176...264V AC	85...132/176...264 V AC
<b>Hold-up Time</b>	>20 ms (AC 196V)	>37 ms (AC 196V)	>25 ms (AC 196V)
<b>Rated Input Current</b>	<1.3 A (115V)/<0.7 A (230V)	<2.6 A (115V)/<1.4 A (230V)	<6 A (115V)/<2.8 A (230V)
<b>Efficiency</b>	typ. 86.5%	typ. 89%	typ. 89%
<b>Output Voltage</b>	24V	24V	24V
<b>Rated Output Current</b>	2.5 A	5 A	10 A
<b>Power Boost</b>	—	6 A	12 A
<b>Ripple/Noise</b>	<30 mV <sub>PP</sub>	<30 mV <sub>PP</sub>	<30 mV <sub>PP</sub>
<b>Operating Temperature Range (T<sub>amb</sub>)</b>	-10...+70 °C >60 °C with derating	-10...+70 °C >60 °C with derating	0...+70 °C >60 °C with derating
<b>Non-Operating Temperature Range</b>	-10 °C...+70 °C >60 °C with derating	-40...+85 °C	-40...+85 °C
<b>MTBF<sup>Δ</sup></b>	700 000 hours	480.000 hours	390.000 hours
<b>Dimensions (W x H x D)</b>	49 x 124 x 102 mm	64 x 124 x 102 mm	120 x 124 x 102 mm
<b>Weight</b>	470 g	620 g	980 g
<b>Certifications/Standards</b> ★	1, 2, 3, 5, 6	1, 2, 3, 5, 6, 7	1, 2, 3, 5, 6
<b>Special Features</b>	RDY relay contact; N+1 redundancy; plug connectors; NEC Class 2 power supply	RDY relay contact; N+1 redundancy; plug connectors	RDY relay contact; N+1 redundancy; plug connectors

★ 1) = CE, 2) = UL 508 (cULus LISTED), 3) = UL 1950 (cURus), 4) = CSA C22.2, No. 60950, 5) Safety standards = IEC/EN 60950, EN 50178, 6) EMC standards = EN 55011 (Class B), EN 55022 (Class B), EN 61000-6-2, 7) EMC standards = EN 61000-3-2 (A14), EN 50081-1  
 Δ MTBF determined by Siemens norm SN 29500 at full load current and 40 °C

Bulletin 1606 Redundancy Module

	N+1 Redundancy	N+1 Redundancy	N+1 Redundancy	N+1 Redundancy		N+1 Redundancy	N+1 Redundancy
	1606-XLRED20-30	1606-XLRED40	1606-XLPRED	1606-XLSRED	1606-XLERED	1606-XLSRED40	1606-XLSRED80
<b>Output Volts/Watts</b>	30 A Dual redundancy module	40 A Single redundancy module	8 A Dual redundancy	10 A Dual redundancy		20 A Dual redundancy	40 A Dual redundancy
<b>Input Voltage (47...63 Hz)</b>	DC 24V (max. 35V)		DC 10...60V	DC 10...60V		24...28 V DC	24...28 V DC
<b>Operational Range</b>	18...36 V DC		10...60V DC	10...60V DC		24...28 V DC	24...28 V DC
<b>Rated Input Current</b>	20...30 A (max. 35 A)	0...40 A (max. 50 A)	Single input: 8 A max. Dual input: 16 A max. total	Single input: 10 A max. Dual input: 20 A max. total		Single input: 20 A max. Dual input: 40 A max. total	Single input: 40 A max. Dual input: 80 A max. total
<b>Output Voltage</b>	V <sub>in</sub> -0.5V typ.	V <sub>in</sub> -0.6V typ.	V <sub>in</sub> -0.9V typ.	V <sub>in</sub> -0.9V typ.		V <sub>in</sub> -2.15V typ.	V <sub>in</sub> -2.7V typ.
<b>Rated Output Current</b>	20...30 A (max. 35 A)	0...40 A (max. 50 A)	0...10 A	0...20 A		0...40 A	0...80 A
<b>Operating Temperature Range (T<sub>amb</sub>)</b>	-10 °C...+70 °C		-40 °C...+70 °C >60 °C with derating	-25 °C...+70 °C >60 °C with derating		-25 °C...+70 °C >60 °C with derating	-25 °C...+70 °C >60 °C with derating
<b>Dimensions (W x H x D)</b>	48 x 124 x 102 mm	48 x 124 x 117 mm	45 x 75 x 91 mm	32 x 124 x 102 mm	32 x 124 x 117 mm	36 x 124 x 127 mm	46 x 124 x 127 mm
<b>Weight</b>	625 g	646 g	136 g	290 g	350 g	340 g	440 g
<b>Certifications/Standards</b> ★	1, 2, 3, 6		1, 2, 3, 6	1, 2, 3, 6		1, 2, 3, 6	1, 2, 3, 6
<b>Special Features</b>	Dual redundancy module for 2x35 A; N+1 redundancy	Single redundancy module for 2.5-50 A; N+1 redundancy	Redundancy for DC 10...60V applications; ABS/GL/RINA (Marine); Class 1 Div. 2	Redundancy for DC 10...60V applications; Class 1 Div. 2	Redundancy for DC 10...60V applications; Class 1 Div. 2; DC OK	Redundancy for DC 24...28V applications; Class 1 Div. 2	Redundancy for DC 24...28V applications; Class 1 Div. 2

★ 1) = CE, 2) = UL 508 (cULus LISTED), 3) = UL 1950 (cURus), 4) = CSA C22.2, No. 60950, 5) Safety standards = IEC/EN 60950, EN 50178, 6) EMC standards = EN 55011 (Class B), EN 55022 (Class B), EN 61000-6-2, 7) EMC standards = EN 61000-3-2 (A14), EN 50081-1  
 Δ MTBF determined by Siemens norm SN 29500 at full load current and 40 °C

## Bulletin 1606-XLS UPS

	UPS	UPS	UPS	UPS
	1606-XLS240-UPS	1606-XLS240-UPSC	1606-XLS240-UPSD	1606-XLS240-UPSE
<b>Output Volts/Watts</b>	22.5V...30V/240 W	22.25V/240 W	22.25V and 12V/240 W	
<b>Input Voltage (47...63 Hz)</b>	24V DC (22.5...30V DC)	24V DC (22.5...30V DC)	24V DC (22.5...30V DC)	
<b>Rated Input Current Voltage stand-by mode/charging mode</b>	typ. 0.12 A/ max. 1.3 A	typ. 0.12 A/ max. 1.3 A	—	typ. 0.12 A/ max. 1.3 A
<b>Operational Range</b>	22.5...30V DC	22.5...30V DC	22.5...30V DC	22.5...30V DC
<b>Hold-up Time</b>	battery dependent			
<b>Output Voltage</b>	22.4V	22.25V	22.25V	22.25V
<b>Rated Output Current</b>	10 A	10 A	10 A	10 A
<b>Power Boost</b>	15 A	15 A	15 A	15 A
<b>Operating Temperature Range (T<sub>amb</sub>)</b>	-25...+60 °C		-25...+40 °C	
<b>Non-Operating Temperature Range</b>	-40...+85 °C		-20...+50 °C	
<b>MTBF<sup>Δ</sup></b>	886 000 hours	886 000 hours	788 000 hours	886 000 hours
<b>Dimensions (W x H x D)</b>	49 x 124 x 117	123 x 124 x 119	49 x 124 x 117	49 x 124 x 117
<b>Weight</b>	530 g	2850 g	650 g	545 g
<b>Certifications/Standards</b> ★	1, 2, 3, 5, 6			
<b>Special Features</b>	Inhibit replacement battery buffering			

★ 1) = CE, 2) = UL 508 (cULus LISTED), 3) = UL 1950 (cURus), 4) = CSA C22.2, No. 60950, 5) Safety standards = IEC/EN 60950, EN 50178, 6) EMC standards = EN 55011 (Class B), EN 55022 (Class B), EN 61000-6-2, 7) EMC standards = EN 61000-3-2 (A14), EN 50081-1  
<sup>Δ</sup> MTBF determined by Siemens norm SN 29500 at full load current and 40 °C

## Bulletin 1606-XLSBUFFER

	Buffer Module	Buffer Module
	1606-XLSBUFFER 24	1606-XLSBUFFER 48
<b>Output Volts</b>	22.5V DC	45V DC
<b>Input Current</b>	80 mA typ. 600 mA max.	40 mA typ. 500 mA max.
<b>Hold-up Time</b>	200 ms @ 20 A	100 ms @ 20 A
<b>Output Voltage</b>	V <sub>in</sub> -1V: 22.5V fixed	V <sub>in</sub> -2V: 45V fixed
<b>Rated Output Current</b>	20 A	20 A
<b>Operating Temperature Range (T<sub>amb</sub>)</b>	-25...+70 °C	
<b>Non-Operating Temperature Range</b>	-40...+85 °C	
<b>Dimensions (W x H x D)</b>	64 x 124 x 102 mm	64 x 124 x 102 mm
<b>Weight</b>	740 g	740 g
<b>Certifications/Standards</b> ★	1, 2, 3, 5, 6	
<b>Special Features</b>	Selectable buffered voltage; §	

★ 1) = CE, 2) = UL 508 (cULus LISTED), 3) = UL 1950 (cURus), 4) = CSA C22.2, No. 60950, 5) Safety standards = IEC/EN 60950, EN 50178, 6) EMC standards = EN 55011 (Class B), EN 55022 (Class B), EN 61000-6-2, 7) EMC standards = EN 61000-3-2 (A14), EN 50081-1

§ Low inrush current

**Approximate Dimensions - Accessories**

Approximate dimensions are shown in millimeters (in.) unless otherwise indicated. Dimensions are not to be used for manufacturing purposes.

**Cat. No. 1606-XLB, Back of Panel Mounting Bracket**

For use with Bulletin 1606-XLE and -XLS Power Supplies below 20 A.

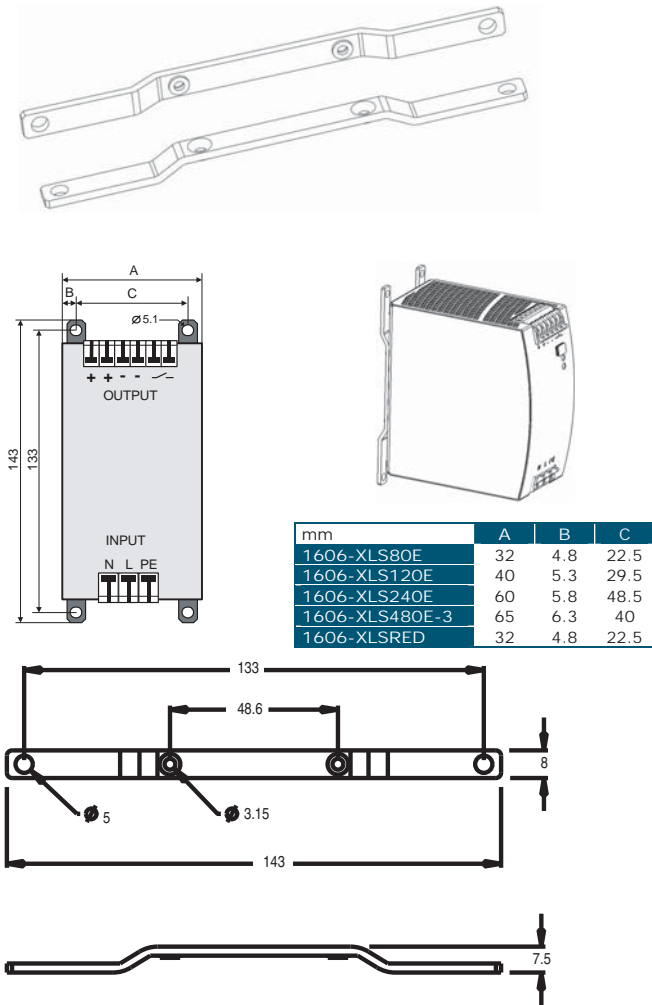

**Cat. No. 1606-XLC, Back of Panel Mounting Bracket**

For use with Bulletin 1606-XLE and -XLS Power Supplies 20 A and above.

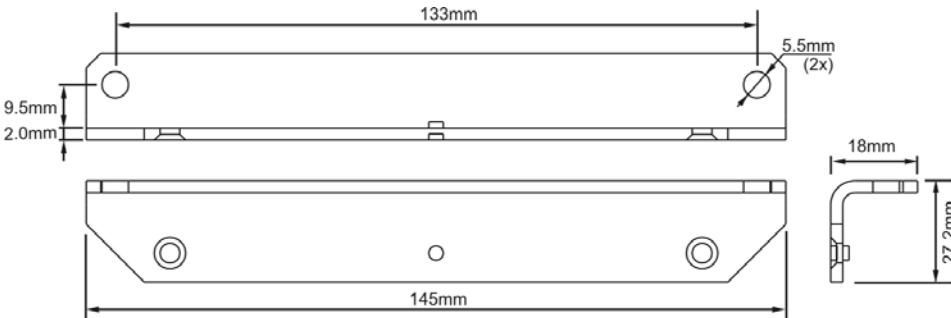

Application Information

1606-XL Redundancy Capabilities

The 1606-XL family has two cost effective methods for providing redundancy to applications that are critical and can not risk failure.

1606-XL60DR, XL120DR and XL240DR Redundant Power Supplies

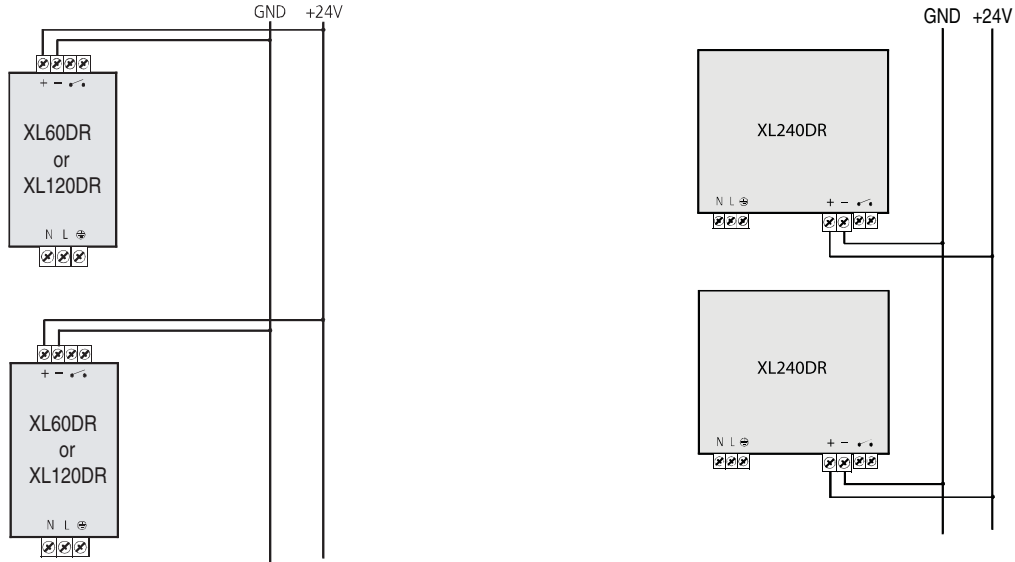

The 1606-XL60DR, XL120DR and XL240DR are enhanced versions of the standard power supplies.

- Each device has internal diodes which provide isolation against DC bus problems corrupting working supplies.
- Provides "DC OK" output relay to allow remote monitoring of DC power status.
- Utilizes pluggable terminals for easy installation.

1606-XLRED20-30 and 1606-XLRED40 Redundancy Modules

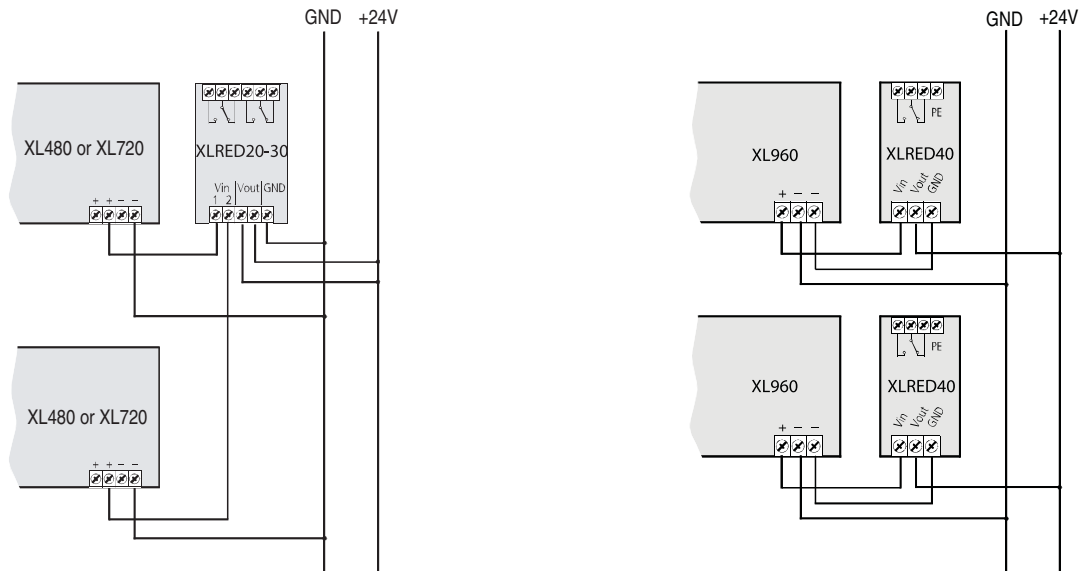

Extensive Diagnostic & Monitoring Functions

Protective Features:

- Wrong battery voltage (24V instead of 12V)
- Wrong battery polarity
- Too high ambient temperature
- Output overload or output short-circuit
- Deep discharge (battery) protection
- Wrong polarity on input terminals
- Over-voltage protection (malfunctioning of the internal regulation loops)

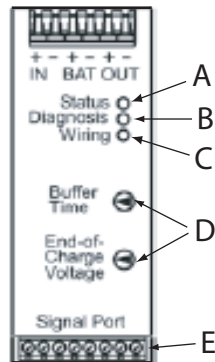

**A - Status LED (green):**

- Ready: Battery is charged > 85%, no wiring failure is recognized, input voltage is sufficient and inhibit signal is not active.
- Charging: Battery is charging and battery capacity is below 85%.
- Buffering: Unit is in buffer mode.

**B - Diagnosis LED (yellow):**

- Overload: Output has switched off, due to long overload in buffer mode or due to high temperatures.
- Replace battery: Indicates a battery which failed the battery quality test (SCH test). Battery should be replaced soon.
- Buffer time expired: Output has switched off due to settings of buffer time. The signal will be stored and displayed for 15 minutes.
- Inhibit active: Indicates that buffering is disabled due to an active inhibit signal.

**C - Check wiring LED (red):**

- Check wiring between DC UPS and battery, as well as the battery itself. Also indicates when input voltage is not in range.

**D - Adjustor:**

- Buffer time limiter: User accessible switch which limits the maximum buffer time in a buffer event, to save battery capacity.
- End-of-charge voltage: User accessible potentiometer which sets the end-of-charge voltage. Adjust the potentiometer according to the expected battery temperature.

**E - Signal contacts:****Ready (contact 1-2):**

Contact is closed when battery is charged more than 85%, no wiring failure is recognized, input voltage is sufficient, and inhibit signal is not active.

**Buffering (contact 3-4):**

Contact is closed when unit is buffering.

**Replace battery (contact 5-6):**

Contact is closed when input voltage is sufficient and battery quality test (SCH test) indicates a negative result, three times in a row.

**Inhibit input (contact 7&8):**

The inhibit input disables buffering. In normal mode, a static signal is required. In buffer mode, a pulse with a minimum length of 250 ms is required to stop buffering. The inhibit is stored and can be reset by cycling the input voltage.

## Important User Information

Read this document and the documents listed in the additional resources section about installation, configuration, and operation of this equipment before you install, configure, operate, or maintain this product. Users are required to familiarize themselves with installation and wiring instructions in addition to requirements of all applicable codes, laws, and standards.

Activities including installation, adjustments, putting into service, use, assembly, disassembly, and maintenance are required to be carried out by suitably trained personnel in accordance with applicable code of practice.

If this equipment is used in a manner not specified by the manufacturer, the protection provided by the equipment may be impaired.

In no event will Rockwell Automation, Inc. be responsible or liable for indirect or consequential damages resulting from the use or application of this equipment.

The examples and diagrams in this manual are included solely for illustrative purposes. Because of the many variables and requirements associated with any particular installation, Rockwell Automation, Inc. cannot assume responsibility or liability for actual use based on the examples and diagrams.

No patent liability is assumed by Rockwell Automation, Inc. with respect to use of information, circuits, equipment, or software described in this manual.

Reproduction of the contents of this manual, in whole or in part, without written permission of Rockwell Automation, Inc., is prohibited.

## Documentation Feedback

Your comments will help us serve your documentation needs better. If you have any suggestions on how to improve this document, complete this form, publication [RA-DU002](#), available at <http://www.rockwellautomation.com/literature/>.

Allen-Bradley, Rockwell Software, Rockwell Automation, and LISTEN. THINK. SOLVE are trademarks of Rockwell Automation, Inc.  
Trademarks not belonging to Rockwell Automation are property of their respective companies.

Rockwell Otomasyon Ticaret A.Ş., Kar Plaza İş Merkezi E Blok Kat:6 34752 İçerenköy, İstanbul, Tel: +90 (216) 5698400

**[www.rockwellautomation.com](http://www.rockwellautomation.com)**

---

### Power, Control and Information Solutions Headquarters

Americas: Rockwell Automation, 1201 South Second Street, Milwaukee, WI 53204-2496 USA, Tel: (1) 414.382.2000, Fax: (1) 414.382.4444  
Europe/Middle East/Africa: Rockwell Automation NV, Pegasus Park, De Kleetlaan 12a, 1831 Diegem, Belgium, Tel: (32) 2 663 0600, Fax: (32) 2 663 0640  
Asia Pacific: Rockwell Automation, Level 14, Core F, Cyberport 3, 100 Cyberport Road, Hong Kong, Tel: (852) 2887 4788, Fax: (852) 2508 1846