



S30A-6011DB

S3000 Professional CMS

PRODUCT PORTFOLIO

SICK
Sensor Intelligence.



Ordering information

Type	Part no.
S30A-6011DB	1026401

The system plug has to be ordered separately!

Other models and accessories → www.sick.de/S3000_Professional_CMS



Detailed technical data

Features

Protective field range	5.5 m
Warning field range	49 m (20 m at 20 % reflectivity)
Distance measuring range	49 m
Number of field sets	8
Scan angle	190°
Resolution	30 mm, 40 mm, 50 mm, 70 mm, 150 mm, configurable
Angular resolution	0.5°, 0.25°, depending on range and resolution
Response time	60 ms ¹⁾
Protective field supplement	100 mm
Number of multiple samplings	2 ... 16, configurable
Delay of automatic reset	2 s ... 60 s, configurable

¹⁾ Depending on basic response time and multiple sampling.

Safety-related parameters

Type	Type 3 (IEC 61496)
Safety integrity level	SIL2 (IEC 61508), SILCL2 (EN 62061)
Category	Category 3 (EN ISO 13849)
Performance level	PL d (EN ISO 13849)
PFHd (mean probability of a dangerous failure per hour)	8.0×10^{-8} (EN ISO 13849)
T _M (mission time)	20 years (EN ISO 13849)
Safe state in the event of a fault	At least one OSSD is in the OFF state.

Functions

External device monitoring (EDM)	✓
Simultaneous monitoring	✓
Static protective field switching	✓

Dynamic protective field switching	✓
Contour as a reference	✓
Integrated configuration memory	✓
Measured data output	✓
Expanded measured data output (CMS)	✓
Safe SICK device communication via EFI/SDL	✓

Interfaces

Connection type	System plug with or without connecting cable
Configuration method	PC with CDS (Configuration and Diagnostic Software)
Configuration and diagnostics interface	RS-232
Transmission rate	9.6 kBaud, 19.2 kBaud, 38.4 kBaud
Data interface	RS-422
Transmission rate	≤ 500 kBaud
Safe SICK device communication via EFI/SDL	
Transmission rate	≤ 500 kBaud
Cable length	≤ 50 m
Conductor cross-section	0.34 mm ²
Fieldbus, industrial network	
Integration via EFI gateways	CANopen, Ethernet TCP/IP, PROFIBUS DP, PROFIBUS PROFI-safe, PROFINET PROFI-safe ¹⁾

¹⁾ For a suitable EFI-gateway see modules and gateways in the accessory section of connection systems.

Electrical data

Protection class	II (EN 50178)
Supply voltage V_s	24 V DC (16.8 V DC ... 28.8 V DC)
Power consumption	≤ 0.8 A ¹⁾ ≤ 2.3 A ²⁾
Inputs	
External device monitoring (EDM)	1
Reset/restart	1
Static control inputs	2 4
Dynamic control inputs (incremental encoder)	2
Outputs	
Safety outputs (OSSD)	2 x 500 mA
Diagnostic outputs	1 x 100 mA

¹⁾ At 24 V DC without output load.

²⁾ At 24 V DC including maximum output load.

Mechanical data

Dimensions (W x H x D)	155 mm x 185 mm x 160 mm
Weight	3.3 kg
Housing material	Aluminum die cast

Housing color	RAL 1021 (yellow)
Front screen material	Polycarbonat
Front screen surface finish	Outside with scratch-resistant coating

Ambient data

Enclosure rating	IP 65 (EN 60529)
Ambient operating temperature	-10 °C ... +50 °C
Storage temperature	-25 °C ... +50 °C
Vibration resistance	5 g, 10 Hz ... 150 Hz (EN 61496-1, CLC/TS 61496-3)
Shock resistance	10 g, 16 ms (EN 61496-1, CLC/TS 61496-3)

Other information





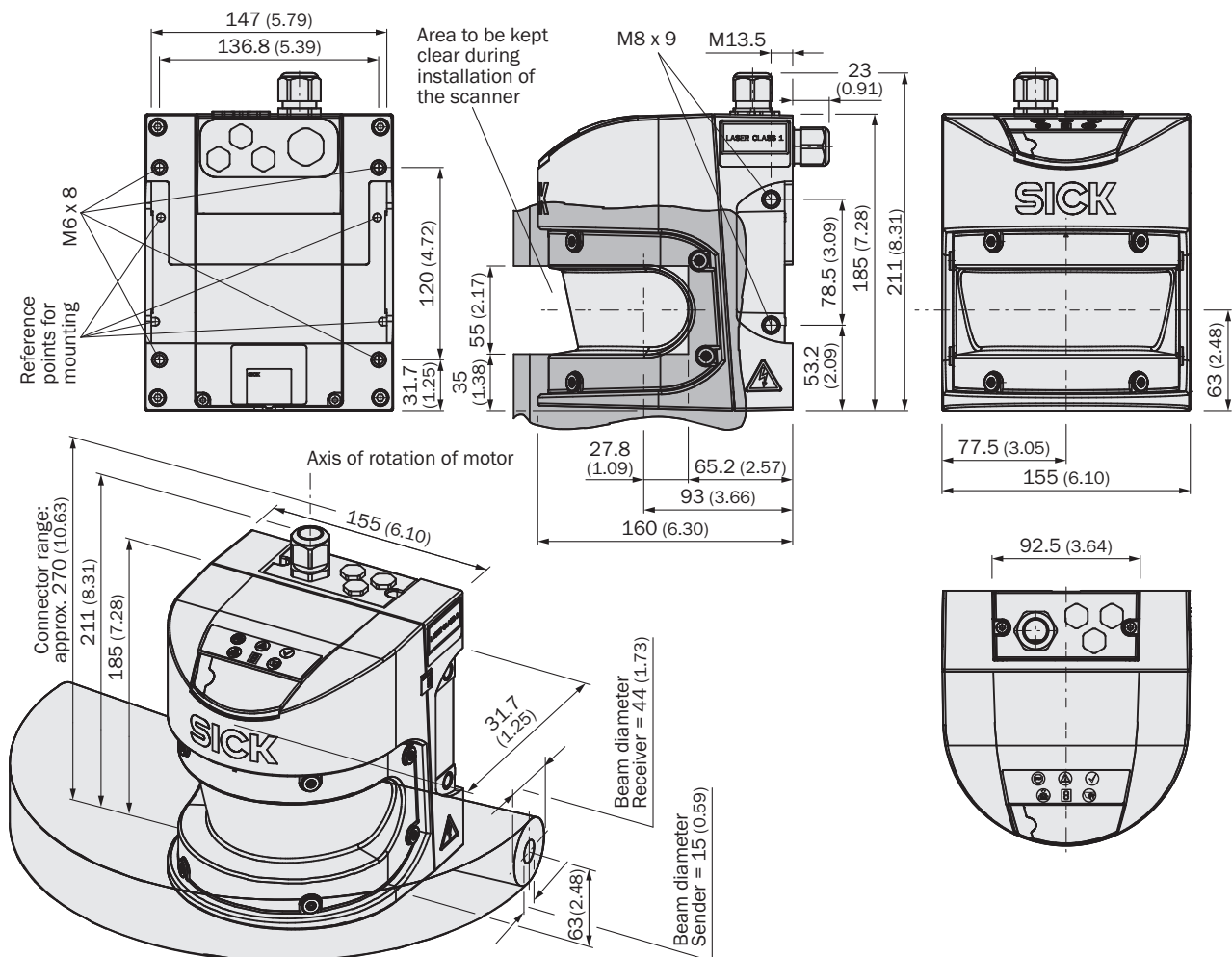

Type of light	Pulsed laser diode
Wave length	905 nm
Reflectivity	1.8 % ... > 1,000 %, reflectors
Laser class	1 (21 CFR 1040.10 and 1040.11, IEC 60825-1)

Dimensional drawing (dimensions in mm (inch))



Recommended accessories

Other models and accessories → www.sick.de/S3000_Professional_CMS

	Brief description	Type	Part no.
Mounting brackets and mounting plates			
	1 piece, mounting bracket for direct mounting, from the rear, on wall or machine, not adjustable	Mounting kit 1	2015623
	1 piece, mounting bracket for rear mounting on wall or machine, adjustable longitudinal and lateral axes, only in conjunction with mounting kit 1 (2015623)	Mounting kit 2	2015624
	1 piece, mounting bracket for rear mounting on wall, floor, or machine, adjustable longitudinal and lateral axes, only in conjunction with mounting kit 1 (2015623) and 2 (2015624)	Mounting kit 3	2015625
	1 piece, Mounting bracket, heavy design, with protective hood, for floor mounting, adjustable longitudinal and lateral axes via alignment plate, adjustable height, steel, painted	Mounting kit heavy duty	2080350
Plug connectors and cables			
	Head A: Cable Head B: Cable Cable: PVC, shielded Fitting for EFI connections	EFI connecting cable	6029448
	Head A: male connector, M8, 4-pin, straight Head B: male connector, USB-A, straight Cable: PVC, unshielded, 2 m For connecting the configuration connection to the USB interface on the PC	DSL-8U04G02M025KM1	6034574
	Head A: male connector, M8, 4-pin, straight Head B: male connector, USB-A, straight Cable: PVC, unshielded, 10 m For connecting the configuration connection to the USB interface on the PC	DSL-8U04G10M025KM1	6034575
	Head A: system plug Cable: without cable Not for use with incremental encoders, integrated configuration memory	SX0A-A0000B	2023797

Australia

Phone +61 3 9457 0600
1800 33 48 02 - tollfree
E-Mail sales@sick.com.au

Belgium/Luxembourg

Phone +32 (0)2 466 55 66
E-Mail info@sick.be

Brasil

Phone +55 11 3215-4900
E-Mail marketing@sick.com.br

Canada

Phone +1 905 771 14 44
E-Mail information@sick.com

Česká republika

Phone +420 2 57 91 18 50
E-Mail sick@sick.cz

China

Phone +86 4000 121 000
E-Mail info.china@sick.net.cn
Phone +852-2153 6300
E-Mail ghk@sick.com.hk

Danmark

Phone +45 45 82 64 00
E-Mail sick@sick.dk

Deutschland

Phone +49 211 5301-301
E-Mail info@sick.de

España

Phone +34 93 480 31 00
E-Mail info@sick.es

France

Phone +33 1 64 62 35 00
E-Mail info@sick.fr

Great Britain

Phone +44 (0)1727 831121
E-Mail info@sick.co.uk

India

Phone +91-22-4033 8333
E-Mail info@sick-india.com

Israel

Phone +972-4-6801000
E-Mail info@sick-sensors.com

Italia

Phone +39 02 27 43 41
E-Mail info@sick.it

Japan

Phone +81 (0)3 5309 2112
E-Mail support@sick.jp

Magyarország

Phone +36 1 371 2680
E-Mail office@sick.hu

Nederland

Phone +31 (0)30 229 25 44
E-Mail info@sick.nl

Norge

Phone +47 67 81 50 00
E-Mail sick@sick.no

Österreich

Phone +43 (0)22 36 62 28 8-0
E-Mail office@sick.at

Polska

Phone +48 22 837 40 50
E-Mail info@sick.pl

România

Phone +40 356 171 120
E-Mail office@sick.ro

Russia

Phone +7-495-775-05-30
E-Mail info@sick.ru

Schweiz

Phone +41 41 619 29 39
E-Mail contact@sick.ch

Singapore

Phone +65 6744 3732
E-Mail sales.gsg@sick.com

Slovenija

Phone +386 (0)1-47 69 990
E-Mail office@sick.si

South Africa

Phone +27 11 472 3733
E-Mail info@sickautomation.co.za

South Korea

Phone +82 2 786 6321/4
E-Mail info@sickkorea.net

Suomi

Phone +358-9-25 15 800
E-Mail sick@sick.fi

Sverige

Phone +46 10 110 10 00
E-Mail info@sick.se

Taiwan

Phone +886-2-2375-6288
E-Mail sales@sick.com.tw

Türkiye

Phone +90 (216) 528 50 00
E-Mail info@sick.com.tr

United Arab Emirates

Phone +971 (0) 4 8865 878
E-Mail info@sick.ae

USA/México

Phone +1(952) 941-6780
1 800-325-7425 - tollfree
E-Mail info@sickusa.com

More representatives and agencies
at www.sick.com