

KS20-FSS-P-C/O4

The KS is a key driven electrical switch designed for machine control circuits. This type of isolator should be used for short term, off load isolation. The KS is manufactured from either brass or stainless steel making it ideal for use in normal and harsh corrosive environments where the lock is subject to heavy use. The unit is able to be mounted into an existing panel or for surface mounting within its own polycarbonate IP65 rated enclosure.

Operation

The Castell KS powersafe electrical key switch is used for machine isolation in order to protect the hazardous area from access while power is on.

KS20 powersafe electrical switch, back on panel mount

① Key is trapped, while power is on.

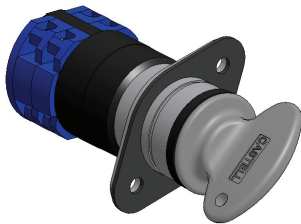

② Turn and remove key to switch the power off by changing the contacts arrangement.

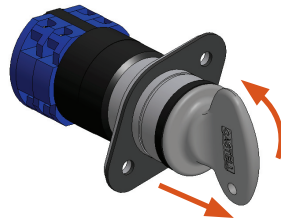

③ Key is free, power is off.

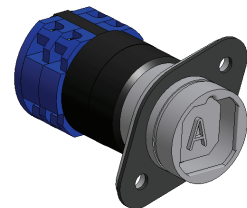

1. While the power is on and a machine is running, the key is trapped in the KS key switch.
2. By turning and removing the key out of the switch, the contacts condition in the KS changes, switching the power off.
3. The key now can be taken to open the door lock and gain access to the machine area.

The KS is available for different switching loads as KS20, KS32 or KS63 (20, 32 or 63 amps power isolation respectively). Please refer to drawing on page 6 for more details.

The KS comes with 4 contacts as standard with contacts arrangements as 2NO/2NC, 4NC, but auxiliary set of contacts are available on request.

The KS is available as a back of panel mount version or as a front of panel mount with an enclosure. Please refer to drawing on page 6 for more details.

Usage

The KS powersafe electrical key switch is designed to be part of a safety system and is used to isolate the power releasing a key which is then used to gain access to a hazardous area via an access interlock such as the AI, AIE or Salus.



The KS key switch is not designed for security purposes.

No hazardous substances were used in the manufacture of this product. The product can be disposed of in standard waste.

Installation

Front of panel units should be mounted to a flat surface using 4 off suitable fixing screws. Offer up back box of enclosure in desired position and use mounting holes as a drilling template.

Back of panel units should be mounted to a flat surface using suitable fasteners (please refer to drawing on page 4 for more details). The lock face should be sealed to the panel for ingress protection.

Cables should be connected to the switch (via the cable gland for front of panel) in accordance with the applicable wiring diagrams. Ensure that the unit is bonded for earth continuity (see drawing on page 4 for more installation details).



IMPORTANT:

The interlock should be mounted using anti-tamper fasteners to prevent unauthorised removal.



The KS range of switches must be installed by a competent and qualified person who has read and understood these instructions. Please retain this document in your technical file.

Maintenance

Periodic visual checks should be carried out by the site manager / safety officer.
Do not lubricate lock barrel with oil or grease, use CK Dry Powder Graphite if necessary.



In case of defects being detected please contact your nearest Castell Support Department for further actions.
Please see Contact section for contact details.

Technical Data

Temperature rating	-25 °C ice free to 55 °C
Type of mounting	Surface or panel mount using suitable fasteners (please refer to drawing on page 4 for more details)
Weight	KS20: Front of board mount = 0,8 kg / back on board mount = 0,6 kg
	KS32: Front of board mount = 0,8 kg / back of board mount = 1 kg
	KS63: 1,5 kg
Material	Brass/Stainless steel
Enclosure	Polycarbonate IP65
Power isolation	20A, 32A, and 63A options available
Motor Isolation (AC Values)	KS20: AC-23A 7.5kW or AC-3 5.5kW
	KS32: AC-23A 15kW or AC-3 11kW
	KS63: AC-23A 30kW or AC-3 18.5kW
Switch approvals	CE, CCC
MTTF Certification	Available on request

Application

A typical application of KS powersafe electrical switch is machine guarding. It is usually used in combination with an access interlock such as the Salus for part body access or an access interlock with an exchange key for full body access control such as AIE.

The KS breaks the machine safety circuit, ensuring a machine is shut down when the key is turned and removed. The key can then be taken to the Salus automativ access interlock to enable access to the machine.

The machine cannot be restarted until the door is closed, the bolt is trapped in the access interlock and the key is removed and taken to the KS key switch.

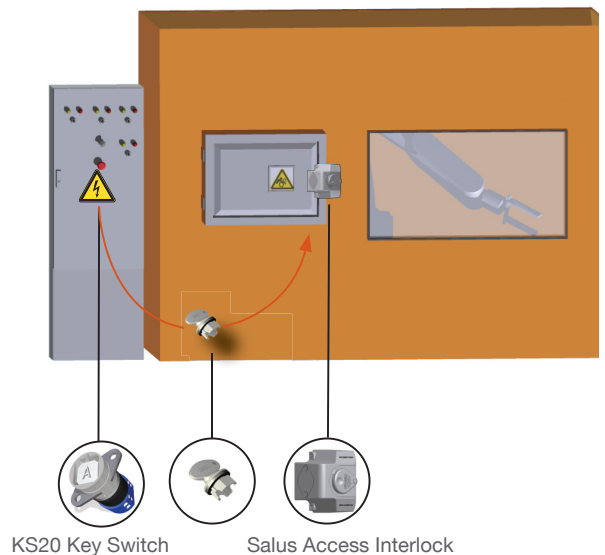

EC-Declaration

We, the manufacturers, declare that the components, detailed herein and placed on the market, comply with all the essential health and safety requirements applying to them.

Empowered signatory:

Mr T.C. Whelan
Managing Director



Drawing

Dimensions:
in mm

Note: For safe mounting, use security screws

KS20, FOB (Front of board, enclosure)

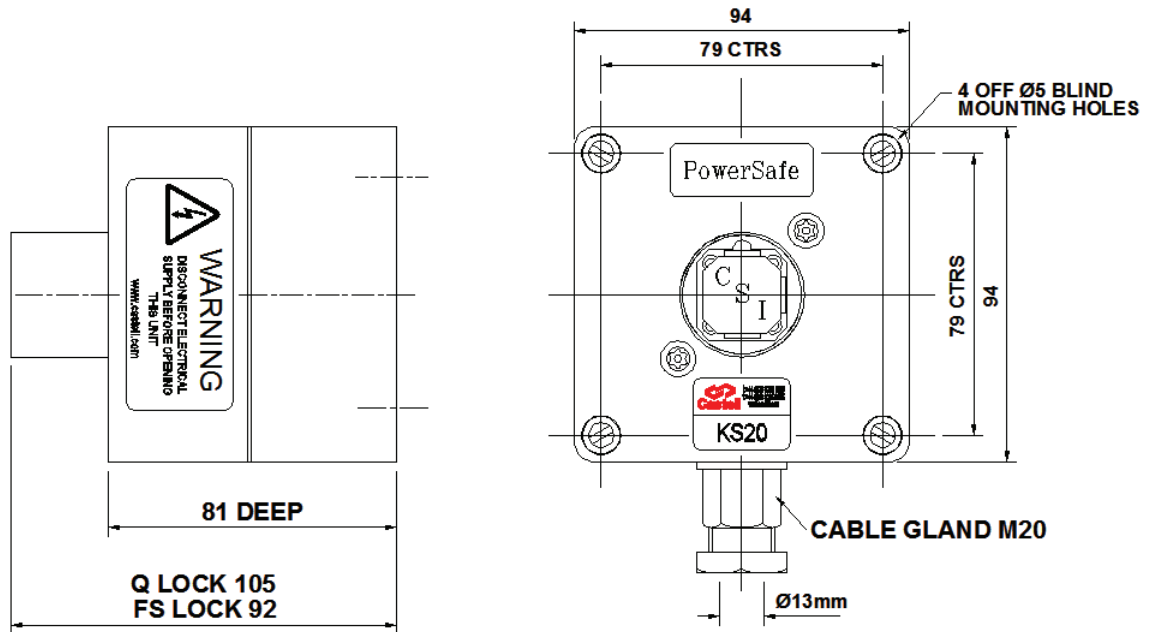

KS20, BOB (Back of board)

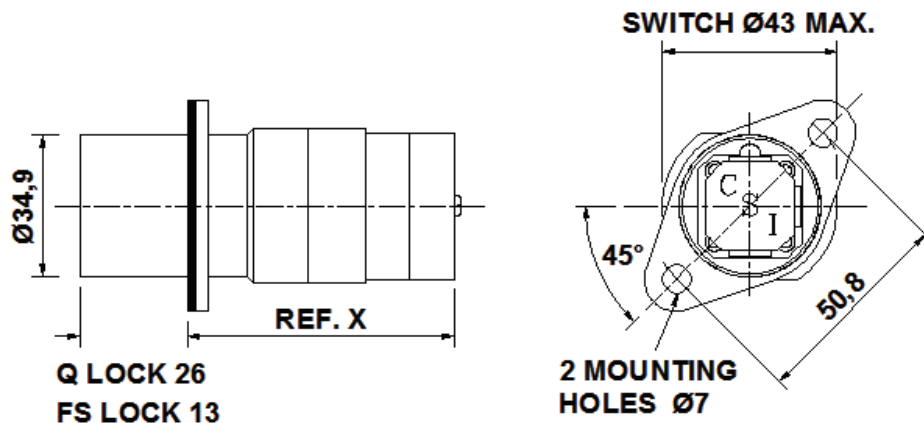

DIMENSION REFERENCE 'X'	
No. OF POLES	LENGTH
4 POLES	66,6mm
6 POLES	76,1mm
8 POLES	85,6mm
10 POLES	95,1mm
12 POLES	104,6mm

While every effort has been made to ensure the accuracy of the information provided, no liability can be taken for any errors or omission. Castell Safety International Limited reserves the right to alter specifications and introduce improvements without prior notice.

Wiring Diagram

Key Free, Switch off

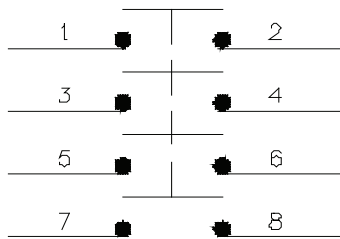

KEY FREE – SWITCH OFF

Key Free, 2 NO/2NC

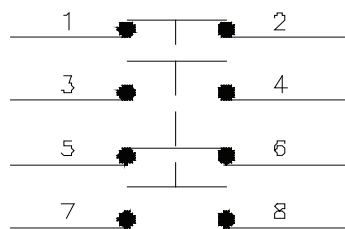

KEY FREE – 2 N/O & 2 N/C

Order Information

	Product Type	1	2	3	4	5	6
Part Number	KS						
Example	KS	20	FS	B	P	C/O	4
		7					
		ABC					

1	Isolation	20 amps 32 amps 63 amps
2	Lock portion type	FS ⁽¹⁾ / Q ⁽¹⁾
3	Material	B = Brass / S = Stainless steel
4	Mounting	P = Panel mount (back of board) F = Front of board mount, with enclosure
5	Contacts arrangement in normal position	C/O = NO/NC arrangement (contacts closed/opened) CC = NC arrangement (all contacts closed)
6	Contacts number	4 (standard)
7	Lock portion symbol	FS ⁽¹⁾ up to 3 characters / Q ⁽¹⁾ up to 6 characters

(1) **FS - Lock type** Up to 3 characters **Q - Lock type** Up to 6 characters



Special construction available upon enquiry

Accessories

	Product	Part number
	Flip Cap	FLIP-S

Contact Information

Castell Safety International Ltd.
The Castell Building
217 Kingsbury Road
London, England NW9 9PQ

t: +44 (0) 20 8200 1200
f: +44 (0) 20 8905 9378
e: uksales@castell.com

Castell Safety International Ltd.
Oskar-Jäger-Strasse 137
50825 Köln
Germany

t: +49 (0) 221 1649 794
f: +49 (0) 221 1649 795
e: vertrieb@castell.com

Castell Interlocks Inc.
Suite 800
150 N Michigan Avenue,
Chicago, Illinois 60601
USA

t: +1.312.360.1516
f: +1.312.268.5174
e: ussales@castell.com

Castell Safety China
Building 1, No. 123,
Lane 1165, Jindu Road,
Minhang District,
Shanghai 201108, China.

t: +86 21 61519023
f: +86 21 61519030
e: chinasales@castell.com

While every effort has been made to ensure the accuracy of the information provided, no liability can be taken for any errors or omission. Castell Safety International Limited reserves the right to alter specifications and introduce improvements without prior notice.