

# IEC Contactor Specifications

Bulletin Numbers 100/104-K, 100/104-C, 100/104S-C, 100/104-E, 100S-E, 100/104-D, 100S-D, 100-G, 100Q-C

Topic	Page
Product Line Overview	3
IEC Contactors	3
Safety Contactors	4
100-K/104-K Miniature Contactors	5
Product Selection	5
Accessories	10
Specifications	13
Life-Load Curves	17
Approximate Dimensions	19
100-C/104-C, 100S-C/104S-C, 100Q-C Contactors	21
Product Selection—100-C/104-C Contactors	21
Product Selection—100S-C/104S-C Safety Contactors	28
Product Selection—100Q-C Capacitor-switching Contactors	38
Accessories	40
Renewal Parts	45
Specifications	47
Life-Load Curves	58
Maximum Operating Rates	64
Approximate Dimensions	68
100-E/104-E, 100S-E/104S-E Contactors	73
Product Selection—100-E/104-E Contactors	73
Product Selection—100S-E Safety Contactors	74
Accessories	75
Renewal Parts	78
Specifications	80
Approximate Dimensions	97

Topic	Page
100-D/104-D, 100S-D Contactors	101
Product Selection—100-D/104-D Contactors	101
Product Selection—100S-D Safety Contactors	105
Accessories	108
Renewal Parts	113
Specifications	115
Life-Load Curves	125
Approximate Dimensions	127
100-G Contactors	129
Product Selection—100-G Contactors	129
Accessories	130
Renewal Parts	131
Specifications	132
Life-Load Curves	137
Permissible Switching Rate	139
Approximate Dimensions	141



## Additional Resources





These documents contain additional information concerning related products from Rockwell Automation.

Resource	Description
Industrial Automation Wiring and Grounding Guidelines, publication <a href="#">1770-4.1</a>	Provides general guidelines for installing a Rockwell Automation industrial system.
Product Certifications website, <a href="https://www.rockwellautomation.com/global/certification/overview.page">https://www.rockwellautomation.com/global/certification/overview.page</a>	Provides declarations of conformity, certificates, and other certification details.



You can view or download publications at <http://www.rockwellautomation.com/literature/>. To order paper copies of technical documentation, contact your local Allen-Bradley distributor or Rockwell Automation sales representative.

# Product Line Overview

## IEC Contactors

					
Bulletin No.	100-K/104-K	100-C/104-C	100-E/104-E	100-D/104-D	100-G
Screw Terminals	✓	✓	Thru-hole	Thru-hole, threaded (630...860 A)	Thru-hole
Spring Terminals	✓ (5...9 A)	✓ (9...16 A)	—	—	—
Max. Current $I_e$	12 A	97 A	2650 A	860 A	1200 A
Current Rating	5...12 A	9...97 A	116...2650 A	115...860 A	550...1200 A
Features	<ul style="list-style-type: none"> <li>Mini-contactors</li> <li>Uniform panel mounting dimensions</li> <li>Panel mounting or mounting on 35 mm DIN Rail</li> <li>AC or DC coil control</li> <li>Made of environmentally friendly materials</li> </ul>	<ul style="list-style-type: none"> <li>Panel mounting or mounting on 35 mm DIN Rail</li> <li>AC or DC coil control</li> <li>Reversible coil terminals (line or load side)</li> <li>Common accessories</li> <li>Made of environmentally friendly materials</li> </ul>	<ul style="list-style-type: none"> <li>Panel mounting</li> <li><b>E116...E370</b> AC/DC electronic coil with optional PLC interface</li> <li><b>E400...E2650</b> AC/DC with PLC interface</li> <li>Made of environmentally friendly materials</li> </ul>	<ul style="list-style-type: none"> <li>Panel mounting only</li> <li>Made of environmentally friendly materials</li> <li>AC or DC coil control (conventional or electronic)</li> <li>Integrated PLC interface (electronic coil)</li> </ul>	<ul style="list-style-type: none"> <li>Panel mounting</li> <li>AC or DC coil control</li> <li>Horizontal or vertical interlock</li> <li>Latching</li> <li>4th pole</li> </ul>
Contacts	3 power poles with internal N.O. or N.C. auxiliary contact, or 4 power poles. Optional front-mounted 2- or 4-pole external auxiliary contact block.	3 power poles with internal N.O. or N.C. auxiliary contact or 4 power poles (9...23 A). Optional front- or side-mounted 1-, 2- or 4-pole external auxiliary contact block.	3 main poles with 2 auxiliary contacts (1 N.O. and 1 N.C.) Optional side-mounted 2-pole external auxiliary contact block.	3 power poles with external N.O. and N.C. side-mounted auxiliary contact. Optional side-mounted 2-pole external auxiliary contact blocks	3 power poles with N.O. and N.C. front-mounted auxiliary contact. Optional 4th pole and auxiliary contacts
Coil Voltages	AC = 24...600V, 50/60Hz DC = 12...250V	AC = 12...600V, 50/60Hz DC = 9...250V	24...500V 50/60 Hz/DC	<p><b>Conventional Coils</b> Cat. Nos. 100-D115...D180 AC: 24...550V 50 Hz, 24...600V 60Hz, 100...277V 50/60Hz DC: 24...250V DC</p> <p><b>Electronic Coils</b> Cat. Nos. 100-D115...D300 AC: 24...500V 50/60 Hz DC: 24...255V DC</p> <p><b>Cat. Nos. 100-D420</b> AC: 42...500V 50/60 Hz DC: 48...255V DC</p> <p><b>Cat. Nos. 100-D630...D860</b> AC: 100...500V 50/60 Hz DC: 110...255V DC</p>	AC = 110...480V, 50/60Hz DC = 100...440V
Optional Overload Relays	Electronic or bimetallic	Electronic or bimetallic	Electronic	Electronic	Electronic
Optional Accessories	<ul style="list-style-type: none"> <li>Front-mount auxiliary contacts</li> <li>Surge suppressors</li> <li>Electronic timers</li> <li>Mechanical interlocks</li> </ul>	<ul style="list-style-type: none"> <li>Front or side-mount auxiliary contacts</li> <li>Surge suppressors</li> <li>Electronic or pneumatic timers</li> <li>Mechanical interlocks</li> <li>Mechanical latches</li> </ul>	<ul style="list-style-type: none"> <li>Side-mount auxiliary contacts</li> <li>Mechanical interlocks</li> <li>Terminal lugs</li> <li>Terminal shields</li> <li>Connecting bars</li> </ul>	<ul style="list-style-type: none"> <li>Side-mount auxiliary contacts</li> <li>Surge suppressors</li> <li>IP20 terminal blocks</li> <li>Terminal shields</li> <li>Terminal covers</li> <li>Connecting components</li> <li>Terminal lugs</li> <li>Mechanical/electrical interlocks</li> </ul>	<ul style="list-style-type: none"> <li>Auxiliary contact</li> <li>4th pole</li> <li>Vertical interlock</li> <li>Horizontal interlock</li> <li>Mechanical latch</li> </ul>
Standards/Certifications	<ul style="list-style-type: none"> <li>UL</li> <li>CSA</li> <li>IEC</li> <li>CE Marked</li> <li>CCC</li> </ul>	<ul style="list-style-type: none"> <li>UL</li> <li>CSA</li> <li>IEC</li> <li>CE Marked</li> <li>CCC</li> </ul>	<ul style="list-style-type: none"> <li>EN/IEC</li> <li>CE Marked</li> <li>cULus</li> <li>CCC</li> <li>EAC</li> <li>C-tick</li> </ul>	<ul style="list-style-type: none"> <li>UL</li> <li>CSA</li> <li>IEC</li> <li>CE Marked</li> <li>CCC(115...180 A - conventional coil; 140...860 A - electronic coil)</li> </ul>	<ul style="list-style-type: none"> <li>UL</li> <li>CSA</li> <li>IEC</li> <li>CE Marked</li> </ul>

# Safety Contactors

			
Bulletin No.	<b>1005-C/1045-C</b>	<b>1005-E</b>	<b>1005-D</b>
Screw Terminals	✓	Thru-hole	Thru-hole, threaded (630...860 A)
Max. Current $I_e$	97 A	750 A	860 A
Current Rating	9...97 A	116...750 A	115...860 A
Features	<ul style="list-style-type: none"> <li>Positively guided/mechanically linked auxiliary contacts</li> <li>Front-mounted auxiliary contacts:                             <ul style="list-style-type: none"> <li>Permanently fixed</li> <li>Protective cover to prevent manual operation</li> <li>Red contact housing for easy identification</li> <li>Incorporates IEC 947-5-1 "Mechanically Linked" symbol</li> <li>Optional gold-plated bifurcated versions</li> </ul> </li> <li>AC and DC operating coils</li> <li>SUVA third-party certification</li> </ul>	<ul style="list-style-type: none"> <li>Mirror contact performance on auxiliary contacts</li> <li>Red N.C. low-power auxiliary contact used for feedback circuit</li> <li>SUVA third-party certification</li> <li>AC/ DC operating coils</li> <li>"Mirror Contact" symbol on front</li> </ul>	<ul style="list-style-type: none"> <li>Mirror contact performance on auxiliary contacts, which are required in feedback circuit for modern safety applications.</li> <li>The N.C. auxiliary contacts will not change state when a power contact welds.</li> <li>SUVA third-party certification</li> <li>AC and DC operating coils</li> <li>"Mirror Contact" symbol</li> </ul>
Contacts	3 main poles with N.C. mechanically linked or mirror feedback contacts	3 main poles with N.C. mirror feedback contacts	3 main poles with N.C. mirror feedback contacts
Coil Voltages	<p>AC = 12...600V, 50/60Hz DC = 12...250V</p>	<p>24...500V 50/60 Hz/DC</p>	<p><b>Conventional Coils</b> <b>Cat. Nos. 1005-D115...D180</b> AC: 24...550V, 50 Hz; 24...600V, 60Hz; 100...277V, 50/60Hz DC: 24...250V</p> <p><b>Electronic Coils</b> <b>Cat. Nos. 1005-D115...D300</b> AC: 24...500V, 50/60 Hz DC: 24...255V</p> <p><b>Cat. Nos. 1005-D420</b> AC: 42...500V 50/60 Hz DC: 48...255V</p> <p><b>Cat. Nos. 1005-D630...D860</b> AC: 100...500V, 50/60 Hz DC: 110...255V</p>
Optional Accessories	<ul style="list-style-type: none"> <li>Side-mount auxiliary contacts</li> <li>Surge suppressors</li> <li>Electronic timers</li> <li>Mechanical interlocks</li> </ul>	<ul style="list-style-type: none"> <li>Side-mount auxiliary contacts</li> <li>Terminal shields</li> <li>Terminal lugs</li> <li>Terminal enlargements</li> <li>Terminal extensions</li> <li>Connection bars for 140G molded case circuit breakers, 140MG motor protection circuit breakers, and 140MG motor circuit protectors</li> </ul>	<ul style="list-style-type: none"> <li>Side-mount auxiliary contacts</li> <li>Surge suppressors</li> <li>IP20 terminal blocks</li> <li>Terminal shields</li> <li>Terminal covers</li> <li>Connecting components</li> <li>Terminal lugs</li> <li>Mechanical/electrical interlocks</li> </ul>
Standards Compliance	<ul style="list-style-type: none"> <li>EN/IEC 60947-4</li> <li>IEC 60947-5-1 Annex L — Mechanically Linked Contacts</li> <li>IEC 60947-4-1 Annex H — Mirror Contacts</li> <li>UL 508</li> <li>CSA C22.2 No. 14</li> <li>EN50205</li> </ul>	<ul style="list-style-type: none"> <li>EN/IEC 60947-4-1</li> <li>IEC 60947-4-1, Annex F — Mirror Contacts</li> <li>UL 60947-4-1</li> <li>CSA C22.2, No. 60947-4-1</li> </ul>	<ul style="list-style-type: none"> <li>EN/IEC 60947-4</li> <li>IEC 60947-4-1</li> <li>IEC 60947-4-1/A1: 2002-09, Annex F</li> <li>UL 508</li> <li>CSA C22.2, No. 14</li> </ul>
Certifications	<ul style="list-style-type: none"> <li>cULus Listed (File No. E3125; Guide NLDX, NLDX7)</li> <li>SUVA Third-Party Certified</li> <li>CE Marked</li> </ul>	<ul style="list-style-type: none"> <li>cULus Listed (File No. E41850; Guide No. NLDX, NLDX7)</li> <li>CE Marked</li> <li>CCC</li> <li>UL</li> <li>CSA</li> <li>EAC</li> <li>RCM (C-tick)</li> <li>SUVA Third-Party Certified</li> </ul>	<ul style="list-style-type: none"> <li>cULus Listed (File No. E3125; Guide No. NLDX, NLDX7)</li> <li>SUVA Third-Party Certified</li> <li>CE Marked</li> <li>CCC (115...180 A - conventional coil; 140...860 A - electronic coil)</li> </ul>

# 100-K/104-K Miniature Contactors

## Product Selection



- 3-Pole AC- and DC-Operated Contactors
- Compact size
- Same dimensions for AC and DC
- Full-voltage non-reversing and reversing contactors
- 5, 9, and 12 A contactors rated at 690V
- IP2X finger protection
- Optional integrated surge suppressor
- Compatible with Bulletin 193-K bimetallic overload relay
- Mirror contacts per IEC 60947-4-1 and mechanically linked contacts per IEC 60947-5-1 on main unit



Bulletin 100-K miniature contactors are designed for commercial and light industrial applications where panel space is at a premium. These miniature devices, while 45 mm wide, are shallower and have less panel depth requirements than standard IEC contactors.

The miniature contactors have been designed with flexibility in mind. They are available with AC or DC operating coils, several contact ratings, and optional 2- or 4-pole adder decks in a variety of auxiliary contact configurations.



## 3-Pole AC- and DC-Operated Contactors

Rated Operational Current $I_e$ [A]		Ratings for switching AC motors - AC-2, AC-3, AC-4										Auxiliary Contacts		Pkg. Qty. <sup>(1)</sup>	Cat. No.
		3-phase kW (50 Hz)				Hp (60 Hz)									
40 °C		230V	400/415V	500V	690V	1-Phase		3-Phase				N.O.	N.C.		
AC-3	AC-1					115V	230V	200V	230V	460V	575V				
<b>Screw Terminals</b>															
5	20	1.5	2.2	2.2	2.2	1/2	1	1-1/2	1-1/2	3	3	1	0	1	100-K05⊗10
												0	1		
9	20	3	4	4	4	1/2	1-1/2	2	2	5	5	1	0	1	100-K09⊗10
												0	1		
12	20	3	5.5	5.5	5.5	3/4	2	3	3	7-1/2	7-1/2	1	0	1	100-K12⊗10
												0	1		
<b>Spring Clamp Terminals</b>															
5	10	1.5	2.2	2.2	2.2	1/3	3/4	1-1/2	1-1/2	3	3	1	0	1	100-KR05⊗10
												0	1		
9	10	2.2	4	4	4	1/3	1	2	2	5	5	1	0	1	100-KR09⊗10
												0	1		

(1) May be ordered in package quantities of 20. Add letter M to the end of the cat. no. Example: 100-K09ZJ10M.

⊗ Coil voltage code — see [page 7](#).

### 4-Pole AC- and DC-Operated Contactors



Rated Operational Current $I_e$ [A]		Ratings for switching AC motors - AC-2, AC-3										Contact Configuration, Main Poles		Pkg. Qty. <sup>(1)</sup>	Cat. No.
		3-phase kW (50 Hz)				Hp (60 Hz)									
		40 °C		230V	400/415V	500V	690V	1-Phase		3-Phase					
AC-3	AC-1	115V	230V					200V	230V	460V	575V	N.O.	N.C.		
5	20	1.5	2.2	2.2	2.2	1/2	1	1-1/2	1-1/2	3	3	4	0	1	100-K05⊗400
												3	1	1	100-K05⊗300
												2	2	1	100-K05⊗200
9	20	3	4	4	4	1/2	1-1/2	2	2	5	5	4	0	1	100-K09⊗400
												3	1	1	100-K09⊗300
												2	2	1	100-K09⊗200
12	20	3	5.5	5.5	5.5	3/4	2	3	3	7-1/2	7-1/2	4	0	1	100-K12⊗400
												3	1	1	100-K12⊗300
												2	2	1	100-K12⊗200

(1) May be ordered in package quantities of 20. Add letter M to the end of the cat. no. Example: 100-K09ZJ400M.

⊗ Coil voltage code — see [page 7](#).

### Reversing AC- and DC-Operated Contactors

Bulletin 104-K reversing contactors are factory assembled and include contactors, mechanical interlock (Cat. No. 100-KMCH) and wiring kit (Cat. No. 100-KPR) for power and control circuit (electrical interlock).

Rated Operational Current $I_e$ [A]		Ratings for switching AC motors - AC-2, AC-3, AC-4										Auxiliary Contacts per Contactor <sup>(1)</sup>		Cat. No.
		3-phase kW (50 Hz)				Hp (60 Hz)								
		40 °C		230V	400/415V	500V	690V	1-Phase		3-Phase				
AC-3	AC-1	115V	230V					200V	230V	460V	575V	N.O.	N.C.	
5	20	1.5	2.2	2.2	2.2	—	—	1-1/2	1-1/2	3	3	0	1	104-K05⊗02
9	20	3	4	4	4	—	—	2	2	5	5	0	1	104-K09⊗02
12	20	3	5.5	5.5	5.5	—	—	3	3	7-1/2	7-1/2	0	1	104-K12⊗02

(1) Used for electrical interlocking

⊗ Coil voltage code — see [page 7](#).

## Coil Voltage Codes

### Coil Voltage Code for screw type terminal versions

The Cat. No. as listed is incomplete. Select a coil voltage code from the table below to complete the Cat. No. Example: 120V, 60 Hz: Cat. No. 100-K09Ø10 becomes Cat. No.100-K09D10.

AC Voltages [V]	24	110	120	230	240	400	480	600
50 Hz	—	D	—	—	—	—	—	—
60 Hz	—	—	D	—	—	—	B	VC
50/60 Hz	KJ	—	—	KF	KA	KN	—	—

DC Voltages [V]	12	24	110	125	220	250
Standard	ZQ	ZJ	ZD	ZS	ZA	ZT
with Integrated Diode	—	DJ	—	—	—	—

### Coil Voltage Code for spring clamp type terminal versions

The Cat. No. as listed is incomplete. Select a coil voltage code from the table below to complete the Cat. No. Example: 120V, 60 Hz: Cat. No. 100-KR09Ø10 becomes Cat. No.100-KR09D10.

AC Voltages [V]	24	110	120	230
50 Hz	—	D	—	—
60 Hz	—	—	D	—
50/60 Hz	KJ	—	—	KF

DC Voltages [V]	24	110
Standard	ZJ	ZD
with Integrated Diode	DJ	—

## Assignment of Contacts

Table valid for: AC / DC = 0.85...1.1 x U<sub>s</sub>, T<sub>amb</sub> = -25 °C...+60 °C, normal position (horizontal rail mounting)

### Device Combinations in Accordance with IEC 60947-1 / -4-1

Auxiliary Contact Blocks <sup>(1)</sup>		100-K Miniature Contactors (AC and DC Control)					
Circuit Diagram	Control	100-K05⊗10 100-K09⊗10 100-K12⊗10	100-K05⊗01 100-K09⊗01 100-K12⊗01	100-K05⊗400 100-K09⊗400 100-K12⊗400	100-K05⊗300 100-K09⊗300 100-K12⊗300	100-K05⊗200 100-K09⊗200 100-K12⊗200	
<b>Front Mounting</b>							
100-KFA02E		AC/DC	(2)	01 + 02 = 03 <sup>(3)</sup>	(2)	(2)(3)	—
100-KFC02		AC/DC	10 + 02 = 12	—	00 + 02 = 02	00 + 02 = 02 <sup>(3)</sup>	—
100-KFA11E		AC/DC	(2)	01 + 11 = 12	(2)	(2)	(2)
100-KFB11		AC/DC	10 + 11 = 21	—	00 + 11 = 11	00 + 11 = 11	00 + 11 = 11
100-KFC11		AC/DC	10 + 11 = 21	(2)	00 + 11 = 11	00 + 11 = 11	00 + 11 = 11
100-KFA20E		AC/DC	(2)	01 + 20 = 21	(2)	(2)	(2)
100-KFC20		AC/DC	10 + 20 = 30	(2)	00 + 20 = 20	00 + 20 = 20	00 + 20 = 20
100-KFA04E		AC/DC	(2)(3)	—	(2)(3)	—	—
100-KFC04		AC/DC	10 + 04 = 14 <sup>(3)</sup>	—	00 + 04 = 04 <sup>(3)</sup>	—	—
100-KFA13E		AC/DC	(2)	01 + 13 = 14 <sup>(3)</sup>	(2)	(2)(3)	—
100-KFC13		AC/DC	10 + 13 = 23	(2)(3)	00 + 13 = 13	00 + 13 = 13 <sup>(3)</sup>	—
100-KFA22Z		AC/DC	(2)	01 + 22 = 23 <sup>(3)</sup>	(2)	(2)(3)	—
100-KFB22		AC/DC	10 + 22 = 32	—	00 + 22 = 22	00 + 22 = 22 <sup>(3)</sup>	—
100-KFC22		AC/DC	10 + 22 = 32	(2)(3)	00 + 22 = 22	00 + 22 = 22 <sup>(3)</sup>	—
100-KFA31Z		AC/DC	(2)	—	(2)(4)	—	—









Auxiliary Contact Blocks <sup>(1)</sup>		100-K Miniature Contactors (AC and DC Control)					
Circuit Diagram	Control	100-K05⊗10 100-K09⊗10 100-K12⊗10	100-K05⊗01 100-K09⊗01 100-K12⊗01	100-K05⊗400 100-K09⊗400 100-K12⊗400	100-K05⊗300 100-K09⊗300 100-K12⊗300	100-K05⊗200 100-K09⊗200 100-K12⊗200	
100-KFC31	AC/DC		10 + 31 = 41 <sup>(4)</sup>	—	00 + 31 = 31 <sup>(4)</sup>	—	—
100-KFA40E	AC/DC		(2)	(2)	(2)	(2)	(2)
100-KFC40	AC/DC		10 + 40 = 50	(2)	00 + 40 = 40	00 + 40 = 40	00 + 40 = 40



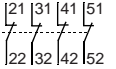
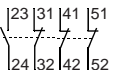
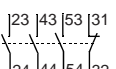
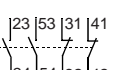
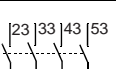

- (1) For other operating limits, please contact your local Rockwell Automation sales office or Allen-Bradley distributor
- (2) Combination possible but not recommended, due to repeating or not consecutive sequence numbering
- (3) T<sub>amb</sub> max. +40 °C
- (4) T<sub>amb</sub> max. +40 °C and only allowed for coil voltage 24V DC or 230V AC

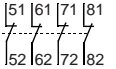
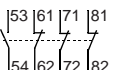
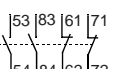
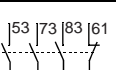
# Accessories

## Auxiliary Contact Blocks

	Description	Connection Diagrams	 		For Use With	Pkg. Qty.	Cat. No.	
			N.O.	N.C.			Screw Type Terminals	Spring Clamp Terminals
			0	2	100-K05...K12	1	100-KFC02	100-KRFC02
			1	1	100-K05...K12	1	100-KFC11	100-KRFC11
			2	0	100-K05...K12	1	100-KFC20	100-KRFC20
	<p>Front-Mounted Auxiliary Contacts</p> <ul style="list-style-type: none"> <li>Auxiliary contact blocks 2- and 4-pole versions</li> <li>Choice of contact configurations</li> <li>Snap on, no tools required</li> <li>Electronic-compatible bifurcated contacts for signals down to 15V/2 mA</li> <li>Mirror Contact performance per IEC 60947-4-1</li> </ul>		0	4	100-K05...K12	1	100-KFC04	100-KRFC04
			1	3	100-K05...K12	1	100-KFC13	100-KRFC13
			3	1	100-K05...K12	1	100-KFC31	100-KRFC31
			2	2	100-K05...K12	1	100-KFC22	100-KRFC22
			4	0	100-K05...K12	1	100-KFC40	100-KRFC40
			0	2	100/104-K, 700-K	1	100-KFA02E	100-KRFA02E
			1	1	100/104-K, 700-K	1	100-KFA11E	100-KRFA11E
			2	0	100/104-K, 700-K	1	100-KFA20E	100-KRFA20E
			0	4	100/104-K, 700-K	1	100-KFA04E	100-KRFA04E
			1	3	100/104-K, 700-K	1	100-KFA13E	100-KRFA13E
			2	2	100/104-K, 700-K	1	100-KFA22Z	100-KRFA22Z
			3	1	100/104-K, 700-K	1	100-KFA31Z	100-KRFA31Z
			4	0	100/104-K, 700-K	1	100-KFA40E	100-KRFA40E

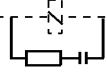
**Control Modules**



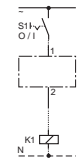

	Description		Connection Diagrams	For Use With	Pkg. Qty.	Cat. No.	
	Mechanical Interlock <ul style="list-style-type: none"> <li>For interlocking of two adjacent contactors No added width to contactor assembly</li> <li>Front mount plug-in type</li> <li>Optional auxiliary contact blocks and suppressor modules mount onto the interlock</li> </ul>			100/104-K/-KR, 700-K/-KR	1	100-KMCH	
	RC Suppressor	24...48V AC		100/104-K/-KR, 700-K/-KR	1 <sup>(1)</sup>	100-KFSC50	
		110...280V AC			1 <sup>(1)</sup>	100-KFSC280	
		380...480V AC			1 <sup>(1)</sup>	100-KFSC480	
	MOV Suppressor	12...55V AC, 12...77V DC		100/104-K/-KR, 700-K/-KR	1 <sup>(1)</sup>	100-KFSV55	
		56...136V AC, 78...180V DC				1 <sup>(1)</sup>	100-KFSV136
		137...277V AC, 181...250V DC				1 <sup>(1)</sup>	100-KFSV277
Diode Suppressor	12...250V DC		100/104-K/-KR, 700-K/-KR	1 <sup>(1)</sup>	100-KFSD250		

(1) May be ordered in package quantities of 10. Add letter M to the end of the cat. no. Example: 100-KFSC50M.

**Timers**

	Description		Connection Diagrams	For Use With	Pkg. Qty.	Cat. No.
	Solid-State Timing Element <ul style="list-style-type: none"> <li>110...250V AC or DC</li> <li>Includes 35 mm Hat Rail adapter</li> </ul>	On-Delay, 0.1...3 s		100/104-K, 700-K	10	100-KT3S
		On-Delay, 1...30 s				100-KT30S

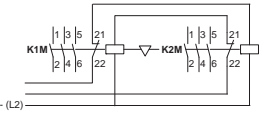
**Connecting Components**

	Description		For Use With	Pkg. Qty.	Cat. No.	
	ECO Connecting Module — 12 A <ul style="list-style-type: none"> <li>For DOL and reversing starters</li> <li>Eco-starters mount on single DIN Rail (140M on DIN Rail)</li> <li>Electrical and mechanical interconnection of 140M and 100-K contactors</li> </ul>		Connects: 140M-C circuit breakers with 100-K contactors	140M-C to 100-K	1 <sup>(1)</sup>	140M-C-PEK12
	Power Wiring Kit <ul style="list-style-type: none"> <li>For Reversing and Star/Delta combinations. Star-point bridge not included.</li> <li>Min. interruption time 50 ms</li> </ul>			100-K	1	100-KPR
	Feeder Terminal for Compact Bus Bars <ul style="list-style-type: none"> <li>Max. current 34 A</li> </ul>		Supply of compact bus bars	100-K	1	100-KWT
	Three-Phase Compact Bus Bars <ul style="list-style-type: none"> <li>Max. current 34 A</li> </ul>		For 100SK, 5...12 A contactors 45 mm spacing (3 connections) <sup>(2)</sup>	100-K	1	100-KW453
			For 100-K, 5...12 A contactors 45 mm spacing (4 connections) <sup>(2)</sup>	100-K	1	100-KW454

(1) May be ordered in package quantities of 10. Add letter M to the end of the cat. no. Example: 140M-C-PEK12M.

(2) Combinations possible. Example: For 6 contactor connections use one cat. no. 100-KW453 and one cat. no. 100-KW454.

**Marking Systems**

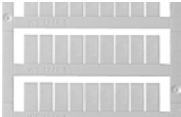
	Description	Pkg. Qty.	Cat. No.
	Label Sheet • 105 self-adhesive paper labels each, 6 x 17 mm	10	100-FMS
	Snap-In Marker Card	5	1492-M6X12

# Specifications

			100-KR		100/104-K			
			05	09	05	09	12	
<b>AC-1 Active Power Load (50 Hz); Ambient temperature 40 °C</b>								
Rated Operational Current, $I_e$	≤500V	[A]	10	10	20	20	20	
	690V	[A]	10	10	20	20	20	
	230V	[kW]	4	4	8	8	8	
	240V	[kW]	4	4	8.3	8.3	8.3	
	400V	[kW]	6.9	6.9	14	14	14	
	415V	[kW]	7	7	14	14	14	
	500V	[kW]	8.7	8.7	17	17	17	
	690V	[kW]	12	12	24	24	24	
	<b>AC-1 Active Power Load (50 Hz); Ambient temperature 60 °C</b>							
Rated Operational Current, $I_e$	≤500V	[A]	10	10	16	16	16	
	690V	[A]	10	10	16	16	16	
	230V	[kW]	4	4	6.4	6.4	6.4	
	240V	[kW]	4	4	6.7	6.7	6.7	
	400V	[kW]	6.9	6.9	11	11	11	
	415V	[kW]	7	7	12	12	12	
	500V	[kW]	8.7	8.7	14	14	14	
	690V	[kW]	12	12	19	19	19	
	<b>Switching of 3-phase Motors; (50 Hz) Ambient temperature 60 °C, AC-2, AC-3</b>							
Rated Operational Current, $I_e$	230V	[A]	6.3	8.5	6.3	11.3	11.3	
	240V	[A]	6.3	8.5	6.3	11.3	11.3	
	400V	[A]	4.9	8.5	4.9	8.5	11.5	
	415V	[A]	4.9	8.5	4.9	8.5	11.5	
	500V	[A]	3.9	6.8	3.9	6.8	9.2	
	690V	[A]	2.8	4.9	2.8	4.9	6.7	
	230V	[kW]	1.5	2.2	1.5	3	3	
	240V	[kW]	1.5	2.2	1.5	3	3	
	400V	[kW]	2.2	4	2.2	4	5.5	
	415V	[kW]	2.2	4	2.2	4	5.5	
	500V	[kW]	2.2	4	2.2	4	5.5	
	690V	[kW]	2.2	4	2.2	4	5.5	
	<b>Load Carrying Capacity per UL/CSA</b>							
	General Purpose Current (enclosed)		[A]	9	9	12	15	18
	Rated power (enclosed) 1-phase	115V	[A]	7.2	7.2	9.8	9.8	13.8
230V		[A]	6.9	8	8	10	12	
115V		[Hp]	1/3	1/3	0.5	0.5	0.75	
230V		[Hp]	3/4	1	1	1.5	2	
Rated power (enclosed) 3-phase	200V	[A]	6.9	7.8	6.9	7.8	11	
	230V	[A]	6	6.8	6	6.8	9.6	
	460V	[A]	4.8	7.6	4.8	7.6	11	
	575V	[A]	3.9	6.1	3.9	6.1	9	
	200V	[Hp]	1.5	2	1.5	2	3	
	230V	[Hp]	1.5	2	1.5	2	3	
	460V	[Hp]	3	5	3	5	7.5	
	575V	[Hp]	3	5	3	5	7.5	

100/104-K		05	09	12	
<b>Switching of 3-phase Motors, (50 Hz); Ambient temperature 60 °C, AC-4</b>					
	230V	[A]	6.3	11.3	11.3
	240V	[A]	6.3	11.3	11.3
	400V	[A]	4.9	8.5	11.5
	415V	[A]	4.9	8.5	11.5
	500V	[A]	3.9	6.8	9.2
	690V	[A]	2.8	4.9	6.7
	230V	[Hp]	1.5	3	3
	240V	[Hp]	1.5	3	3
	400V	[Hp]	2.2	4	5.5
	415V	[Hp]	2.2	4	5.5
	500V	[Hp]	2.2	4	5.5
	690V	[Hp]	2.2	4	5.5
<b>AC-4 at approximately 200,000 operations</b>					
	230V	[A]	2.3	3.9	3.9
	240V	[A]	2.3	3.9	3.9
	400/415V	[A]	2	3.6	3.6
	500V	[A]	1.9	3.2	3.2
	230V <sup>(1)</sup>	[Hp]	0.37	0.75	0.75
	240V <sup>(1)</sup>	[Hp]	0.37	0.75	0.75
	400V <sup>(1)</sup>	[Hp]	0.75	1.5	1.5
	415V <sup>(1)</sup>	[Hp]	0.75	1.5	1.5
	500V <sup>(1)</sup>	[Hp]	0.75	1.5	1.5
	Max. switching frequency		Ops/hour	250	250
<b>Wye-Delta (60 Hz)</b>					
	200V	[Hp]	2.2	3	5
	230V	[Hp]	2.2	3	5
	460V	[Hp]	5	7.5	10
	575V	[Hp]	5	7.5	10
<b>Star-Delta Starting (50 Hz)</b>					
	≤ 230V	[A]	11.3	20	20
	≤ 240V	[A]	11.3	20	20
	400V	[A]	8.5	15.5	15.5
	415V	[A]	8.5	15.5	15.5
	500V	[A]	6.8	12.4	12.4
	690V	[A]	4.9	8.9	8.9
	230V <sup>(1)</sup>	[kW]	3	5.5	5.5
	240V <sup>(1)</sup>	[kW]	3	5.5	5.5
	400V <sup>(1)</sup>	[kW]	4	7.5	7.5
	415V <sup>(1)</sup>	[kW]	4	7.5	7.5
	500V <sup>(1)</sup>	[kW]	4	7.5	7.5
	690V <sup>(1)</sup>	[kW]	4	7.5	7.5

(1) Power ratings at 50 Hz: Preferred values according to IEC 60072-1

100/104-K			05	09	12
<b>Switching of Power Transformers, AC-6a (50 Hz)</b>					
Inrush Current		=n			
Rated transformer current					
n= 30	≤ 230V	[A]	2.9	5.4	5.4
	≤ 240V	[A]	2.9	5.4	5.4
	≤ 400V	[A]	2.4	4.1	5.4
	≤ 415V	[A]	2.4	4.1	5.4
	≤ 500V	[A]	1.8	3.2	3.2
	230V	[kVA]	1.2	2	2
	240V	[kVA]	1.2	2	2
	400V	[kVA]	1.7	2.8	3.4
	415V	[kVA]	1.7	2.8	3.4
	500V	[kVA]	1.7	2.8	3.4
690V	[kVA]	2	4	5	
<b>Switching of Lamps</b>					
Gas discharge lamps AC-5a, 40 °C					
open		[A]	18	18	18
enclosed		[A]	14.5	14.5	14.5
Individually compensated:					
Max. capacitance at expected					
Short-circuit current of	10 kA	[μF]	750	750	750
	20 kA	[μF]	400	400	400
Filament AC-5b	230/240V	[A]	5	9	9
<b>Switching of Low Inductive Loads in Home Appliances and Similar Applications per IEC 61095 (50 Hz)</b>					
AC-7a	230V	[A]	20	20	20
	400V	[A]	20	20	20
<b>Switching of Motor Load for Home Appliances (50 Hz)</b>					
AC-7b	230V	[A]	6	11	11
	400V	[A]	6	11	11
<b>Switching of Hermetically Sealed Cooling Compressor Motors - manual reset of overload release (50 Hz)</b>					
AC-8a	400V	[A]	11	18	18
	500V	[A]	10	15	15
<b>Switching of DC Loads</b>					
Non-inductive or slightly inductive loads or resistance furnaces DC-1, 60 °C					
1 pole	24V	[A]	6	9	9
	48/60V	[A]	4/1	6/1.5	6/1.5
	110V	[A]	0.6	1	1
	220V	[A]	0.2	0.3	0.3
	440V	[A]	0.08	0.1	0.1
2 poles in series	24V	[A]	6	9	9
	48/60V	[A]	6	8	8
	110V	[A]	4	6	6
	220V	[A]	0.8	1.2	1.2
3 poles in series	24V	[A]	6	9	9
	48/60V	[A]	6	9	9
	110V	[A]	6	9	9
	220V	[A]	3	4	4
3 poles in series	24V	[A]	6	9	9
	48/60V	[A]	6	9	9
	110V	[A]	6	9	9
	220V	[A]	3	4	4

100/104-K			05	09	12
<b>Shunt-wound Motors</b>					
<b>Starting, reverse current braking, reversing, stepping DC-3, 60 °C</b>					
3 poles in series	24V	[A]	5	9	9
	48/60V	[A]	4	6	6
	110V	[A]	2	3	3
	220V	[A]	0.8	1.2	1.2
440V	[A]	0.15	0.2	0.2	
<b>Series-wound Motors</b>					
<b>Starting, reverse current braking, reversing, stepping DC-5, 60 °C</b>					
3 poles in series	24V	[A]	5	9	9
	48/60V	[A]	2	3	3
	110V	[A]	0.6	1	1
	220V	[A]	0.1	0.1	0.1
Short Time Withstand $I_{CW}$ , 60 °C	10 s	[A]	60	96	96
<b>Resistance and Power Dissipation</b>					
Main current circuit resistance		[mΩ]	2.2	2.2	2.2
Power dissipation by all circuits at $I_e$ AC-3/400V		[W]	0.3	0.9	0.9
<b>Total power dissipation</b>					
At $I_e$ AC-3/400V	AC control	[W]	2.1	2.7	2.7
	DC control (electronic)	[W]	2.9	3.5	3.5
<b>Lifespan</b>					
Mechanical AC control	[Mil. operations]		15	15	15
Mechanical DC control	[Mil. operations]		15	15	15
Electrical AC-3 (400 V)	[Mil. operations]		0.7	0.7	0.7
<b>Weight</b>					
AC	Non-Rev.	kg (lbs.)	0.16 (0.35)		
	Rev.	kg (lbs.)	0.4 (0.88)		
DC	Non-Rev.	kg (lbs.)	0.2 (0.44)		
	Rev.	kg (lbs.)	0.48 (1.06)		

	100-KR		100/104-K		
	05	09	05	09	12
Conductor Cross Sections - Main Contacts Terminal type					
	1 conductor	[mm <sup>2</sup> ]	0.50...2.5		0.75...2.5
	2 conductors	[mm <sup>2</sup> ]	0.50...2.5		0.75...2.5
	1 conductor	[mm <sup>2</sup> ]	0.75...2.5 <sup>(2)</sup>		1...4
	2 conductors	[mm <sup>2</sup> ]	0.75...2.5 <sup>(2)</sup>		1...2.5+1...4
Recommended torque	[N·m]	—		1.2	
Cross section per UL/CSA	[AWG]	18...14 <sup>(2)</sup>		18...12	
Recommended torque	[lb-in]	—		10.6	

(1) Pozidriv No. 2 / Blade No. 3 screw  
 (2) Fine- or coarse-stranded only

### Short-Circuit Coordination Data

See <https://www.rockwellautomation.com/global/support/global-sccr.page> for complete short-circuit current ratings.



100/104-K		05	09	12
<b>Short Circuit Coordination (Max. Fuse or Circuit Breaker Rating) Per IEC 60947-4-1 (contactor and fuses only)</b>				
DIN Fuses- gG, gL		50 kA Available Fault Current		
Type "1"(690V)	[A]	35	35	35
Type "2"(400V)	[A]	16	20	20
<b>Per UL 508 and CSA 22.2 No. 14 (contactor and fuses or circuit breaker only)</b>				
<b>UL Class K5 and RK5 Fuses</b>		5 kA Available Fault Current		
UL Listed Combination (600V)	[A]	40	40	40
<b>UL Class CC and CSA HRCI-MISC Fuses</b>				
UL Listed Combination (600V)	[A]	30	30	30
<b>UL Class J and CSA HRCI-J Fuses</b>		50 kA Available Fault Current		
UL Listed Combination (600V)	[A]	30	30	30

### Coil Data

100/104-K		05	09	12
<b>Operating Limits</b>				
50 Hz, 60 Hz, 50/60 Hz	pick-up	[x U <sub>s</sub> ]	0.85...1.1	
	dropout	[x U <sub>s</sub> ]	0.2...0.75	
DC (conventional)	pick-up	[x U <sub>s</sub> ]	0.8...1.1 0.7...1.25 <sup>(1)</sup>	
	dropout	[x U <sub>s</sub> ]	0.1...0.75	
<b>Coil Consumption</b>				
50 Hz, 60 Hz, 50/60 Hz	pick-up	[VA]	35	
	hold-in	[VA/W]	5/1.8	
DC (conventional)	pick-up	[W]	cold 3.0, warm 2.6	
	hold-in	[W]	cold 3.0, warm 2.6	
<b>Operating Times</b>				
AC	closing delay	[ms]	15...40	
	opening delay	[ms]	15...33	
With RC module	closing delay	[ms]	15...28	
	opening delay	[ms]	18...40	
DC (conventional)	closing delay	[ms]	6...12	
	opening delay	[ms]	8...12	
With integrated diode	opening delay	[ms]	8...12	
	opening delay	[ms]	35...50	

(1) For 9, 12, 24, and 110V DC coils

### Auxiliary Contacts and Auxiliary Contact Blocks

Conventional Coils		Internal	Front mounted	
<b>Switching of AC Loads</b>				
AC-12 I <sub>th</sub>	at 40 °C	[A]	10	10
	at 60 °C	[A]	6	6
AC-15 at rated voltage of	24V	[A]	6	3
	42/48V	[A]	6	3
	120V	[A]	6	3
	230V	[A]	3	2
	240V	[A]	3	2
	400V	[A]	1.8	1.2
	415V	[A]	1.8	1.2
	500V	[A]	1.4	1.0
690V	[A]	1.0	0.6	
<b>Switching of DC Loads</b>				
DC-12 L/R < 1 ms resistive loads at	24V DC	[A]	6	—
	48V DC	[A]	4	—
	110V DC	[A]	0.6	—
	220V DC	[A]	0.2	—
	440V DC	[A]	0.08	—
DC-14L/R < 15 ms inductive loads with economy resistor in series at	24V DC	[A]	4	—
	48V DC	[A]	2.5	—
	110V DC	[A]	0.4	—
	220V DC	[A]	0.12	—
	440V DC	[A]	0.05	—
DC-13 switching electromagnets at	24V DC	[A]	2.8	2.3
	48V DC	[A]	1.2	1
	110V DC	[A]	0.55	0.55
	220V DC	[A]	0.27	0.27
	440V DC	[A]	0.15	0.15
Fuse gG		[A]	10	10
		[A]	10	10
Min. switching capacity according to IEC 60947-5-4			15V/ 10 mA	15V/ 2 mA
<b>Load Carrying Capacity per UL/CSA</b>				
Rated voltage	AC	[V]	max.600	
Continuous rating	40 °C	[A]	10	
Switching capacity	AC	[A]	A600	B600
Rated voltage	DC	[V]	max.600	
Switching capacity	DC	[A]	Q600	

## General

Attribute		Value
<b>Rated Isolation Voltage <math>U_i</math></b>		
IEC	[V]	690
UL_CSA	[V]	600
Rated Impulse Voltage Withstand $U_{imp}$	[kV]	6
<b>Rated Voltage <math>U_e</math></b>		
AC 50/60 Hz	[V]	230, 240, 400, 415, 460, 500, 575, 690
DC	[V]	24, 48, 110, 220, 440
Insulation Class of the Coil		Class F per IEC 60085 Class 105 insulation system per UL 508
Rated coil frequency		AC 50/60 Hz, DC
Ambient Temperature		
Storage	[°C]	-55...+80
Operation at rated voltage	[°C]	-25...+60
at 70 °C		15% current reduction against 60 °C values
Climatic Withstand		IEC60068-2-30
Max. Altitude of Installation Site	[m]	2000 NN, per IEC60947-4
Protection Class		IP2X
Single contactor cover		—
Contactor with frame terminal block		—
Auxiliary contact		IP2X
Protection against Accidental Contact		—
Resistance to Shock		IEC60068-2
Resistance to Vibration		IEC60068-2
Mechanically Linked Contacts IEC60947-5-1,AnnexL		100-K... (on main device)
Mirror Contacts IEC60947-4 Annex F		100-K... +100-KF...

## Standards Compliance and Certifications

Standards Compliance	Certifications
IEC/EN 60947-1,-4-1,-5-1,-5-4	CE Marked
UL 508	CCC
CSA 22.2. No. 14	cULus Listed (File No. E41850, Guide NLDX, NLDX7)
NF F 62-000	
Meets the material restrictions for European Directive 2002/95/IEC-EU-RoHS	



# Life-Load Curves

Figure 1 - AC-3, Switching of squirrel-cage motors while starting /AC-1, Non- or slightly inductive loads, resistance furnaces

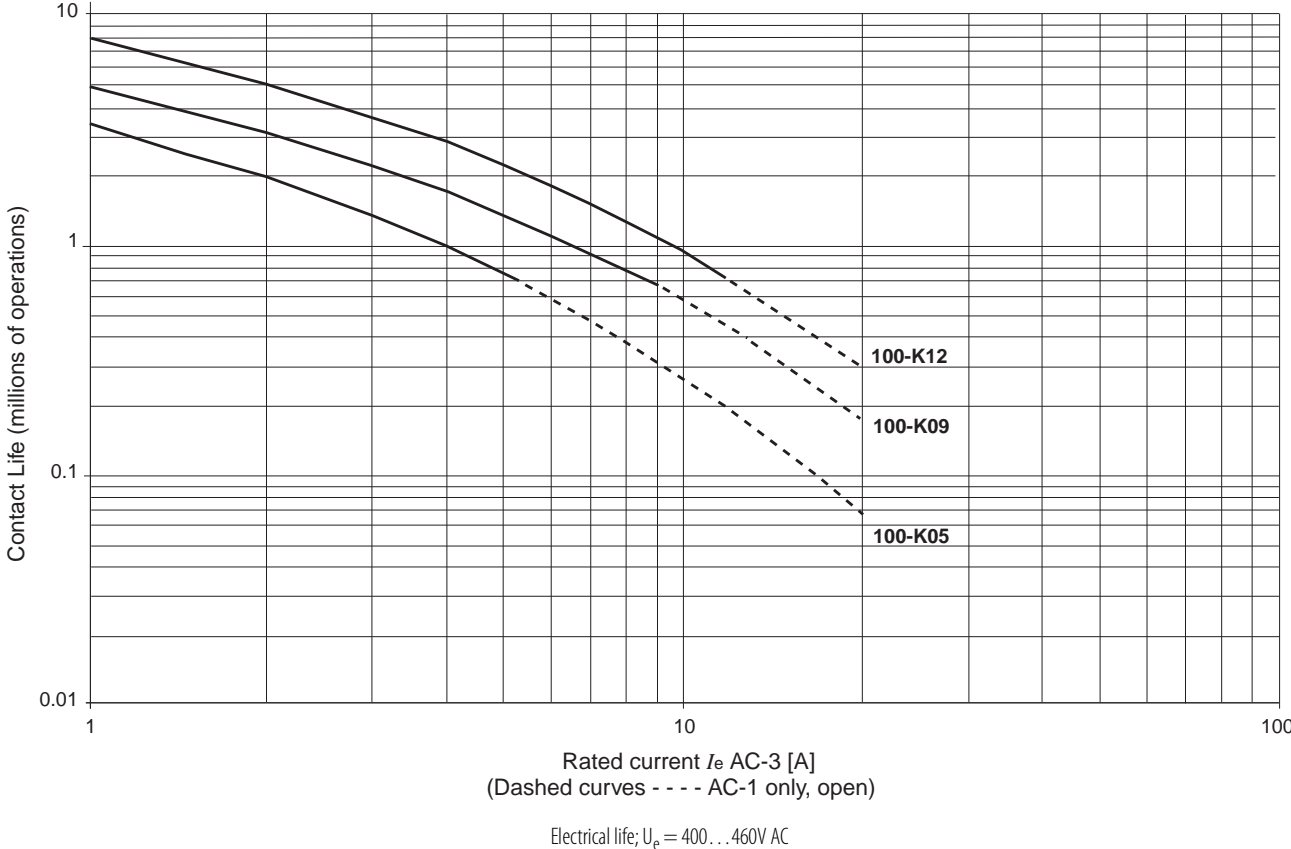
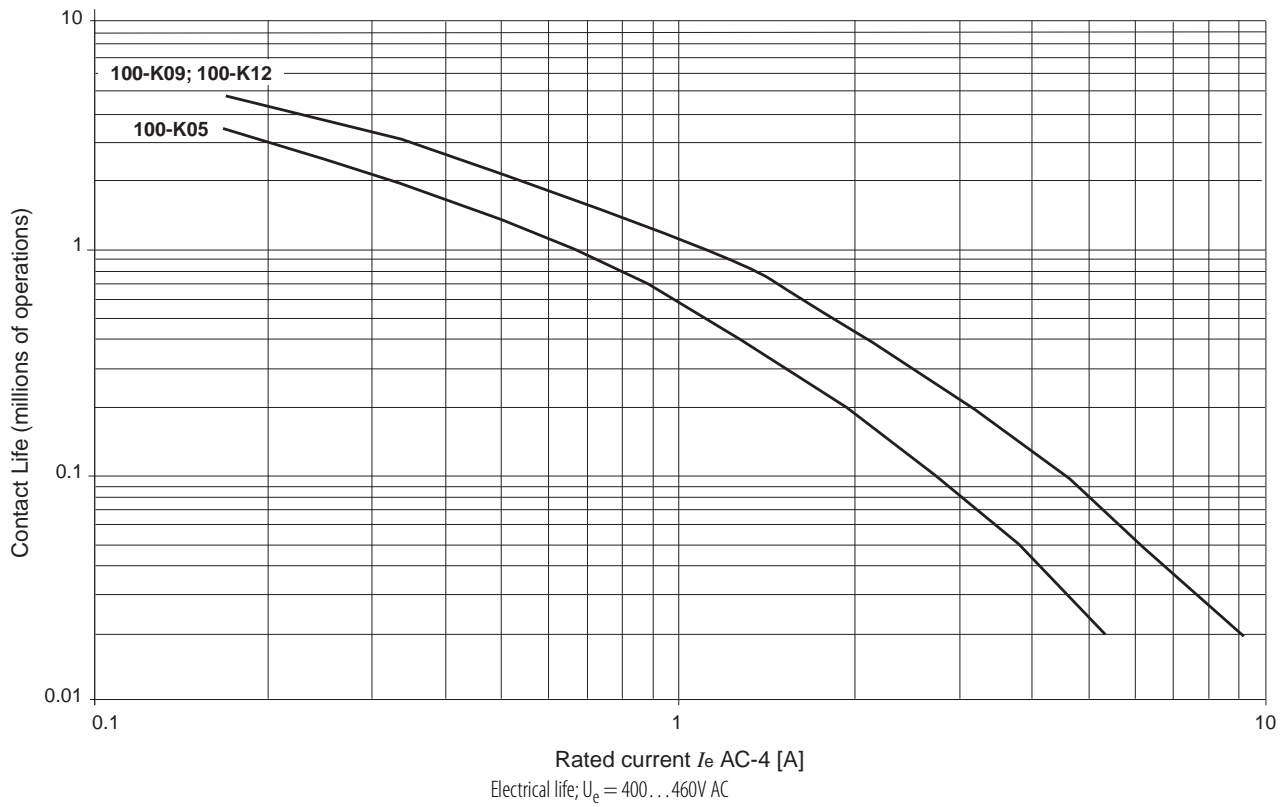

Figure 2 - AC-4, Stepping of squirrel-cage motors



# Approximate Dimensions

Dimensions are shown in millimeters (inches). Dimensions are not intended for manufacturing purposes.

Figure 3 - 100-K Miniature Contactor with 193-K Overload Relay

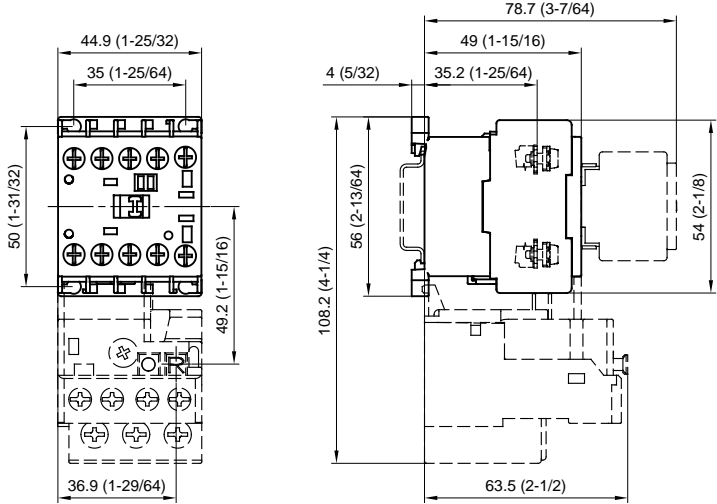
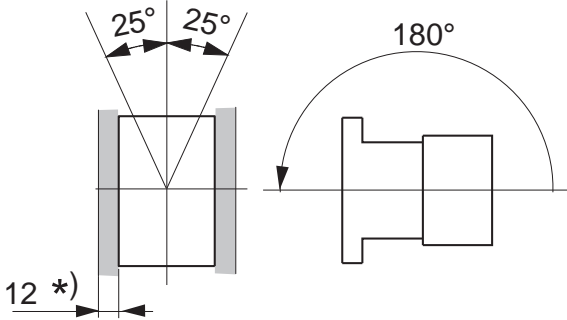

Figure 4 - Mounting Position



\*) -Minimum distance to grounded parts or walls

Notes:

# 100-C/104-C, 100S-C/104S-C, 100Q-C Contactors

## Product Selection—100-C/104-C Contactors

- Compact sizes from 4...55 kW/5...75 Hp (9...97 A)
- Common accessories for all contactor sizes
- Front and side mounting of auxiliary contacts
- Electronic and pneumatic timing modules
- Space-saving coil-mounted control modules
- Reversible coil terminations (line or load side)
- All devices can be attached to 35 mm DIN mounting Rail
- Environmentally friendly materials



100-C Contactor



104-C Reversing Contactor

The Bulletin 100-C/104-C IEC contactor family, along with a wide range of common accessories and Bulletin 193 solid-state overload relays, provides the most compact and flexible starter component system available.



### 3-Pole AC- and DC-operated Contactors

Rated Operational Current $I_e$ [A]		Ratings for switching AC motors - AC-2, AC-3, AC-4										Auxiliary Contacts		Cat. No. <sup>(1)</sup>
		3-phase kW (50 Hz)				Hp (60 Hz)						N.O.	N.C.	
		40 °C		230V	400/415V	500V	690V	1-Phase		3-Phase				
AC-3	AC-1	115V	230V					200V	230V	460V	575V			
9	32	3	4	4	4	1/2	1-1/2	2	2	5	7-1/2	1	0	100-C09⊗10
												0	1	100-C09⊗01
12	32	4	5.5	5.5	5.5	1/2	2	3	3	7-1/2	10	1	0	100-C12⊗10
												0	1	100-C12⊗01
16	32	5.5	7.5	7.5	7.5	1	3	5	5	10	15	1	0	100-C16⊗10
												0	1	100-C16⊗01
23	32	7.5	11	13	10	2	3	5	7-1/2	15	15	1	0	100-C23⊗10
												0	1	100-C23⊗01
30	65	10	15	15	15	2	5	7-1/2	10	20	25	0	0	100-C30⊗00
												1	0	100-C30⊗10
												0	1	100-C30⊗01
37	65	11	18.5/20	20	18.5	3	5	10	10	25	30	0	0	100-C37⊗00
												1	0	100-C37⊗10
												0	1	100-C37⊗01
43	85	13	22	25	22	3	7-1/2	10	15	30	30	0	0	100-C43⊗00
												1	0	100-C43⊗10
												0	1	100-C43⊗01
55	85	15	30	30	30	5	10	15	20	40	40	0	0	100-C55⊗00
												1	0	100-C55⊗10
												0	1	100-C55⊗01
60	100	18.5	32	37	32	5	10	15	20	40	50	0	0	100-C60⊗00
												1	0	100-C60⊗10
												0	1	100-C60⊗01
72	100	22	40	45	40	5	15	20	25	50	60	0	0	100-C72⊗00
												1	0	100-C72⊗10
												0	1	100-C72⊗01
85	100	25	45	55	45	7-1/2	15	25	30	60	60	0	0	100-C85⊗00
												1	0	100-C85⊗10
												0	1	100-C85⊗01
97	130	30	55	55	55	10	20	30	30	75	75	0	0	100-C97⊗00
												1	0	100-C97⊗10
												0	1	100-C97⊗01

(1) For screwless terminals on 100-C09...C16, add an "R" after the letter "C" in the catalog number. Example: Cat. No. 100-C09⊗10 becomes 100-CR09⊗10. The AC-1 rating for the 100-CR is limited to 25 A.

⊗ Coil voltage code and terminal position—see [page 24](#)



## 4-Pole AC- and DC-Operated Contactors

Rated Operational Current $I_e$ [A]		Ratings for switching AC motors - AC-2, AC-3										Contact Configuration, Main Poles		Cat. No. <sup>(1)</sup>
		3-phase kW (50 Hz) <sup>(2)</sup>				Hp (60 Hz)								
		40 °C		230V	400/415V	500V	690V	1-Phase		3-Phase*				
AC-3	AC-1	115V	230V					200V	230V	460V	575V	N.O.	N.C.	
9	32	3	4	4	4	1/2	1-1/2	2	2	5	7-1/2	4	0	100-C09⊗400
												3	1	100-C09⊗300
												2	2	100-C09⊗200
12	32	4	5.5	5.5	5.5	1/2	2	3	3	7-1/2	10	4	0	100-C12⊗400
												3	1	100-C12⊗300
												2	2	100-C12⊗200
16	32	5.5	7.5	7.5	7.5	1	3	5	5	10	10	4	0	100-C16⊗400
												3	1	100-C16⊗300
												2	2	100-C16⊗200
23	32	7.5	11	13	10	2	3	5	7-1/2	15	15	4	0	100-C23⊗400
												3	1	100-C23⊗300
												2	2	100-C23⊗200
37	75	11	18.5/20	20	18.5	3	5	10	10	25	30	4	0	100-C40⊗400
												2	2	100-C40⊗200
85	130	25	45	55	45	7-1/2	15	25	30	60	50	4	0	100-C90⊗400
												2	2	100-C90⊗200

(1) For screwless terminals on 100-C09...C16, add an "R" after the letter "C" in the catalog number. Example: Cat. No. 100-C09⊗10 becomes 100-CR09⊗10. The AC-1 rating for the 100-CR is limited to 25 A.  
 (2) Three-phase ratings apply only to contactors with at least three N.O. power poles.

⊗ Coil voltage code and terminal position— see [page 24](#).

## Reversing AC- and DC-Operated Contactors

Rated Operational Current $I_e$ [A]		Ratings for switching AC motors - AC-2, AC-3, AC-4										Auxiliary Contacts per Contactor		Cat. No.
		3-phase kW (50 Hz)				Hp (60 Hz)								
		40 °C		230V	400/415V	500V	690V	1-Phase		3-Phase				
AC-3	AC-1	115V	230V					200V	230V	460V	575V	N.O.	N.C. <sup>(1)</sup>	
9	32	3	4	4	4	1/2	1-1/2	2	2	5	7-1/2	1	1	104-C09⊗22
12	32	4	5.5	5.5	5.5	1	2	3	3	7-1/2	10	1	1	104-C12⊗22
16	32	5.5	7.5	7.5	7.5	1	3	5	5	10	15	1	1	104-C16⊗22
23	32	7.5	11	13	10	2	3	5	7-1/2	15	20	1	1	104-C23⊗22
30	65	10	15	15	15	2	5	7-1/2	10	20	25	0	1	104-C30⊗02
												1	1	104-C30⊗22
37	65	11	18.5/20	20	18.5	3	5	10	10	25	30	0	1	104-C37⊗02
												1	1	104-C37⊗22
43	85	13	22	25	22	3	7.5	10	15	30	30	0	1	104-C43⊗02
												1	1	104-C43⊗22
55	85	15	30	30	30	5	10	15	20	40	40	0	1	104-C55⊗02
												1	1	104-C55⊗22
60	100	18.5	32	37	32	5	10	15	20	40	50	0	1	104-C60⊗02
												1	1	104-C60⊗22
72	100	22	40	45	40	5	15	20	25	50	60	0	1	104-C72⊗02
												1	1	104-C72⊗22
85	100	25	45	55	45	7-1/2	15	25	30	60	60	0	1	104-C85⊗02
												1	1	104-C85⊗22
97	130	30	55	55	55	10	15	30	30	75	75	0	1	104-C97⊗02
												1	1	104-C97⊗22

(1) The N.C. auxiliary contact is supplied as part of the mechanical/electrical interlock.

⊗ Coil voltage code and terminal position — see [page 24](#).

## Coil Voltage Codes

The Cat. No. as listed is incomplete. Select a coil voltage code from the table below to complete the Cat. No. Example: 120V, 60 Hz: Cat. No. 100-C09⊗10 becomes Cat. No.100-C09D10.

AC Voltages [V]	12	24	32	36	42	48	100	100... 110	110	120	127	200	200... 220	208	208... 240
50 Hz	R	K	V	W	X	Y	KP	—	D	P	S	KG	L	—	—
60 Hz	Q	J	—	V	—	X	—	KP	—	D	—	—	KG	H	L
50/60 Hz	—	KJ	—	—	—	KY	KP	—	KD	—	—	KG	KL <sup>(1)</sup>	—	—

(1) Not available on 100/104-C90 or -C97 contactors.

AC Voltages [V]	220... 230	230	230... 240	240	277	347	380	380... 400	400	400... 415	440	480	500	550	600
50 Hz	F	—	VA	T	—	—	—	N	—	G	B	—	M	C	—
60 Hz	—	—	—	A	T	I	E	—	—	—	N	B	—	—	C
50/60 Hz	KL <sup>(1)</sup>	KF	—	KA	—	—	—	—	KN	—	KB	—	—	—	—

(1) Not available on 100/104-C90 or -C97 contactors.

DC Voltages [V]		9	12	24	24	36	36...48	48	48...72	60	64
100-C09...C55	Electronic with Integrated Diode	—	EQ	EJ	QJ <sup>(1)</sup>	—	EW	—	EY	—	—
100-C60...C97	with Integrated Diode	DR	DQ	DJ	—	DW	—	DY	—	DZ	DB

(1) "QJ" coil has faster dropout time (16...21 ms).

DC Voltages [V]		72	80	110	110...125	115	125	220	220...250	230	250
100-C09...C55	Electronic with Integrated Diode	—	—	—	ED	—	—	—	EA	—	—
100-C60...C97	with Integrated Diode	DG	DE	DD	—	DP	DS	DA	—	DF	DT

## Coil Terminal Position

All contactors are delivered with the coil terminals located on the line side.

For load side coil terminations, insert a "U" prior to the coil voltage code. Ordering example: Cat. No. 100-C09UD10.



Cat. No.100-C09⊗10 Line Side

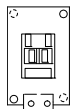

Cat. No.100-C09U⊗10 Load Side



## Assignment of Contacts

Table valid for: AC / DC = 0.85...1.1 x U<sub>s</sub>, T<sub>amb</sub> = -25 °C...+60 °C, normal position (horizontal rail mounting)

### Device Combinations in Accordance with IEC 60947-1 / -4-1

Auxiliary Contact Blocks		100-C Contactors (AC and DC Control)						
Circuit Diagram	Control	100-C09_⊗10	100-C09_⊗01	100-C30_⊗00 100-C37_⊗00 100-C43_⊗00 100-C55_⊗00 100-C60_⊗00 100-C72_⊗00 100-C85_⊗00 100-C97_⊗00	100-C09_⊗400 100-C12_⊗400 100-C16_⊗400 100-C23_⊗400 100-C40_⊗400 100-C90_⊗400	100-C09_⊗300 100-C12_⊗300 100-C16_⊗300 100-C23_⊗300	100-C09_⊗200 100-C12_⊗200 100-C16_⊗200 100-C23_⊗200 100-C40_⊗200 100-C90_⊗200	
Side Mounting <sup>(1)</sup>								
100-SB01		AC/DC	10 + 01 = 11	01 + 01 = 02 <sup>(3)</sup>	00 + 01 = 01	00 + 01 = 01	00 + 01 = 01	00 + 01 = 01
100-SB10		AC/DC	10 + 10 = 20 <sup>(3)</sup>	01 + 10 = 11	00 + 10 = 10	00 + 10 = 10	00 + 10 = 10	00 + 10 = 10
100-SB02		AC/DC	10 + 02 = 12 <sup>(3)</sup>	—	00 + 02 = 02	00 + 02 = 02	00 + 02 = 02	00 + 02 = 02
100-SB11		AC/DC	10 + 11 = 21 <sup>(3)</sup>	01 + 11 = 12 <sup>(3)</sup>	00 + 11 = 11	00 + 11 = 11	00 + 11 = 11	00 + 11 = 11
100-SB20		AC/DC	10 + 20 = 30 <sup>(3)</sup>	01 + 20 = 21 <sup>(3)</sup>	00 + 20 = 20	00 + 20 = 20	00 + 20 = 20	00 + 20 = 20
100-SBL11 <sup>(2)</sup>		AC/DC	10 + L11 = L21 <sup>(3)</sup>	01 + L11 = L12 <sup>(3)</sup>	00 + L11 = L11	00 + L11 = L11	00 + L11 = L11	00 + L11 = L11

(1) Up to 8 auxiliary contacts possible: contactor + front mounted (AC max. 4 N.C. / DC max. 4 N.C.), side mounted (AC max. 2 N.O. / DC max. 2 N.O. and max. 2 N.C.).

(2) Early make and/or late break.

(3) Double numbering: because of double numbering only left-side mounting is recommended.

Device Combinations in Accordance with IEC 60947-1 / -4-1

Auxiliary Contact Blocks		100-C Contactors (AC and DC Control)						
Circuit Diagram	Control	100-C09_⊗10	100-C09_⊗01	100-C30_⊗00 100-C37_⊗00 100-C43_⊗00 100-C55_⊗00	100-C09_⊗400 100-C12_⊗400	100-C09_⊗300 100-C12_⊗300	100-C09_⊗200 100-C12_⊗200	
		100-C16_⊗10 100-C23_⊗10	100-C16_⊗01 100-C23_⊗01	100-C60_⊗00 100-C72_⊗00 100-C85_⊗00 100-C97_⊗00	100-C16_⊗400 100-C23_⊗400 100-C40_⊗400 100-C90_⊗400	100-C16_⊗300 100-C23_⊗300	100-C16_⊗200 100-C23_⊗200 100-C40_⊗200 100-C90_⊗200	
Front Mounting <sup>(1)</sup>								
100-FA02, 100-FAB02		AC/DC	10 + 02 = 12	01 + 02 = 03	00 + 02 = 02	00 + 02 = 02	00 + 02 = 02	00 + 02 = 02
100-FA11, 100-FAB11		AC/DC	10 + 11 = 21	01 + 11 = 12	00 + 11 = 11	00 + 11 = 11	00 + 11 = 11	00 + 11 = 11
100-FB11, 100-FBB11		AC/DC	—	—	00 + 11 = 11	00 + 11 = 11	00 + 11 = 11	00 + 11 = 11
100-FC11, 100-FCB11		AC/DC	10 + 11 = 21	—	—	—	—	—
100-FA20, 100-FAB20		AC/DC	10 + 20 = 30	01 + 20 = 21	00 + 20 = 20	00 + 20 = 20	00 + 20 = 20	00 + 20 = 20
100-FBL11 <sup>(2)</sup>		AC/DC	—	—	00 + L11 = L11	00 + L11 = L11	00 + L11 = L11	00 + L11 = L11
100-FA22, 100-FAB22		AC/DC	10 + 22 = 32	01 + 22 = 23	00 + 22 = 22	00 + 22 = 22	00 + 22 = 22	00 + 22 = 22
100-FB22, 100-FBB22		AC/DC	—	—	00 + 22 = 22	00 + 22 = 22	00 + 22 = 22	00 + 22 = 22
100-FC22, 100-FCB22		AC/DC	10 + 22 = 32	—	—	—	—	—
100-FA31, 100-FAB31		AC/DC	10 + 31 = 41	01 + 31 = 32	00 + 31 = 31	00 + 31 = 31	00 + 31 = 31	00 + 31 = 31
100-FA40, 100-FAB40		AC/DC	10 + 40 = 50	01 + 40 = 41	00 + 40 = 40	00 + 40 = 40	00 + 40 = 40	00 + 40 = 40
100-FAL22 <sup>(2)</sup>		AC/DC	10 + L22 = L32	01 + L22 = L23	00 + L22 = L22	00 + L22 = L22	00 + L22 = L22	00 + L22 = L22
100-FA04, 100-FAB04		AC/DC	10 + 04 = 14	01 + 04 = 05	00 + 04 = 04	00 + 04 = 04	00 + 04 = 04	00 + 04 = 04

Auxiliary Contact Blocks		100-C Contactors (AC and DC Control)						
Circuit Diagram	Control	100-C09_⊗10	100-C09_⊗01	100-C30_⊗00 100-C37_⊗00 100-C43_⊗00 100-C55_⊗00 100-C60_⊗00 100-C72_⊗00 100-C85_⊗00 100-C97_⊗00	100-C09_⊗400 100-C12_⊗400 100-C16_⊗400 100-C23_⊗400 100-C40_⊗400 100-C90_⊗400	100-C09_⊗300 100-C12_⊗300 100-C16_⊗300 100-C23_⊗300	100-C09_⊗200 100-C12_⊗200 100-C16_⊗200 100-C23_⊗200 100-C40_⊗200 100-C90_⊗200	
100-FA13, 100-FAB13		AC/DC	10 + 13 = 23	01 + 13 = 14	00 + 13 = 13	00 + 13 = 13	00 + 13 = 13	00 + 13 = 13
100-FB02, 100-FBB02		AC/DC	10 + 02 = 12	01 + 02 = 03	00 + 02 = 02	00 + 02 = 02	00 + 02 = 02	00 + 02 = 02
100-FB20, 100-FBB20		AC/DC	10 + 20 = 30	01 + 20 = 21	00 + 20 = 20	00 + 20 = 20	00 + 20 = 20	00 + 20 = 20
100-FC31, 100-FCB31		AC/DC	10 + 31 = 41	01 + 31 = 32	00 + 31 = 31	00 + 31 = 31	00 + 31 = 31	00 + 31 = 31

- (1) Up to 8 auxiliary contacts possible: contactor + front mounted (AC max. 4 N.C. / DC max. 4 N.C.), side mounted (AC max. 2 N.O. / DC max. 2 N.O. and max. 2 N.C.).
- (2) Early make and/or late break.

# Product Selection—100S-C/104S-C Safety Contactors

- Mechanically linked N.C. auxiliary contacts
- Front-mounted auxiliary contacts
  - Gold bifurcated
  - Permanently fixed
  - Protective cover to prevent manual operation
  - Red contact housing for easy identification
  - “Mechanically Linked” or “Mirror Contact” symbol
- AC and DC operating coils
- SUVA Third-Party certification





100S-C Safety Contactor



104S-C Reversing Safety Contactor

Bulletin 100S-C/104S-C safety contactors provide mechanically linked positively guided contacts, required in feedback circuits of modern safety applications. The mechanically linked N.C. auxiliary contacts will not change state when a power pole welds. In addition, the gold-plated bifurcated auxiliary contacts are ideally suited for low-energy applications or feedback control circuits with multiple series-connected N.C. auxiliary contacts.









## 3-Pole AC- and DC-operated Contactors

Rated Operational Current $I_e$ [A]		Ratings for switching AC motors - AC-2, AC-3, AC-4										Auxiliary Contacts		Cat. No. <sup>(1) (2)</sup>
		3-phase kW (50 Hz)				Hp (60 Hz)								
40 °C		230V	400/415V	500V	690V	1-Phase		3-Phase						
AC-3	AC-1					115V	230V	200V	230V	460V	575V			
9	32	3	4	4	4	1/2	1-1/2	2	2	5	7-1/2	0	5	100S-C09⊗05BC
						1	4	100S-C09⊗14BC						
12	32	4	5.5	5.5	5.5	1/2	2	3	3	7-1/2	10	0	5	100S-C12⊗05BC
						1	4	100S-C12⊗14BC						
16	32	5.5	7.5	7.5	7.5	1	3	5	5	10	15	0	5	100S-C16⊗05BC
						1	4	100S-C16⊗14BC						
23	32	7.5	11	13	10	2	3	5	7-1/2	15	15	0	5	100S-C23⊗05BC
						1	4	100S-C23⊗14BC						
30	65	10	15	15	15	2	5	7-1/2	10	20	25	0	4	100S-C30⊗04BC
						1	4	100S-C30⊗14BC						
37	65	11	18.5/20	20	18.5	3	5	10	10	25	30	0	4	100S-C37⊗04BC
						1	4	100S-C37⊗14BC						
43	85	13	22	25	22	3	7-1/2	10	15	30	30	0	4	100S-C43⊗04BC
						1	4	100S-C43⊗14BC						
55	85	15	30	30	30	5	10	15	20	40	40	0	4	100S-C55⊗04BC
						1	4	100S-C55⊗14BC						
60	100	18.5	32	37	32	5	10	15	20	40	50	0	4	100S-C60⊗04BC <sup>(3)</sup>
						1	4	100S-C60⊗14BC <sup>(3)</sup>						
72	100	22	40	45	40	5	15	20	25	50	60	0	4	100S-C72⊗04BC <sup>(3)</sup>
						1	4	100S-C72⊗14BC <sup>(3)</sup>						
85	100	25	45	55	45	7-1/2	15	25	30	60	60	0	4	100S-C85⊗04BC <sup>(3)</sup>
						1	4	100S-C85⊗14BC <sup>(3)</sup>						
97	130	30	55	55	55	10	15	30	30	75	75	0	4	100S-C97⊗04BC <sup>(3)</sup>
						1	4	100S-C97⊗14BC <sup>(3)</sup>						

(1) For other contact configurations and full product details, please contact your local Rockwell Automation sales office or Allen-Bradley distributor.  
 (2) If standard cross-stamped front-mount auxiliary contacts are required, remove the letter "B" before the letter "C" in the cat. no. Example: Cat. No. 100S-C09⊗05BC becomes Cat. No. 100S-C09⊗05C.  
 (3) Front- and side-mount auxiliary contacts on Cat. Nos. 100S-C60...C97 conform to mirror contact performance only.

⊗ Coil voltage code and terminal position— see [page 31](#).

## 4-Pole AC- and DC-operated Contactors

$I_e$ [A]		Ratings for Switching AC Motors										Contact Configuration				Cat. No. <sup>(1) (2)</sup>
		AC-2, AC-3, AC-4					Hp (60 Hz)					Main Pole		Auxiliary Contacts		
		3-Phase kW (50 Hz) <sup>(3)</sup>					1-Phase		3-Phase <sup>(3)</sup>							
AC-3	AC-1	230V	400V/ 415V	500V	690V	115V	230V	200V	230V	460V	575V					
9	32	3	4	4	4	1/2	1-1/2	2	2	5	7-1/2	N.O.	N.C.	N.O.	N.C.	100S-C09⊗404BC
												3	1	0	4	100S-C09⊗304BC
12	32	4	5.5	5.5	5.5	1/2	2	3	3	7-1/2	10	4	0	0	4	100S-C12⊗404BC
												3	1	0	4	100S-C12⊗304BC
16	32	5.5	7.5	7.5	7.5	1	3	5	5	10	15	4	0	0	4	100S-C16⊗404BC
												3	1	0	4	100S-C16⊗304BC
23	32	7.5	11	13	10	2	3	5	7-1/2	15	15	4	0	0	4	100S-C23⊗404BC
												3	1	0	4	100S-C23⊗304BC

(1) For other contact configurations and full product details, please contact your local Rockwell Automation sales office or Allen-Bradley distributor.



(2) If standard cross-stamped front-mount auxiliary contacts are required, remove the letter "B" before the letter "C" in the cat. no. Example: Cat. No. 100S-C09⊗404BC becomes Cat. No. 100S-C09-404C.

(3) Three-phase ratings only apply to contactors with at least three N.O. power poles.

⊗ Coil voltage code and terminal position — see [page 31](#).

## Reversing AC- and DC-Operated Contactors

- 3 Main Contacts
- Includes Mechanical/Electrical Interlock
- Includes Reversing Power Wiring

Rated Operational Current $I_e$ [A]		Ratings for switching AC motors - AC-2, AC-3, AC-4										Auxiliary Contacts		Cat. No. <sup>(1) (2)</sup>	
		3-phase kW (50 Hz)				Hp (60 Hz)									
40 °C	AC-3	AC-1	230V	400/415V	500V	690V	1-Phase		3-Phase						N.O.
							115V	230V	200V	230V	460V	575V			
9	32	3	4	4	4	1/2	1-1/2	2	2	5	7-1/2	0	6	104S-C09⊗012BC	
												1	5	104S-C09⊗210BC	
12	32	4	5.5	5.5	5.5	1/2	2	3	3	7-1/2	10	0	6	104S-C12⊗012BC	
												1	5	104S-C12⊗210BC	
16	32	5.5	7.5	7.5	7.5	1	3	5	5	10	15	0	6	104S-C16⊗012BC	
												1	5	104S-C16⊗210BC	
23	32	7.5	11	13	10	2	3	5	7-1/2	15	15	0	6	104S-C23⊗012BC	
												1	5	104S-C23⊗210BC	
30	65	10	15	15	15	2	5	7-1/2	10	20	25	0	5	104S-C30⊗010BC	
												1	5	104S-C30⊗210BC	
37	65	11	18.5/20	20	18.5	3	5	10	10	25	30	0	5	104S-C37⊗010BC	
												1	5	104S-C37⊗210BC	
43	85	13	22	25	22	3	7-1/2	10	15	30	30	0	5	104S-C43⊗010BC	
												1	5	104S-C43⊗210BC	
55	85	15	30	30	30	5	10	15	20	40	40	0	5	104S-C55⊗010BC	
												1	5	104S-C55⊗210BC	
60	100	18.5	32	37	32	5	10	15	20	40	50	0	5	104S-C60⊗010BC <sup>(4)</sup>	
												1	5	104S-C60⊗210BC <sup>(4)</sup>	
72	100	22	40	45	40	5	15	20	25	50	60	0	5	104S-C72⊗010BC <sup>(4)</sup>	
												1	5	104S-C72⊗210BC <sup>(4)</sup>	
85	100	25	45	55	45	7-1/2	15	25	30	60	60	0	5	104S-C85⊗010BC <sup>(4)</sup>	
												1	5	104S-C85⊗210BC <sup>(4)</sup>	
97	130	30	55	55	55	10	15	30	30	75	75	0	5	104S-C97⊗010BC <sup>(4)</sup>	
												1	5	104S-C97⊗210BC <sup>(4)</sup>	

- (1) For other contact configurations and full product details, please contact your local Rockwell Automation sales office or Allen-Bradley distributor.  
 (2) If standard cross-stamped front-mount auxiliary contacts are required, remove the letter "B" before the letter "C" in the cat. no. Example: Cat. No. 104S-C09⊗05BC becomes Cat. No. 104S-C09⊗05C.  
 (3) One of the N.C. auxiliary contacts is supplied as part of the mechanical/electrical interlock.  
 (4) Front- and side-mount auxiliary contacts on Cat. Nos. 104S-C60 . . . C97 conform to mirror contact performance only.

⊗ Coil voltage code and terminal position— see [page 31](#).

## Coil Voltage Codes

The Cat. No. as listed is incomplete. Select a coil voltage code from the table below to complete the Cat. No. Example: 120V, 60 Hz: Cat. No. 100S-C09005BC becomes Cat. No.100S-C09D05BC.

AC Voltages [V]	12	24	32	36	42	48	100	100... 110	110	120	127	200	200... 220	208	208... 240
50 Hz	R	K	V	W	X	Y	KP	—	D	P	S	KG	L	—	—
60 Hz	Q	J	—	V	—	X	—	KP	—	D	—	—	KG	H	L
50/60 Hz	—	KJ	—	—	—	KY	KP	—	KD	—	—	KG	KL <sup>(1)</sup>	—	—

(1) Not available on 100S/104S-C97 contactors.

AC Voltages [V]	220... 230	230	230... 240	240	277	347	380	380... 400	400	400... 415	440	480	500	550	600
50 Hz	F	—	VA	T	—	—	—	N	—	G	B	—	M	C	—
60 Hz	—	—	—	A	T	I	E	—	—	—	N	B	—	—	C
50/60 Hz	KL <sup>(1)</sup>	KF	—	KA	—	—	—	—	KN	—	KB	—	—	—	—

(1) Not available on 100S/104S-C97 contactors.

DC Voltages [V]		9	12	24	24	36	36...48	48	48...72	60	64
100S-C09...C55	Electronic with Integrated Diode	—	EQ	EJ	QJ <sup>(1)</sup>	—	EW	—	EY	—	—
100S-C60...C97	with Integrated Diode	DR	DQ	DJ	—	DW	—	DY	—	DZ	DB

(1) "QJ" coil has faster dropout time (16...21 ms).

DC Voltages [V]		72	80	110	110...125	115	125	220	220...250	230	250
100S-C09...C55	Electronic with Integrated Diode	—	—	—	ED	—	—	—	EA	—	—
100S-C60...C97	with Integrated Diode	DG	DE	DD	—	DP	DS	DA	—	DF	DT

## Coil Terminal Position

All contactors are delivered with the coil terminals located on the line side.

For load side coil terminations, insert a "U" prior to the coil voltage code. Ordering example: Cat. No. 100S-C09UD05BC.



Cat. No.100S-C09005CLine Side

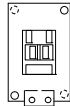

Cat. No.100S-C09U005CLoad Side

## Assignment of Contacts

### Safety Contactors with 3 Main Contacts and Standard Front-Mount Auxiliary Contacts

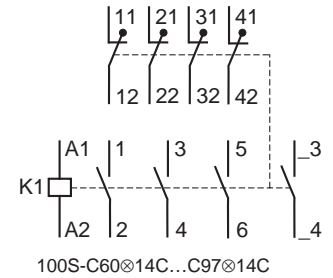
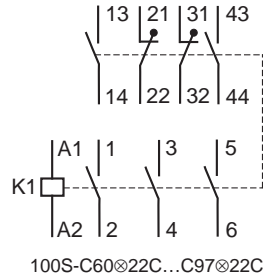
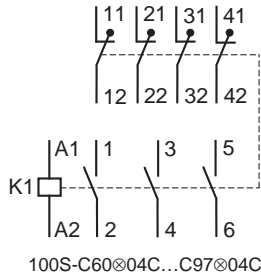
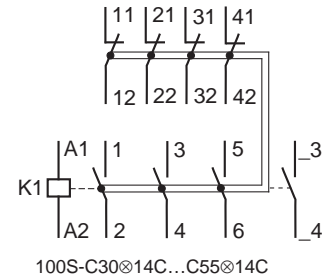
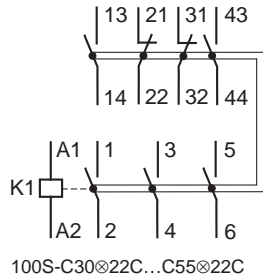
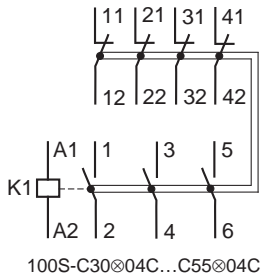
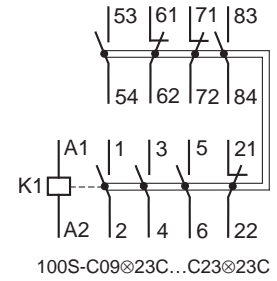
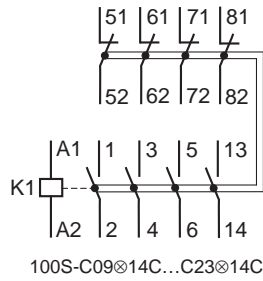
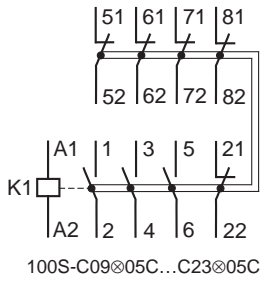



Safety Contactors with 4 Main Contacts and Standard Front-Mount Auxiliary Contacts

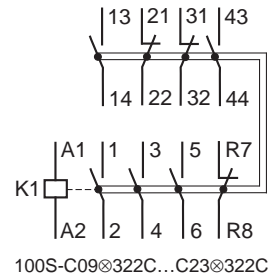
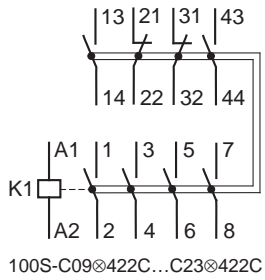
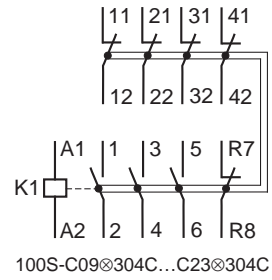
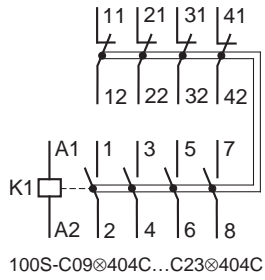

### Safety Reversing Contactors with 3 Main Contacts and Standard Front-Mount Auxiliary Contacts

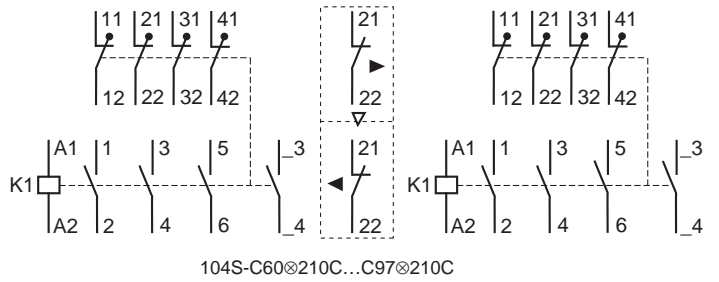
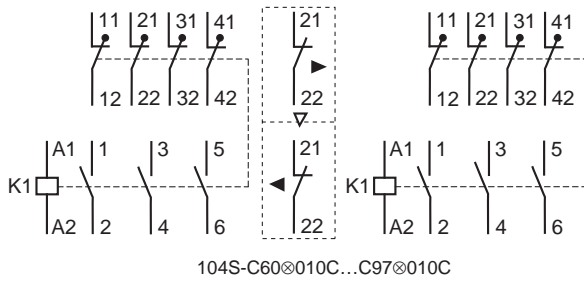
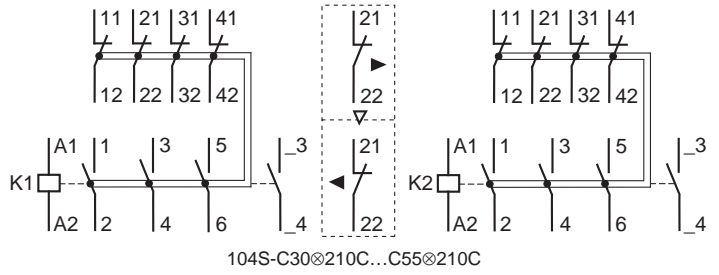
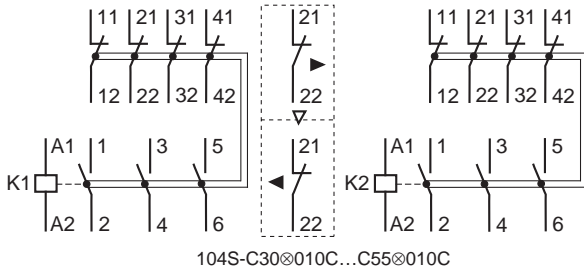
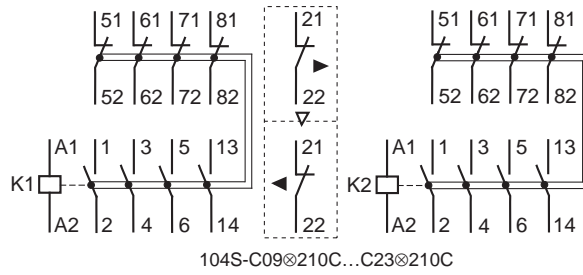
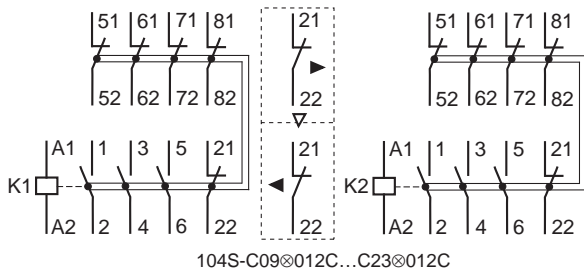

### Safety Contactors with 3 Main Contacts and Bifurcated Front-Mount Auxiliary Contacts

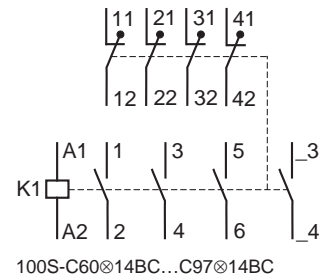
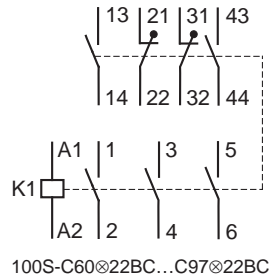
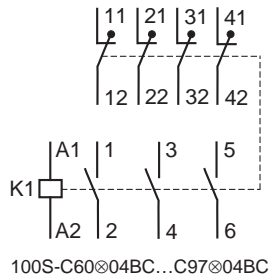
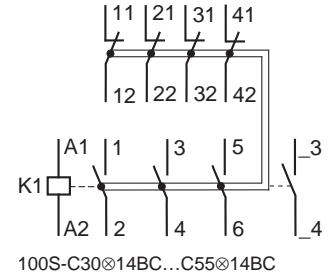
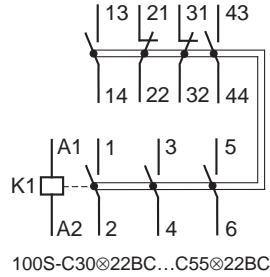
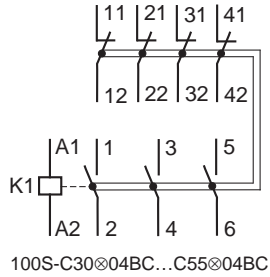
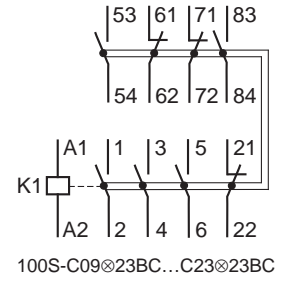
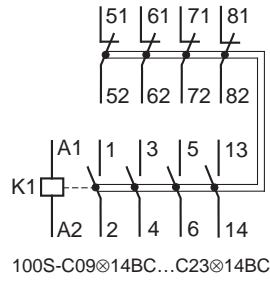
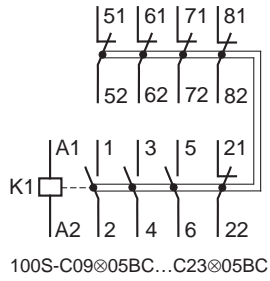

### Safety Contactors with 4 Main Contacts and Bifurcated Front-Mount Auxiliary Contacts

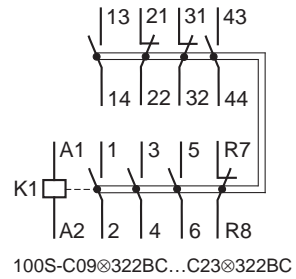
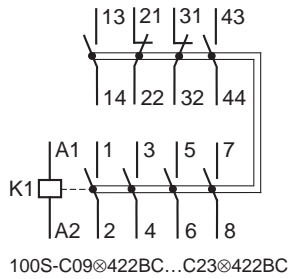
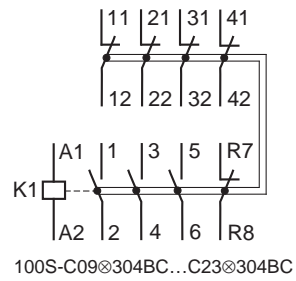
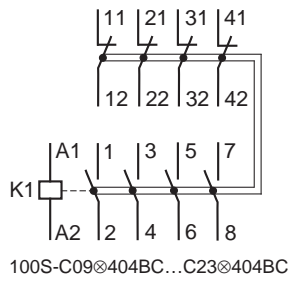

### Safety Reversing Contactors with 3 Main Contacts and Bifurcated Front-Mount Auxiliary Contacts

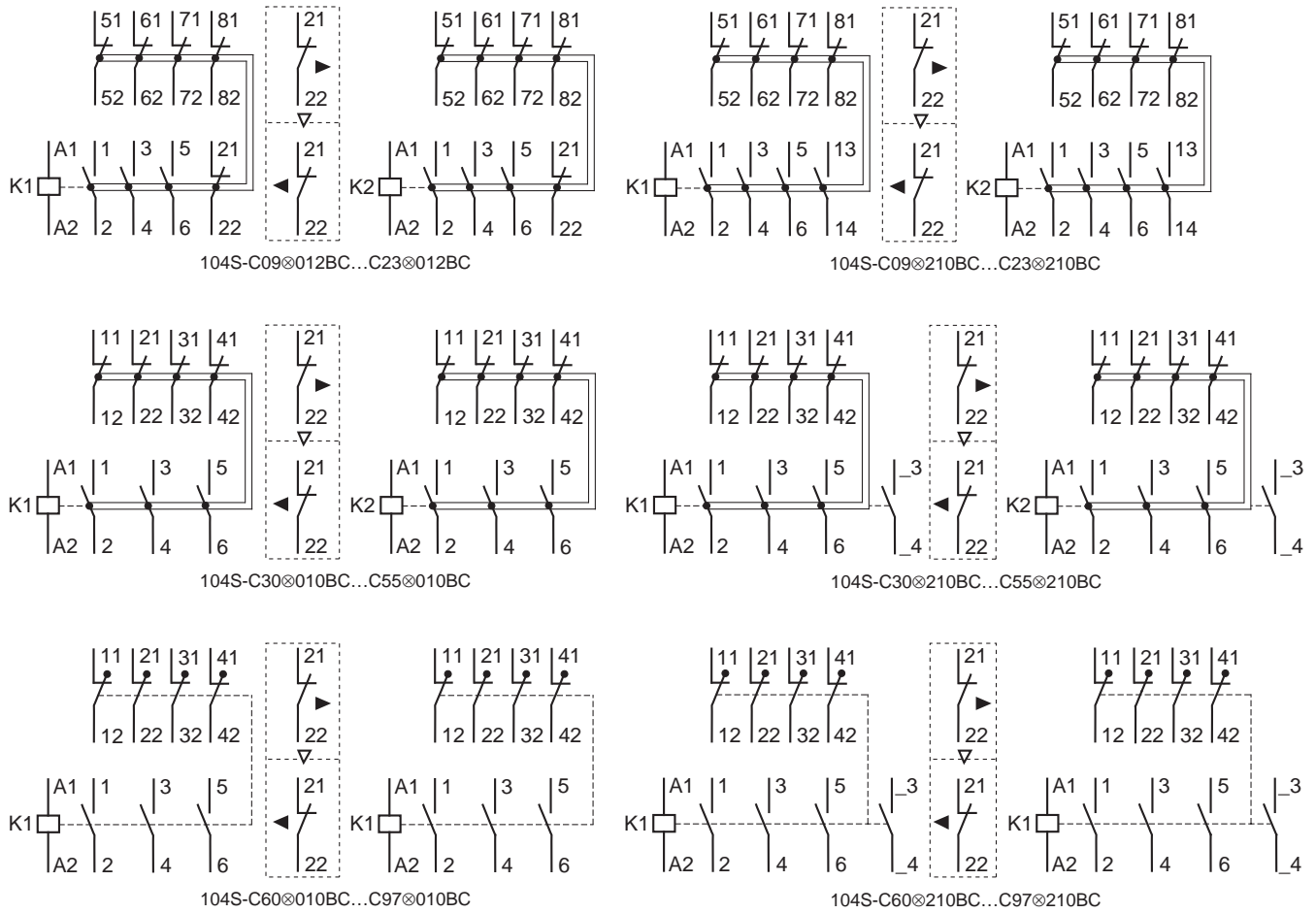

# Product Selection—100Q-C Capacitor-switching Contactors

- Compact sizes
- Limits high inrush currents
- AC and DC coil control
- Reversible coil terminals
- Panel or 35 mm DIN Rail mounting
- Environmentally friendly materials



The Bulletin 100Q-C Capacitor-Switching contactors are designed for switching banks of capacitors. The unique design uses front-mounted resistor elements that limit the severely high inrush currents seen in these applications. This reduces stress to the contactors and the capacitors, as well as allowing a more compact and economical design without the use of air-core reactors.

## For Applications per IEC 60947-4 (AC-6b)

Ratings for Switching Capacitor Banks @ 40 °C														
1-Phase 50 Hz (kVar)						3-Phase 50 Hz (kVar)						Aux. Contacts		Cat. No.
230V	240V	400V	415V	500V	690V	230V	240V	400V	415V	500V	690V	N.O.	N.C.	
5	5	8.5	9	10.5	15	8.5	8.5	15	15.5	18.5	25	1	1	100Q-C16⊗11
												2	0	100Q-C16⊗20
8	8.5	14	14.5	17.5	24	14	14	25	25	30	40	1	1	100Q-C37⊗11
												2	0	100Q-C37⊗20

Ratings for Switching Capacitor Banks @ 40 °C														
1-Phase 50 Hz (kVar)						3-Phase 50 Hz (kVar)						Aux. Contacts		Cat. No.
230V	240V	400V	415V	500V	690V	230V	240V	400V	415V	500V	690V	N.O.	N.C.	
5	5	8.5	9	10.5	15	8.5	8.5	15	15.5	18.5	25	1	1	100Q-C16⊗11
												2	0	100Q-C16⊗20
8	8.5	14	14.5	17.5	24	14	14	25	25	30	40	1	1	100Q-C37⊗11
												2	0	100Q-C37⊗20

## For Applications per UL/CSA

Ratings for Switching Capacitor Banks								
1-Phase 60 Hz (kVar)		3-Phase 60 Hz (kVar)				Aux. Contacts		Cat. No.
115V	230V	200V	230V	460V	600V	N.O.	N.C.	
2.2	4.5	6.5	7.5	15	18.5	1	1	100Q-C16⊗11
						2	0	100Q-C16⊗20
3.6	7.5	11	12.5	20	25	1	1	100Q-C37⊗11
						2	0	100Q-C37⊗20

⊗ Coil voltage code — see [page 39](#).

## Coil Voltage Codes

The Cat. No. as listed is incomplete. Select a coil voltage code from the table below to complete the Cat. No. Example: 120V, 60 Hz: Cat. No. 100Q-C16 $\otimes$ 11 becomes Cat. No.100Q-C16D11.

AC Voltages [V]	12	24	32	36	42	48	100	100... 110	110	120	127	200	200... 220	208	208... 240
50 Hz	R	K	V	W	X	Y	KP	—	D	P	S	KG	L	—	—
60 Hz	Q	J	—	V	—	X	—	KP	—	D	—	—	KG	H	L
50/60 Hz	—	KJ	—	—	—	KY	KP	—	KD	—	—	KG	KL	—	—

AC Voltages [V]	220... 230	230	230... 240	240	277	347	380	380... 400	400	400... 415	440	480	500	550	600
50 Hz	F	—	VA	T	—	—	—	N	—	G	B	—	M	C	—
60 Hz	—	—	—	A	T	I	E	—	—	—	N	B	—	—	C
50/60 Hz	KL	KF	—	KA	—	—	—	—	KN	—	KB	—	—	—	—

DC Voltages [V]	9	12	24	36	48	60	64	72
Electronic with Integrated Diode	—	EQ	EJ	—	—	—	—	—





DC Voltages [V]	80	110	110...125	115	125	220	220...250	230	250
Electronic with Integrated Diode	—	—	ED	—	—	—	EA	—	—

## Maximum Operational Rates

- 100Q-C16 200 operations/hour
- 100Q-C37 100 operations/hour

# Accessories

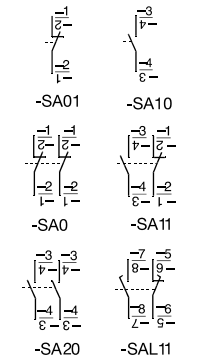
## Auxiliary Contact Blocks

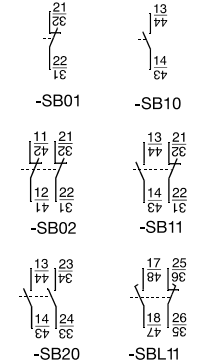









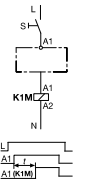
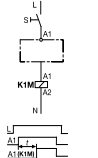

	Description <sup>(1)</sup>	Connection Diagrams			For Use With	Cat. No.	
			N.O.	N.C.		Standard Auxiliary Contact <sup>(2)</sup>	Bifurcated Auxiliary Contact
 <p><b>Auxiliary Contact Blocks for Front Mounting</b></p> <ul style="list-style-type: none"> <li>• 2- and 4-pole</li> <li>• Quick and easy mounting without tools</li> <li>• Electronic-compatible contacts down to 17V, 5mA</li> <li>• Mechanically linked performance between N.O. and N.C. poles and to the main contactor poles (except for L types)</li> <li>• Models with equal function with several terminal numbering choices</li> <li>• 1L = Late break N.C. / early make N.O.</li> <li>• Bifurcated version for switching down to 5V, 3 mA also available</li> </ul>			0	2	100-C all	100-FA02	100-FAB02
					C30⊗00...C97⊗00	100-FB02	100-FBB02
			1	1	100-C all	100-FA11	100-FAB11
					C30⊗00...C97⊗00	100-FB11	100-FBB11
					C09⊗10...C23⊗10	100-FC11	100-FCB11
			2	0	100-C all	100-FA20	100-FAB20
					C30⊗00...C97⊗00	100-FB20	100-FBB20
			1L	1L	100-C all	100-FAL11	—
					C30⊗00...C97⊗00	100-FBL11	—
			0	4	100-C all	100-FA04	100-FAB04
			1	3	100-C all	100-FA13	100-FAB13
			2	2	100-C all	100-FA22	100-FAB22
					C30⊗00...C97⊗00	100-FB22	100-FBB22
					C09⊗10...C23⊗10	100-FC22	100-FCB22
100-C all	100-FA31	100-FAB31					
C09⊗10...C23⊗10	100-FC31	100-FCB31					
100-C all	100-FA40	100-FAB40					
1+1L	1+1L	100-C all	100-FAL22	—			
 <p><b>Auxiliary Contact Blocks for Side Mounting without Sequence Terminal Designations</b></p> <ul style="list-style-type: none"> <li>• 1- and 2-pole</li> <li>• Two-way numbering for right or left mounting on the contactor</li> <li>• Quick and easy mounting without tools</li> <li>• Electronic-compatible contacts down to 17V, 10 mA</li> <li>• Mirror contact performance to the main contactor poles</li> <li>• 1L = Late break N.C. / early make N.O.</li> </ul>			0	1	100-C all	100-SA01	—
			1	0	100-C all	100-SA10	—
			0	2	100-C all	100-SA02	—
			1	1	100-C all	100-SA11	—
			2	0	100-C all	100-SA20	—
			1L	1L	100-C all	100-SAL11	—
 <p><b>Auxiliary Contact Blocks for Side Mounting with Sequence Terminal Designations</b></p> <ul style="list-style-type: none"> <li>• 1- and 2-pole</li> <li>• Two-way numbering for right or left mounting on the contactor</li> <li>• Quick and easy mounting without tools</li> <li>• Electronic-compatible contacts down to 17V, 10 mA</li> <li>• Mirror contact performance to the main contactor poles</li> <li>• 1L = Late break N.C. / early make N.O.</li> </ul>			0	1	100-C	100-SB01	—
			1	0	100-C <sup>(3)</sup>	100-SB10	—
			0	2	100-C <sup>(3)</sup>	100-SB02	—
			1	1	100-C <sup>(3)</sup>	100-SB11	—
			2	0	100-C <sup>(3)</sup>	100-SB20	—
			1L	1L	100-C <sup>(3)</sup>	100-SBL11	—
					100-C <sup>(3)</sup>	100-SBL11	—

(1) Max. number of auxiliary contacts that may be mounted:  
 AC and 24V DC electronic coil contactors—max. 4 N.O. contacts on the front of the contactor, 2 N.O. contacts on the side, 4 N.C. front or side, 6 total. DC Coil contactors—max. 4 N.O. contacts on the front of the contactor or max. 2 N.O. contacts on the side, 4 N.C. front or side, 4 total.  
 (2) For screwless terminals (front mount only), insert "CR" after the "100-" in the catalog number. Example: Cat. No. 100-FA02 becomes Cat. No. 100-CRFA02.  
 (3) Double numbering—Left-side mounting only is recommended for Cat. No. 100-C09...100-C23 due to double numbering.

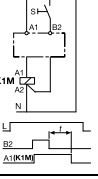
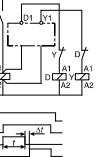

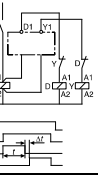
# Control Modules

## Timers

	Description	Connection Diagrams	For Use With	Cat. No.
	Pneumatic Timing Modules • Pneumatic timing element contacts switch after the delay time. The contacts on the main control relay continue to operate without delay	On-Delay, 0.3...30 s 	100-C or 700-CF with AC or 24V DC electronic coils <sup>(1)</sup>	100-FPTA30
		2...180 s		100-FPTA180
		Off-Delay 0.3...30 s 	100-C all, 700-CF all	100-FPTB30
		2...180 s		100-FPTB180
	Electronic Timing Modules — On-Delay • Delay of the contactor or control relay solenoid. The contactor or control relay is energized at the end of the delay time.	0.1...3 s 	100-C or 700-CF with 110...240V, 50/60Hz or 110...250V DC coils	100-ETA3
		1...30 s		100-ETA30
		10...180 s		100-ETA180
		0.1...3 s 	100-C or 700-CF with 24...48VDC coils	100-ETAZ3
		1...30 s		100-ETAZ30
		10...180 s		100-ETAZ180
	Electronic Timing Modules — Off-Delay • Delay of the contactor or control relay solenoid. After interruption of the control signal, the contactor or control relay is de-energized at the end of the delay time.	0.3...3 s 	100-C09...C37 or 700-CF with 24V 50/60Hz	100-ETBK3
		1...30 s		100-ETBK30
		10...180 s		100-ETBK180
		0.3...3 s 	100-C or 700-CF with 110...240V 50/60Hz coils	100-ETB3
		1...30 s		100-ETB30
		10...180 s		100-ETB180
	Electronic Timing Modules • Delay of the contactor solenoid. Contactor K 3 (Y) is de-energized (off) and K 2 (D) is energized (on) after the end of the set Y end time. (Switching delay at 50 ms.) • Continuous adjustment range • High repeat	Transition Time Y Contactor 1...30 s 	100-C with 110...240V 50/60Hz coils	100-ETY30
		Mechanical Interlocks • For interlocking of two contactors. • Common interlock for most Bul. 100-C contactor sizes • Interlocking or different sizes possible • Mechanical and electrical interlocking possible in one module by means of integrated auxiliary contacts • 9 mm dovetail connector included	Mechanical only, without auxiliary contacts 	100-C (except 100-C40, -C90)
	Mechanical Interlocks • For interlocking of two contactors. • Common interlock for most Bul. 100-C contactor sizes • Interlocking or different sizes possible • Mechanical and electrical interlocking possible in one module by means of integrated auxiliary contacts • 9 mm dovetail connector included	Mechanical/electrical interlock with 2 N.C. auxiliary contacts 	100-C (except 100-C40, -C90)	100-MCA02
		Mechanical Latch • Following contactor latching, the contactor coil is immediately de-energized (off) by the N.C. auxiliary contact (65-66). • Electrical or manual release • 1 N.O. + 1 N.C. auxiliary contacts • Suitable for all Bul. 100-C contactor sizes, 9...97 A	Maximum command duration 0.03...10 s 	100-C with AC or 24V DC electronic coils (except 100-C90)



(1) Cannot be used with side-mounted auxiliary contacts on 700-CF DC relays.

**Coil Voltage Code:** The Cat. No. as listed is incomplete. Select a coil voltage code from the table below to complete the Cat. No. Example: 120V, 60 Hz: Cat. No. 100-FL11⊗ becomes Cat. No.100-FL11D

AC Voltages [V] <sup>(1)</sup>	24	48	100	110	120	230...240	240	277	380...400	400...415	440	480
50 Hz	K	Y	KP	D	—	VA	KA	—	N	G	B	—
60 Hz	J	—	—	—	D	—	KA	T	—	—	N	B

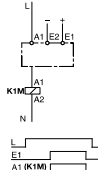

(1) For special voltages, consult your local Rockwell Automation sales office or Allen-Bradley distributor.

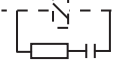
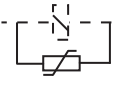
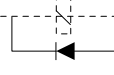
**Control Modules (For 100-C09...C97 contactors), Continued**

	Description		Voltage Range	Connection Diagrams	For Use With	Cat. No.
	DC Interface (Electronic) <ul style="list-style-type: none"> <li>Interface between the DC control signal (PLC) and the AC operating mechanism of the contactor.</li> <li>Requires no additional surge suppression on the relay coils.</li> </ul>		Input: 12V DC Output: 110...240V AC		100-C with AC coils 110...240V AC	100-JE12
			Input: 18...30V DC Output: 110...240V AC			100-JE
			Input: 48V DC Output: 110...240V AC			100-JE48
	RC Module AC operating mechanism	24...48V AC, 50/60 Hz		100-C with Coils	100-FSC48 <sup>(1)</sup>	
		110...280V AC, 50/60 Hz			100-FSC280 <sup>(1)</sup>	
		380...480V AC, 50/60 Hz			100-FSC480 <sup>(1)</sup>	
	Varistor Module AC/DC operating mechanism	12...55V AC, 12...77V DC		100-C with AC coils or 100-C09...-C43 with DC coils	100-FSV55 <sup>(1)</sup>	
		56...136V AC/78...180V DC			100-FSV136 <sup>(1)</sup>	
		137...277V AC/181...350V DC			100-FSV277 <sup>(1)</sup>	
		278...575V AC			100-FSV575 <sup>(1)</sup>	
	Diode Module DC operating mechanism	1...30 s 10...180 s		100-C09...-C43 with DC coils	100-FSD250 <sup>(1)</sup>	

(1) For screwless terminals, insert "CR" after the "100-" in the catalog number. Example: Cat No. 100-FSC48 becomes Cat. No.-CRFSC48.

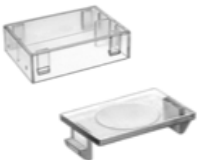
**Assembly Components (For 100-C09...C97 contactors)**

	Description	For Use With	Pkg. Qty.	Cat. No.
	Dovetail Connectors <ul style="list-style-type: none"> <li>For use in contactor and starter assemblies</li> <li>Single Connector — 0 mm spacing</li> </ul>	100-C	10	100-S0
	Dovetail Connectors <ul style="list-style-type: none"> <li>For use in contactor and starter assemblies</li> <li>Single Connector — 9mm spacing</li> </ul>		10	
	Protective Covers <ul style="list-style-type: none"> <li>Provides protection against unintended manual operation</li> <li>For contactors and front-mounted auxiliary contacts, pneumatic timers, and latches</li> </ul>	100-C all	1	100-SCCA
		100-FA, -FB, -FC, -FP, -FL	10	100-SCFA
	Reversing Power Wiring Kits <ul style="list-style-type: none"> <li>For reversing connection with a solid-state or thermal overload relay</li> </ul>	100-C09...C23	1	105-PW23
		100-C30...C37	1	105-PW37
		100-C43...C55	1	105-PW55
		100-C60...C97	1	105-PW85
	DIN (#3) symmetrical hat rail <ul style="list-style-type: none"> <li>35 x 7.5 x 1 m</li> </ul>	140M-D 140M-F 100-C all	10	199-DR1



## Wye-Delta/Star-Delta Starter Kits

Wye-Delta power wiring kits are designed to aid in the field assembly of open-transition wye-delta starters that use Bulletin 100-C contactors. These kits include line, load, and start-point (shorting) connections. Assembling a wye-delta starter requires the use of the following additional components:

- Contactors
- Overload Relay
- Cat. No. 100-MCA02 Mechanical/Electrical Interlock Cat. No. 100-ETY30 Electronic Y- Timer
- Cat. No. 100-S9 Base Coupler for 1M to 2M contactor (optional)



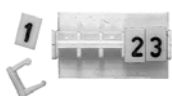

	3-Phase Rating											Pkg Qty.	Cat. No.
	kW (50 Hz)				Hp (60 Hz)				Use with Cat. No. 100-				
	230V	380/ 415V	500V	690V	200V	230V	460V	575V	Delta		Wye		
									1M	2M	1S		
	5.5	7.5	7.5	7.5	5	5	10	10	C09	C09	C09	1	170-PW23
	7.5	11	11	10	5	7.5	15	15	C12	C12	C09	1	170-PW23
	10	15	15	13	7.5	10	20	20	C16	C16	C12	1	170-PW23
	13	22	22	18.5	7.5	10	25	25	C23	C23	C12	1	170-PW23
	17	25	25	25	10	15	30	30	C30	C30	C16	1	170-PW37
	20	37	32	32	15	20	40	40	C37	C37	C23	1	170-PW37
	22	40	40	40	20	25	50	50	C43	C43	C30	1	170-PW55
	30	45	45	45	25	30	60	60	C55	C55	C37	1	170-PW55
	32	55	55	55	30	40	75	75	C60	C60	C37	1	170-PW72
	40	63	63	63	40	50	100	100	C72	C72	C43	1	170-PW72
	50	80	80	80	50	60	125	125	C85	C85	C60	1	170-PW85
	50	90	90	90	50	60	125	125	C97	C97	C60	1	170-PW85

### Marking Systems (For 100-C09...C97 contactors)

	Description	Pkg. Qty. <sup>(1)</sup>	Cat. No.
	Label Sheet • 105 self-adhesive paper labels each, 6 x 17 mm	10	100-FMS
	Marking Tag Sheet • 106 perforated paper labels each, 6 x 17 mm, to be used with a transparent cover	10	100-FMP
	Transparent Cover • To be used with marking tag sheets	100	100-FMC
	Marking Tag Adapters • To be used with marking tag: System V7	100	100-FMA1
	Marking Tag Adapters • To be used with marking tag: System 1492 W	100	100-FMA2

(1) Must be ordered in multiples of package quantities

**Terminal Kits (For 100-C09...C97 contactors)**

	Description	Max. Current Ratings and Wire Sizes		Pkg. Qty <sup>(2)</sup>	Cat. No.
	Stab Connector Kit • Dual stab (0.250 in.) for 100-C coil terminals • For 100-C09...C97 contactors			20	199-SC2
	Stab Connector Kit • Dual stab (0.250 in.) for 100-C power terminals • For 100-C09...C23 contactors			100	199-SC10
	3-Pole Terminal Lug Kit • For Cat. No. 100-C09...C23 (Line side)	IEC @ 40 °C IEC @ 40 °C UL/CSA (Encl.)	45 A (4...16 mm <sup>2</sup> , fine stranded w/ ferrule) <sup>(1)</sup> 45 A (4...25 mm <sup>2</sup> , coarse stranded/solid) 40 A (#10...4 AWG, stranded/solid)	1	100-CTN23
	3-Pole Terminal Lug Kit • For Cat. No. 100-C09...C23 (Load side)	IEC @ 40 °C IEC @ 40 °C UL/CSA (Encl.)	45 A (4...16 mm <sup>2</sup> , fine stranded w/ ferrule) 45 A (4...25 mm <sup>2</sup> , coarse stranded/solid) 40 A (#10...4 AWG, stranded/solid)	1	100-CTL23
	3-Pole Terminal Lug Kit • For Cat. No. 100-C30...C37 (Line and load side)	IEC @ 40 °C IEC @ 40 °C UL/CSA (Encl.)	60 A (4...16 mm <sup>2</sup> , fine stranded w/ ferrule) 60 A (4...25 mm <sup>2</sup> , coarse stranded/solid) 55 A (#10...4 AWG, stranded/solid)	1	100-CT37
	1-Pole Terminal Lug Kit • For Cat. No. 100-C43	IEC @ 40 °C IEC @ 40 °C UL/CSA (Encl.)	90 A (6...35 mm <sup>2</sup> , fine stranded w/ ferrule) 90 A (6...50 mm <sup>2</sup> , coarse stranded/solid) 75 A (#8...2 AWG, stranded/solid)	3	100-CT43
	1-Pole Terminal Lug Kit • For Cat. No. 100-C60...C97	IEC @ 40 °C IEC @ 40 °C UL/CSA (Encl.)	130 A (10...70 mm <sup>2</sup> , fine stranded w/ ferrule) 130 A (10...95 mm <sup>2</sup> , coarse stranded/solid) 130 A (#8...2/0 AWG, stranded/solid)	3	100-CT85
	3-Pole Paralleling Kit • For Cat. No. 100-C09...C23	IEC @ 40 °C IEC @ 40 °C UL/CSA (Encl.)	100 A (35...70 mm <sup>2</sup> , fine stranded w/ ferrule) 100 A (35...95 mm <sup>2</sup> , coarse stranded/solid) 100 A (#0...2/0 AWG, stranded/solid)	2	100-CP23
	3-Pole Paralleling Kit • For Cat. No. 100-C30...C37	IEC @ 40 °C IEC @ 40 °C UL/CSA (Encl.)	150 A (35...70 mm <sup>2</sup> , fine stranded w/ ferrule) 150 A (35...95 mm <sup>2</sup> , coarse stranded/solid) 150 A (#0...2/0 AWG, stranded/solid)	2	100-CP37

(1) 16 mm<sup>2</sup> max. according to IEC 60947; actual max. 25 mm<sup>2</sup>  
 (2) Must be ordered in multiples of the package quantity.

**SEMI-F47 Voltage Sag Immunity Module**

	Description	Input Voltage	For Use With <sup>(1)</sup>	Options	Cat. No.
	SEMI-F47 Module • Meets SEMI-F47 voltage sag immunity requirements • Direct mounting to coil terminals of 100-C contactors and 700-CF control relays • Requires DC coil contactor • Optional 1...30 s ON-delay timer version	24...240V AC	100-C60...C97	without timer	100-CSF47
		110...240V AC	100-C60...C97	with 1...30 s ON-delay timer	100-CSF47A30

(1) Contactor must have DC coil at the same voltage as AC input. Example: for 24V AC control, select Cat. No. 100-C09ZJ10 (24V DC coil).

# Renewal Parts

## Replacement Coils for AC Contactors



AC Standard Control Voltages [V]			AC Coil Code	100-C09...100-C16	100-C23...100-C37, 100L-C20	100-C40, -C43	100-C60...100-C85	100-C90...100-C97
50 Hz	60 Hz	50/60 Hz		Cat. No.	Cat. No.	Cat. No.	Cat. No.	Cat. No.
—	12	—	Q	TA006	TC006	TD006	TE006	TF006
12	—	—	R	TA404	TC404	TD404	TE404	TF404
—	24	—	J	TA013	TC013	TD013	TE013	TF013
24	—	—	K	TA407	TC407	TD407	TE407	TF407
—	—	24	KJ	TA855	TC855	TD855	TE855	TF855
32	36	—	V	TA481	TC481	TD481	TE481	TF481
36	42	—	W	TA410	TC410	TD410	TE410	TF410
42	48	—	X	TA482	TC482	TD482	TE482	TF482
48	—	—	Y	TA414	TC414	TD414	TE414	TF414
—	—	48	KY	TA860	TC860	TD860	TE860	TF860
100	100...110	100	KP	TA861	TC861	TD861	TE861	TF861
110	120	—	D	TA473	TC473	TD473	TE473	TF473
—	—	110	KD	TA856	TC856	TD856	TE856	TF856
120	—	—	P	TA425	TC425	TD425	TE425	TF425
127	—	—	S	TA428	TC428	TD428	TE428	TF428
200	200...220	200	KG	TA862	TC862	TD862	TE862	TF862
—	208	—	H	TA049	TC049	TD049	TE049	TF049
200...220	208...240	—	L	TA296	TC296	TD296	TE296	TF296
—	—	200...230	KL	TA864	TC864	TD864	TE864	—
220	240	—	A	TA474	TC474	TD474	TE474	TF474
220...230	260	—	F	TA441	TC441	TD441	TE441	TF441
—	—	230	KF	TA851	TC851	TD851	TE851	TF851
230...240	—	—	VA	TA440	TC440	TD440	TE440	TF440
240	277	—	T	TA480	TC480	TD480	TE480	TF480
—	—	240	KA	TA858	TC858	TD858	TE858	TF858
—	347	—	I	TA065	TC065	TD065	TE065	TF065
—	380	—	E	TA067	TC067	TD067	TE067	TF067
380...400	440	—	N	TA071	TC071	TD071	TE071	TF071
—	—	400	KN	TA863	TC863	TD863	TE863	TF863
400...415	—	—	G	TA457	TC457	TD457	TE457	TF457
440	480	—	B	TA475	TC475	TD475	TE475	TF475
—	—	440	KB	TA859	TC859	TD859	TE859	TF859
500	—	—	M	TA479	TC479	TD479	TE479	TF479
550	600	—	C	TA476	TC476	TD476	TE476	TF476

## Replacement Coils for DC Contactors



DC Control Voltage [V]	DC Coil Code	100-C09...100-C16, 100Q-C16	100-C23...100-C37, 100Q-C37	100-C40...100-C55 (Series A)	100-C40...100-C55 (Series B)	100-C60...100-C85	100-C90...100-C97
		Cat. No.	Cat. No.	Cat. No.	Cat. No.	Cat. No.	Cat. No.
9V Diode <sup>(1)</sup>	DR	—	—	—	—	TE766M	TF766M
12V Electronic <sup>(2)</sup>	EQ	TC708E	TC708E	TD708E	TD708E2	—	—
12V Diode	DQ	—	—	—	—	TE708M	TF708M
24V Electronic <sup>(2)</sup>	EJ	TC714E	TC714E	TD714E	TD714E2	—	—
24V Electronic <sup>(3)</sup>	QJ	TC714Q	TC714Q	TD714Q	TD714Q2	—	—
24V Diode <sup>(2)</sup>	DJ	—	—	—	—	TE714M	TF714M
36...48V Electronic <sup>(2)</sup>	EW	TC719E	TC719E	TD719E	TD719E2	—	—
36V Diode	DW	—	—	—	—	TE719M	TF719M
48...72V Electronic	EY	TC724E	TC724E	TD724E	TD724E2	—	—
48V Diode	DY	—	—	—	—	TE724M	TF724M
60V Diode	DZ	—	—	—	—	TE774M	TF774M
64V Diode	DB	—	—	—	—	TE727M	TF727M
72V Diode	DG	—	—	—	—	TE728M	TF728M
80V Diode	DE	—	—	—	—	TE729M	TF729M
110...125V Electronic <sup>(4)</sup>	ED	TC733E	TC733E	TD733E	TD733E2	—	—
110V Diode	DD	—	—	—	—	TE733M	TF733M
115V Diode	DP	—	—	—	—	TE734M	TF734M
125V Diode	DS	—	—	—	—	TE737M	TF737M
220...250V Electronic	EA	TC747E	TC747E	TD747E	TD747E2	—	—
220V Diode	DA	—	—	—	—	TE747M	TF747M
230V Diode	DF	—	—	—	—	TE749F	TF749F
250V Diode	DT	—	—	—	—	TE751F	TF751F

(1) Voltage operating range: 0.65...1.3 U<sub>s</sub>

(2) Voltage operating range: 0.7...1.25 U<sub>s</sub>

(3) Faster drop-out time (16...21 ms)

(4) Voltage operating range: 0.7...1.25 U<sub>s</sub> at 110V DC

# Specifications

			100/104-C, 100S/104S-C															
			09	12	16	23	30	37	40*200	40*400	43	55	60	72	85	90*200	90*400	97
Coil Type:	Conventional	X	X	X	X	X	X	X	X	X	X	X	X	X	X	X	X	X
	Electronic — EI	X	X	X	X	X	X	X	X	X	X	X	—	—	—	—	—	—
AC-1 Active Power Load (50 Hz); Ambient temperature 40 °C																		
Rated Operational Current, $I_e$	≤500V	[A]	32	32	32	32(40) <sup>(1)</sup>	65	65	75	75	85	85	100	100	100	130	130	130
	690V	[A]	32	32	32	32(40) <sup>(1)</sup>	65	65	75	75	85	85	100	100	100	130	130	130
Rated Operational Power, $P_e$	230V	[kW]	13	13	13	13	26	26	30	30	34	34	40	40	40	52	52	52
	240V	[kW]	13	13	13	13	27	27	31	31	35	35	42	42	42	54	54	54
	400V	[kW]	22	22	22	22	45	45	52	52	59	59	69	69	69	90	90	90
	415V	[kW]	23	23	23	23	47	47	54	54	61	61	72	72	72	93	93	93
	500V	[kW]	28	28	28	28	56	56	65	65	74	74	87	87	87	113	113	113
	690V	[kW]	38	38	38	38	78	78	90	90	102	102	120	120	120	155	155	155
AC-1 Active Power Load (50 Hz); Ambient temperature 60 °C																		
Rated Operational Current, $I_e$	≤500V	[A]	32	32	32	32	65	65	60	60	75	75	100	100	100	110	110	110
	690V	[A]	32	32	32	32	65	65	60	60	75	75	100	100	100	110	110	110
Rated Operational Power, $P_e$	230V	[kW]	13	13	13	13	26	26	24	24	25	25	40	40	40	44	44	44
	240V	[kW]	13	13	13	13	27	27	25	25	26	26	42	42	42	46	46	46
	400V	[kW]	22	22	22	22	45	45	42	42	44	44	69	69	69	76	76	76
	415V	[kW]	23	23	23	23	47	47	43	43	45	45	72	72	72	79	79	79
	500V	[kW]	28	28	28	28	56	56	52	52	55	55	87	87	87	95	95	95
	690V	[kW]	38	38	38	38	78	78	72	72	75	75	120	120	120	131	131	131
Switching of 3-phase Motors; (50 Hz) Ambient temperature 60 °C, AC-2, AC-3																		
Rated Operational Current, $I_e$	230V	[A]	12	15	20	26.5	35	38	38	38	44	56	62	72	85	85	85	96
	240V	[A]	12	15	20	26.5	35	38	38	38	44	56	62	72	85	85	85	95
	400V	[A]	9	12	16	23	30	37	37	37	43	55	60	72	85	85	85	97
	415V	[A]	9	12	16	23	30	37	37	37	43	55	60	72	85	85	85	97
	500V	[A]	7	10	14	20	25	30	29	30	38	44	55	67	80	80	80	78
	690V	[A]	5	7	9	12	18	21	9	21	25	25	34	42	49	22	49	57
Rated Operational Power, $P_e$	230V	[kW]	3	4	5.5	7.5	10	11	11	11	13	15	18.5	22	25	25	25	30
	240V	[kW]	3	4	5.5	7.5	10	11	11	11	13	15	18.5	22	25	25	25	30
	400V	[kW]	4	5.5	7.5	11	15	18.5	18.5	18.5	22	30	32	40	45	45	45	55
	415V	[kW]	4	5.5	7.5	11	15	20	20	20	22	30	32	40	45	45	45	55
	500V	[kW]	4	5.5	7.5	13	15	20	18.5	20	25	30	37	45	55	55	55	55
	690V	[kW]	4	5.5	7.5	10	15	18.5	7.5	18.5	22	22	32	40	45	18.5	45	55
Load Carrying Capacity per UL/CSA																		
General Purpose Current (enclosed)	[A]	25	25	30	30	55	60	60	60	75	75	90	90	100	125	130	120	
Rated power (enclosed) 1-phase	115V	[A]	9.8	9.8	16	24	24	34	34	34	34	56	56	56	80	80	80	100
	230V	[A]	10	12	17	17	28	28	28	28	40	50	50	68	68	68	68	88
	115V	[Hp]	0.5	0.5	1	2	2	3	3	3	3	5	5	5	7.5	7.5	7.5	10
	230V	[Hp]	1.5	2	3	3	5	5	5	5	7.5	10	10	15	15	15	15	20
Rated power (enclosed) 3-phase	200V	[A]	7.8	11	17.5	17.5	25.3	32.2	32.2	32.2	32.2	48.3	48.3	62.1	78.2	78.2	78.2	92
	230V	[A]	6.8	9.6	15.2	22	28	28	28	28	42	54	54	68	80	80	80	80
	460V	[A]	7.6	11	14	21	27	34	34	34	40	52	52	65	77	65	77	96
	575V	[A]	9	11	17	17	27	32	17	32	32	41	52	62	62	22	52	77
	200V	[Hp]	2	3	5	5	7.5	10	10	10	10	15	15	20	25	25	25	30
	230V	[Hp]	2	3	5	7.5	10	10	10	10	15	20	20	25	30	30	30	30
	460V	[Hp]	5	7.5	10	15	20	25	25	25	30	40	40	50	60	50	60	75
575V	[Hp]	7.5	10	15	15	25	30	15	30	30	40	50	60	60	20	50	75	

(1) Values in () with increased cross-section and cable lug

			100/104-C, 100S/104S-C											
			09	12	16	23	30	37	43	55	60	72	85	97
Coil Type:	Conventional		X	X	X	X	X	X	X	X	X	X	X	X
	Electronic — EI		X	X	X	X	X	X	X	X	X	—	—	—
<b>Switching of 3-phase Motors, (50 Hz); Ambient temperature 60 °C, AC-4</b>														
Rated Operational Current, $I_e$	230V	[A]	12	15	20	26.5	35	38	44	56	62	72	85	96
	240V	[A]	12	15	20	26.5	35	38	44	56	62	72	85	95
	400V	[A]	9	12	16	23	30	37	43	55	60	72	85	97
	415V	[A]	9	12	16	23	30	37	43	55	60	72	85	97
	500V	[A]	7	10	14	20	25	30	38	44	55	67	80	78
	690V	[A]	5	7	9	12	18	21	25	25	34	42	49	57
Rated Operational Power, $P_e$	230V	[kW]	3	4	5.5	7.5	10	11	13	15	18.5	22	25	30
	240V	[kW]	3	4	5.5	7.5	10	11	13	15	18.5	22	25	30
	400V	[kW]	4	5.5	7.5	11	15	18.5	22	30	32	40	45	55
	415V	[kW]	4	5.5	7.5	11	15	20	22	30	32	40	45	55
	500V	[kW]	4	5.5	7.5	13	15	20	25	30	37	45	55	55
	690V	[kW]	4	5.5	7.5	10	15	18.5	22	22	32	40	45	55
<b>AC-4 at approximately 200,000 operations</b>														
Rated Operational Current, $I_e$	230V	[A]	4.3	6.6	9	9	12	14	16.5	22	25.5	31	38	44
	240V	[A]	4.3	6.6	9	9	12	14	16.5	22	25.5	31	38	44
	400/415V	[A]	4.3	6.6	9	9	12	14	16.5	22	25.5	31	38	44
	500V	[A]	4.3	6.6	9	9	12	14	16.5	22	25.5	31	38	44
	690V	[A]	4.3	6.6	9	9	12	14	16.5	22	25.5	31	38	44
Rated Operational Power, $P_e$	230V <sup>(1)</sup>	[kW]	0.75	1.5	2.2	2.2	3	3.7	4	5.5	6.3	7.5	11	11
	240V <sup>(1)</sup>	[kW]	0.75	1.5	2.2	2.2	3	4	4	5.5	7.5	7.5	11	11
	400V <sup>(1)</sup>	[kW]	1.8	3	4	4	5.5	6.3	7.5	11	13	15	20	22
	415V <sup>(1)</sup>	[kW]	1.8	3	4	4	5.5	6.3	7.5	11	13	17	20	22
	500V <sup>(1)</sup>	[kW]	2.2	3.7	5.5	5.5	7.5	7.5	10	11	15	20	25	30
	690V <sup>(1)</sup>	[kW]	3	5.5	7.5	7.5	10	11	15	18.5	22	25	32	37
Max. switching frequency		Ops/hour	250	250	220	200	200	200	200	200	120	120	120	120
Wye-Delta (60 Hz)	200V	[Hp]	5	5	7½	7½	10	15	20	25	30	40	50	50
	230V	[Hp]	5	7½	10	10	15	20	25	30	40	50	60	60
	460V	[Hp]	10	15	20	25	30	40	50	60	75	100	125	125
	575V	[Hp]	10	15	20	25	30	40	50	60	75	100	125	125
UL/CSA Elevator Duty	200V	[A]	7.8	11.0	11.0	17.5	25.3	25.3	32.2	TBD	32.2	48.3	62.1	TBD
	230V	[A]	6.8	9.6	15.2	15.2	22.0	28.0	28.0	TBD	42.0	54.0	68.0	TBD
	460V	[A]	7.6	11.0	04.0	21.0	27.0	27.0	34.0	TBD	40.0	52.0	65.0	TBD
	575V	[A]	6.1	9.0	11.0	17.0	22.0	27.0	32.0	TBD	41.0	52.0	62.0	TBD
	200V	[Hp]	2	3	3	5	7-1/2	7-1/2	10	TBD	10	15	20	TBD
	230V	[Hp]	2	3	5	5	7-1/2	10	10	TBD	15	20	25	TBD
	460V	[Hp]	5	7-1/2	10	15	20	20	25	TBD	30	40	50	TBD
	575V	[Hp]	5	7-1/2	10	15	20	25	30	TBD	40	50	60	TBD

(1) Power ratings at 50 Hz; Preferred values according to IEC 60072-1



			100/104-C, 100S/104S-C											
			09	12	16	23	30	37	43	55	60	72	85	97
Coil Type:	Conventional		X	X	X	X	X	X	X	X	X	X	X	X
	Electronic — EI		X	X	X	X	X	X	X	X	—	—	—	—
Star-Delta Starting (50 Hz)														
Rated Operational Current, $I_e$	≤ 230V	[A]	21	26	35	46	61	66	76	96	107	125	147	166
	≤ 240V	[A]	21	26	35	46	61	66	76	96	107	125	147	165
	400V	[A]	16	21	28	40	52	64	74	95.3	104	125	147	168
	415V	[A]	16	21	28	40	52	64	74	95.3	104	125	147	168
	500V	[A]	12	17	24	35	43	52	66	76.2	95	116	139	135
	690V	[A]	8.6	12	16	21	31	36	43	55.4	59	73	85	99
Rated Operational Power, $P_e$	230V <sup>(1)</sup>	[kW]	5.5	7.5	10	13	17	20	22	30	32	37	45	50
	240V <sup>(1)</sup>	[kW]	5.5	7.5	10	13	18.5	20	22	30	32	40	50	50
	400V <sup>(1)</sup>	[kW]	7.5	10	13	20	25	32	40	45	55	63	80	90
	415V <sup>(1)</sup>	[kW]	7.5	11	15	22	25	32	40	45	55	63	80	90
	500V <sup>(1)</sup>	[kW]	7.5	11	15	22	25	32	45	45	63	80	90	90
	690V <sup>(1)</sup>	[kW]	7.5	10	13	18.5	25	32	40	45	55	63	80	90

Switching of Power Transformers, AC-6a (50 Hz)

Inrush Current

Rated transformer current = n

n=30	≤ 230V	[A]	10.9	10.9	10.9	10.9	20	20	23	23	40.8	40.8	40.8	48.5
	≤ 240V	[A]	10.9	10.9	10.9	10.9	20	20	23	23	40.8	40.8	40.8	48.5
	≤ 400V	[A]	10.9	10.9	10.9	10.9	20	20	23	23	40.8	40.8	40.8	48.5
	≤ 415V	[A]	10.9	10.9	10.9	10.9	20	20	23	23	40.8	40.8	40.8	48.5
	≤ 500V	[A]	10.9	10.9	10.9	10.9	20	20	23	23	40.8	40.8	40.8	48.5
	≤ 690V	[A]	10.9	10.9	10.9	10.9	20	20	23	23	40.8	40.8	40.8	48.5
Apparent Power	230V	[kVA]	4.3	4.3	4.3	4.3	8	8	9.2	9.2	16	16	16	19.3
	240V	[kVA]	4.5	4.5	4.5	4.5	8.3	8.3	10	10	17	17	17	20.2
	400V	[kVA]	7.5	7.5	7.5	7.5	14	14	16	16	28	28	28	33.6
	415V	[kVA]	7.8	7.8	7.8	7.8	14	14	17	17	29	29	29	34.9
	500V	[kVA]	9.4	9.4	9.4	9.4	17	17	20	20	35	35	35	42
	690V	[kVA]	13	13	13	13	24	24	27	27	49	49	49	58
n=20	≤ 690V	[A]	16.3	16.3	16.3	16.3	30	30	34.5	34.5	61.3	61.3	61.3	72.8
n=15	≤ 690V	[A]	22	22	22	22	40	40	46	46	82	82	82	97

60 Hz Peak Inrush/peak rated transformer current

n=30		[A]	10.9	10.9	10.9	10.9	20	20	23	23	40.8	40.8	40.8	48.5
Apparent Power	200V	[kVA]	3.8	3.8	3.8	3.8	6.9	6.9	8.0	8	14.1	14.4	14.4	16.8
	208V	[kVA]	3.9	3.9	3.9	3.9	7.2	7.2	8.3	8.3	14.7	14.7	14.7	17.5
	240V	[kVA]	4.5	4.5	4.5	4.5	8.3	8.3	9.6	9.6	17.0	17.0	17.0	20.2
	480V	[kVA]	9.1	9.1	9.1	9.1	16.6	16.6	19.1	19.1	33.9	33.9	33.9	40.3
	600V	[kVA]	11.3	11.3	11.3	11.3	20.8	20.8	23.9	23.9	42.4	42.4	42.4	50.4
	660V	[kVA]	12.5	12.5	12.5	12.5	22.9	22.9	26.3	26.3	46.6	46.6	46.6	55.4

60 Hz Peak Inrush/peak rated transformer current

n=20		[A]	16.3	16.3	16.3	16.3	30	30	34.5	34.5	61.3	61.3	61.3	72.8
Apparent Power	200V	[kVA]	5.6	5.6	5.6	5.6	10.4	10.4	12.0	12	21.2	21.2	21.2	25.2
	208V	[kVA]	5.9	5.9	5.9	5.9	10.8	10.8	12.4	12.4	22.1	22.1	22.1	26.2
	240V	[kVA]	6.8	6.8	6.8	6.8	12.5	12.5	14.3	14.3	25.5	25.5	25.5	30.3
	480V	[kVA]	13.6	13.6	13.6	13.6	24.9	24.9	28.7	28.7	51.0	51.0	51.0	60.5
	600V	[kVA]	16.9	16.9	16.9	16.9	31.2	31.2	35.9	35.9	63.7	63.7	63.7	75.7
	660V	[kVA]	18.6	18.6	18.6	18.6	34.3	34.3	39.4	39.4	70.1	70.1	70.1	83.2

(1) Power ratings at 50 Hz: Preferred values according to IEC 60072-1

		100/104-C, 100S/104S-C											
		09	12	16	23	30	37	43	55	60	72	85	97
Coil Type:	Conventional	X	X	X	X	X	X	X	X	X	X	X	X
	Electronic — EI	X	X	X	X	X	X	X	X	X	—	—	—
<b>60 Hz Peak Inrush/peak rated transformer current</b>													
n=15	[A]	22	22	22	22	40	40	46	46	82	82	82	97
Apparent Power	200V [kVA]	7.5	7.5	7.5	7.5	13.9	13.9	15.9	15.9	28.4	28.4	28.4	33.6
	208V [kVA]	7.8	7.8	7.8	7.8	14.4	14.4	16.6	16.6	29.5	29.5	29.5	34.9
	240V [kVA]	9.0	9.0	9.0	9.0	16.6	16.6	19.1	19.1	34.1	34.1	34.1	40.3
	480V [kVA]	18.1	18.1	18.1	18.1	33.3	33.3	38.2	38.2	68.2	68.2	68.2	80.6
	600V [kVA]	22.6	22.6	22.6	22.6	41.6	41.6	47.8	47.8	85.2	85.2	85.2	100.8
	660V [kVA]	24.9	24.9	24.9	24.9	45.7	45.7	52.6	52.6	93.7	93.7	93.7	110.9

		100/104-C, 100S/104S-C															
		09	12	16	23	30	37	40*200	40*400	43	55	60	72	85	90*200	90*400	97
Coil Type:	Conventional	X	X	X	X	X	X	X	X	X	X	X	X	X	X	X	X
	Electronic — EI	X	X	X	X	X	X	X	X	X	X	—	—	—	—	—	—

<b>Switching of 3-phase Capacitors, AC-6b (50 Hz)<sup>(1)</sup></b>																	
Single capacitor 40°C	230V [kVar]	8	8	8.5	9	14	14	—	—	24	24	28	28	28	—	—	28
	240V [kVar]	8	8	8.5	9	14	14	—	—	25	25	29	29	29	—	—	29
	400V [kVar]	8	8	10	12.5	20	24	—	—	35	35	48	48	48	—	—	48
	415V [kVar]	8	8	10	12.5	20	25	—	—	35	35	50	50	50	—	—	50
	500V [kVar]	8	8	10	12.5	20	25	—	—	35	35	50	55	60	—	—	60
	690V [kVar]	8	8	10	12.5	20	25	—	—	35	35	50	55	60	—	—	60
Single capacitor 60 °C	230V [kVar]	8	8	8.5	9	12.5	12.5	—	—	18	18	28	28	28	—	—	28
	240V [kVar]	8	8	8.5	9	12.5	12.5	—	—	18	18	29	29	29	—	—	29
	400V [kVar]	8	8	10	12.5	20	21.5	—	—	30	30	42	48	48	—	—	48
	415V [kVar]	8	8	10	12.5	20	22	—	—	30	30	42	50	50	—	—	50
	500V [kVar]	8	8	10	12.5	20	25	—	—	30	30	42	50	55	—	—	55
	690V [kVar]	8	8	10	12.5	20	25	—	—	30	30	42	50	55	—	—	55
Group capacitors 40°C	230V [kVar]	5	5	8	9	12.5	14	—	—	20	20	28	28	28	—	—	28
	240V [kVar]	5	5	8	9	12.5	14	—	—	20	20	29	29	29	—	—	29
	400V [kVar]	5	5	8	10	15	20	—	—	25	25	40	48	48	—	—	48
	415V [kVar]	5	5	8	10	15	20	—	—	25	25	40	50	50	—	—	50
	500V [kVar]	5	5	8	10	15	20	—	—	25	25	40	50	50	—	—	50
	690V [kVar]	5	5	8	10	15	20	—	—	25	25	40	50	50	—	—	50
Group capacitors 60 °C	230V [kVar]	5	5	8	9	12.5	12.5	—	—	18	18	28	28	28	—	—	28
	240V [kVar]	5	5	8	9	12.5	12.5	—	—	18	18	29	29	29	—	—	29
	400V [kVar]	5	5	8	10	15	20	—	—	25	25	40	48	48	—	—	48
	415V [kVar]	5	5	8	10	15	20	—	—	25	25	40	50	50	—	—	50
	500V [kVar]	5	5	8	10	15	20	—	—	25	25	40	50	50	—	—	50
	690V [kVar]	5	5	8	10	15	20	—	—	25	25	40	50	50	—	—	50
60 Hz Single Capacitor — 40 °C	200V [kVar]	5	5	8	9	12.5	14	—	—	20	20	28	28	28	—	—	28
	230V [kVar]	5	5	8	9	12.5	14	—	—	20	20	29	29	29	—	—	29
	460V [kVar]	5	5	8	10	15	20	—	—	25	25	40	50	50	—	—	50
	600V [kVar]	5	5	8	10	15	20	—	—	25	25	40	50	50	—	—	50
60 Hz Group Capacitors — 40 °C	200V [kVar]	5	5	8	9	12.5	12.5	—	—	18	18	28	28	28	—	—	28
	230V [kVar]	5	5	8	9	12.5	12.5	—	—	18	18	29	29	29	—	—	29
	460V [kVar]	5	5	8	10	15	20	—	—	25	25	40	50	50	—	—	50
	600V [kVar]	5	5	8	10	15	20	—	—	25	25	40	50	50	—	—	50

(1) Inductance of leads between capacitors in parallel: min. 6 μH (100-C09...C30 contactors: min 30 μH)

		100/104-C, 100S/104S-C																
		09	12	16	23	30	37	40*200	40*400	43	55	60	72	85	90*200	90*400	97	
Coil Type:	Conventional	X	X	X	X	X	X	X	X	X	X	X	X	X	X	X	X	
	Electronic — EI	X	X	X	X	X	X	X	X	X	X	—	—	—	—	—	—	
<b>Switching of Lamps</b>																		
Gas discharge lamps AC-5a, 40 °C																		
open	[A]	22.5	25	28	29	40.5	45	65	65	77	77	81	85	90	115	115	115	
enclosed	[A]	22.5	25	28	29	37	41	54	54	57	57	77	81	90	95	95	100	
Individually compensated:																		
Max. capacitance at expected																		
Short-circuit current of	10 kA	[μF]	1000	1000	1000	1000	2700	2700	—	—	3200	3200	4000	4000	4700	—	—	4700
	20 kA	[μF]	500	500	500	500	1350	1350	—	—	1600	1600	2000	2000	2350	—	—	2350
	50 kA	[μF]	200	200	200	200	540	540	—	—	640	640	800	800	940	—	—	940
Filament AC-5b	230/240V	[A]	12	16	18	22	30	37	18	25	43	51	60	70	76	60	75	90
<b>Switching of Low Inductive Loads in Home Appliances and Similar Applications per IEC 61095 (50 Hz)</b>																		
AC-7a	230V	[A]	32	32	32	32	45	45	—	—	63	63	—	—	—	—	—	—
	400V	[A]	32	32	32	32	45	45	—	—	63	63	—	—	—	—	—	—
	440V	[A]	32	32	32	32	45	45	—	—	63	63	—	—	—	—	—	—
<b>Switching of Motor Load for Home Appliances (50 Hz)</b>																		
AC-7b	230V	[A]	10.5	14	19	23	30	—	—	—	—	—	—	—	—	—	—	—
	400V	[A]	9	12	16	20	30	—	—	—	—	—	—	—	—	—	—	—
	440V	[A]	7.5	10	13.5	18	27	—	—	—	—	—	—	—	—	—	—	—
<b>Switching of Hermetically Sealed Cooling Compressor Motors - manual reset of overload release (50 Hz)</b>																		
AC-8a	400V	[A]	12	16	22	32	38	45	—	—	63	63	72	85	100	—	—	115
	500V	[A]	12	16	22	32	38	45	—	—	63	63	72	85	100	—	—	115
	690V	[A]	8	10	14	20	28	35	—	—	42	42	56	67	80	—	—	90
- automatic reset of overload release																		
AC-8b	400V	[A]	5.5	7	9.3	12	13	14	—	—	16	16	24	30	35	—	—	35
	500V	[A]	5.5	7	9.3	12	13	14	—	—	16	16	24	30	35	—	—	35
	690V	[A]	5.5	7	9.3	12	13	14	—	—	16	16	24	30	35	—	—	35
<b>Switching of DC Loads</b>																		
Non-inductive or slightly inductive loads or resistance furnaces DC-1, 60 °C																		
1 pole	24V	[A]	25	25	32	32	45	45	45	45	50	50	70	80	80	80	80	80
	48/60V	[A]	20	20	20	20	25	25	25	25	30	30	40	40	40	40	40	40
	110V	[A]	6	6	6	6	8	8	10	10	9	9	11	11	11	11	11	11
	220V	[A]	1.5	1.5	1.5	1.5	1.5	1.5	1.5	1.5	1.5	1.5	2	2	2	1.8	1.8	2
	440V	[A]	0.4	0.4	0.4	0.4	0.4	0.4	0.4	0.4	0.5	0.5	0.5	0.5	0.5	0.5	0.5	0.5
2 poles in series	24V	[A]	25	25	32	32	45	45	45	45	50	50	70	80	80	80	80	80
	48/60V	[A]	25	25	32	32	45	45	45	45	50	50	70	80	80	80	80	80
	110V	[A]	25	25	32	32	45	45	45	45	50	50	70	80	80	80	80	80
	220V	[A]	8	8	8	10	10	10	10	10	10	10	15	15	15	15	15	15
	440V	[A]	1	1	1	1	1	1	1	1	1	1	1.5	1.5	1.5	1.5	1.5	1.5
3 poles in series	24V	[A]	25	25	32	32	45	45	—	—	63	63	90	90	100	—	100	100
	48/60V	[A]	25	25	32	32	45	45	—	—	50	50	70	90	100	—	100	100
	110V	[A]	20	20	25	25	30	30	—	—	35	35	70	90	100	—	100	100
	220V	[A]	6	6	6	10	15	15	—	—	20	20	25	80	80	—	80	80
	440V	[A]	0.6	0.6	0.6	0.6	0.6	0.6	—	—	0.6	0.6	0.6	5	5	—	5	5

		100/104-C, 100S/104S-C															
		09	12	16	23	30	37	40*200	40*400	43	55	60	72	85	90*200	90*400	97
Coil Type:	Conventional	X	X	X	X	X	X	X	X	X	X	X	X	X	X	X	X
	Electronic — EI	X	X	X	X	X	X	X	X	X	X	X	—	—	—	—	—

Switching of DC Loads, Continued

Shunt-wound Motors, Starting, reverse current braking, reversing, stepping DC-3, 60 °C

3 poles in series	24V	[A]	25	25	32	32	45	45	—	—	63	63	90	90	100	—	—	100
	48/60V	[A]	25	25	32	32	45	45	—	—	50	50	70	70	80	—	—	80
	110V	[A]	20	20	25	25	30	30	—	—	35	35	70	70	80	—	—	80
	220V	[A]	6	6	6	10	15	15	—	—	20	20	25	25	30	—	—	30
	440V	[A]	0.6	0.6	0.6	0.6	0.6	0.6	—	—	0.6	0.6	0.6	0.6	0.6	—	—	0.6

Series-wound Motors, Starting, reverse current braking, reversing, stepping DC-5, 60 °C

3 poles in series	24V	[A]	25	25	32	32	45	45	—	—	63	63	90	90	100	—	—	100
	48/60V	[A]	25	25	32	32	45	45	—	—	50	50	70	70	80	—	—	80
	110V	[A]	20	20	25	25	30	30	—	—	35	35	70	70	80	—	—	80
	220V	[A]	6	6	6	10	15	15	—	—	20	20	25	25	30	—	—	30
	440V	[A]	0.6	0.6	0.6	0.6	0.6	0.6	—	—	0.6	0.6	0.6	0.6	0.6	—	—	0.6

Short Time Withstand  
I<sub>CW</sub>, 60 °C

10 s	[A]	170	170	170	215	300	304	304	304	375	375	700	700	700	700	700	840
------	-----	-----	-----	-----	-----	-----	-----	-----	-----	-----	-----	-----	-----	-----	-----	-----	-----

Resistance and Power Dissipation







Main current circuit resistance	[mΩ]	2.7	2.7	2.7	2	2	2	2	1.5	1.5	1	0.9	0.9	0.9	0.8	0.7	0.6	
Power dissipation by all circuits at I <sub>e</sub> AC-3/400V	[W]	0.66	1.2	2.1	3.2	5.4	8.2	11.3	8.4	8.3	9.1	9.7	14	19.5	11.6	20.2	17	
Total power dissipation At I <sub>e</sub> AC-3/400V	AC control	[W]	3.4	3.9	4.8	6.3	8.5	11.3	8.8	9.5	11.6	12.4	14.2	18.5	24	20.6	29.2	26
	DC control (conv.)	[W]	—	—	—	—	—	—	—	—	—	—	13.7	18	23.5	16.6	25.2	22
	DC control (elect.)	[W]	2.4	2.9	3.8	4.9	7.1	9.9	8	8.7	10.8	11.6	—	—	—	—	—	—

Lifespan

Mechanical AC control	[Million ops.]	13	13	13	13	13	13	10	10	12	12	6	6	6	6	6	6
Mechanical DC control	[Million ops.]	13	13	13	13	13	13	10	10	13	13	6	6	6	6	6	6
Electrical AC-3 (400 V)	[Million ops.]	1.3	1.3	1.3	1.3	1.3	1.3	—	—	1	0.8	1	1	1	—	—	1

Weight

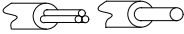
AC	Non-Rev.	[kg (lbs)]	0.39 (0.86)	0.39 (0.86)	0.39 (0.86)	0.39 (0.86)	0.48 (1.06)	0.49 (1.08)	0.63 (1.39)	0.63 (1.39)	0.51 (1.12)	0.51 (1.12)	1.45 (3.20)	1.45 (3.20)	1.45 (3.20)	—	—	1.45 (3.20)
	Rev.	[kg (lbs)]	0.85 (1.89)	0.85 (1.89)	0.85 (1.89)	0.85 (1.89)	1.08 (2.39)	1.08 (2.39)	—	—	1.15 (2.54)	1.15 (2.54)	3.14 (6.92)	3.14 (6.92)	3.14 (6.92)	—	—	3.14 (6.92)
DC	Non-Rev.	[kg (lbs)]	0.6 (1.32)	—	—	—	—	—	—	—	—	—	1.47 (3.24)	1.47 (3.24)	1.47 (3.24)	—	—	1.47 (3.24)
	Rev.	[kg (lbs)]	1.27 (2.81)	—	—	—	—	—	—	—	—	—	3.22 (7.1)	3.22 (7.1)	3.22 (7.1)	—	—	3.22 (7.1)
DC (Electronic-EQ, EJ)	Non-Rev.	[kg (lbs)]	—	0.40 (0.88)	0.40 (0.88)	0.40(0.88)	0.40 (0.88)	0.49 (1.08)	0.49 (1.08)	0.57 (1.25)	0.57 (1.25)	0.57 (1.25)	0.57 (1.25)	—	—	—	—	—
	Rev.	[kg (lbs)]	—	0.87 (1.91)	0.87 (1.91)	0.87(1.91)	0.87 (1.91)	1.08 (2.39)	1.08 (2.39)	—	—	1.27 (2.79)	1.27 (2.79)	—	—	—	—	—
DC (Electronic- EW, EY, ED, EA)	Non-Rev.	[kg (lbs)]	—	0.43 (0.95)	0.43 (0.95)	0.43(0.95)	0.43 (0.95)	0.52 (1.14)	0.52 (1.14)	0.60 (1.32)	0.60 (1.32)	0.60 (1.32)	0.60 (1.32)	—	—	—	—	—
	Rev.	[kg (lbs)]	—	0.93 (2.05)	0.93 (2.05)	0.93(2.05)	0.93 (2.05)	1.14 (2.51)	1.14 (2.51)	—	—	1.33 (2.93)	1.33 (2.93)	—	—	—	—	—

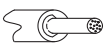
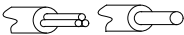
			100/104-C, 100S/104S-C													
			09	12	16	23	30	37	40	43	55	60	72	85	90	97
Coil Type:	Conventional		X	X	X	X	X	X	X	X	X	X	X	X	X	
	Electronic — EI		X	X	X	X	X	X	X	X	X	—	—	—	—	
Conductor Cross Sections - Main Contacts Terminal type																
	1 conductor	[mm <sup>2</sup> ]	1...4				2.5...10		2.5...16			2.5...35				
	2 conductors	[mm <sup>2</sup> ]	1...4				2.5...10		2.5...10			2.5...25				
	1 conductor	[mm <sup>2</sup> ]	1.5...6				2.5...16		2.5...25			2.5...50				
	2 conductors	[mm <sup>2</sup> ]	1.5...6				2.5...16		2.5...16			2.5...35				
Recommended torque		[N•m]	1.5...2.0				2.5...3.5		2.5...3.5			4.5...6				
Cross section per UL/CSA		[AWG]	16...10				14...4		14...6	14...4		14...1				
Recommended torque		[lb-in]	13.3...17.7				22...31		22...31			40...53				
Conductor Cross Sections - Coil Terminal type																
	1 conductor	[mm <sup>2</sup> ]							1...2.5							
	2 conductors	[mm <sup>2</sup> ]							1...2.5							
	1 conductor	[mm <sup>2</sup> ]							1...4							
	2 conductors	[mm <sup>2</sup> ]							1...4							
Recommended torque		[N•m]							1...1.5							
Cross section per UL/CSA		[AWG]							16...12							
Recommended torque		[lb-in]							9...13							

- (1) Pozidriv No. 2 / Blade No. 3 screw
- (2) Pozidriv No. 2 / Blade No. 4 screw
- (3) Hexagonal socket screw

## Short-Circuit Coordination Data

See <http://www.rockwellautomation.com/global/support/global-sccr.page?> for complete short-circuit current ratings.

		100/104-C, 100S/104S-C																
		09	12	16	23	30	37	40*200	40*400	43	55	60	72	85	90*200	90*400	97	
Coil Type:	Conventional	X	X	X	X	X	X	X	X	X	X	X	X	X	X	X	X	
	Electronic - EI	X	X	X	X	X	X	X	X	X	X	—	—	—	—	—	—	
<b>Short Circuit Coordination (Max. Fuse or Circuit Breaker Rating) Per IEC 60947-4-1 (contactor and fuses only)</b>																		
DIN Fuses- gG, gL	Type"1"(690V)	[A]	50 kA Available Fault Current															
	Type"2"(400V)	[A]	50	50	50	80	125	125	160	160	160	160	250	250	250	250	250	250
	Type"2"(690V)	[A]	25	35	35	40	80	80	63	80	100	100	160	160	160	160	100	200
BS88Fuses	Type"1"(415V)	[A]	65kA Available Fault Current															
	Type"2"(415V)	[A]	25	32	40	50	63	80	—	—	80	TBD	100	160	160	—	—	TBD
	Type"2"(415V)	[A]	20	25	32	50	63	80	—	—	80	TBD	100	125	160	—	—	TBD
<b>Per UL 508 and CSA 22.2 No. 14 (contactor and fuses or circuit breaker only)</b>																		
UL Class K5 and RK5 Fuses	UL Listed Combination (600V)	[A]	5 kA Available Fault Current															
		[A]	35	40	70	90	110	125	125	125	150	200	200	—	—	—	—	—
UL Class CC and CSA HRCI-MISC Fuses	UL verified combination to IEC60947-4-1 "Type2"	[A]	10 kA Available Fault Current															
		[A]	—	—	—	—	—	—	—	—	—	—	—	250	300	300	300	350
UL Class J and CSA HRCI-J Fuses	UL verified combination to IEC60947-4-1 "Type2"	[A]	100 kA Available Fault Current															
		[A]	20 <sup>(1)</sup>	20	30	40	—	—	—	—	—	—	—	—	—	—	—	—
UL Inverse-Time Circuit Breaker	UL Listed Combination (480V)	[A]	5 kA Available Fault Current															
		[A]	30	30	50	50	125	125	—	—	125	150	250	—	—	—	—	—
	UL Listed Combination (600V)	[A]	10 kA Available Fault Current															
		[A]	—	—	—	—	—	—	—	—	—	—	—	250	250	—	—	250
	UL Listed Combination (600Y/347V)	[A]	18 kA Available Fault Current															
		[A]	—	—	—	—	—	—	—	—	—	—	—	—	—	—	—	—
	UL Listed Combination (600V)	[A]	25 kA Available Fault Current															
		[A]	30 <sup>(2)</sup>	30 <sup>(2)</sup>	30 <sup>(2)</sup>	30 <sup>(2)</sup>	50 <sup>(3)</sup>	50 <sup>(3)</sup>	—	—	50 <sup>(3)</sup>	—	110	110	110	—	—	—
	UL Listed Combination (480V)	[A]	50 kA Available Fault Current															
		[A]	—	—	—	—	50 <sup>(3)</sup>	50 <sup>(3)</sup>	—	—	50 <sup>(3)</sup>	—	—	—	—	—	—	—
UL Listed Combination (480Y/277V)	[A]	65 kA Available Fault Current																
	[A]	30 <sup>(2)</sup>	30 <sup>(2)</sup>	30 <sup>(2)</sup>	30 <sup>(2)</sup>	—	—	—	—	—	—	—	—	—	—	—	—	
UL Listed Combination (480V)	[A]	50 kA Available Fault Current																
	[A]	—	—	—	—	100 <sup>(4)</sup>	100 <sup>(4)</sup>	—	—	100 <sup>(4)</sup>	125	200 <sup>(4)</sup>	225 <sup>(4)</sup>	225 <sup>(4)</sup>	—	—	225 <sup>(4)</sup>	



- (1) 15 A max. fuse for Type 2 coordination.
- (2) Ratings apply when used with Bulletin 140U-D circuit breakers only.
- (3) Minimum enclosure size 12-3/8 x 7-5/8 s 7-1/4 inches
- (4) Minimum enclosure size 20 x 12 x 8 inches with two latches.

### Coil Data

		100/104-C, 100S/104S-C															
		09	12	16	23	30	37	40*200	40*400	43	55	60	72	85	90*200	90*400	97
Coil Type:	Conventional	X	X	X	X	X	X	X	X	X	X	X	X	X	X	X	X
	Electronic - EI	X	X	X	X	X	X	X	X	X	X	—	—	—	—	—	—
Operating Limits																	
50 Hz, 60 Hz, 50/60 Hz	pick-up	[x U <sub>s</sub> ]	0.85...1.1					0.85...1.1					0.85...1.1				
	dropout	[x U <sub>s</sub> ]	0.3...0.6					0.3...0.6					0.3...0.6				
DC (conventional)	pick-up	[x U <sub>s</sub> ]	—					—					0.8...1.1				
	dropout	[x U <sub>s</sub> ]	—					—					0.1...0.6				
DC (electronic—EQ, EJ, EW, QJ)	pick-up	[x U <sub>s</sub> ]	0.7...1.25					—					—				
	dropout	[x U <sub>s</sub> ]	0.3...0.4					—					—				
DC (electronic—EY)	pick-up	[x U <sub>s</sub> ]	0.8...1.25					—					—				
	dropout	[x U <sub>s</sub> ]	0.3...0.4					—					—				
DC (electronic—ED)	pick-up	[x U <sub>s</sub> ]	0.7...1.12 <sup>(1)</sup>					—					—				
	dropout	[x U <sub>s</sub> ]	0.3...0.4					—					—				
DC (electronic—EA)	pick-up	[x U <sub>s</sub> ]	0.8...1.1					—					—				
	dropout	[x U <sub>s</sub> ]	0.3...0.4					—					—				
Coil Consumption																	
50 Hz, 60 Hz, 50/60 Hz	pick-up	[VA]	75			105			135			235			400		
	hold-in	[VA/W]	9.5/2.7			12.3/3.1			13.3/3.3			19.6/5			24/9		
DC (conventional)	pick-up	[W]	—			—			—			200			325		
	hold-in	[W]	—			—			—			4			5		
DC (electronic—EQ, EJ, QJ)	pick-up (avg/peak)	[W]	10/17			16/25			—			—					
	hold-in	[W]	1.7			2.5			—			—					
DC (electronic—EY, EW)	pick-up (avg/peak)	[W]	10/17			16/25			—			—					
	hold-in	[W]	1.9			2.7			—			—					
DC (electronic—ED)	pick-up (avg/peak)	[W]	12/19			16/26			—			—					
	hold-in	[W]	2.1			2.8			—			—					
DC (electronic—EA)	pick-up (avg/peak)	[W]	14/22			18/29			—			—					
	hold-in	[W]	3.0			4.0			—			—					
Operating Times																	
AC	closing delay	[ms]	15...30		15...30		15...30		15...30		20...40		20...40				
	opening delay	[ms]	10...60		10...60		10...60		10...60		10...60		20...40				
With RC module	closing delay	[ms]	10...60		10...60		10...60		10...60		10...60		20...40				
DC (conventional)	opening delay	[ms]	—		—		—		—		50...80		20...40				
	closing delay	[ms]	—		—		—		—		7...15		—				
With integrated diode	opening delay	[ms]	—		—		—		—		17...23		≤ 220V 20...35				
With external diode	opening delay	[ms]	—		—		—		—		80...125		—				
DC (electronic—EQ, EJ)	closing delay	[ms]	20...50					—					—				
	opening delay	[ms]	20...50					—					—				
	Max. Ripple		±15%					—					—				
	min. OFF time	[ms]	50					—					—				
DC (electronic—EW, EY, ED, EA)	closing delay	[ms]	20...50					—					—				
	opening delay	[ms]	23...33					—					—				
	Max. Ripple		±15%					—					—				
	min. OFF time	[ms]	50					—					—				
DC (electronic—QJ)	closing delay	[ms]	20...50					—					—				
	opening delay	[ms]	16...21					—					—				
	Max. Ripple		±15%					—					—				
	min. OFF time	[ms]	50					—					—				

(1) 0.7...1.25 at 110V DC

## Auxiliary Contacts, Auxiliary Contact Blocks, and Pneumatic Timers

			Internal	Front mounted	Front mounted (Bifurcated)	Side-mounted
<b>Switching of AC Loads</b>						
AC-12 $I_{th}$	at 40 °C	[A]	20	10	10	10
	at 60 °C	[A]	20	6	6	6
AC-15 at rated voltage of	24V	[A]	10	6	3	6
	42/48V	[A]	10	6	3	6
	120V	[A]	10	6	3	6
	230V	[A]	10	5.5	3	5.5
	240V	[A]	10	5	3	5
	400V	[A]	6	3	2	3
	415V	[A]	6	3	2	3
	500V	[A]	2.5	1.6	1.2	1.6
	690V	[A]	1	1	0.7	1
<b>Switching of DC Loads</b>						
DC-12 L/R < 1 ms resistive loads at	24V DC	[A]	12	12	6	6
	48V DC	[A]	9	9	3.2	3.2
	110V DC	[A]	3.5	3.5	1	1
	220V DC	[A]	0.55	0.55	0.5	0.5
	440V DC	[A]	0.2	0.2	0.2	0.2
DC-14L/R <15 ms inductive loads with economy resistor in series at	24V DC	[A]	9	9	2	2
	48V DC	[A]	5	5	1.6	1.6
	110V DC	[A]	2	2	0.3	0.3
	220V DC	[A]	0.4	0.4	0.12	0.12
	440V DC	[A]	0.16	0.16	0.05	0.05
DC-13 switching electromagnets at	24V DC	[A]	5	5	2.5	5
	48V DC	[A]	3	3	1.5	2.5
	110V DC	[A]	1.2	1.2	0.6	0.68
	220V DC	[A]	0.6	0.6	0.3	0.32
	440V DC	[A]	0.3	0.15	0.15	0.15
<b>Fuse gG</b>						
Short-circuit protection with no welding of contacts per IEC 60947-5-1		[A]	20	10	10	10
		[A]	20	10	10	10
Protective Separation per IEC 60947-1, Annex N			between load and auxiliary circuit 320V	between load and auxiliary circuit 440V		
Min. switching capacity according to IEC 60947-5-4			17V/10mA	17V/5mA	5V/3mA	17V/10mA
<b>Load Carrying Capacity per UL/CSA</b>						
Rated voltage	AC	[V]	max.600			
Continuous rating	40 °C	[A]	10	10	10	10
Switching capacity	AC	[A]	A600			
Rated voltage	DC	[V]	max.600			
Switching capacity	DC	[A]	P600	Q600	Q600	



## General

Attribute		Value
<b>Rated Isolation Voltage <math>U_i</math></b>		
IEC	[V]	690
UL, CSA	[V]	600
Rated Impulse Voltage Withstand $U_{imp}$	[kV]	6
<b>Rated Voltage <math>U_e</math></b>		
AC 50/60 Hz	[V]	115, 200, 230, 240, 400, 415, 460, 500, 575, 690
DC	[V]	24, 48, 110, 220, 440
Insulation Class of the Coil		Class F per IEC 60085, UL Class 105
Rated coil frequency		AC 50/60Hz, DC
Ambient Temperature		
Storage	[°C]	-55...+80
Operation at rated voltage	[°C]	-25...+60
at 70 °C		15% current reduction against 60 °C values
Climatic Withstand		IEC 60068-2-1/-2/-30
Max. Altitude of Installation Site	[m]	2000 NN, per IEC60947-1
Protection Class		100-C09...C23: IP2X from all directions 100-C30...C55: IP2X from front with front (upper) terminal wired 100-C60...C97: IP2X from front with front (upper) terminal wired (min. wire size 16 mm <sup>2</sup> or #6 AWG)
Single contactor cover		—
Contactor with frame terminal block		—
Auxiliary contact		IP2X
Protection against Accidental Contact		Finger- and back-of-hand proof per VDE0106, part100
Resistance to Shock		IEC60068-2-27
Resistance to Vibration		IEC60068-2-6
Mechanically Linked Contacts IEC60947-5-1, Annex L		100-/100S-C09...C55+100-FA/-FB/-FC, (except L11, L22), 100-/100S-C09...C55+ 100-FAB/-FBB/-FCB
Mirror Contacts IEC60947-4 Annex F		100-/100S-C09...C97+100-FA/-FB/-FC, (except L11, L22), 100-/100S-C09...C97+ 100-SA/SB, 100-/100S-C09...C97+100-FAB/-FBB/-FCB

## Standards Compliance and Certifications

### 100-C IEC Contactors

Standards Compliance	Certifications
EN/IEC 60947-4-1, 60947-5-1	CE Marked
IEC 60947 Type "2" Coordination	CCC
CSA 22.2. No. 14	cULus Listed (File No. E3125; Guide NLDX, NLDX7)
UL 508	
Meets the material restrictions for European Directive 2002/95/IEC-EU-RoHS	

### 100S-C IEC Safety Contactors

Standards Compliance	Certifications
EN50205	CE Marked
CSA C22.2 No. 14	SUVA Third-Party Certified
UL 508	cULus Listed (File No. E3125; Guide NLDX, NLDX7)
EN/IEC 60947-4	
IEC 60947-4-1 Annex F — Mirror Contacts	
IEC 60947-5-1 Annex L — Mechanically Linked Contacts	
Meets the material restrictions for European Directive 2002/95/IEC-EU-RoHS	

## 100Q-C Capacitor-switching Contactors

Standards Compliance	Certifications
IEC 60947-4	CE Marked
CSA C22.2 No. 14	cULus Listed (File No. E 41850, Guide NLDX, NLDX7)
UL 508	
Meets the material restrictions for European Directive 2002/95/IEC-EU-RoHS	

## Life-Load Curves

Bulletin 100-C/104-C IEC contactors are designed for superior performance in a wide variety of applications. When selecting IEC products, the user must give consideration to the specific load, utilization category, and required electrical life of the application. The life-load curves shown here are based on Rockwell Automation tests according to the requirements defined in IEC 60947-4-1. Since contact life in application is dependent on environmental conditions and duty cycle, actual application contact life may vary from that indicated by the curves shown here.

To find the contactor's estimated electrical life, follow these guidelines:

1. Identify the appropriate utilization category from [Table 1](#).
2. Choose the graph for the utilization category selected.
3. Locate the intersection of the life-load curve for the appropriate contactor with the application's operational current ( $I_e$ ) found on the horizontal axis.
4. Read the estimated contact life along the vertical axis.

### Contact Life for Mixed Utilization Categories AC-3 and AC-4:

In many applications, the utilization category cannot be defined as either purely AC-3 or AC-4. In those applications, the electrical life of the contactor can be estimated from the following equation:

$$L_{\text{mixed}} = L_{\text{ac3}} / [1 + P_{\text{ac4}} * (L_{\text{ac3}} / L_{\text{ac4}} - 1)], \text{ where:}$$

$L_{\text{mixed}}$  = Approximate contact life in operations for a mixed AC-3/AC-4 utilization category application

$L_{\text{ac3}}$  = Approximate contact life in operations for a pure AC-3 utilization category (from the AC-3 life-load curves)

$L_{\text{ac4}}$  = Approximate contact life in operations for a pure AC-4 utilization category (from the AC-4 life-load curves)

$P_{\text{ac4}}$  = Percentage of AC-4 operations

**Table 1 - Utilization Category Determination**

Test Conditions		Making			Breaking		
		$I/I_e$	$U/U_e$	$\cos \phi$	$I_c/I_e$	$U_r/U_e$	$\cos \phi$
AC-1	Resistance Furnaces: Non inductive or slightly inductive loads	1	1	0.95	1	1	0.95
AC-2	Slip-ring motors: Starting and reversing	2.5	1	0.65	2.5	1	0.65
AC-3	Squirrel-cage motors: Starting and stopping of running motors	$I_e < 17\text{ A}$	6	1	0.65	1	0.17
		$I_e > 17\text{ A}$	6	1	0.35	1	0.17
AC-4	Squirrel-cage motors: Starting, plugging <sup>(1)</sup> , inching <sup>(2)</sup>	$I_e < 17\text{ A}$	6	1	0.65	6	1
		$I_e > 17\text{ A}$	6	1	0.35	6	1
AC-15	Solenoids: Contactors, valves and lifting magnets	10	1	0.7	1	1	0.4

- (1) Plugging is understood as stopping or reversing the motor rapidly by reversing motor primary connections while the motor is running.
- (2) Inching (jogging) is understood as energizing a motor once or repeatedly for short periods to obtain small movements of the driven mechanism.

$I_e$  Rated operational current  
 $I$  Making Current  
 $I_c$  Breaking Current  
 $U$  Off-load voltage  
 $U_e$  Rated voltage  
 $U_r$  Recovery voltage

**Figure 5 - AC-1, 40 °C Non- or slightly inductive loads, resistance furnaces;  $U_e = 230...690\text{V}$**

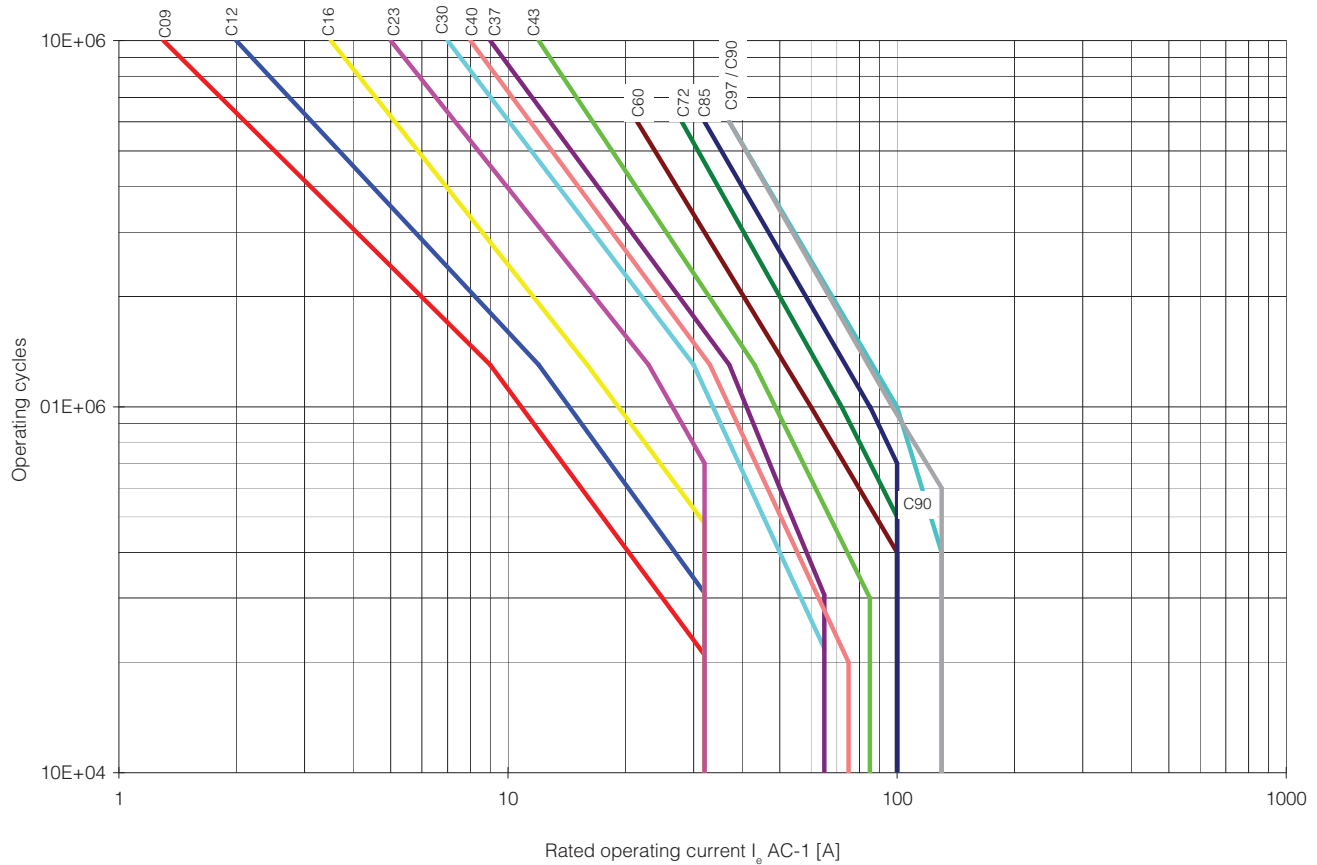

**Figure 6 - AC-2, Switching of slip-ring motors;  $U_e = 230...400...460V$**

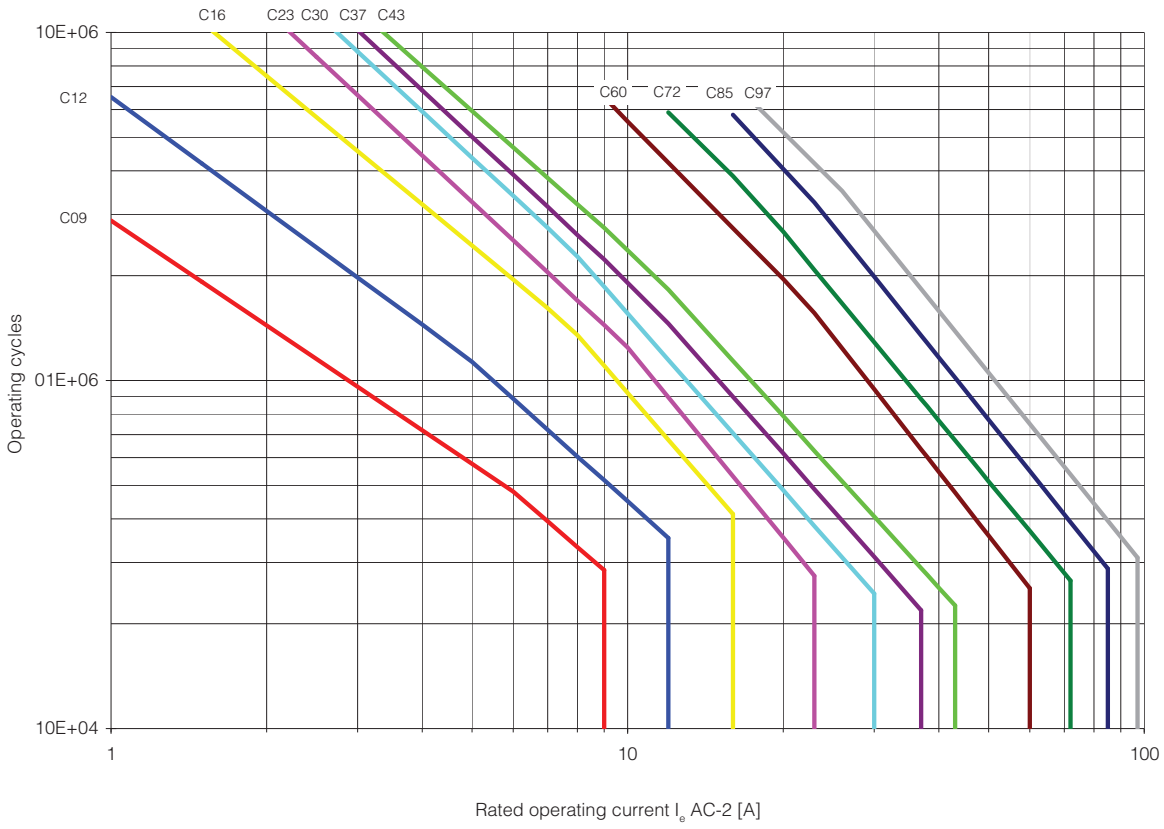

**Figure 7 - AC-3, Switching of squirrel-cage motors while starting;  $U_e = 230...400...460V$**

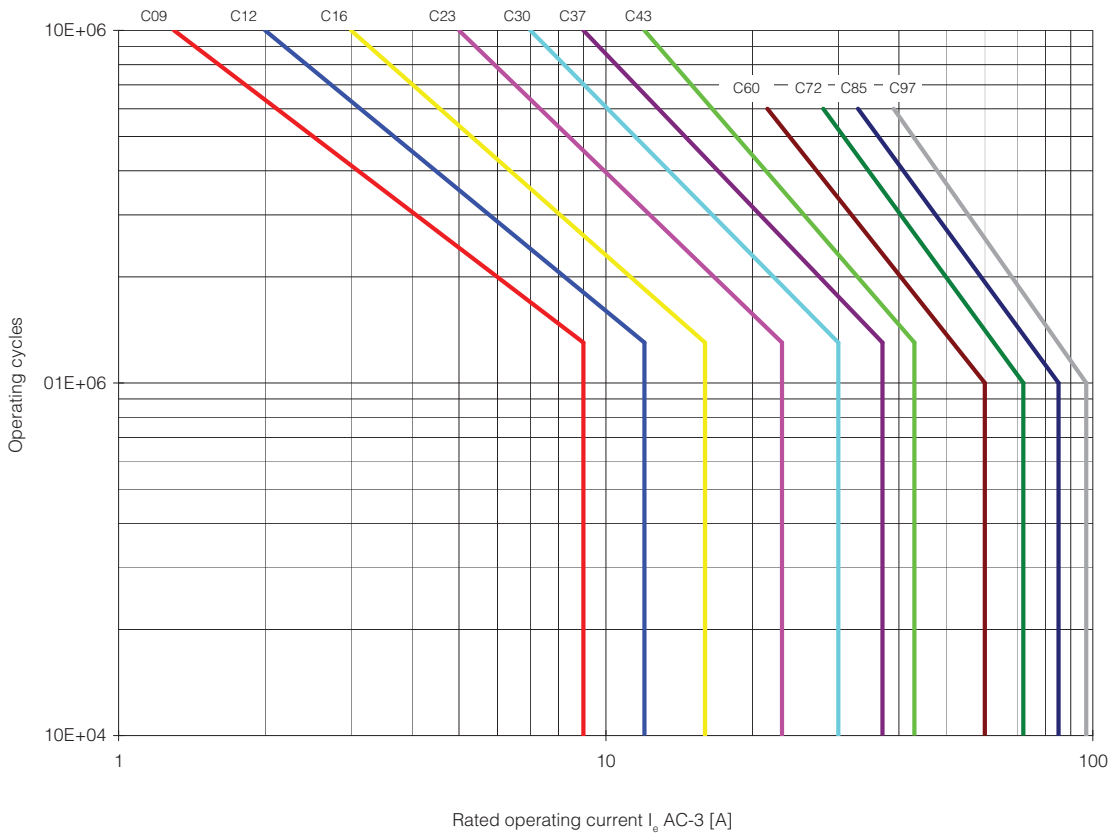

Figure 8 - AC-3, Switching of squirrel-cage motors while starting;  $U_e = 500...575V$

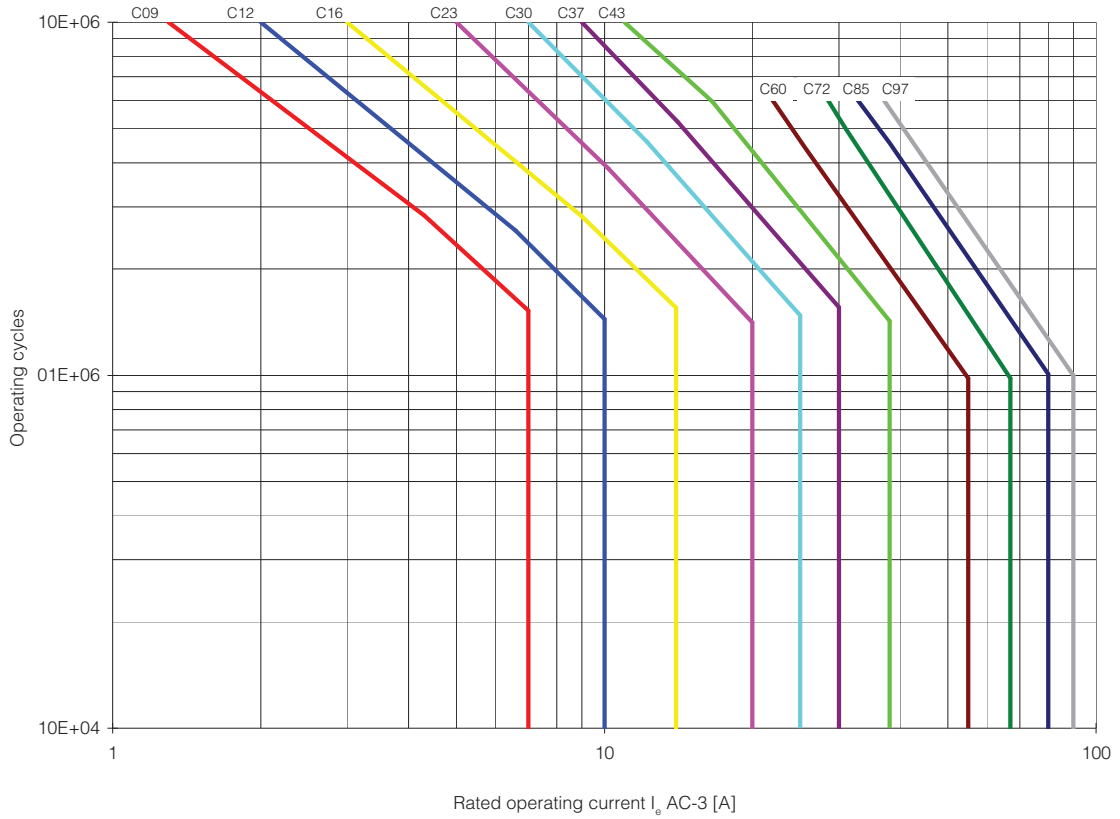

Figure 9 - AC-3, Switching of squirrel-cage motors while starting;  $U_e = 690V$

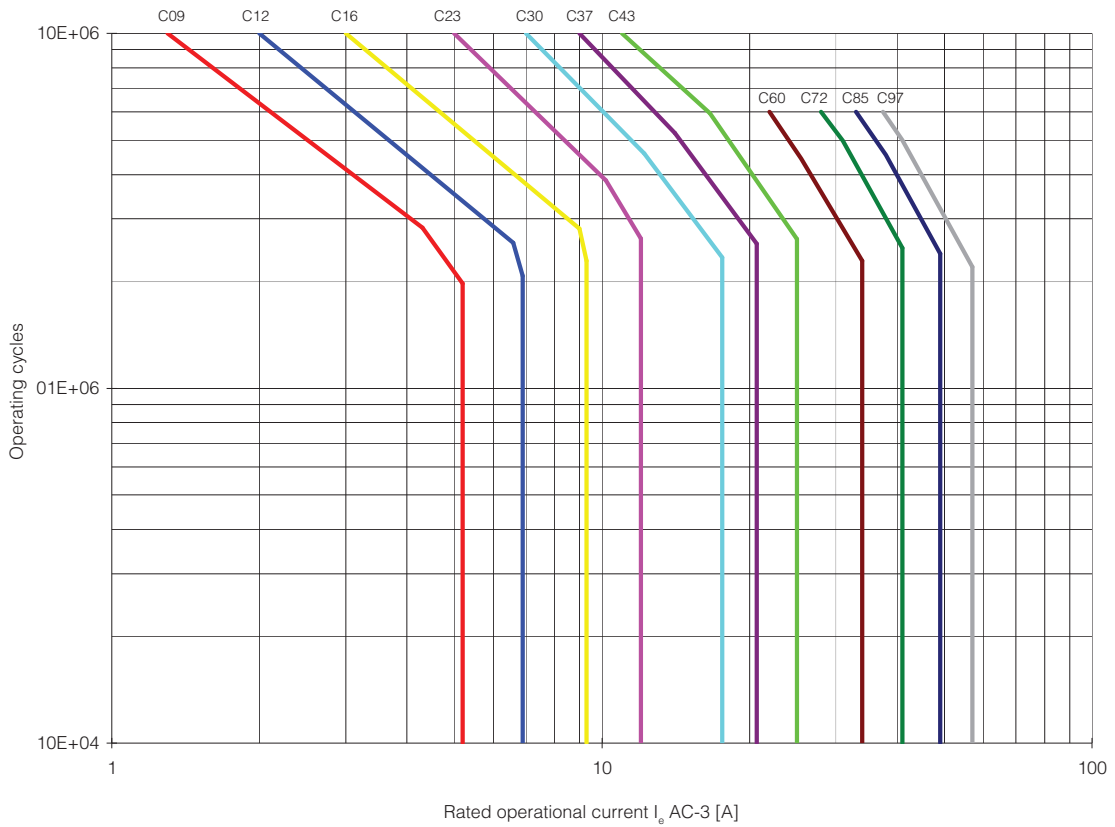

Figure 10 - AC-4, Switching of squirrel-cage motors;  $U_e = 230...690V$

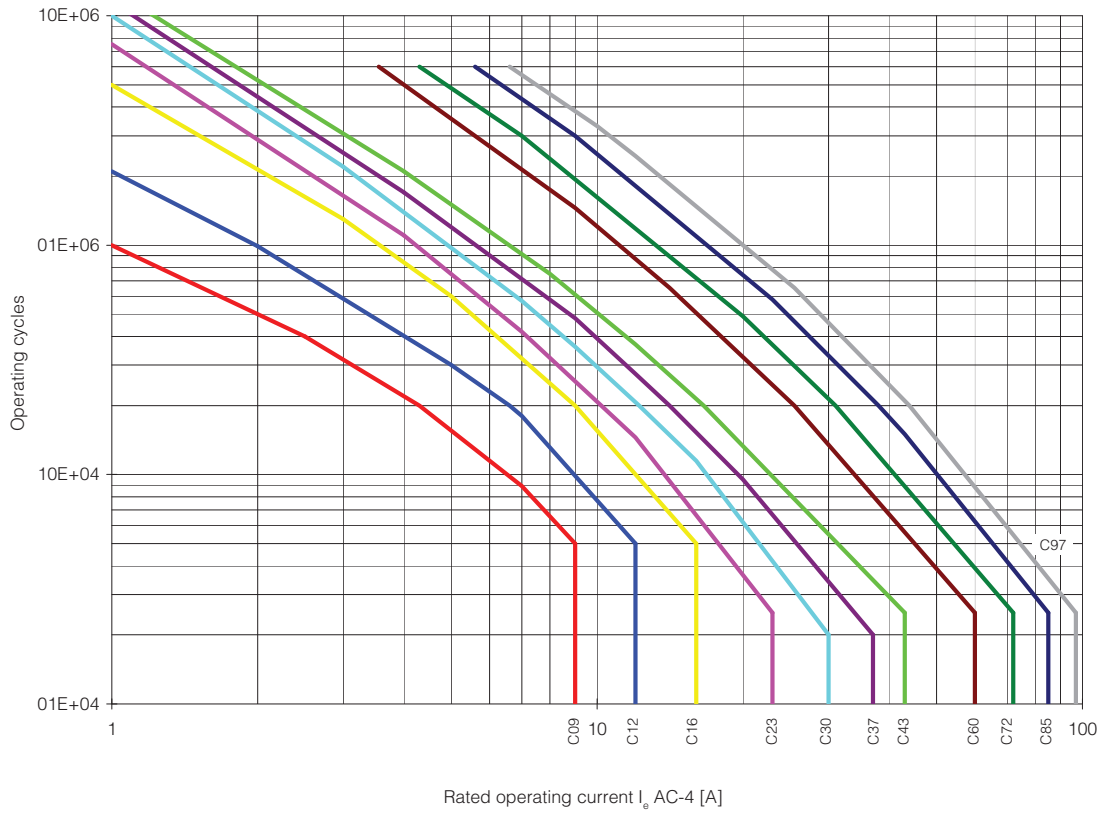

Figure 11 - AC-3 & AC-4, 10% AC-4 Mixed operation of squirrel-cage motors;  $U_e = 230...400...460V$

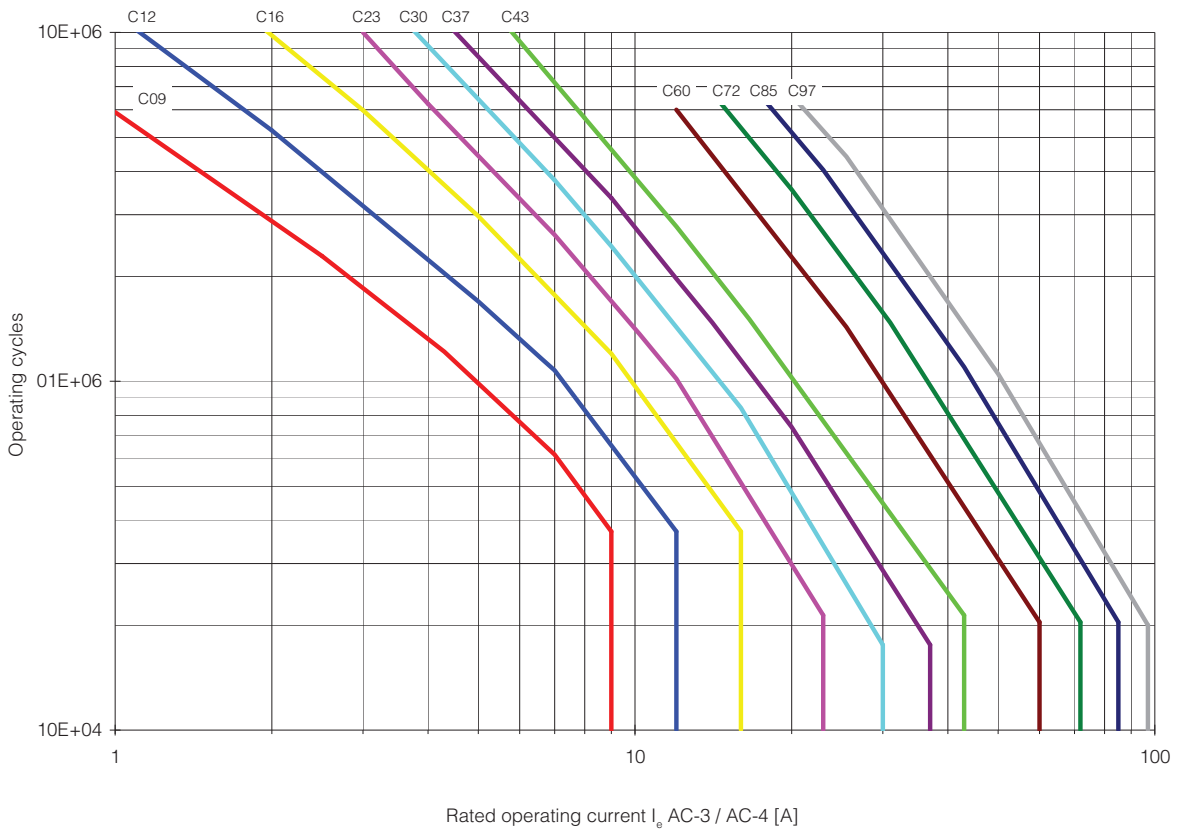
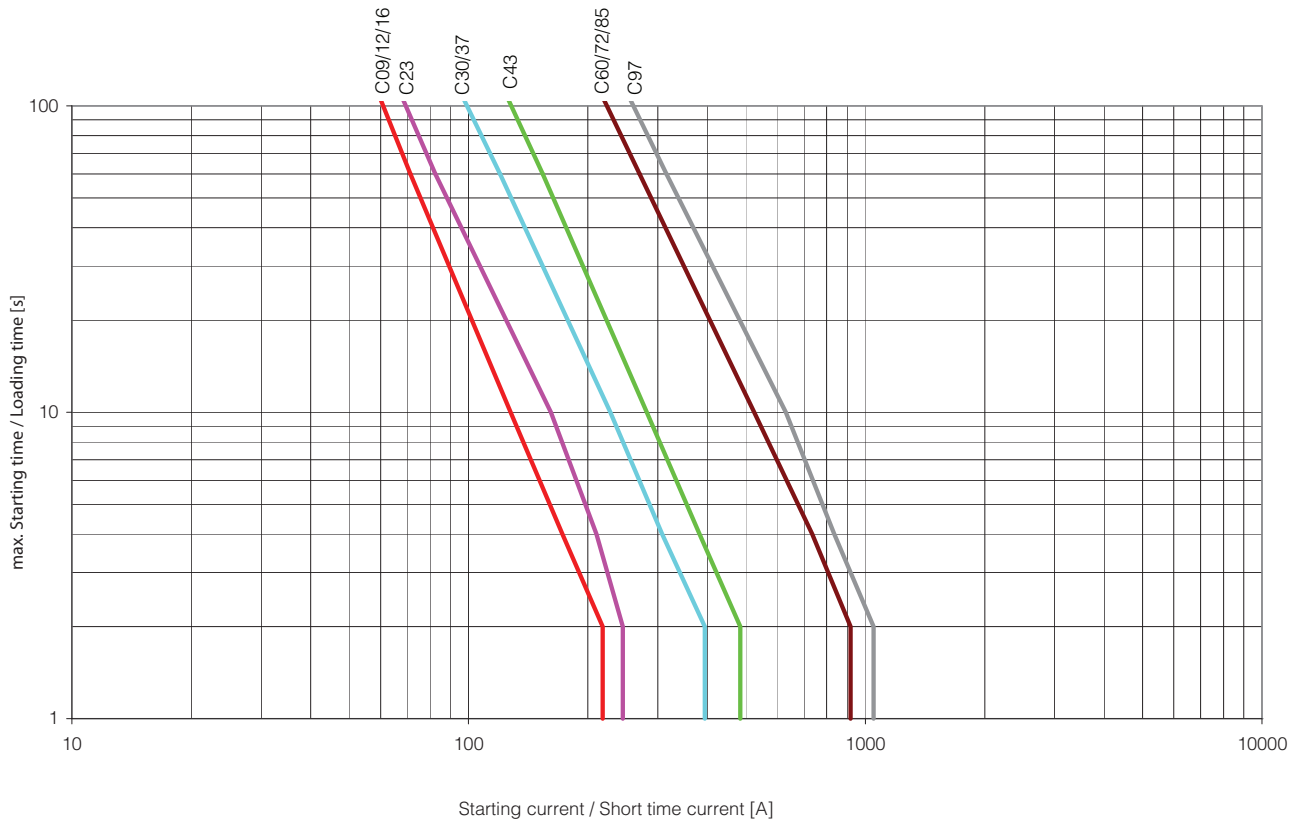

Figure 12 - Heavy Duty Starting and Regular Short-time Operation



# Maximum Operating Rates

Figure 13 - AC-1, 40 °C Non- or slightly inductive loads, resistance furnaces;  $U_e = 230 \dots 690V$

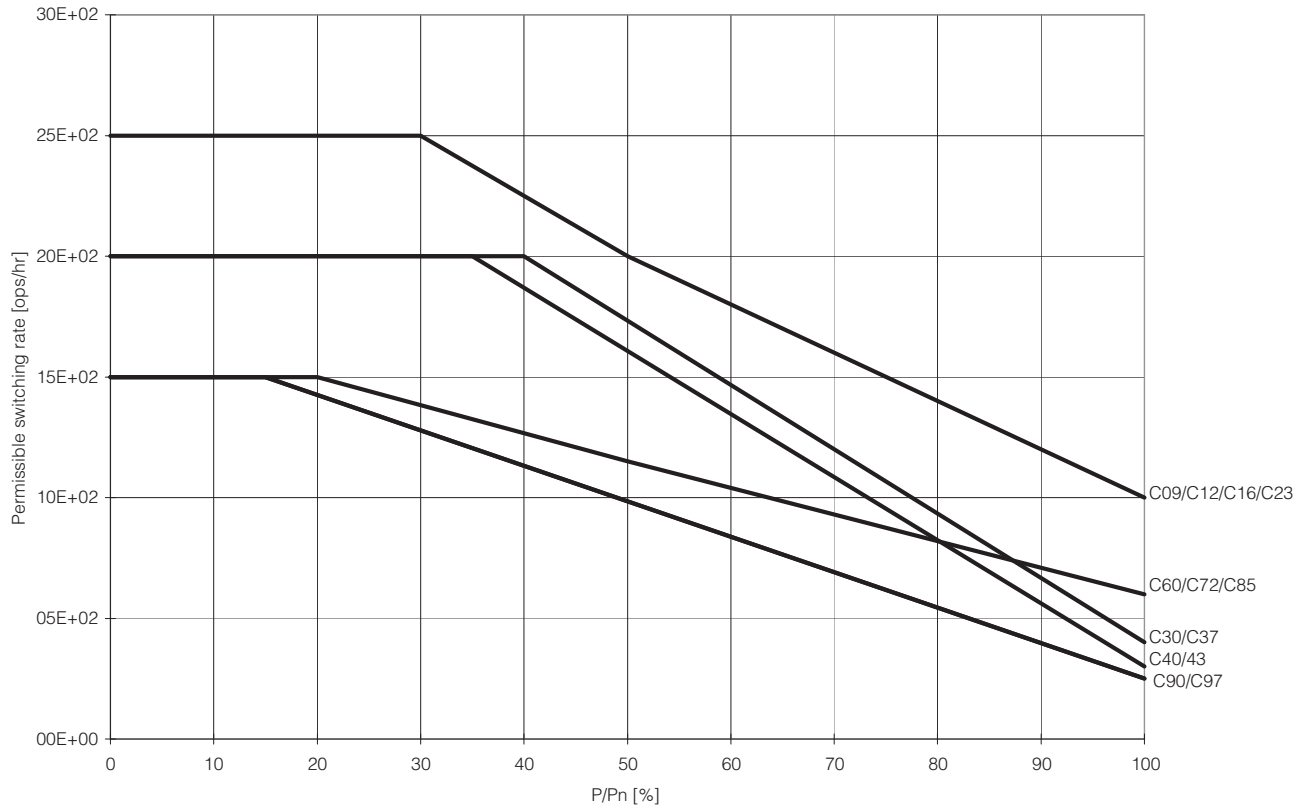
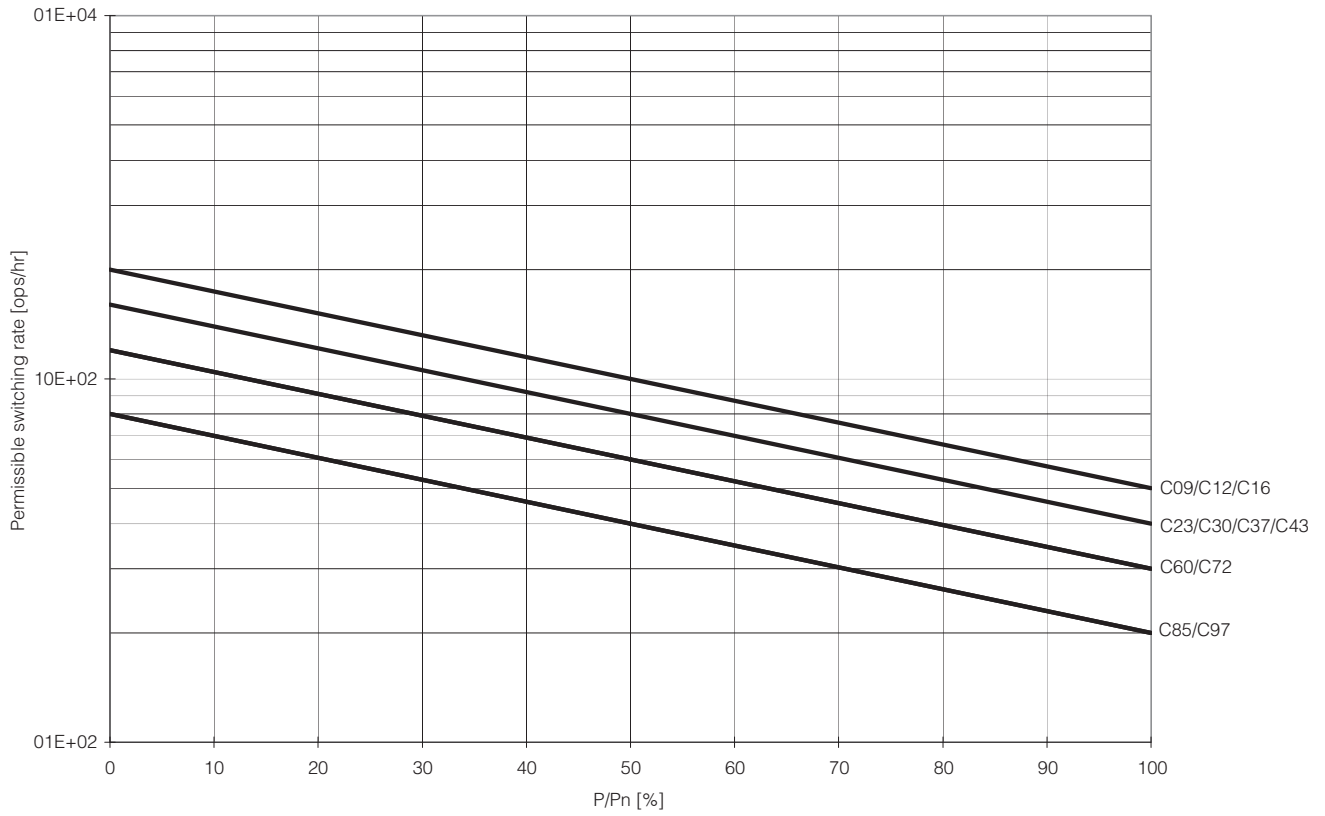



Figure 14 - AC-2, Stepping of slip-ring motors;  $U_e = 230...460V$



**Figure 15 - AC-3, Switching of squirrel-cage motors while starting;  $U_e = 230...460V$ ; Relative operating time 40%, Starting time  $t_A = 0.25 s$**

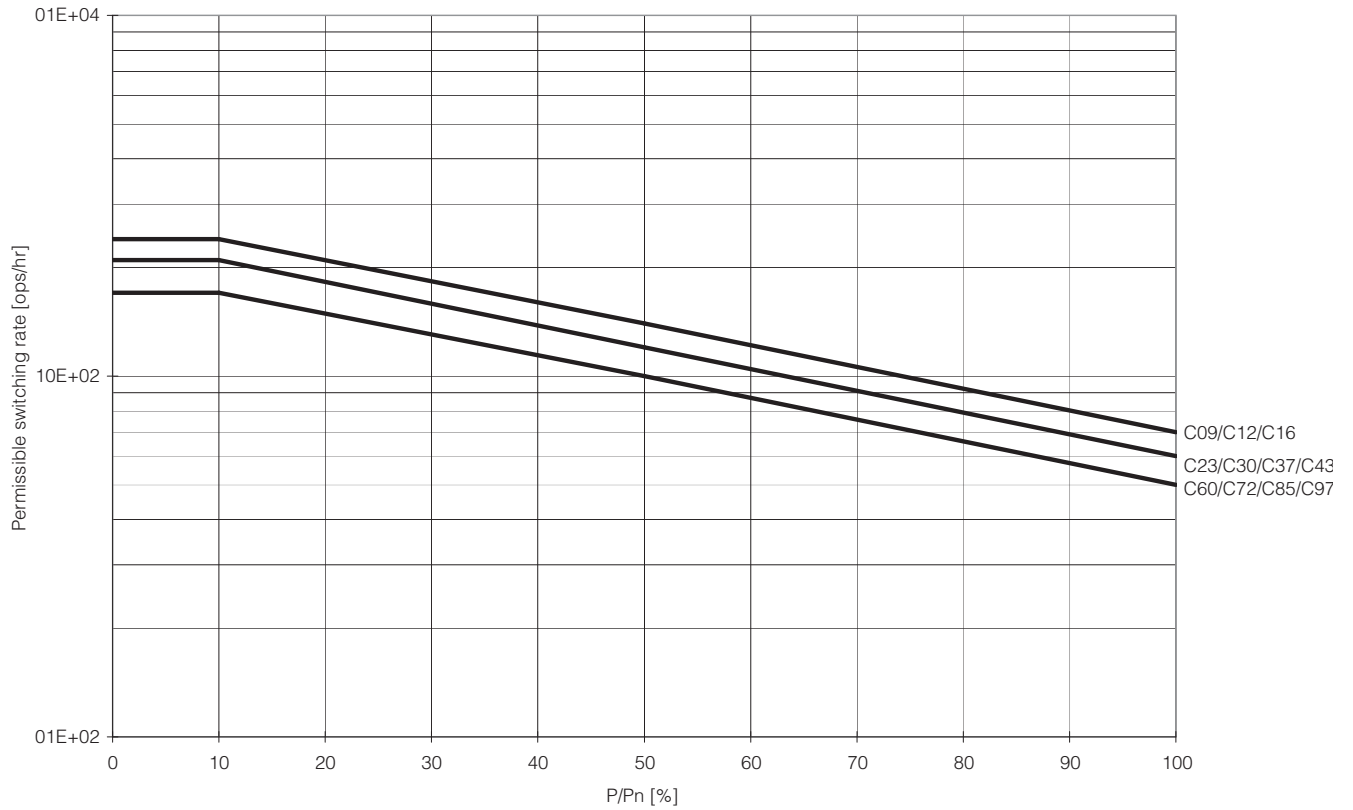
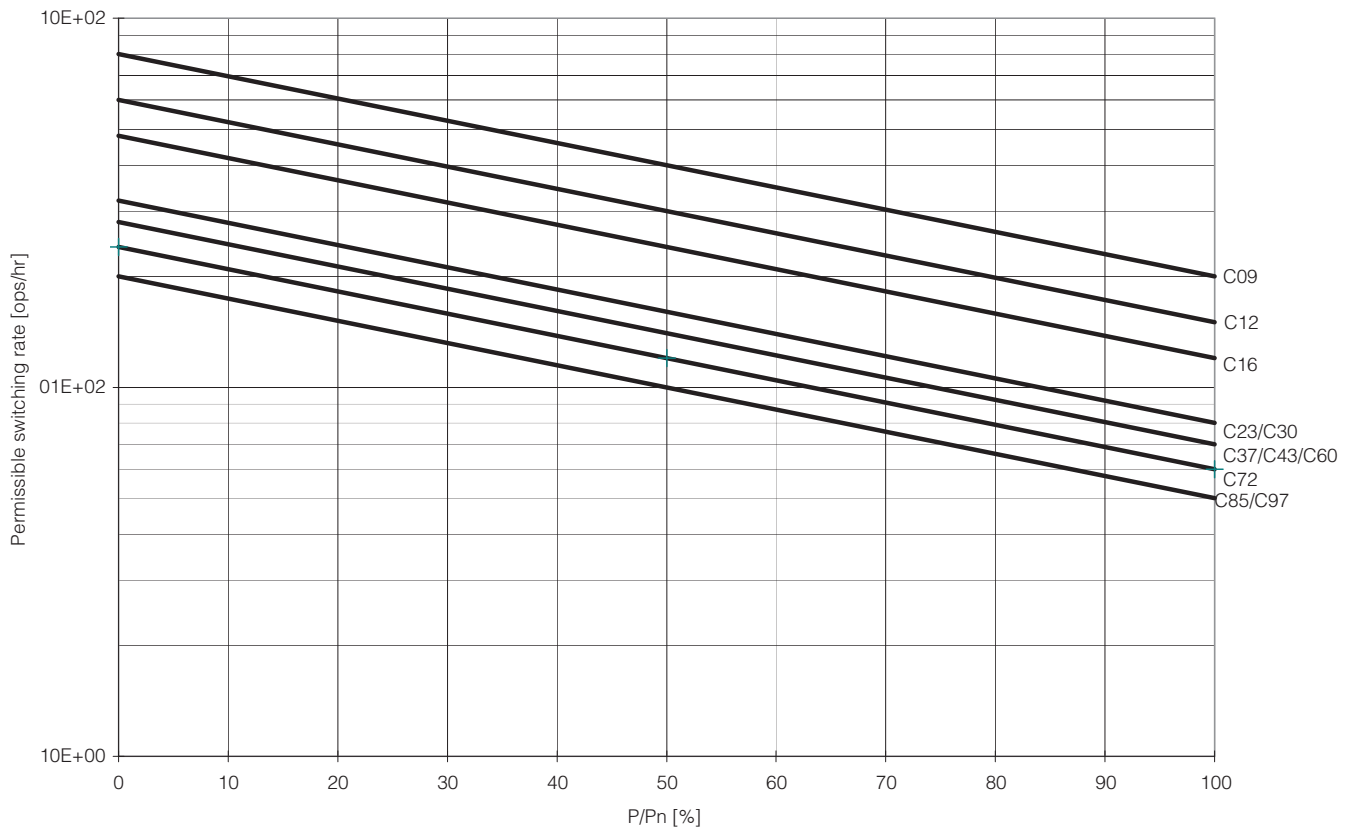

Figure 16 - AC-4, Inching of squirrel-cage motors;  $U_e = 230 \dots 460V$ , Starting time  $t_A = 0.25 s$



# Approximate Dimensions

Dimensions are shown in millimeters (inches). Dimensions are not intended for manufacturing purposes.

## Bulletin 100-C/104-C, 100S-C/104S-C Approximate Dimensions

Figure 17 - Bulletin 100-C/100S-C Contactors and Accessories

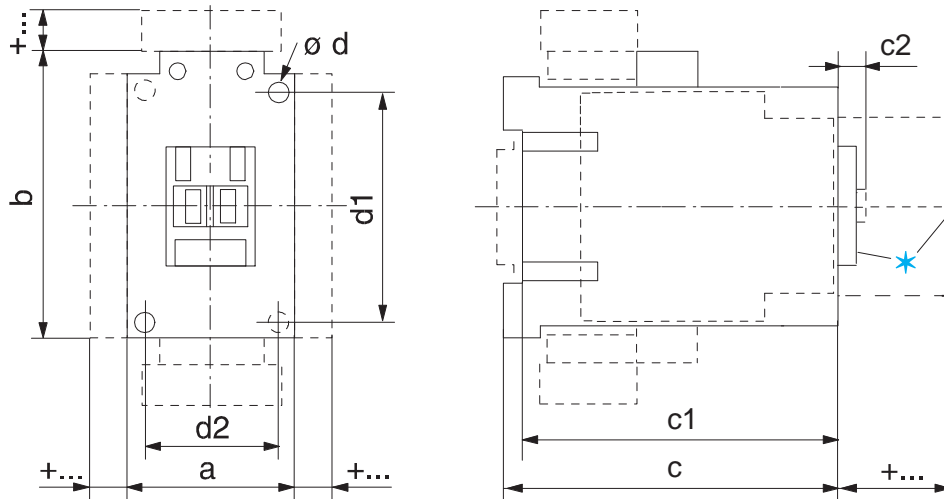

Figure 18 - Mounting Position — 100-C Contactors; 100S-C AC Contactors and DC contactors with electronic coils

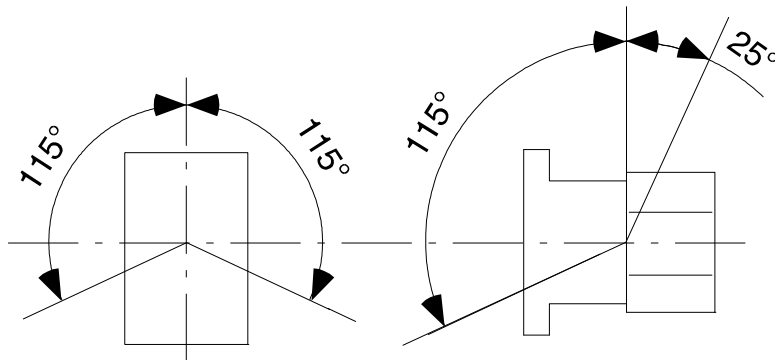
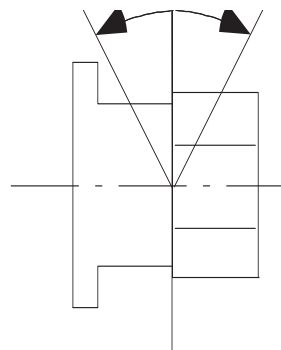

Figure 19 - Mounting Position — 100S-C DC contactors



**Table 2 - AC Contactors and DC Contactors with 12V or 24V Electronic Coils**

Cat. No.	a	b	c	c1	c2	∅ d	d1	d2
100-C09...100-C23	45 (1-25/32)	81 (3-3/16)	80.5 (3-11/64)	75.5 (2-31/32)	6 (15/64)	2 - 4.5 (2-3/16)	60 (2-23/64)	35 (1-3/8)
100-C30, 100-C37	45 (1-25/32)	81 (3-3/16)	97.5 (4)	92.5 (3-41/64)	6.5 (1/4)	2 - 4.5 (2-3/16)	60 (2-23/64)	35 (1-3/8)
100-C40	59 (2-21/64)	81 (3-3/16)	100.5 (3-61/64)	95.5 (3-49/64)	6.5 (1/4)	2 - 4.5 (2-3/16)	60 (2-23/64)	45 (1-25/32)
100-C43, 100-C55	54 (2-1/8)	81 (3-3/16)	100.5 (3-61/64)	95.5 (3-49/64)	6.5 (1/4)	2 - 4.5 (2-3/16)	60 (2-23/64)	45 (1-25/32)
100-C60...100-C97	72 (2-53/64)	122 (4-51/64)	117 (4-39/64)	111.5 (4-25/64)	8.5 (21/64)	4 - 5.4 (4 - 7/32)	100 (3-15/16)	55 (2-11/64)
100-C90	95 (3-47/64)	122 (4-51/64)	117 (4-39/64)	111.5 (4-25/64)	8.5 (21/64)	4 - 5.4 (4 - 7/32)	100 (3-15/16)	55 (2-11/64)
100S-C09...100S-C23	45 (1-25/32)	81 (3-3/16)	119.5 (4-3/4)	114.5 (4-43/64)	6 (15/64)	2 - 4.5 (2-3/16)	60 (2-23/64)	35 (1-3/8)
100S-C30, 100S-C37	45 (1-25/32)	81 (3-3/16)	136.5 (5-37/64)	131.6 (5-11/32)	6.5 (1/4)	2 - 4.5 (2-3/16)	60 (2-23/64)	35 (1-3/8)
100S-C43, 100S-C55	54 (2-1/8)	81 (3-3/16)	139.5 (5-11/16)	134.6 (5-29/64)	6.5 (1/4)	2 - 4.5 (2-3/16)	60 (2-23/64)	45 (1-25/32)
100S-C60...100S-C97	72 (2-53/64)	122 (4-51/64)	156 (6-11/32)	150.5 (6-1/8)	8.5 (21/64)	4 - 5.4 (4 - 7/32)	100 (3-15/16)	55 (2-11/64)

**Table 3 - DC Contactors with Conventional Coils**

Cat. No.	a	b	c	c1	c2	∅ d	d1	d2
100-C60D...100-C97D	72 (2-53/64)	122 (4-51/64)	117 (4-39/64)	111.5 (4-25/64)	8.5 (21/64)	4 - 5.4 (4 - 7/32)	100 (3-15/16)	55 (2-11/64)
100-C90D	95 (3-47/64)	81 (3-3/16)	117 (4-39/64)	111.5 (4-25/64)	8.5 (21/64)	4 - 5.4 (4 - 7/32)	100 (3-15/16)	55 (2-11/64)
100S-C60D...100S-C97D	72 (2-53/64)	122 (4-51/64)	156 (6-11/32)	150.5 (6-1/8)	8.5 (21/64)	4 - 5.4 (4 - 7/32)	100 (3-15/16)	55 (2-11/64)

**Table 4 - DC Contactors with 36...48V, 48...72V, 110...125V, or 200...250V DC Electronic Coils**

Cat. No.	a	b	c	c1	c2	∅ d	d1	d2
100-C09E...100-C23E	45 (1-25/32)	105 (4-1/8)	80.5 (3-11/64)	75.5 (2-31/32)	6 (15/64)	2 - 4.5 (2-3/16)	60 (2-23/64)	35 (1-3/8)
100-C30E...100-C37E	45 (1-25/32)	105 (4-1/8)	97.5 (4)	92.5 (3-41/64)	6.5 (1/4)	2 - 4.5 (2-3/16)	60 (2-23/64)	35 (1-3/8)
100-C40E	59 (2-21/64)	105 (4-1/8)	100.5 (3-61/64)	95.5 (3-49/64)	6.5 (1/4)	2 - 4.5 (2-3/16)	60 (2-23/64)	45 (1-25/32)
100-C43E...100-C55E	54 (2-1/8)	105 (4-1/8)	100.5 (3-61/64)	95.5 (3-49/64)	6.5 (1/4)	2 - 4.5 (2-3/16)	60 (2-23/64)	45 (1-25/32)
100S-C09E...100S-C23E	45 (1-25/32)	105 (4-1/8)	119.5 (4-3/4)	114.5 (4-43/64)	6 (15/64)	2 - 4.5 (2-3/16)	60 (2-23/64)	35 (1-3/8)
100S-C30E...100S-C37E	45 (1-25/32)	105 (4-1/8)	136.5 (5-37/64)	131.6 (5-11/32)	6.5 (1/4)	2 - 4.5 (2-3/16)	60 (2-23/64)	35 (1-3/8)
100S-C43E...100S-C55E	54 (2-1/8)	105 (4-1/8)	139.5 (5-11/16)	134.6 (5-29/64)	6.5 (1/4)	2 - 4.5 (2-3/16)	60 (2-23/64)	45 (1-25/32)

**Table 5 - 100-C/104-C Accessories**

Contactors with		mm	(inches)
Auxiliary contact block for front mounting	2- or 4-pole	c/c1 + 39	(c/c1 + 1-37/64)
Auxiliary contact block for side mounting	1- or 2-pole	a + 9	(a + 23/64)
Pneumatic Timing Module		c/c1 + 58	(c/c1 + 2-23/64)
Electronic Timing Module	on coil terminal side	b + 24	(b + 15/16)
Mechanical Interlock	on side of contactor	a + 9	(a + 23/64)
Mechanical Latch		c/c1 + 61	(c/c1 + 2-31/64)
Interface Module	on coil terminal side	b + 9	(b + 23/64)
Surge Suppressor	on coil terminal side	b + 3	(b + 1/8)
Labeling with . . .	label sheet	+ 0	(+ 0)
	marking tag sheet with clear cover	+ 0	(+ 0)
	marking tag adapter for System V4 / V5	+ 5.5	(+ 7/32)
	marking tag adapter for System Bul. 1492W	+ 5.5	(+ 7/32)
Terminal Lug Kit	100-C09 . . . C23	b + 53	(b + 2-3/32)
	100-C30 . . . C37	b + 44	(b + 1-47/64)
	100-C43 . . . C55	b + 52	(b + 2-3/64)
	100-C60 . . . C97	b + 99	(b + 3-7/8)
Paralleling Links	100-C09 . . . C23	b + 78	(b + 3-1/16)
		c + 9/5	(c + 3/8)
	100-C30 . . . C37	b + 85	(b + 3-11/32)

**Table 6 - 100S-C/104S-C Accessories**

Contactors with		mm	(inches)
Auxiliary contact block for side mounting	1- or 2-pole	a + 9	(a + 23/64)
Electronic Timing Module	on coil terminal side	b + 24	(b + 15/16)
Mechanical Interlock	on side of contactor	a + 9	(a + 23/64)
Interface Module	on coil terminal side	b + 9	(b + 23/64)
Surge Suppressor	on coil terminal side	b + 3	(b + 1/8)
Labeling with	label sheet	+ 0	(+ 0)
	marking tag sheet with clear cover	+ 0	(+ 0)
	marking tag adapter for System V4 / V5	+ 5.5	(+ 7/32)
	marking tag adapter for System Bul. 1492W	+ 5.5	(+ 7/32)

## Bulletin 100Q-C Approximate Dimensions

Figure 20 - Bulletin 100Q- Contactors

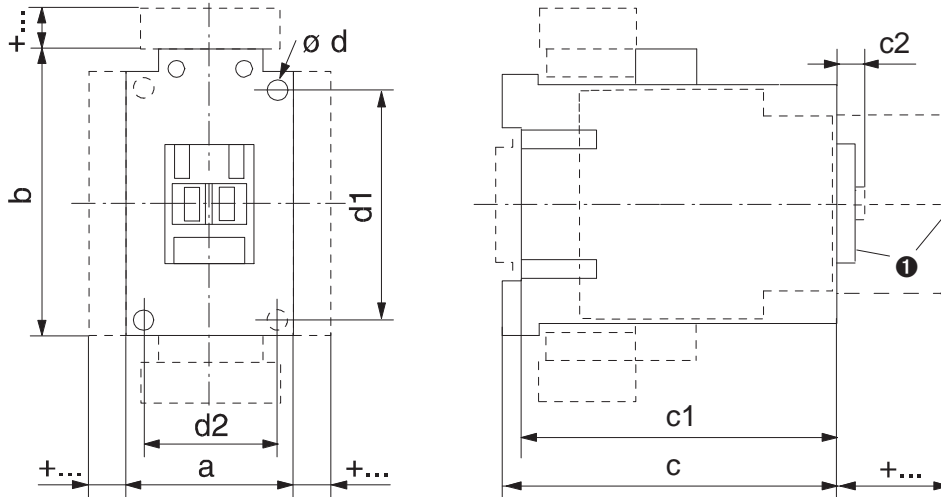

Table 7 - AC Contactors and DC Contactors with 12V or 24V Electronic Coils

Cat. No.	a	b	c	c1	c2	Ø d	d1	d2
100Q-C16	45 (1-25/32)	81 (3-3/16)	119.5 (4-3/4)	114.5 (4-43/64)	6 (15/64)	2 - 4.5 (2 -3/16)	60 (2-23/64)	35 (1-3/8)
100Q-C37	45 (1-25/32)	81 (3-3/16)	136.5 (5-37/64)	131.6 (5-11/32)	6.5 (1/4)	2 - 4.5 (2 -3/16)	60 (2-23/64)	35 (1-3/8)

Table 8 - DC Contactors with Conventional Coils

Cat. No.	a	b	c	c1	c2	Ø d	d1	d2
100Q-C16	45 (1-25/32)	81 (3-3/16)	145.5 (5-49/64)	140.5 (5-37/64)	6 (15/64)	2 - 4.5 (2 -3/16)	60 (2-23/64)	35 (1-3/8)
100Q-C37	45 (1-25/32)	81 (3-3/16)	180.5 (7-5/32)	175.5 (6-61/64)	6.5 (1/4)	2 - 4.5 (2 -3/16)	60 (2-23/64)	35 (1-3/8)

Table 9 - DC Contactors with 36...48V, 48...72V, 110...125V, or 200...250V DC Electronic Coils

Cat. No.	a	b	c	c1	c2	Ø d	d1	d2
100Q-C16EA, -ED, or -EY	45 (1-25/32)	105 (4-1/8)	119.5 (4-3/4)	114.5 (4-43/64)	6 (15/64)	2 - 4.5 (2 -3/16)	60 (2-23/64)	35 (1-3/8)
100Q-C37EA, -ED, or -EY	45 (1-25/32)	105 (4-1/8)	136.5 (5-37/64)	131.6 (5-11/32)	6.5 (1/4)	2 - 4.5 (2 -3/16)	60 (2-23/64)	35 (1-3/8)

Notes:



# 100-E/104-E, 100S-E/104S-E Contactors

## Product Selection—100-E/104-E Contactors

- 55...560 kW @ 400V
- 75...900 Hp @ 460V
- AC-1 ratings up to 2650 A
- Compact Dimensions
- Electronic Coils
  - AC/DC
  - Wide voltage range
  - Low power pick-up and hold-in
  - Optional PLC interface
- Complete range of accessories
- Environmentally friendly



100-E116 Contactor



100-E860 Contactor

The Bulletin 100-E/104-E contactor family, along with a wide range of accessories, provides the most compact and flexible contactor system available.

### 3-Pole AC- and DC-operated Contactors

- Electronic Coils
- 3 Main Contacts
- Direct On-Line or Reversing

Rated Operational Current $I_e$ [A]		Ratings for switching AC motors - AC-2, AC-3											Auxiliary Contacts		Direct On-Line Contactor	Reversing Contactor
60 °C	40 °C	kW (50 Hz)							Hp (60 Hz)						Cat No.	Cat No.
AC-3 (400V)	AC-1 (690V)	220-240V	380-400V	415V	440V	500V	690V	1000V	200V	230V	460V	575V	N.O.	N.C.		
116	160	37	55	55	75	75	63	55	30	40	75	100	1	1	100-E116⊗11 <sup>(1)</sup>	104-E116⊗22 <sup>(1)</sup>
146	225	45	75	75	90	90	90	75	40	50	100	125	1	1	100-E146⊗11 <sup>(1)</sup>	104-E146⊗22 <sup>(1)</sup>
190	275	55	90	90	110	110	132	110	50	60	125	150	1	1	100-E190⊗11	104-E190⊗22
205	350	55	110	110	132	132	160	132	60	75	150	200	1	1	100-E205⊗11	104-E205⊗22
265	400	75	132	132	160	160	200	160	75	100	200	250	1	1	100-E265⊗11	104-E265⊗22
305	500	90	160	160	160	200	250	185	100	125	250	300	1	1	100-E305⊗11	104-E305⊗22
370	600	110	200	200	200	250	315	200	125	150	300	350	1	1	100-E370⊗11	104-E370⊗22
400	600	110	200	220	220	250	315	220	125	150	350	400	1	1	100-E400⊗11	104-E400⊗22
460	700	132	250	250	250	315	355	280	150	200	400	500	1	1	100-E460⊗11	104-E460⊗22
580	800	160	315	355	355	400	500	355	200	250	500	600	1	1	100-E580⊗11	104-E580⊗22
750	1050	220	400	425	450	530	600	400	250	300	600	700	1	1	100-E750⊗11	104-E750⊗22
860	1350	250	475	500	560	630	800	555	—	400	800	1000	1	1	100-E860⊗11	—
1060	1650	315	560	630	710	710	1000	600	—	450	900	1150	1	1	100-E1060⊗11	—
—	1260	—	—	—	—	—	—	—	—	—	—	—	1	1	100-E1260⊗11	—
—	2050	—	—	—	—	—	—	—	—	—	—	—	1	1	100-E2050⊗11	—
—	2650	—	—	—	—	—	—	—	—	—	—	—	1	1	100-E2650⊗11	—

(1) To order with built-in terminal lugs, add the letter "L" to the end of the catalog number (e.g. **100-E116⊗11L**).

⊗ Coil voltage code and PLC interface—see [page 74](#)

## Coil Voltage Codes

The Cat. No. as listed is incomplete. Select a coil voltage code from the table below to complete the Cat. No.

Example: 100-E116KJ11)

Electronic Coils	V	24-60V	48-130V	100-250V	250-500V
100-E116...100-E370	AC/DC	KJ	KY	KD	KN
100-E116...100-E370 <sup>(1)</sup>	AC/DC with PLC Input	—	—	ED	EN
100-E400...100-E750		EJ <sup>(2)</sup>	EY	ED	EN
100-E860...100-1060		—	—	ED	—
100-E1260		EJ <sup>(2)</sup>	EY	ED	EN
100-E2050...100-E2650		—	—	ED	—

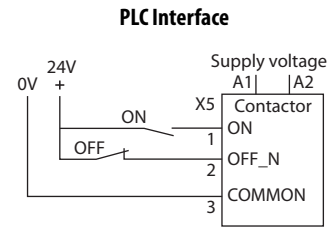

(1) When ordering coil with PLC input, the PLC input must be used

(2) 24V...60V DC only

# Product Selection—100S-E Safety Contactors

## 3-Pole AC- and DC-operated Safety Contactors

- Electronic Coils
- 3 Main Contacts
- Direct On-Line
- Low-power auxiliary contact for feedback circuit
- Mirror contact performance



Rated Operational Current I <sub>e</sub> [A]		Ratings for switching AC motors - AC-2, AC-3											Auxiliary contacts per contactor			Direct On-Line Contactor
60 °C	40 °C	kW (50 Hz)							Hp (60 Hz)				N.O.	N.C.	N.C. <sup>(1)</sup>	
AC-3 (400V)	AC-1 (690V)	220-240V	380-400V	415V	440V	500V	690V	1000V	200V	230V	460V	575V				
116	160	37	55	55	75	75	55	—	30	40	75	100	1	1	1	100S-E116⊗12C <sup>(2)</sup>
146	225	45	75	75	90	90	90	75	40	50	100	125	1	1	1	100S-E146⊗12C <sup>(2)</sup>
190	275	55	90	90	110	90	132	110	50	60	125	150	1	1	1	100S-E190⊗12C
205	350	55	110	110	132	110	160	132	60	75	150	200	1	1	1	100S-E205⊗12C
265	400	75	132	132	160	160	200	132	75	100	200	250	1	1	1	100S-E265⊗12C
305	500	90	160	160	160	200	250	132	100	125	250	300	1	1	1	100S-E305⊗12C
370	600	110	200	200	200	220	315	132	125	150	300	350	1	1	1	100S-E370⊗12C
400	600	110	200	220	220	250	315	220	125	150	350	400	1	1	1	100S-E400⊗12C
460	700	132	250	250	250	315	355	280	150	200	400	500	1	1	1	100S-E460⊗12C
580	800	160	315	355	355	400	500	355	200	250	500	600	1	1	1	100S-E580⊗12C
750	1050	220	400	425	450	530	600	400	250	300	600	700	1	1	1	100S-E750⊗12C

(1) The N.C. contact meets IEC 60947-4-1 Annex F requirements for mirror contact performance.

(2) To order with built-in terminal lugs, add the letter "L" to the end of the catalog number (e.g. 100S-E116⊗12CL)

⊗ Coil voltage code and PLC interface—see [page 75](#)

## Coil Voltage Codes

The Cat. No. as listed is incomplete. Select a coil voltage code from the table below to complete the Cat. No.

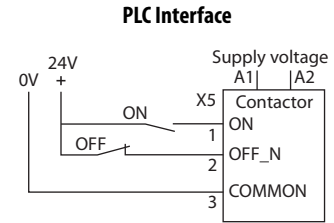

Example: 100S-E116KJ11)

Electronic Coils	V	24-60V	48-130V	100-250V	250-500V
100S-E116...100S-E370	AC/DC	KJ	KY	KD	KN
100S-E116...100S-E370 <sup>(1)</sup>	AC/DC with PLC Input	—	—	ED	EN
100S-E400...100S-E750		EJ <sup>(2)</sup>	EY	ED	EN



(1) When ordering coil with PLC input, the PLC input must be used  
 (2) 24V...60V DC only

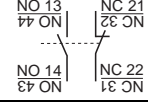
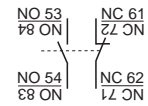
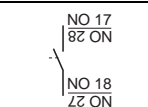
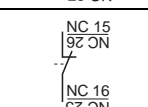

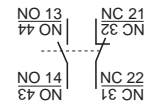
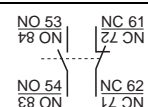
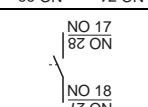
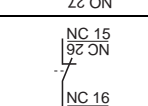
## Accessories

	Description			Connection Diagrams	For Use With	Standard Auxiliary Contact	
		N.O.	N.C.			Cat. No.	
	Auxiliary Contact Blocks for Side Mounting with Sequence Terminal Designations <ul style="list-style-type: none"> <li>2-pole</li> <li>Two-way numbering for right or left mounting on the contactor</li> <li>Quick and easy mounting without tools</li> <li>Mirror contact performance to the main contactor poles</li> <li>Low power switching down to 24V 50 mA</li> </ul>	1	1		100-E116...E370, left or right inside mounting	100-ES1-11	
		1	1		100-E116...E370, left or right outside mounting	100-ES2-11	
	Low-power Auxiliary Contact Blocks for Side Mounting with Sequence Terminal Designations <sup>(1)</sup> <ul style="list-style-type: none"> <li>1-pole</li> <li>Two-way numbering for right or left mounting on the contactor</li> <li>Quick and easy mounting without tools</li> <li>Mirror contact performance to the main contactor poles</li> <li>Electronic compatible, 3V 1 mA</li> </ul>	1	0		100-E116...E370, left or right inside or outside mounting	100-ES1-B10	
		0	1		100-E116...E370, left or right inside or outside mounting	100-ES1-B01	
		Auxiliary Contact Blocks for Side Mounting with Sequence Terminal Designations <ul style="list-style-type: none"> <li>2-pole</li> <li>Two-way numbering for right or left mounting on the contactor</li> <li>Quick and easy mounting without tools</li> <li>Mirror contact performance to the main contactor poles</li> <li>Low power switching down to 24V 50 mA</li> </ul>	1	1		100-E400...E2650, left or right inside mounting	100-ES3-11
			1	1		100-E400...E2650, left or right outside mounting	100-ES4-11
Low-power Auxiliary Contact Blocks for Side Mounting with Sequence Terminal Designations <sup>(1)</sup> <ul style="list-style-type: none"> <li>1-pole</li> <li>Two-way numbering for right or left mounting on the contactor</li> <li>Quick and easy mounting without tools</li> <li>Mirror contact performance to the main contactor poles</li> <li>Electronic compatible, 3V 1 mA</li> </ul>		1	0		100-E400...E2650, left or right inside or outside mounting	100-ES3-B10	
		0	1		100-E400...E2650, left or right inside or outside mounting	100-ES3-B01	

(1) No auxiliary contacts blocks can be mounted on the outside of the 100-ES1-B\* or 100-ES3-B\*.

	Description	Connection Diagrams	For Use With	Cat. No.
 <p>Mechanical Interlocks</p> <ul style="list-style-type: none"> <li>For interlocking of two contactors.</li> <li>Interlocking of different sizes possible</li> </ul>	<p>Mechanical only, without auxiliary contacts</p>	<p>---▽---</p>	100-E116...100-E146	100-EM1-00
			100-E190...100-E205	
			100-E265...100-E370	
			100-E116...100-E146 to 100-E190...100-E205	100-EM4-00
			100-E190...100-E205 to 100-E265...100-E370	100-EM5-00
			100-E400...100-E750, 100-E1260 <sup>(1)</sup>	100-EM2-00
			100-E860...100-E1060, 100-E2050...100-E2650 <sup>(2)</sup>	100-EM3-00
			Rod for vertical mounting 100-E400...E750 reversing contactors	100-EVR750

- (1) Mounting plate ordered separately  
 (2) Mounting plate included



	Description	Wire Sizes	For Use With	Cat. No.
 <p>Terminal Lug Kit</p> <ul style="list-style-type: none"> <li>Standard on 100-E116*L...100-E146*L contactors</li> <li>Set of two</li> </ul>		2 x 6 AWG...3/0 AWG	100-E116...100-E146	100-ECL146
 <p>Terminal Lugs</p> <ul style="list-style-type: none"> <li>Set of three</li> </ul>		6 AWG...300 MCM	100-E190...100-E205	100-ETL205
		4 AWG...400 MCM	100-E265...100-E370	100-ETL370
		(2x) 4 AWG...500 MCM	100-E265...100-E370	100-ETL370B
		(2x) 2/0 AWG...500 MCM	100-E400...100-E460	100-ETL580
		(3x) 2/0 AWG...500 MCM	100-E580...E750, 100-E1260	100-ETL750
		(4x) 4/0 AWG...500 MCM	100-E860	100-ETL860
		(4x) 1/0 AWG...750 MCM	100-E1060	100-ETL1060
	(6x) 1/0 AWG...750 MCM	100-E1060	100-ETL1060B	

	Description	Wires with Compression Lugs	Contactor with Terminal Lugs	For Use With	Cat. No.	
 <p>Terminal Shrouds</p> <ul style="list-style-type: none"> <li>Not applicable when using 105-PW* or 170-PW* power wiring kits</li> </ul>		X		100-E116...100-E146	100-ETS146L	
				X	100-E190...100-E205	100-ETS205L
		X			100-E190...100-E205	100-ETS205C
				X	100-E265...100-E370	100-ETS370L <sup>(1)</sup>
		X			100-E265...100-E370	100-ETS370C
				X	100-E400...100-E460	100-ETS460L
		X			100-E400...100-E460	100-ETS460C
				X	100-E580...100-E750	100-ETS750L
		X		100-E580...100-E750, 100-E1260	100-ETS750C	
	IP20 terminal shield between contactor and 193-E overload relay on an assembled direct on-line starter			100-E116...100-E146	100-ETC146	
				100-E190...100-E205	100-ETC205	
	IP20 terminal shield between contactor and 193-E overload relay on an assembled reversing starter			100-E116...100-E146	100-ETCR146	
				100-E190...100-E205	100-ETCR205	

- (1) Not applicable when using the 100-ETL370B lug kit.

	Description	For Use With	Cat. No.
 <p>Reversing Power Wiring Kits</p>		100-E116...100-E146	105-PW146
		100-E190...100-E205	105-PW205 <sup>(1)</sup>
		100-E265...100-E370	105-PW370 <sup>(1)</sup>
		100-E400...100-E460	105-PW460 <sup>(2)</sup>
		100-E580...100-E750	105-PW750 <sup>(2)</sup>

- (1) Kits includes one set of terminal extensions. If 100-ETL\* terminal lugs are to be used on line and load side of reversing contactor, and second set of 100-ETX terminal extensions is required.  
 (2) If 100-ETL\* terminal lugs are to be used on line and load side of reversing contactor, two sets of 100-ETX terminal extensions are also required.

	Description	For Use With		Cat. No.
		Delta Contactor	Wye Contactor	Cat. No.
 <p>Wye-Delta Power Wiring Kits</p>		100-E116...100-E146	100-E116...100-E146	170-PW146
		100-E190...100-E205	100-E116...100-E146	170-PW190
		100-E190...100-E205	100-E190...100-E205	170-PW205
		100-E265...100-E370	100-E190...100-E205	170-PW265
		100-E265...100-E370	100-E265...100-E370	170-PW370
		100-E400...100-E460	100-E400...100-E460	170-PW460
		100-E580...100-E750	100-E400...100-E460	170-PW580
		100-E580...100-E750	100-E580...100-E750	170-PW750
 <p>Shorting Bars</p>			100-E116...100-E146	170-PWY146
			100-E190...100-E205	170-PWY205
			100-E265...100-E370	170-PWY370
			100-E400...100-E460	170-PWY460
			100-E580...100-E750	170-PWY750

	Description	For Use With	Cat. No.	
 <p>For Direct On-Line Starters</p> <p>For Reversing Starters</p>		100-E116...100-E146	100-EMS146	
		100-E190...100-E205	100-EMS205	
	For Reversing Contactors		100-E116...100-E146	100-EMR146
			100-E190...100-E205	100-EMR205
			100-E265...100-E370	100-EMR370
			100-E400...100-E460	100-EMR460
			100-E580...100-E750	100-EMR750
	For Reversing Starters		100-E116...100-E146	100-EMRS146
			100-E190...100-E205	100-EMRS205

	Description	For Use With Circuit Breaker	For Use With Contactor	Cat. No.
 <p>For Connection to 140G or 140MG</p> <ul style="list-style-type: none"> <li>• Connection between contactors/starters and molded case circuit breakers.</li> <li>• These connection sets are solid copper bars.</li> </ul>		140G-H, 140MG-H	100-E116...100-E146	100-PCE1
		140G-I, 140MG-I	100-E116...100-E146	100-PCE2
		140G-J, 140MG-J	100-E116...100-E146	100-PCE3
		140G-J, 140MG-J	100-E190...100-E205	100-PCE4
		140G-K, 140MG-K	100-E265...100-E370	100-PCE5
		140G-M, 140MG-M	100-E400...100-E750	100-PCE6
		140G-K, 140MG-K	100-E400...100-E750	100-PCE7

	Description	For Use With Contactor	Cat. No.
 <p>Terminal Enlargements</p> <ul style="list-style-type: none"> <li>• Enlargement pieces designed to increase the width of the contactor terminal pads in order to allow larger connections to be mounted.</li> </ul>		100-E116...100-E146	100-ETE146
		100-E190...100-E205	100-ETE205
		100-E265...100-E370	100-ETE370
		100-E400...100-E460	100-ETE460
		100-E580...100-E750	100-ETE750
		100-E1260	100-ETE1260

	Description	For Use With Contactor	Cat. No.
 <p>Terminal Extensions</p> <ul style="list-style-type: none"> <li>• Extension pieces designed to extend the main terminals of contactors for combined mounting of contactors and connection sets</li> </ul>		100-E116...100-E146	100-ETX146
		100-E190...100-E205	100-ETX205
		100-E265...100-E370	100-ETX370
		100-E400...100-E460	100-ETX460
		100-E580...100-E750	100-ETX750

# Renewal Parts

	Description	For Use With	Voltage	Cat. No.
 <p>Coil Modules</p>		100-E116	24...60V AC/DC	TG913
			48...130V AC/DC	TG914
			100...250V AC/DC	TG915
			250...500V AC/DC	TG916
			100...250V AC/DC w/ PLC Interface	TGE913
			250...500V AC/DC w/ PLC Interface	TGE914
		100-E146	24...60V AC/DC	TG901
			48...130V AC/DC	TG902
			100...250V AC/DC	TG903
			250...500V AC/DC	TG904
			100...250V AC/DC w/ PLC Interface	TGE903
			250...500V AC/DC w/ PLC Interface	TGE904
		100-E190, 100-E205	24...60V AC/DC	TG905
			48...130V AC/DC	TG906
			100...250V AC/DC	TG907
			250...500V AC/DC	TG908
		100-E190	100...250V AC/DC w/ PLC Interface	TGE915
			250...500V AC/DC w/ PLC Interface	TGE916
		100-E205	100...250V AC/DC w/ PLC Interface	TGE907
			250...500V AC/DC w/ PLC Interface	TGE908
		100-E265, 100-E305, 100-E370	24...60V AC/DC	TG909
			48...130V AC/DC	TG910
			100...250V AC/DC	TG911
			250...500V AC/DC	TG912
		100-E265	100...250V AC/DC w/ PLC Interface	TGE917
			250...500V AC/DC w/ PLC Interface	TGE918
		100-E305	100...250V AC/DC w/ PLC Interface	TGE919
			250...500V AC/DC w/ PLC Interface	TGE920
		100-E370	100...250V AC/DC w/ PLC Interface	TGE911
			250...500V AC/DC w/ PLC Interface	TGE912
		100-E400, 100-E460	24...60V DC w/ PLC Interface	THE901
			48...130V AC/DC w/ PLC Interface	THE902
100...250V AC/DC w/ PLC Interface	THE903			
250...500V AC/DC w/ PLC Interface	THE904			
100-E580, 100-E750, 100-E1260	24...60V DC w/ PLC Interface	TJE901		
	48...130V AC/DC w/ PLC Interface	TJE902		
	100...250V AC/DC w/ PLC Interface	TJE903		
	250...500V AC/DC w/ PLC Interface	TJE904		
100-E860, 100-E1060, 100-E2050	100...250V AC/DC w/ PLC Interface	TKE903 <sup>(1)</sup>		
		TKE904 <sup>(2)</sup>		
100-E2650	100...250V AC/DC w/ PLC Interface	TLE903 <sup>(1)</sup>		
		TLE904 <sup>(2)</sup>		

(1) One set of two coils  
 (2) Printed circuit board

	Description	For Use With	Cat. No.	
	Contact Kits	100-E116	100-EA116	
		100-E146	100-EA146	
		100-E190	100-EA190	
		100-E205	100-EA205	
		100-E2650	100-EA265	
		100-E305	100-EA305	
		100-E370	100-EA370	
		100-E400	100-EA400	
		100-E460	100-EA460	
		100-E580	100-EA580	
		100-E750	100-EA750	
		100-E1260	100-EA1260	
		100-E860	100-EA860	
		100-E1060	100-EA1060	
		100-E2050	100-EA2050	
		100-E2650 <sup>(1)</sup>	100-EA2650	
		Arc Chutes	100-E400, 100-E460	100-EC460
			100-E580, 100-E750, 100-E1260	100-EC750
		100-E860, 1060, 100-E2050	100-EC1060	
		100-E2650	100-EC2650	

(1) Movable contacts only

	Description	For Use With	Cat. No.
	Terminal and Mounting Hardware Kits	100-E116*L, 100-E146*L	100-EHS146 <sup>(1)</sup>
		100-E116, 100-E146	100-EHF146
		100-E190, 100-E205	100-EHF205
		100-E265, 100-E305, 100-E370	100-EHF370
		100-E400, 100-E460	100-EHF460
		100-E580, 100-E750, 100-E1260	100-EHF750
		100-E860, 100-E1060, 100-E2050	100-EHF2050
	100-E2650	100-EHF2650	

(1) Mounting hardware only.

# Specifications

		100-E, 100S-E
<b>Rated Isolation Voltage <math>U_i</math></b>		
IEC	[V]	1000
UL, CSA	[V]	600
Rated Impulse Voltage Withstand $U_{imp}$	[kV]	8
<b>Rated Voltage <math>U_e</math></b>		
AC 50/60 Hz	[V]	115, 200, 230, 240, 400, 415, 460 500, 575, 690, 1000
DC	[V]	24, 48, 110, 220, 440
Electromagnetic compatibility		IEC 60947-1 - Environment A
Insulation Class of the Coil		Class F per IEC 60947-4-1
Rated coil frequency		AC 50/60 Hz, DC
<b>Ambient Temperature</b>		
Storage	[°C]	-40...+70
Operation at rated voltage	[°C]	-40...+70
Max. Altitude of Installation Site	[m]	3000
<b>Climatic Withstand</b>		
100-E116...100-E370		IEC 60068-2-30 Test Db & IEC 60068-2-2 test Bd & IEC 60068-2-1 test Ab (report 1314369)
100-E400...100-E2650		IEC 60068-2-2 test Ba & Bb & IEC 60068-2-1 test Aa&Ab, IEC 60068-2-30
Resistance to Shock		IEC 60068-2-27
Resistance to Vibration		IEC 60068-2-6
<b>Protection Class</b>		
Contactor main contacts		IP00
Contactor coil terminals		P2X (in connected state)
Auxiliary contacts		P2X (in connected state)
<b>Functional Safety Data (100S-E116...100S-E750)<sup>(1)</sup></b>		
100(S)-E116...100(S)-E370		B10: 1.0E+06 operations at 50% max. AC-3 load; failure ratio: 75% failure to open, 25% failure to close
100(S)-E116...100(S)-E370		B10: 5.0E+06 operations, mechanical only; failure ratio: 50% failure to open, 50% failure to close
100(S)-E400...100(S)-E750		B10: 5.0E+05 operations at 50% max. AC-3 load; failure ratio: 75% failure to open, 25% failure to close
100(S)-E400...100(S)-E460		B10: 3.0E+06 operations, mechanical only; failure ratio: 50% failure to open, 50% failure to close
100(S)-E570...100(S)-E750		B10: 9.0E+05 operations, mechanical only; failure ratio: 50% failure to open, 50% failure to close

(1) Usable for ISO 13849-1 and IEC 62061. Data is based on the B10 value given and: - Mission time/Proof test interval of 20 years.

## Standards and Approvals

Standards	IEC/EN 60947-1, Low-voltage switchgear and controlgear; IEC/EN 60947-4-1, Low-voltage switchgear and controlgear, Contactors and motor-starters; IEC/EN 60947-5-1, Low-voltage switchgear and controlgear, Control circuit devices and switching elements; UL 60947-4-1, Industrial Control Equipment (USA); CSA C22.2 No. 60947-4-1 Industrial Control Equipment (Canada).		
	Mechanically Linked Contacts: IEC 60947-5-1, Annex L		
	Mirror Contacts: IEC 60947-4-1, Annex F	100/100S-E116...100/100S-E750 with all 100-ES* side mounted N.C. auxiliary contacts	
Approvals	UL	cULus, File No. E41850 / E196120 (contactors, reversing contactors)	
	CSA		
	CCC		√
	EAC		√
	RCM		√
	RINA		√
	ABS		√
Certifications	KC	√	
	CE	√	
	SUVA	√	
	SEMI-F47	Conditions of use on request	



## Main Circuits

100/104-E, 100S-E			116	146	190	205	265	305	370	400	460	580	750	860	1060	1260	2050	2650
<b>AC-1 Active Power Load (50/60 Hz); Ambient temperature 40°C</b>																		
Rated Operational Current, $I_e$	690V	[A]	160	225	275	350	400	500	600	600	700	800	1050	1350	1650	1260	2050	2650
	1000V	[A]	160	225	250	275	350	375	400	600	700	800	1050	1350	1650	1260	2050	2650
Rated Operational Power, $P_e$	230V	[kW]	64	90	110	139	159	199	239	239	279	319	418	538	657	502	817	1056
	240V	[kW]	67	94	114	145	166	208	249	249	291	333	436	561	686	524	852	1102
	400V	[kW]	111	156	191	242	277	346	416	416	485	554	727	935	1143	873	1420	1836
	415V	[kW]	115	162	198	252	288	359	431	431	503	575	755	970	1186	906	1474	1905
	500V	[kW]	139	195	238	303	346	433	520	520	606	693	909	1169	1429	1091	1775	2295
	690V	[kW]	191	269	329	418	478	598	717	717	837	956	1255	1613	1972	1506	2450	3167
	1000V	[kW]	277	390	433	476	606	650	693	1039	1212	1386	1819	2338	2858	2182	3551	4590
<b>Ambient temperature 60°C</b>																		
Rated Operational Current, $I_e$	690V	[A]	145	200	250	300	350	400	500	500	600	700	875	1150	1450	1040	1750	2350
	1000V	[A]	145	200	225	250	300	325	350	500	600	700	875	1150	1450	1040	1750	2350
Rated Operational Power, $P_e$	230V	[kW]	58	80	100	120	139	159	199	199	239	279	349	458	578	414	697	936
	240V	[kW]	60	83	104	125	145	166	208	208	249	291	364	478	603	432	727	977
	400V	[kW]	100	139	173	208	242	277	346	346	416	485	606	797	1005	721	1212	1628
	415V	[kW]	104	144	180	216	252	288	359	359	431	503	629	827	1042	748	1258	1689
	500V	[kW]	126	173	217	260	303	346	433	433	520	606	758	996	1256	901	1516	2035
	690V	[kW]	173	239	299	359	418	478	598	598	717	837	1046	1374	1733	1243	2091	2809
	1000V	[kW]	251	346	390	433	520	563	606	866	1039	1212	1516	1992	2511	1801	3031	4070
<b>Ambient temperature 70°C</b>																		
Rated Operational Current, $I_e$	690V	[A]	130	175	200	240	290	325	400	400	480	580	720	1000	1270	875	1500	2120
	1000V	[A]	130	175	185	200	240	260	290	400	480	580	720	1000	1270	875	1500	2120
Rated Operational Power, $P_e$	230V	[kW]	52	70	80	96	116	129	159	159	191	231	287	398	506	349	598	845
	240V	[kW]	54	73	83	100	121	135	166	166	200	241	299	416	528	364	624	881
	400V	[kW]	90	121	139	166	201	225	277	277	333	402	499	693	880	606	1039	1469
	415V	[kW]	93	126	144	173	208	234	288	288	345	417	518	719	913	629	1078	1524
	500V	[kW]	113	152	173	208	251	281	346	346	416	502	624	866	1100	758	1299	1836
	690V	[kW]	155	209	239	287	347	388	478	478	574	693	860	1195	1518	1046	1793	2534
	1000V	[kW]	225	303	320	346	416	450	502	693	831	1005	1247	1732	2200	1516	2598	3672
With conductor sizes	[mm <sup>2</sup> ]	70	95	150	240 <sup>(1)</sup>	240	300 <sup>(2)</sup>	2x185 <sup>(2)</sup>	2x185	2x240	2x240	800 <sup>(3)</sup>	1000 <sup>(4)</sup>	1500 <sup>(4)</sup>	1000 <sup>(3)</sup>	2000 <sup>(4)</sup>	3000 <sup>(4)</sup>	

(1) For currents above 275A, use terminal extensions.

(2) For currents above 450A, use terminal extensions.

(3) Maximum connection bar width 50 mm.

(4) Maximum connection bar width 100 mm.

100/104-E, 100S-E			116	146	190	205	265	305	370	400	460	580	750	860	1060	1260	2050	2650
<b>Switching of 3-phase Motors; (50 Hz)</b>																		
<b>Ambient temperature 60°C, AC-2, AC-3</b>																		
Rated Operational Current, $I_e$	220-240V	[A]	116	146	190	205	265	305	370	400	460	580	750	860	1060	—	—	—
	380-400V	[A]	116	146	190	205	265	305	370	400	460	580	750	860	1060	—	—	—
	415V	[A]	116	146	190	205	265	305	370	400	460	580	750	860	1060	—	—	—
	440V	[A]	116	146	190	205	265	305	370	400	460	580	750	860	1060	—	—	—
	500V	[A]	110	130	156	185	250	290	350	400	460	580	750	860	970	—	—	—
	690V	[A]	66	93	135	165	250	290	315	350	400	500	650	800	970	—	—	—
1000V	[A]	46	60	85	100	113	131	141	155	200	250	300	375	400	—	—	—	
Rated Operational Power, $P_e$	220-240V	[kW]	37	45	55	55	75	90	110	110	132	160	220	250	315	—	—	—
	380-400V	[kW]	55	75	90	110	132	160	200	200	250	315	400	475	560	—	—	—
	415V	[kW]	55	75	90	110	132	160	200	220	250	355	425	500	630	—	—	—
	440V	[kW]	75	90	110	132	160	160	200	220	250	355	450	560	710	—	—	—
	500V	[kW]	75	90	110	132	160	200	250	250	315	400	530	630	710	—	—	—
	690V	[kW]	63	90	132	160	200	250	315	315	355	500	600	800	1000	—	—	—
1000V	[kW]	55	75	110	132	160	185	200	220	280	355	400	555	600	—	—	—	
<b>Load Carrying Capacity per UL/CSA</b>																		
General Purpose Current (enclosed)		[A]	160	200	250	300	350	400	520	550	650	750	900	1350	1650	1210	2100	2700
Rated Power (enclosed), 3-phase	200V	[A]	92	120	150	177	221	285	359	359	414	552	692	954	1030	—	—	—
	230V	[A]	104	130	154	192	248	312	360	360	480	604	722	954	1030	—	—	—
	460V	[A]	96	124	156	180	240	302	361	414	477	590	722	954	1030	—	—	—
	575V	[A]	99	125	144	192	242	289	336	382	472	578	672	944	1050	—	—	—
	200V	[Hp]	30	40	50	60	75	100	125	125	150	200	250	—	—	—	—	—
	230V	[Hp]	40	50	60	75	100	125	150	150	200	250	300	400	450	—	—	—
	460V	[Hp]	75	100	125	150	200	250	300	350	400	500	600	800	900	—	—	—
575V	[Hp]	100	125	150	200	250	300	350	400	500	600	700	1000	1150	—	—	—	
Rated Power (enclosed), with 3 poles in series	260V DC	[A]	160	200	—	—	—	—	—	—	—	—	—	—	—	—	—	—
	300V DC	[A]	—	—	230	250	—	—	—	—	—	—	—	—	—	—	—	—
	340V DC	[A]	—	—	—	—	350	400	520	—	—	—	—	—	—	—	—	—
	600V DC	[A]	—	—	—	—	—	—	—	550	650	750	900	1050	1350	1210	1900	—

100/104-E, 100S-E			116	146	190	205	265	305	370	400	460	580	750	860	1060	1260	2050	2650	
<b>Switching of 3-phase Motors, (50Hz); Ambient temperature 60°C, AC-4</b>																			
Rated Operational Current, $I_e$	230V	[A]	84	103	128	156	195	230	280	307	377	—	—	—	—	—	—	—	
	240V	[A]	84	103	128	156	195	230	280	307	377	—	—	—	—	—	—	—	
	400V	[A]	84	103	128	156	195	230	280	307	377	—	—	—	—	—	—	—	
	415V	[A]	84	103	128	156	195	230	280	307	377	—	—	—	—	—	—	—	
	500V	[A]	84	103	128	156	195	230	280	307	377	—	—	—	—	—	—	—	
	690V	[A]	66	80	93	104	153	162	188	334	350	—	—	—	—	—	—	—	—
	1000V	[A]	40	48	72	85	90	95	100	141	155	—	—	—	—	—	—	—	—
Rated Operational Power, $P_e$	230V	[kW]	25	32	40	50	55	75	90	90	110	—	—	—	—	—	—	—	
	240V	[kW]	25	32	40	50	63	75	90	100	125	—	—	—	—	—	—	—	
	400V	[kW]	45	55	63	80	110	132	160	160	200	—	—	—	—	—	—	—	
	415V	[kW]	45	55	63	90	110	132	160	160	220	—	—	—	—	—	—	—	
	500V	[kW]	55	63	90	110	132	160	200	220	250	—	—	—	—	—	—	—	
	690V	[kW]	63	75	90	100	150	160	185	315	335	—	—	—	—	—	—	—	
	1000V	[kW]	55	63	100	110	125	132	132	200	220	—	—	—	—	—	—	—	
<b>AC-4 at approximately 200,000 operations</b>																			
Rated Operational Current, $I_e$	230V	[A]	38	38	49	55	73	89	100	118	135	—	—	—	—	—	—	—	
	240V	[A]	38	38	49	55	73	89	100	118	135	—	—	—	—	—	—	—	
	400/415V	[A]	38	38	49	55	73	89	100	118	135	—	—	—	—	—	—	—	
	500V	[A]	33	33	37	44	53	59	68	78	89	—	—	—	—	—	—	—	
	690V	[A]	33	33	37	44	53	59	68	78	89	—	—	—	—	—	—	—	
	1000V	[A]	—	—	—	—	—	—	—	—	—	—	—	—	—	—	—	—	—
Rated Operational Power, $P_e$	230V	[kW]	11	11	13	15	22	25	30	37	40	—	—	—	—	—	—	—	
	240V	[kW]	11	11	15	15	22	25	32	37	45	—	—	—	—	—	—	—	
	400V	[kW]	20	20	25	30	40	50	55	63	75	—	—	—	—	—	—	—	
	415V	[kW]	20	20	25	30	40	50	55	63	75	—	—	—	—	—	—	—	
	500V	[kW]	22	22	25	30	37	40	45	55	63	—	—	—	—	—	—	—	
	690V	[kW]	30	30	32	40	50	55	63	75	80	—	—	—	—	—	—	—	
	1000V	[kW]	—	—	—	—	—	—	—	—	—	—	—	—	—	—	—	—	
Max. switching frequency	Ops/h	150	150	150	150	150	150	150	150	60	60	—	—	—	—	—	—	—	
<b>Wye-Delta (60 Hz)</b>																			
	200V	[Hp]	50	60	75	100	125	150	200	200	250	—	—	—	—	—	—	—	
	230V	[Hp]	60	75	100	125	150	200	250	250	350	450	500	—	—	—	—	—	
	460V	[Hp]	125	150	200	250	350	450	500	500	600	800	—	—	—	—	—	—	
	575V	[Hp]	150	200	250	300	450	500	600	600	700	1000	—	—	—	—	—	—	

100/104-E, 100S-E			116	146	190	205	265	305	370	400	460	580	750	860	1060	1260	2050	2650
UL/CSA Elevator Duty	200V	[A]	54	54	77	99	125	149	156	—	—	—	—	—	—	—	—	—
	230V	[A]	54	54	77	99	125	149	156	—	—	—	—	—	—	—	—	—
	460V	[A]	54	54	77	99	125	149	156	—	—	—	—	—	—	—	—	—
	575V	[A]	54	54	77	99	125	149	156	—	—	—	—	—	—	—	—	—
	200V	[Hp]	15	15	20	30	40	40	50	—	—	—	—	—	—	—	—	—
	230V	[Hp]	20	20	25	30	40	50	60	—	—	—	—	—	—	—	—	—
	460V	[Hp]	40	40	60	75	100	100	125	—	—	—	—	—	—	—	—	—
	575V	[Hp]	50	50	75	100	125	150	150	—	—	—	—	—	—	—	—	—
<b>UL/CSA HVAC Applications</b>																		
Definite purpose rating (3-phase)																		
FLA	[A]	116	160	200	250	300	350	520	—	—	—	—	—	—	—	—	—	—
LRA	230V	[A]	700	960	1200	1500	1800	2100	3120	—	—	—	—	—	—	—	—	—
	460V	[A]	580	800	1000	1250	1500	1750	2600	—	—	—	—	—	—	—	—	—
	575V	[A]	470	640	800	1000	1200	1400	2080	—	—	—	—	—	—	—	—	—
AC resistance heating	600V	[A]	160	200	250	300	400	450	520	—	—	—	—	—	—	—	—	—
<b>Star-Delta Starting (50 Hz)</b>																		
Rated Operational Current, $I_e$	≥ 230V	[A]	200	252	329	355	458	528	640	692	796	1004	1299	1489	1835	—	—	—
	≥ 240V	[A]	200	252	329	355	458	528	640	692	796	1004	1299	1489	1835	—	—	—
	400V	[A]	200	252	329	355	458	528	640	692	796	1004	1299	1489	1835	—	—	—
	415V	[A]	200	252	329	355	458	528	640	692	796	1004	1299	1489	1835	—	—	—
	500V	[A]	190	225	233	285	433	502	545	692	796	1004	1299	1385	1680	—	—	—
	690V	[A]	112	161	233	285	433	502	545	606	692	866	1125	1385	1680	—	—	—
	1000V	[A]	—	103	147	173	173	173	173	268	346	433	519	—	—	—	—	—
Rated Operational Power, $P_e$	230V <sup>(1)</sup>	[kW]	55	75	90	110	132	160	200	200	250	315	400	500	560	—	—	—
	240V <sup>(1)</sup>	[kW]	55	75	110	110	132	160	200	200	250	315	400	500	630	—	—	—
	400V <sup>(1)</sup>	[kW]	110	132	160	200	250	250	355	400	400	560	710	800	1000	—	—	—
	415V <sup>(1)</sup>	[kW]	110	132	160	200	250	315	355	400	400	560	800	900	1100	—	—	—
	500V <sup>(1)</sup>	[kW]	132	160	160	200	315	355	355	500	500	710	800	1000	1300	—	—	—
	690V <sup>(1)</sup>	[kW]	90	132	200	250	400	500	500	560	710	800	1100	1400	1700	—	—	—
	1000V <sup>(1)</sup>	[kW]	—	132	200	250	250	250	250	355	500	630	710	—	—	—	—	—

(1) Power ratings at 50 Hz: Preferred values according to IEC 60947-4-1

100/104-E, 100S-E			116	146	190	205	265	305	370	400	460	580	750	860	1060	1260	2050	2650
<b>Switching of Power Transformers, AC-6a (50 Hz)</b>																		
<b>Inrush Current</b>																		
Rated transformer current = n																		
n = 30	≥ 230V	[A]	70	79	111	115	143	143	165	200	252	263	286	430	524	362	—	—
	≥ 240V	[A]	70	79	111	115	143	143	165	200	252	263	286	430	524	362	—	—
	≥ 400V	[A]	70	79	111	115	143	143	165	200	252	263	286	430	524	362	—	—
	≥ 415V	[A]	70	79	111	115	143	143	165	200	252	263	286	430	524	362	—	—
	≥ 500V	[A]	70	79	111	115	143	143	165	200	252	263	286	—	—	362	—	—
	≥ 690V	[A]	70	79	111	115	143	143	165	200	252	263	286	—	—	362	—	—
	≥ 1000V	[A]	—	—	—	—	—	—	—	—	—	—	—	—	—	—	—	—
Apparent Power	230V	[kVA]	28	31	44	46	57	57	66	80	100	105	114	171	209	144	—	—
	240V	[kVA]	29	33	46	48	59	59	69	83	105	109	119	179	218	150	—	—
	400V	[kVA]	48	55	77	80	99	99	114	139	175	182	198	298	363	251	—	—
	415V	[kVA]	50	56	79	82	102	102	117	142	179	187	203	305	372	257	—	—
	500V	[kVA]	61	68	96	100	124	124	143	173	218	228	248	—	—	314	—	—
	690V	[kVA]	84	94	133	137	171	171	197	239	301	314	342	—	—	433	—	—
	1000V	[kVA]	—	—	—	—	—	—	—	—	—	—	—	—	—	—	—	—
n = 20	≥ 690V	[A]	105	119	167	173	215	215	248	300	378	395	429	—	—	543	—	—
n = 15	≥ 690V	[A]	140	158	222	230	286	286	330	400	504	526	572	—	—	724	—	—
<b>60 Hz Peak Inrush/peak rated transformer current</b>																		
n = 30	≥ 660V	[A]	70	79	111	115	143	143	165	200	252	263	286	430	524	362	—	—
Apparent Power	200V	[kVA]	24	27	38	40	50	50	57	69	87	91	99	149	182	125	—	—
	208V	[kVA]	25	28	40	41	52	52	59	72	91	95	103	155	189	130	—	—
	240V	[kVA]	29	33	46	48	59	59	69	83	105	109	119	179	218	150	—	—
	480V	[kVA]	58	66	92	96	119	119	137	166	210	219	238	357	436	301	—	—
	600V	[kVA]	73	82	115	120	149	149	171	208	262	273	297	447	545	376	—	—
	660V	[kVA]	80	90	127	131	163	163	189	229	288	301	327	492	599	414	—	—
n = 20	≥ 660V	[A]	105	119	167	173	215	215	248	300	378	395	429	645	786	543	—	—
Apparent Power	200V	[kVA]	36	41	58	60	74	74	86	104	131	137	149	223	272	188	—	—
	208V	[kVA]	38	43	60	62	77	77	89	108	136	142	155	232	283	196	—	—
	240V	[kVA]	44	49	69	72	89	89	103	125	157	164	178	268	327	226	—	—
	480V	[kVA]	87	99	139	144	179	179	206	249	314	328	357	536	653	451	—	—
	600V	[kVA]	109	124	174	180	223	223	258	312	393	410	446	670	817	564	—	—
	660V	[kVA]	120	136	191	198	246	246	284	343	432	452	490	737	899	621	—	—
n = 15	≥ 660V	[A]	140	158	222	230	286	286	330	400	504	526	572	860	1048	724	—	—
Apparent Power	200V	[kVA]	48	55	77	80	99	99	114	139	175	182	198	298	363	251	—	—
	208V	[kVA]	50	57	80	83	103	103	119	144	182	190	206	310	378	261	—	—
	240V	[kVA]	58	66	92	96	119	119	137	166	210	219	238	357	436	301	—	—
	480V	[kVA]	116	131	185	191	238	238	274	333	419	437	476	715	871	602	—	—
	600V	[kVA]	145	164	231	239	297	297	343	416	524	547	594	894	1089	752	—	—
	660V	[kVA]	160	181	254	263	327	327	377	457	576	601	654	983	1198	828	—	—

100/104-E, 100S-E			116	146	190	205	265	305	370	400	460	580	750	860	1060	1260	2050	2650
<b>Switching of 3-phase Capacitors, AC-6b (50 Hz)</b>																		
Single capacitor 40 °C	230V	[kVar]	40	50	60	75	85	100	110	120	140	170	220	250	300	—	—	—
	240V	[kVar]	40	50	60	75	85	100	110	120	140	170	220	250	300	—	—	—
	400V	[kVar]	75	90	110	130	145	165	200	210	240	285	400	450	500	—	—	—
	415V	[kVar]	75	90	110	130	145	165	200	210	240	285	400	450	500	—	—	—
	500V	[kVar]	83	110	140	160	180	210	240	260	325	350	490	550	600	—	—	—
	690V	[kVar]	80	110	135	170	200	240	280	300	325	440	600	650	800	—	—	—
	1000V	[kVar]	—	100	140	150	155	160	170	250	300	350	450	—	—	—	—	—
Single capacitor 55 °C	230V	[kVar]	40	50	60	75	85	100	110	120	140	170	220	250	300	—	—	—
	240V	[kVar]	40	50	60	75	85	100	110	120	140	170	220	250	300	—	—	—
	400V	[kVar]	75	90	110	130	145	165	200	210	240	285	400	450	500	—	—	—
	415V	[kVar]	75	90	110	130	145	165	200	210	240	285	400	450	500	—	—	—
	500V	[kVar]	83	110	140	160	180	210	240	260	325	350	490	550	600	—	—	—
	690V	[kVar]	80	110	135	170	200	240	280	300	325	440	600	650	800	—	—	—
	1000V	[kVar]	—	100	140	150	155	160	170	250	300	350	450	—	—	—	—	—
Single capacitor 70 °C	230V	[kVar]	35	42	45	57	70	85	100	105	120	160	190	230	280	—	—	—
	240V	[kVar]	35	42	45	57	70	85	100	105	120	160	190	230	280	—	—	—
	400V	[kVar]	65	74	83	105	135	155	180	195	225	275	370	430	480	—	—	—
	415V	[kVar]	65	74	83	105	135	155	180	195	225	275	370	430	480	—	—	—
	500V	[kVar]	78	96	102	130	165	196	220	241	300	340	435	530	570	—	—	—
	690V	[kVar]	75	110	135	160	200	240	260	300	325	440	600	630	750	—	—	—
	1000V	[kVar]	—	95	120	130	140	150	160	220	270	300	400	—	—	—	—	—
<b>60 Hz Single Capacitor (cULus)</b>																		
Single capacitor 40 °C	208V	[kVar]	33	41	50	67	83	100	125	119	142	178	214	—	346	—	—	—
	240V	[kVar]	38	48	57	77	95	115	144	137	164	205	247	—	398	—	—	—
	480V	[kVar]	75	100	125	150	200	250	300	274	329	411	494	—	832	—	—	—
	600V	[kVar]	100	125	150	200	250	300	350	343	410	514	618	—	1040	—	—	—
<b>Switching of Lamps</b>																		
Gas discharge lamps AC-5a	open	[A]	116	146	190	205	265	305	370	400	460	580	750	877	1072	812	1332	1722
UL Ballast Ratings		[A]	160	200	250	300	400	450	520	—	—	—	—	—	—	—	—	—
Filament AC-5b	230/240V	[A]	116	146	190	205	265	305	370	400	460	580	750	877	1072	812	1332	1722

100/104-E, 100S-E			116	146	190	205	265	305	370	400	460	580	750	860	1060	1260	2050	2650		
<b>Switching of DC Loads</b>																				
Non-inductive or slightly inductive loads or resistance furnaces DC-1 at 60 °C																				
1 pole	≤72V	[A]	160	200	250	350	400	500	520	600	700	800	1050	1350	1650	1250	2050	—	—	
	90V	[A]	160	200	250	350	400	500	520	—	—	—	—	—	—	—	—	—	—	
	100V	[A]	—	—	250	350	400	500	520	—	—	—	—	—	—	—	—	—	—	
	110V	[A]	—	—	—	—	400	500	520	600	700	800	1050	1350	1650	1250	2050	—	—	
2 poles in series	≤72V	[A]	160	200	250	350	400	500	520	600	700	800	1050	1350	1650	1250	2050	—	—	
	110V	[A]	160	200	250	350	400	500	520	600	700	800	1050	1350	1650	1250	2050	—	—	
	175V	[A]	160	200	250	350	400	500	520	600	700	800	1050	—	—	—	—	—	—	
	200V	[A]	—	—	250	350	400	500	520	600	700	800	1050	—	—	—	—	—	—	
3 poles in series	≤72V	[A]	160	200	250	350	400	500	520	600	700	800	1050	1350	1650	1250	2050	—	—	
	110V	[A]	160	200	250	350	400	500	520	600	700	800	1050	1350	1650	1250	2050	—	—	
	175V	[A]	160	200	250	350	400	500	520	600	700	800	1050	1350	1650	1250	2050	—	—	
	220V	[A]	160	200	250	350	400	500	520	600	700	800	1050	1350	1650	1250	2050	—	—	
	260V	[A]	160	200	250	350	400	500	520	600	700	800	1050	1350	1650	1250	2050	—	—	
	300V	[A]	—	—	250	350	400	500	520	600	700	800	1050	1350	1650	1250	2050	—	—	
	340V	[A]	—	—	—	—	400	500	520	600	700	800	1050	1350	1650	1250	2050	—	—	
	600V	[A]	—	—	—	—	—	—	—	600	700	800	1050	1350	1650	1250	2050	—	—	
3 poles in series	24V	[A]	145	160	250	275	350	400	450	600	700	800	1050	—	—	—	—	—	—	
	48/60V	[A]	145	160	250	275	350	400	450	600	700	800	1050	—	—	—	—	—	—	
	110V	[A]	145	160	250	275	350	400	450	600	700	800	1050	—	—	—	—	—	—	
	220V	[A]	145	160	250	275	350	400	450	600	700	800	1050	—	—	—	—	—	—	
	440V	[A]	—	—	—	—	—	—	—	600	700	800	1050	—	—	—	—	—	—	
Series-wound Motors—Starting, reverse current breaking, reversing, stepping DC-5, 60 °C																				
3 poles in series	24V	[A]	145	160	250	275	350	400	450	600	700	800	1050	—	—	—	—	—	—	
	48/60V	[A]	145	160	250	275	350	400	450	600	700	800	1050	—	—	—	—	—	—	
	110V	[A]	145	160	250	275	350	400	450	600	700	800	1050	—	—	—	—	—	—	
	220V	[A]	145	160	250	275	350	400	450	600	700	800	1050	—	—	—	—	—	—	
	440V	[A]	—	—	—	—	—	—	—	600	700	800	1050	—	—	—	—	—	—	
Short Time Withstand $I_{CW}$ 40 °C																				
	1 s	[A]	1300	1460	1900	2050	2650	3050	3700	4600	4600	7000	7000	10000	12000	8000	12000	12000	12000	
	10 s	[A]	928	1168	1520	1640	2120	2440	2960	4400	4400	6400	6400	8000	10000	7200	10000	10000	10000	
	30 s	[A]	536	674	878	947	1224	1409	1709	3100	3100	4500	4500	6000	7500	5200	7500	7500	7500	
	1 min	[A]	379	477	621	670	865	996	1208	2500	2500	3500	3500	4500	5500	4000	5500	5500	5500	
	15 min	[A]	160	225	275	350	400	500	600	840	840	1300	1300	1600	2200	1500	2200	2800	2800	
<b>Resistance and Power Dissipation</b>																				
Main current circuit resistance	[mΩ]	0.469	0.454	0.198	0.204	0.200	0.200	0.200	0.083	0.086	0.050	0.045	0.044	0.029	0.050	0.030	0.028	—	—	
Power dissipation per pole at $I_e$ AC-1, 400V	[W]	12	23	15	25	32	50	72	30	42	32	50	80	80	80	125	200	—	—	
Power dissipation per pole at $I_e$ AC-3/400V	[W]	6	10	7	8	14	19	27	16	21	17	28	50	50	—	—	—	—	—	
Total power dissipation at:																				
$I_e$ AC-3, 400V; AC/DC control (120-250V)	[W]	21	33	23.5	26.5	46.5	61.5	85.5	53	68	56	89	171	171	—	—	—	—	—	
<b>Maximum Switching Frequency</b>																				
AC-1	ops/hr	300					300					60	300	60	15					
AC-3	ops/hr	300					300					60	—	—	—					
AC-2, AC-4	ops/hr	150					60					60	—	—	—					

100/104-E, 100S-E		116	146	190	205	265	305	370	400	460	580	750	860	1060	1260	2050	2650
<b>Weight</b>																	
AC/DC (Electronic) with bar connections	kg (lbs.)	1.50 (3.3)	1.50 (3.3)	3 (6.6)	3 (6.6)	4.64 (10.2)	4.64 (10.2)	4.64 (10.2)	12 (26.4)	12 (26.4)	15 (33)	15 (33)	34 (74.8)	35 (77)	16 (35.2)	35 (77)	45 (99)
with built-in cable clamps	kg (lbs.)	1.75 (3.85)	1.75 (3.85)	—	—	—	—	—	—	—	—	—	—	—	—	—	—

100/104-E, 100S-E		116	146	190	205	265	305	370	400	460	580	750	860	1060	1260	2050	2650
-------------------	--	-----	-----	-----	-----	-----	-----	-----	-----	-----	-----	-----	-----	------	------	------	------

**Short Circuit Coordination (Max. Fuse or Circuit Breaker Rating) Per IEC 60947-4-1**

<b>DIN Fuses - gG</b>	Type "2" (400V)	[A]	100 kA Available Fault Current														
			250	250	315	315	400	500	630	630	630	800	800	1000	1250	—	—
<b>MCCB</b>	Type "2" (690V)	[A]	80 kA Available Fault Current														
			160	200	315	315	400	425	500	500	630	800	800	1000	1600	—	—
<b>MCCB</b>	Type "2" (400V)	[A]	70 kA Available Fault Current														
			160	160	320	320	400	630	630	630	630	800	1000	1600	1600	—	—

**Short Circuit Current Rating (Max. Fuse or Circuit Breaker Rating) Per UL 60947 and CSA 22.2 No. 14 (contactor and fuses or circuit breaker only)**











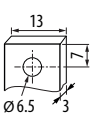
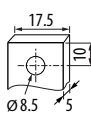
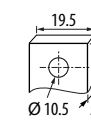
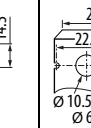
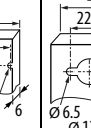
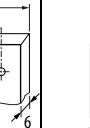

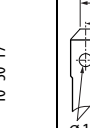
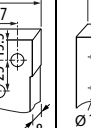
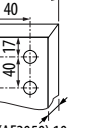

<b>UL Class RK5 Fuses</b>	Type 1 Combination (600V)	[A]	10 kA Available Fault Current															
			250	250	400	400	—	—	—	—	—	—	—	—	—	—	—	—
<b>UL Class L Fuses</b>	Type 1 Combination (600V)	[A]	18 kA Available Fault Current															
			—	—	—	—	800	800	800	1000	—	—	—	—	—	—	—	—
	Type 1 Combination (600V)	[A]	30 kA Available Fault Current															
			—	—	—	—	—	—	—	—	1000	—	—	—	—	—	—	—
<b>UL Class J and CSA HRCI-J Fuses</b>	Type 1 Combination (600V)	[A]	85 kA Available Fault Current															
			—	—	—	—	—	—	—	—	—	—	—	—	—	—	—	—
	Type 1 Combination (600V)	[A]	100 kA Available Fault Current															
			250	250	400	400	600	600	600	600	600	—	—	—	—	—	—	—
<b>UL Class L Fuses</b>	Type 2 Combination (600V)	[A]	200	200	400	400	600	600	600	600	600	—	—	—	—	—	—	—
	Type 1 Combination (600V)	[A]	100 kA Available Fault Current															
<b>UL Class L Fuses</b>	Type 2 Combination (600V)	[A]	—	—	—	—	—	—	—	—	800	800	1200	1200	—	—	1600	—
	Type 1 Combination (600V)	[A]	100 kA Available Fault Current															
<b>UL Inverse-Time Circuit</b>	Type 1 Combination (480V)	[A]	—	—	—	—	—	—	—	—	—	800	800	1200	1200	—	—	1600
	Type 2 Combination (480V)	[A]	42 kA Available Fault Current															
			—	—	—	—	—	—	—	—	—	—	—	—	—	—	—	—
	Type 1 Combination (480V)	[A]	65 kA Available Fault Current															
			250	250	400	400	800	800	800	800	800	800	800	800	800	—	—	—
	Type 1 Combination (480V)	[A]	84 kA Available Fault Current															
			—	—	—	—	—	—	—	—	800	800	—	—	—	—	—	—
	Type 1 Combination (480V)	[A]	89 kA Available Fault Current															
			—	—	—	—	—	—	—	—	—	800	800	—	—	—	—	—
	Type 1 Combination (480V)	[A]	100 kA Available Fault Current															
			250	250	400	400	800	800	800	—	—	—	—	—	—	—	—	—
	Type 2 Combination (600V)	[A]	25 kA Available Fault Current															
			250	250	—	—	—	—	—	—	—	—	—	—	—	—	—	—
	Type 2 Combination (600V)	[A]	35 kA Available Fault Current															
		—	—	400	400	800	800	800	800	800	800	800	800	—	—	—	—	
Type 1 Combination (600V)	[A]	42 kA Available Fault Current																
		—	—	—	—	800	800	800	800	800	800	800	800	—	—	—	—	
Type 1 Combination (600V)	[A]	50 kA Available Fault Current																
		250	250	—	—	—	—	—	—	—	—	—	—	—	—	—	—	
Type 1 Combination (600V)	[A]	65 kA Available Fault Current																
		—	—	400	400	400	400	400	—	—	—	—	—	—	—	—	—	

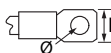

**Coil Data**

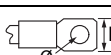

100/104-E, 100S-E			116	146	190	205	265	305	370	400	460	580	750	860	1060	1260	2050	2650
<b>Operating Limits</b>																		
50/60 Hz	pick-up	[x Us]	0.85...1.1															
	dropout	[x Us]	0.55															
DC control	pick-up	[x Us]	0.80...1.1															
	dropout	[x Us]	0.55															
24...60V AC	pick-up	[VA]	225	165	475	—	—	—	—	—	—	—	—	—	—	—	—	—
	hold-in	[VA]	5.5	6	8.5	—	—	—	—	—	—	—	—	—	—	—	—	—
48...130V AC	pick-up	[VA]	170	175	340	1215	1100	—	1100	—	—	—	—	—	—	—	—	—
	hold-in	[VA]	4	4	17	12	12	—	12	—	—	—	—	—	—	—	—	—
100...250V AC	pick-up	[VA]	130	220	385	955	880	2450	880	2450	—	—	—	—	—	—	—	—
	hold-in	[VA]	6	7	17.5	12	12	48	12	48	—	—	—	—	—	—	—	—
250...500V AC	pick-up	[VA]	205	185	420	950	985	—	985	—	—	—	—	—	—	—	—	—
	hold-in	[VA]	16	16	21	12	12	—	12	—	—	—	—	—	—	—	—	—
24...60V DC	pick-up	[W]	210	205	400	900	785	—	785	—	—	—	—	—	—	—	—	—
	hold-in	[W]	2.5	2.5	3.5	5	5.5	—	5.5	—	—	—	—	—	—	—	—	—
48...130V DC	pick-up	[W]	130	130	360	1150	1020	—	1020	—	—	—	—	—	—	—	—	—
	hold-in	[W]	2.5	2.5	2.5	5	5	—	5	—	—	—	—	—	—	—	—	—
100...250V DC	pick-up	[W]	135	190	410	895	880	2290	880	2290	—	—	—	—	—	—	—	—
	hold-in	[W]	3	2.5	4.5	5	5	20.5	5	20.5	—	—	—	—	—	—	—	—
250...500V DC	pick-up	[W]	205	190	600	885	910	—	910	—	—	—	—	—	—	—	—	—
	hold-in	[W]	4	4	4.7	7.5	7.5	—	7.5	—	—	—	—	—	—	—	—	—
<b>Operating Times</b>																		
AC or DC	closing delay	[ms]	20...55	25...60	30...60	50...120	50...120	50...80	50...120	50...80	—	—	—	—	—	—	—	—
	opening delay	[ms]	40...70	45...80	45...80	33...70	33...70	35...55	33...70	35...55	—	—	—	—	—	—	—	—
With PLC Interface	closing delay	[ms]	20...31	25...45	25...45	40...60	40...90	40...65	40...90	40...65	—	—	—	—	—	—	—	—
	opening delay	[ms]	24...34	25...45	25...45	10...30	10...30	10...30	10...30	10...30	—	—	—	—	—	—	—	—

**Cross Sections, Screw Type Terminals**

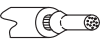
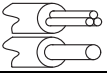
100/104-E, 100S-E		116	146	190	205	265	305	370	400	460	580	750	860	1060	1260	2050	2650	
<b>Main Terminals</b>																		
<b>Conductor Cross Sections — Main Contacts (Terminal type)</b>																		
	(1) conductor	[mm <sup>2</sup> ]	10...95	16...300	16...400	—	—	—	—	—	—	—	—	—	—	—	—	—
	Clamp type		100-ECL146	100-ETL205	100-ETL370	—	—	—	—	—	—	—	—	—	—	—	—	—
	Recommended torque	[N·m]	8	34	42	—	—	—	—	—	—	—	—	—	—	—	—	—
	(2) conductors	[mm <sup>2</sup> ]	10...95	—	16...500	70...500	70...500	70...500	120...500	70...750	—	—	—	—	—	—	—	—
	Clamp type		100-ECL146	—	100-ETL370B	100-ETL580	100-ETL750	100-ETL860	100-ETL1060	—	—	—	—	—	—	—	—	—
	Recommended torque	[N·m]	8	—	42	31	43	43	43	57	—	—	—	—	—	—	—	—
	(3) conductors	[mm <sup>2</sup> ]	—	—	—	—	70...500	120...500	70...750	70...500	—	—	—	—	—	—	—	—
	Clamp type		—	—	—	—	100-ETL750	100-ETL860	100-ETL1060	100-ETL750	—	—	—	—	—	—	—	—
	Recommended torque	[N·m]	—	—	—	—	43	43	57	43	—	—	—	—	—	—	—	—
	(4) conductors	[mm <sup>2</sup> ]	—	—	—	—	—	120...500	70...750	—	—	—	—	—	—	—	—	—
	Clamp type		—	—	—	—	—	100-ETL860	100-ETL1060	—	—	—	—	—	—	—	—	—
	Recommended torque	[N·m]	—	—	—	—	—	43	57	—	—	—	—	—	—	—	—	—
	(6) conductors	[mm <sup>2</sup> ]	—	—	—	—	—	—	70...750	—	—	—	—	—	—	—	—	—
	Clamp type		—	—	—	—	—	—	100-ETL1060B	—	—	—	—	—	—	—	—	—
	Recommended torque	[N·m]	—	—	—	—	—	—	57	—	—	—	—	—	—	—	—	—
	L max.	[mm]	22	24	32	47	50	100		50	100							
	Ø min.	[mm]	6	8	10	10	12	12		12	12							
	Recommended torque	[N·m]	9	18	28	35	45	45		45	45							
<b>Cross section per UL/CSA</b>																		
	(1) conductor	[AWG]	3...3/0	6...300 <sup>(1)</sup>	4...400 <sup>(1)</sup>	—	—	—	—	—	—	—	—	—	—	—	—	—
	Clamp type		100-ECL146	100-ETL205	100-ETL370	—	—	—	—	—	—	—	—	—	—	—	—	—
	Recommended torque	[lb-in]	80	300	375	—	—	—	—	—	—	—	—	—	—	—	—	—
	(2) conductors	[AWG]	6...3/0	—	4...500 <sup>(1)</sup>	2/0...500 <sup>(1)</sup>	2/0...500 <sup>(1)</sup>	4/0...500 <sup>(1)</sup>	1/0...750 <sup>(1)</sup>	2/0...500 <sup>(1)</sup>	—	—	—	—	—	—	—	—
	Clamp type		100-ECL146	—	100-ETL370B	100-ETL580	100-ETL750	100-ETL860	100-ETL1060	100-ETL750	—	—	—	—	—	—	—	—
	Recommended torque	[lb-in]	80	—	375	275	375	375	500	375	—	—	—	—	—	—	—	—
	(3) conductors	[AWG]	—	—	—	—	2/0...500 <sup>(1)</sup>	4/0...500 <sup>(1)</sup>	1/0...750 <sup>(1)</sup>	2/0...500 <sup>(1)</sup>	—	—	—	—	—	—	—	—
	Clamp type		—	—	—	—	100-ETL750	100-ETL860	100-ETL1060	100-ETL750	—	—	—	—	—	—	—	—
	Recommended torque	[lb-in]	—	—	—	—	375	375	500	375	—	—	—	—	—	—	—	—
	(4) conductors	[AWG]	—	—	—	—	—	4/0...500 <sup>(1)</sup>	1/0...750 <sup>(1)</sup>	—	—	—	—	—	—	—	—	—
	Clamp type		—	—	—	—	—	100-ETL860	100-ETL1060	—	—	—	—	—	—	—	—	—
	Recommended torque	[lb-in]	—	—	—	—	—	375	500	—	—	—	—	—	—	—	—	—
	(6) conductors	[AWG]	—	—	—	—	—	—	1/0...750 <sup>(1)</sup>	—	—	—	—	—	—	—	—	—
	Clamp type		—	—	—	—	—	—	100-ETL1060B	—	—	—	—	—	—	—	—	—
	Recommended torque	[lb-in]	—	—	—	—	—	—	500	—	—	—	—	—	—	—	—	—
	L max.	[in]	0.866	0.945	1.26	1.85	1.97	3.94		1.97	3.94							
	Ø min.	[in]	0.236	0.315	0.394	0.394	0.472	0.472		0.472	0.472							
	Recommended torque	[lb-in]	80	160	248	310	398	398		398	398							

100/104-E, 100S-E		116	146	190	205	265	305	370	400	460	580	750	860	1060	1260	2050	2650
<b>Conductor Cross Sections — Coil Terminals (Terminal type)</b>																	
	(1) conductor	[mm <sup>2</sup> ]															
	(2) conductors	[mm <sup>2</sup> ]															
	(1) conductor	[mm <sup>2</sup> ]															
	(2) conductors	[mm <sup>2</sup> ]															
Recommended torque		[N·m]															
Cross section per UL/CSA		[AWG]															
Recommended torque		[lb·in]															

(1) MCM

			Auxiliary contact for 100/104-E, 100S-E		
			Standard 100-ES1/2*	Standard 100-ES3/4*	Low Power 100-ES*-B*
<b>Switching of AC Loads</b>					
Rated Insulation voltage $U_i$			690V	690V	250V
Rated operational voltage $U_e$			690V	690V	125V
Rated impulse withstand voltage $U_{imp}$			6kV	6kV	1.5kV
AC-12 $I_{th}$	at 40 °C	[A]	16	16	0.1
	at 60 °C	[A]	—	—	—
AC-14 at rated voltage of	24V	[A]	—	—	0.1
	42/48V	[A]	—	—	0.1
	120V	[A]	—	—	0.1
AC-15 at rated voltage of	24V	[A]	6	6	—
	42/48V	[A]	6	6	—
	120V	[A]	6	6	—
	230V	[A]	4	4	—
	240V	[A]	4	4	—
	400V	[A]	3	3	—
	415V	[A]	3	3	—
	500V	[A]	2	2	—
690V	[A]	2	2	—	
<b>Switching of DC Loads</b>					
DC-12 L/R < 1 ms resistive loads at	24V DC	[A]	—	—	0.1
	48V DC	[A]	—	—	0.1
	110V DC	[A]	—	—	0.1
	220V DC	[A]	—	—	—
	440V DC	[A]	—	—	—
DC-14 L/R < 15 ms inductive loads with economy resistor in series at	24V DC	[A]	—	—	—
	48V DC	[A]	—	—	—
	110V DC	[A]	—	—	—
	220V DC	[A]	—	—	—
	440V DC	[A]	—	—	—
DC-13 switching electromagnets at	24V DC	[A]	3	6	—
	48V DC	[A]	1.5	2.8	—
	110V DC	[A]	0.55	0.55	—
	220V DC	[A]	0.3	0.3	—
	440V DC	[A]	—	—	—
<b>Fuse gG</b>					
Short-circuit protection with no welding of contacts per IEC 60947-5-2		[A]	10	10	0.1
		[A]	10	10	0.1
Protective Separation per IEC 60947-1, Annex N					

			Auxiliary contact for 100/104-E, 100S-E		
			Standard 100-ES1/2*	Standard 100-ES3/4*	Low Power 100-ES*-B*
Min. switching capacity at 24V IEC 60947-5-4	[mA]	50	50	—	
Min. switching capacity at 3V IEC 60947-5-4	[mA]	—	—	1	
<b>Load Carrying Capacity per UL/CSA</b>					
Rated voltage	AC	[V]	600	600	125
Continuous rating	40 °C	[A]	10	10	0.1
Switching capacity	AC		A 600	A 600	—
Rated voltage	DC	[V]	250	250	125
Continuous rating	40 °C	[A]	2.5	2.5	0.1
Switching capacity	DC		P 600	Q 300	—

## Life-Load Curves

### 3-pole contactors — Electrical durability

**Figure 21 - Electrical durability for AC-1 utilization category -  $U_e \leq 690V$**

Switching non-inductive or slightly inductive loads. The breaking current  $I_c$  for AC-1 is equal to the rated operational current of the load.

Ambient temperature (see [page 81](#)) and maximum electrical switching frequency (see [page 87](#)).

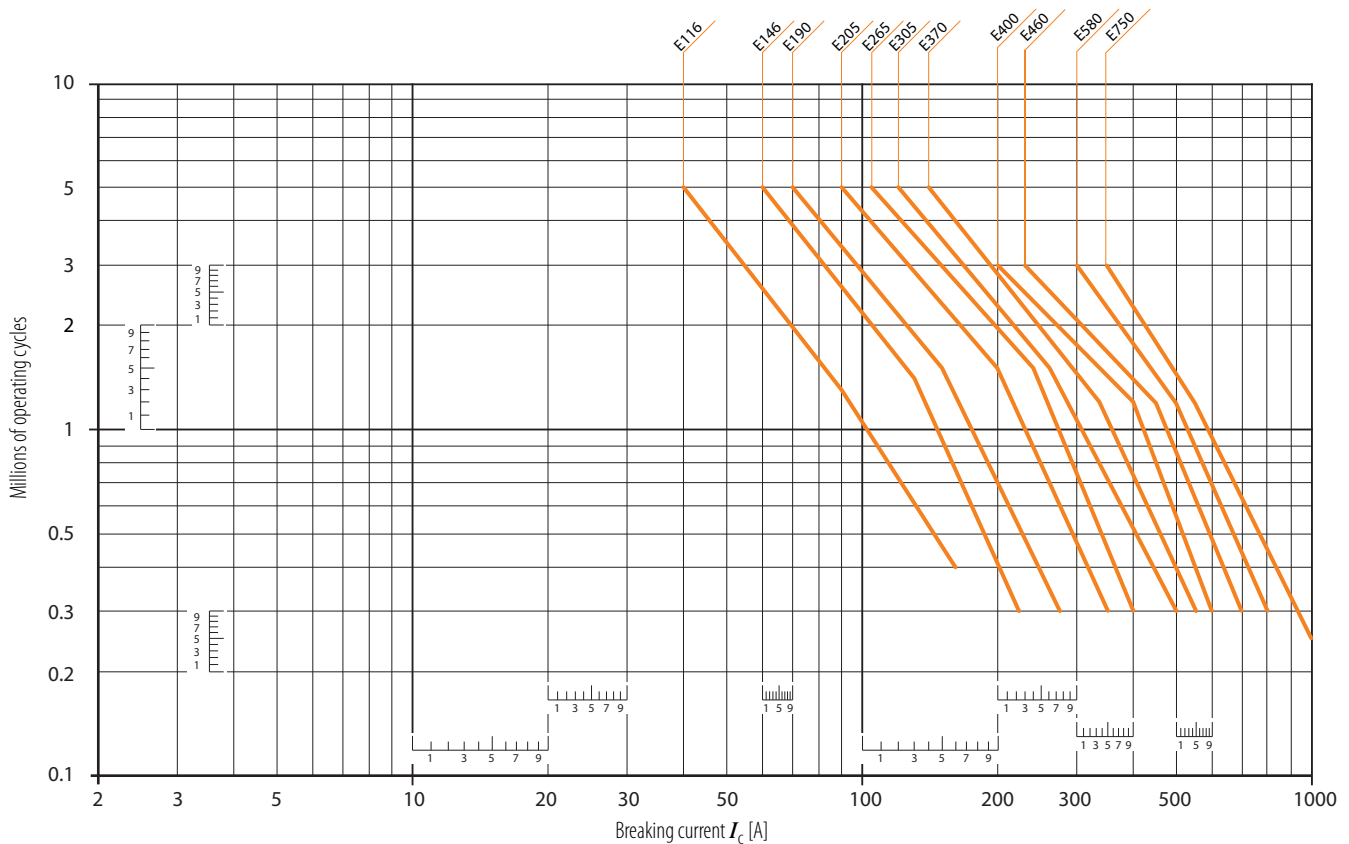

**Cat. Nos. 100-E860, -E1060:** The electrical durability at the rated current is 50,000 operating cycles.

**Figure 22 - Electrical durability for AC-3 utilization category -  $U_e \leq 440V$**

Switching cage motors: starting and switching off running motors. The breaking current  $I_c$  for AC-3 is equal to the rated operational current  $I_e$  ( $I_e$  = motor full load current).

For ambient temperature (see [page 81](#)) and maximum electrical switching frequency (see [page 87](#)).

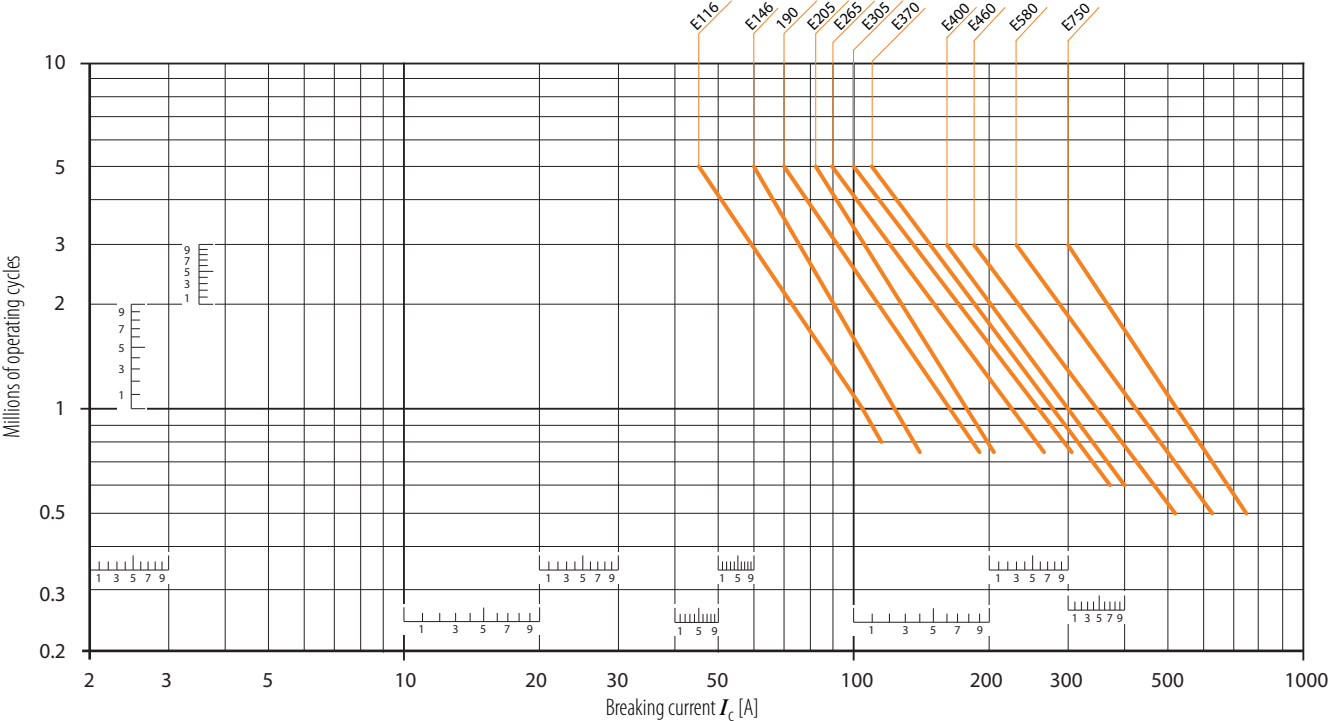

**Cat. Nos. 100-E860, -E1060:** The electrical durability at the rated current is 50,000 operating cycles.

**Figure 23 - Electrical durability for AC-3 utilization category -  $440V < U_e \leq 690V$**

Switching cage motors: starting and switching off running motors. The breaking current  $I_c$  for AC-3 is equal to the rated operational current  $I_e$  ( $I_e$  = motor full load current).

For ambient temperature (see [page 81](#)) and maximum electrical switching frequency (see [page 87](#)).

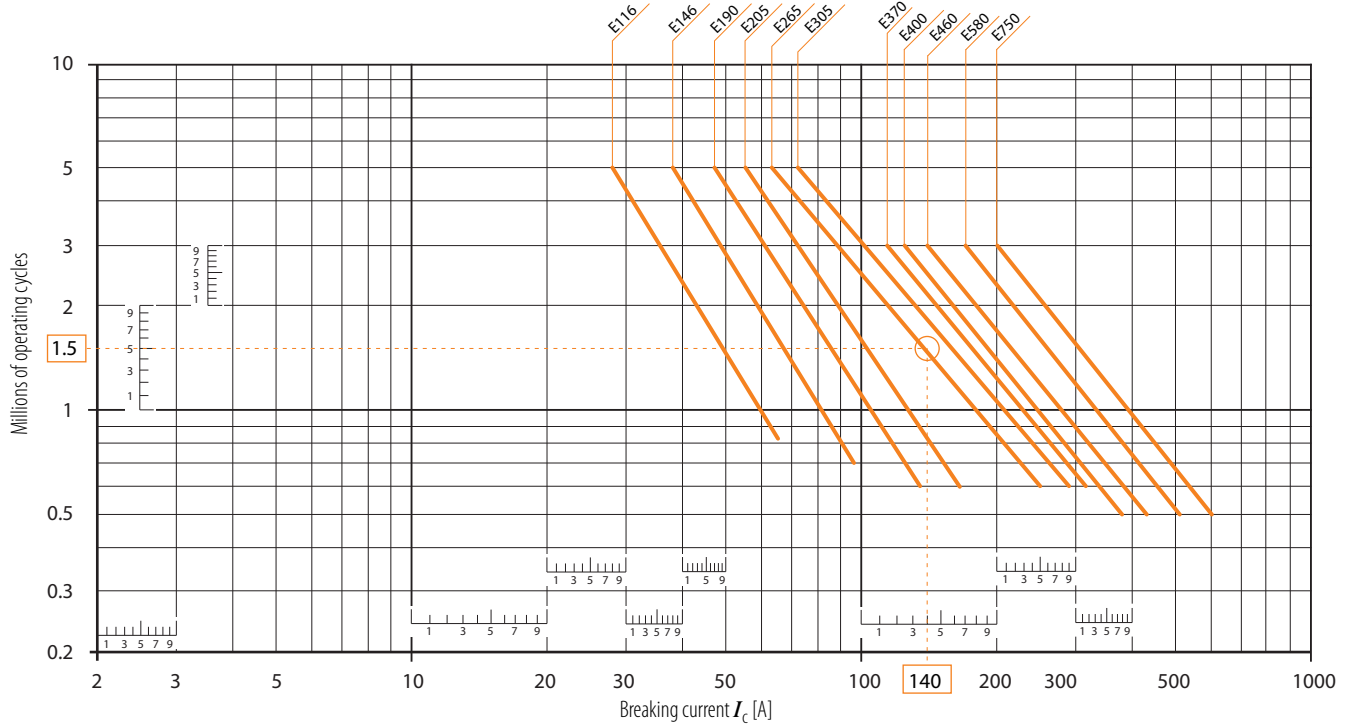

**Cat. Nos. 100-E860, -E1060:** The electrical durability at the rated current is 50,000 operating cycles.

**Figure 24 - Electrical durability for AC-2 or AC-4 utilization category -  $U_e \leq 440V$**

Switching cage motors: starting, reverse operation and step-by-step operation. The breaking current  $I_C$  is equal to  $2.5 \times I_e$  for AC-2 and  $6 \times I_e$  for AC-4,

keeping in mind that  $I_e$  is the motor rated operational current ( $I_e =$  motor full-load current). For maximum electrical switching frequency (see [page 87](#)).

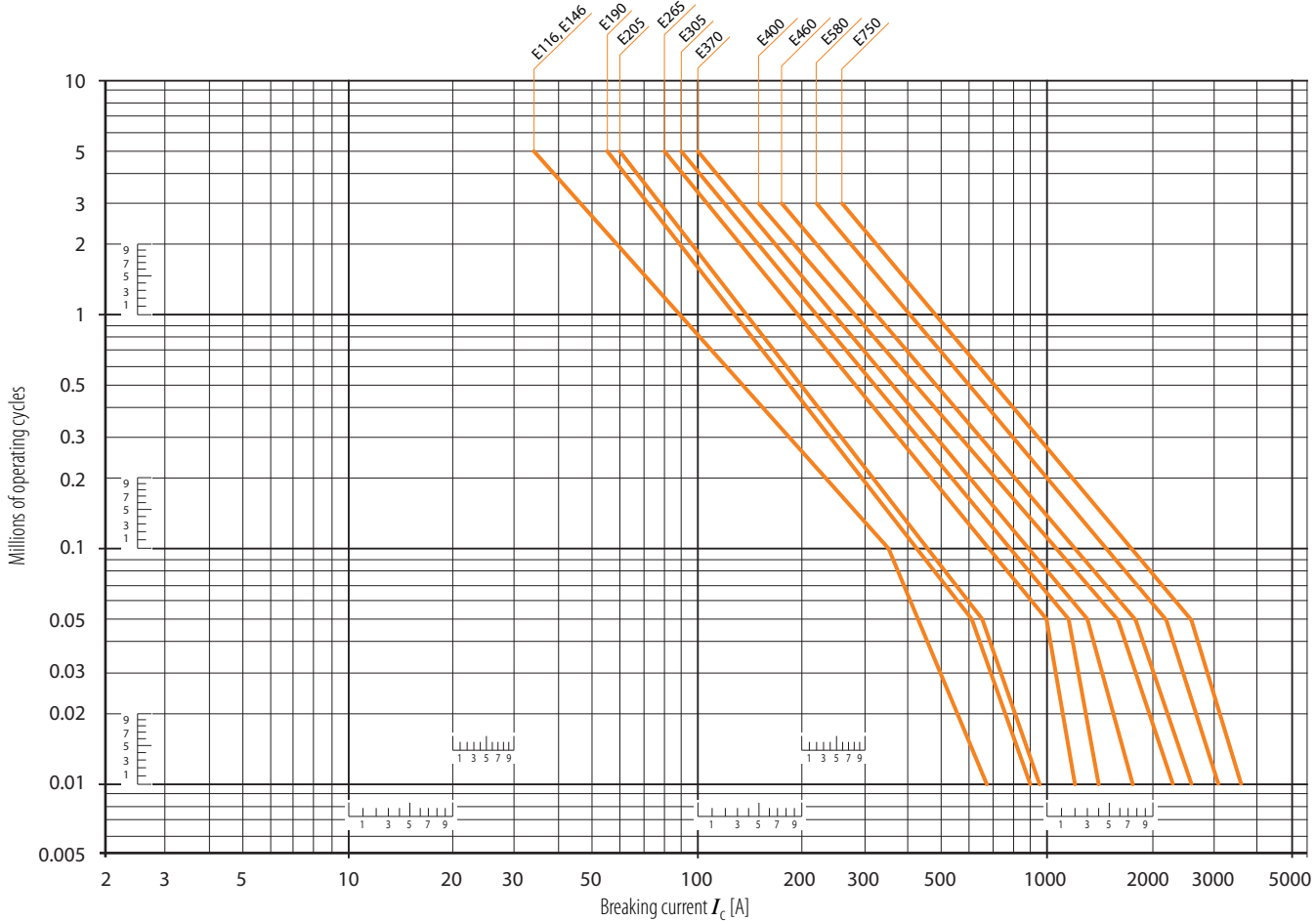

**Figure 25 - Electrical durability for AC-2 or AC-4 utilization category -  $440V < U_e \leq 690V$**

Switching cage motors: starting, reverse operation and step-by-step operation. The breaking current  $I_c$  is equal to  $2.5 \times I_e$  for AC-2 and  $6 \times I_e$  for AC-4, keeping in mind that  $I_e$  is the motor rated operational current ( $I_e$  = motor full load current). For maximum electrical switching frequency (see [page 87](#)).

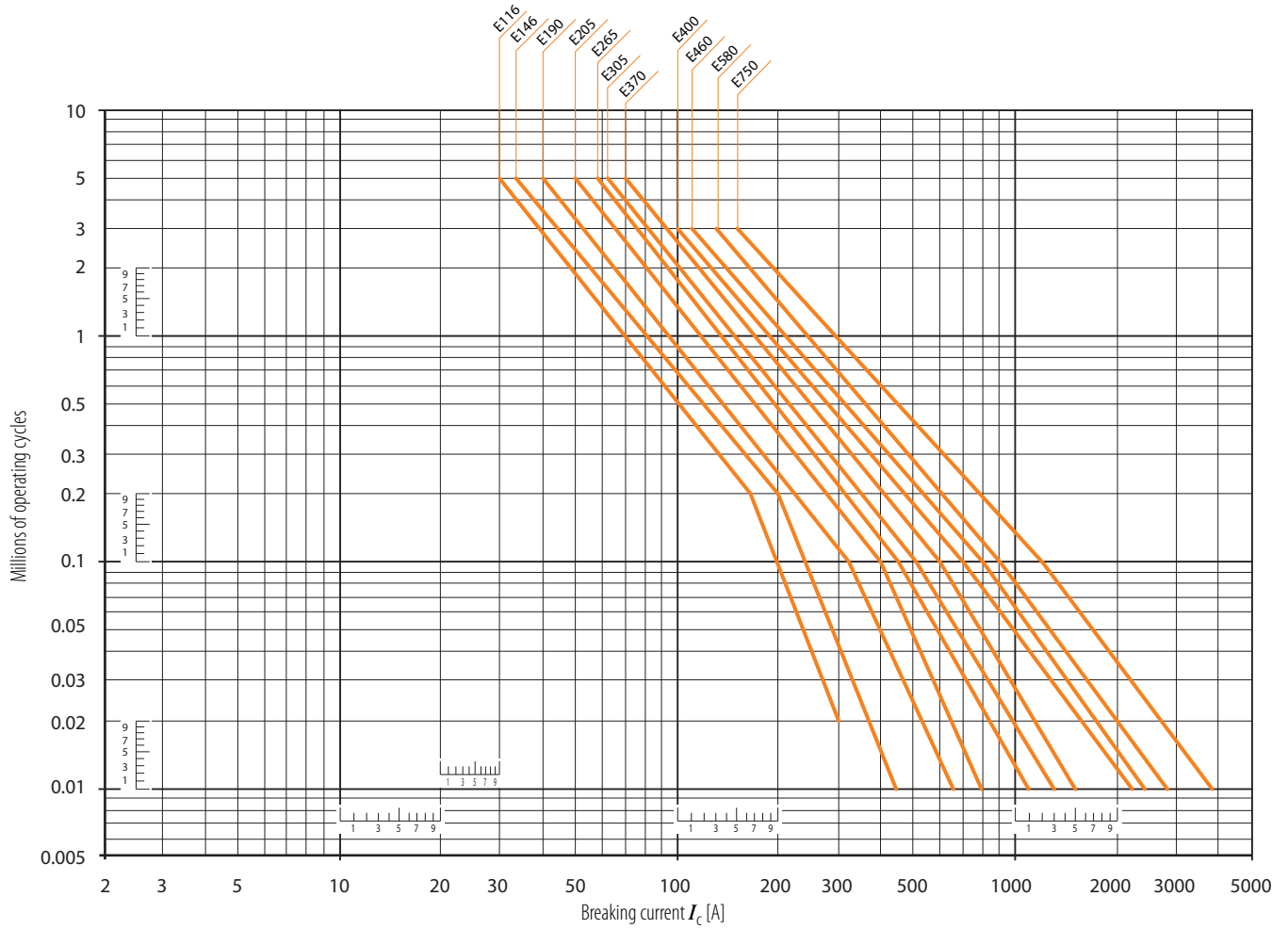



# Approximate Dimensions

Dimensions are shown in millimeters (inches). Dimensions are not intended for manufacturing purposes.

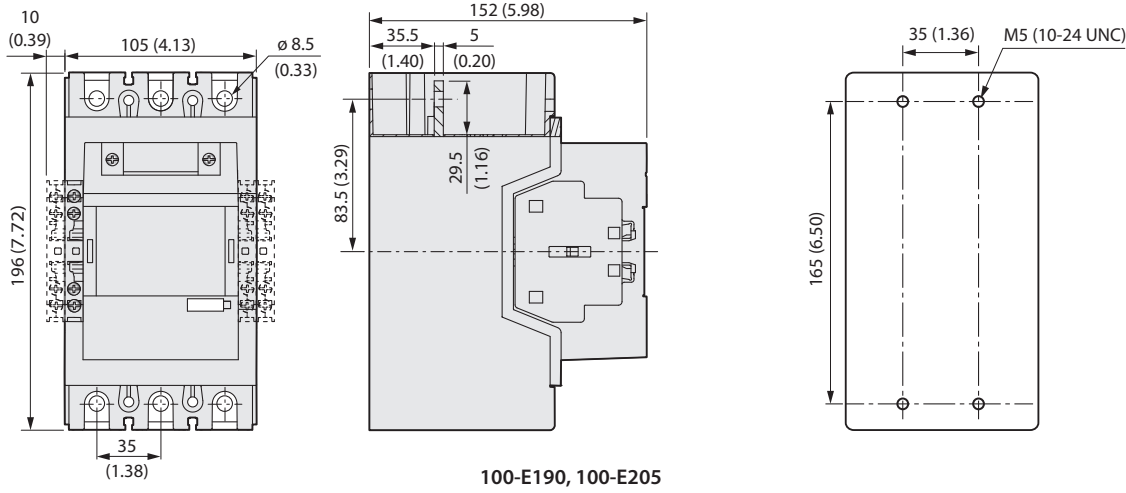
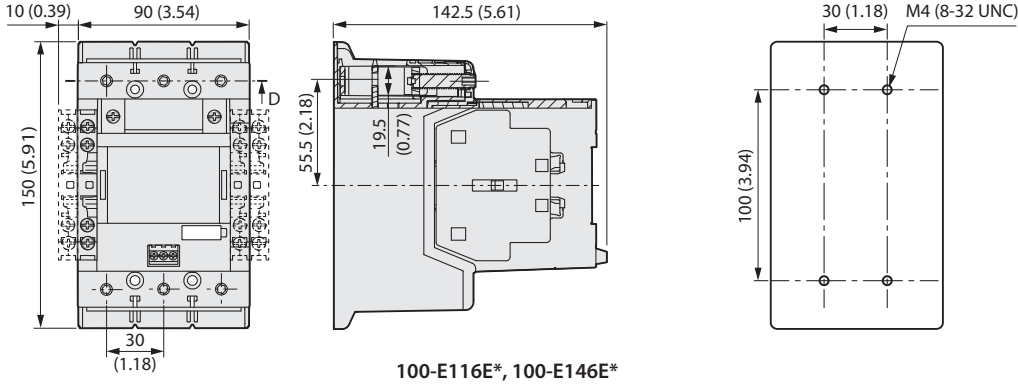
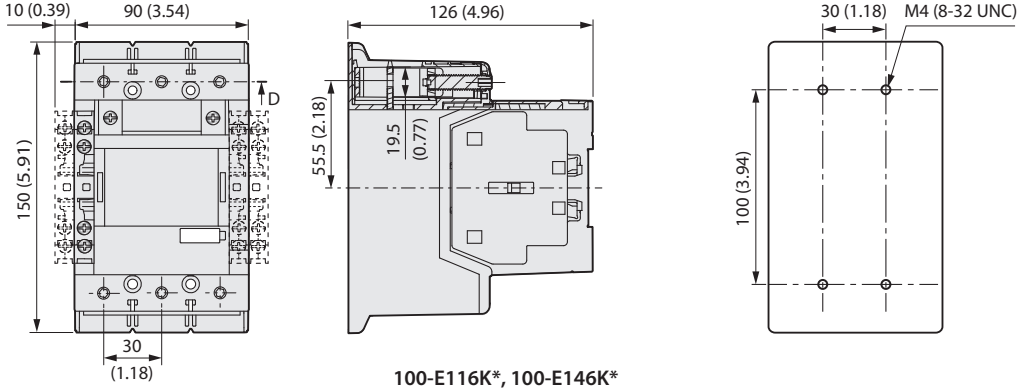

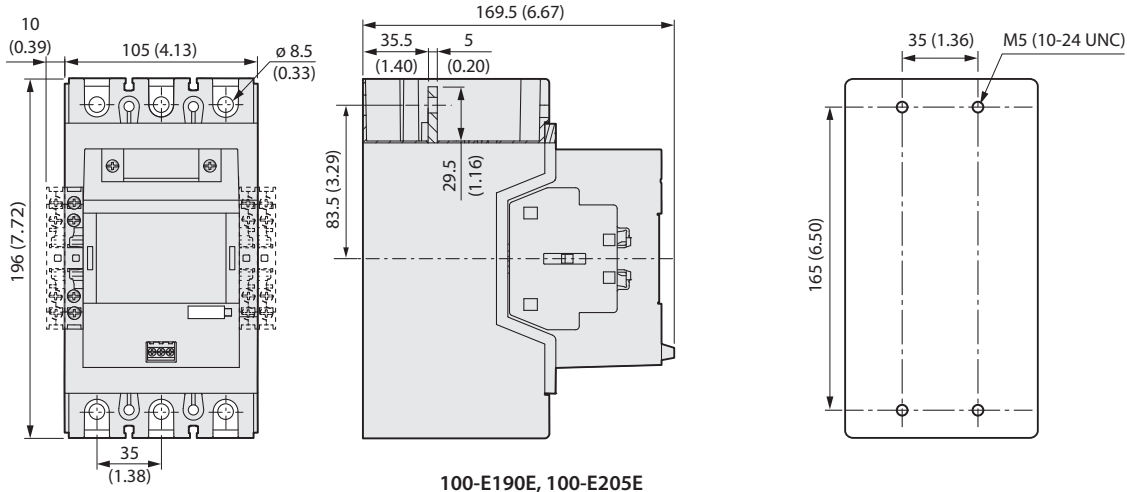

100-E190E, 100-E205E

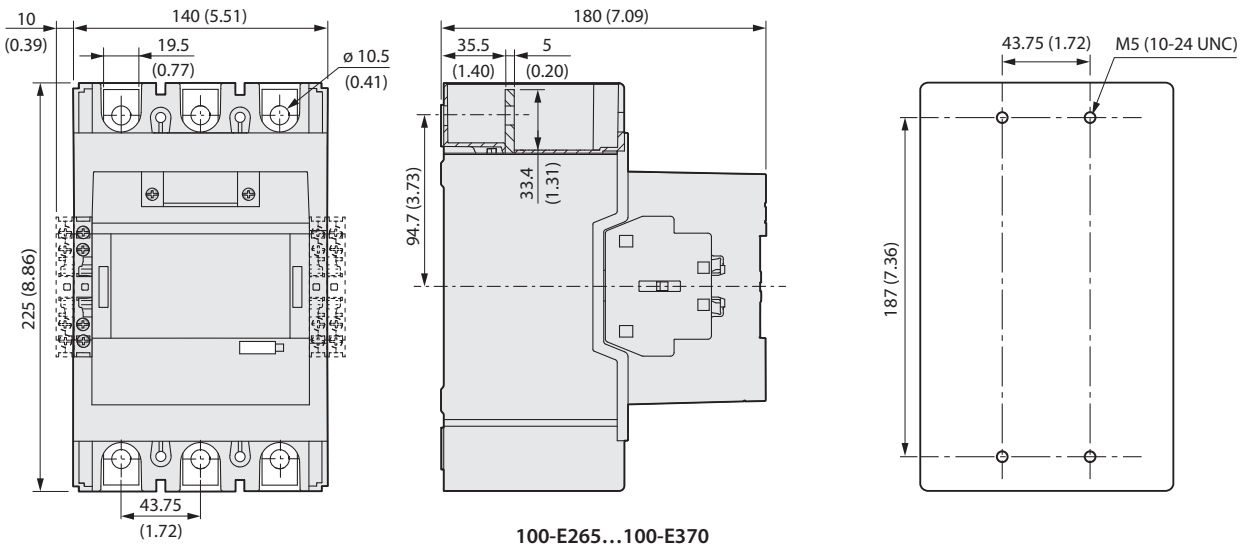

100-E265...100-E370

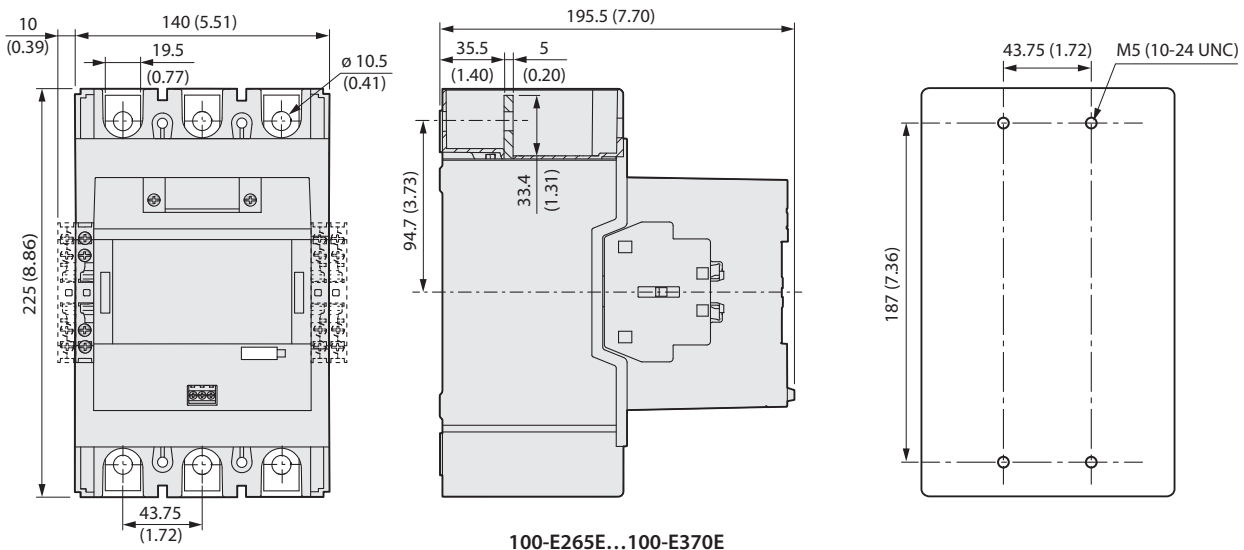

100-E265E...100-E370E

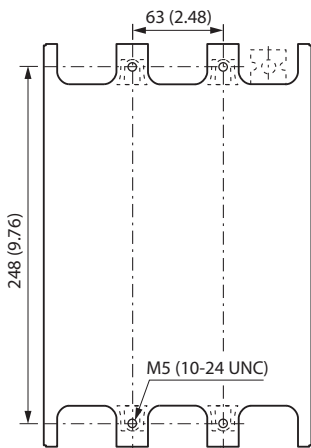
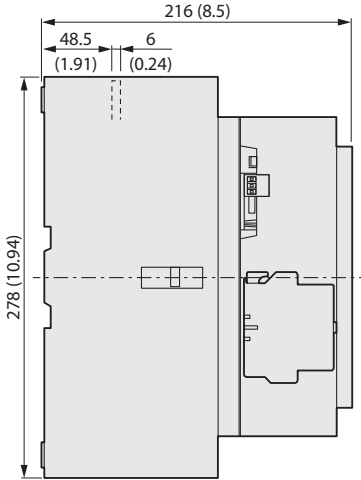
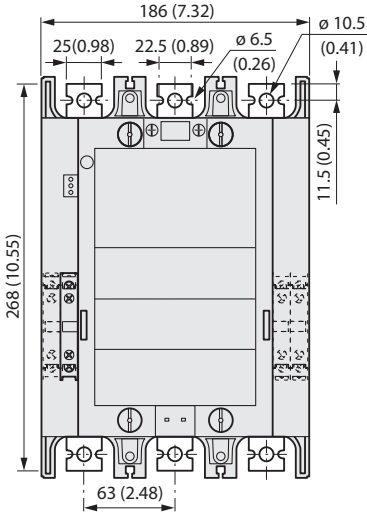

100-E400, 100-E460

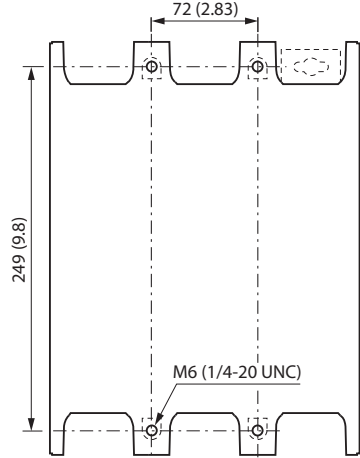
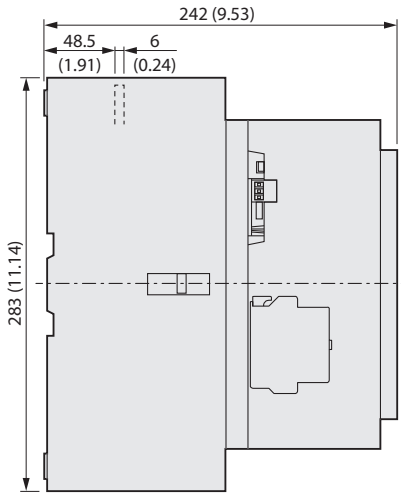
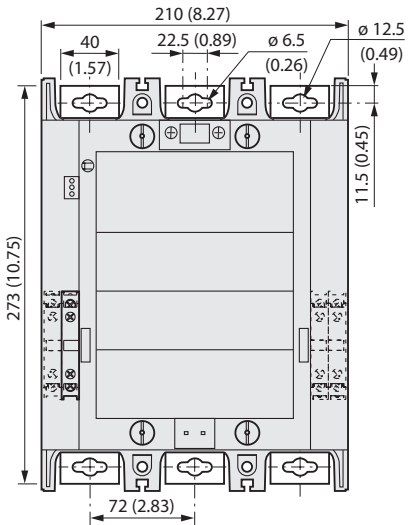

100-E580...100-E750

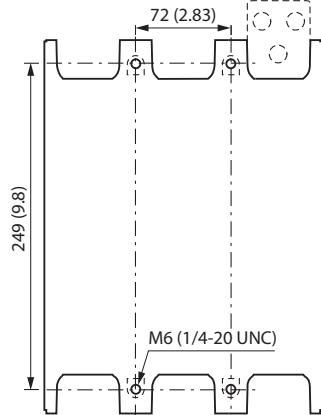
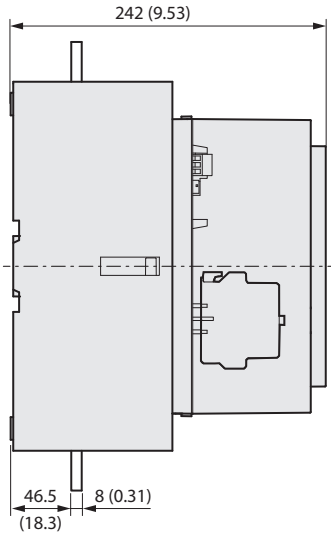
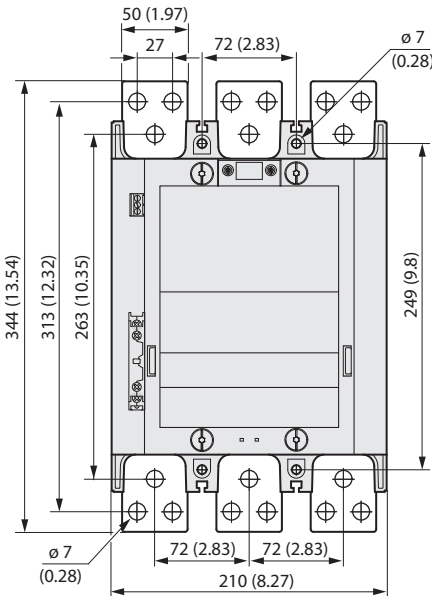

100-E1260

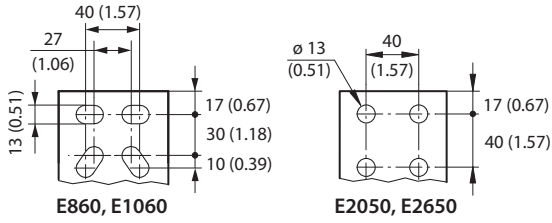

	E860, E1060, E2050	E2650
A	392 (15.43)	422 (16.61)
B	47 (1.85)	53 (2.09)
C	10 (0.39)	25 (0.98)

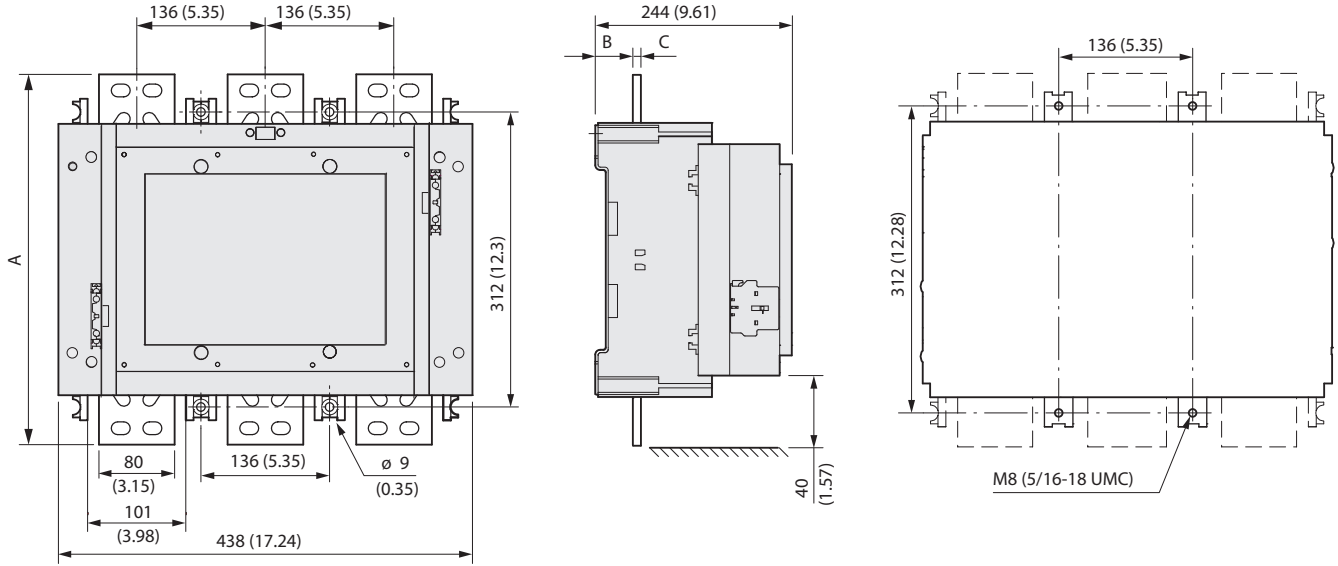

100-E860, 100-E1060, 100-E2050, 100-E2650

## Mounting Position

Figure 26 - 100-E116...100-E2650 — AC/DC and AC/DC with PLC input

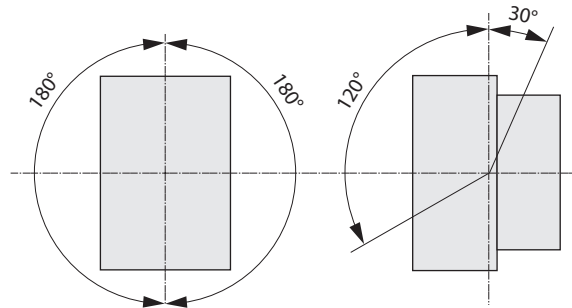

# 100-D/104-D, 100S-D Contactors

---

## Product Selection—100-D/104-D Contactors

- 63...500 kW @ 400V
- 75...600 Hp @ 460V
- 100...700 Hp @ 575V
- Electronic and conventional coils AC & DC
  - Integrated PLC interface
  - Low power pick-up & hold-in
  - Wide voltage ranges
- Complete range of accessories
- Environmentally friendly
- Compact dimensions



100-D Contactor



The Bulletin 100-D/104-D contactor family, along with a wide range of common accessories and Bulletin 193 electronic overload relays, provides the most compact and flexible starter component system available.

Bulletin 100S-D safety contactors were designed to address the needs of modern safety applications requiring feedback and monitoring of the energy isolating switchgear used in hazardous motion loads.

The 100S-D meets these needs through its "mirror contact" design. If a power contact welds, the N.C. auxiliary contacts will not change state. This feature provides reliable indication about the open/closed status of the main power poles. In addition, the gold-plated bifurcated auxiliary contacts are ideally suited for low-energy applications or feedback control circuits with multiple series-connected N.C. auxiliary contacts.



### 100-D/104-D 3-Pole AC- Operated Contactors

- Conventional and Electronic AC Coils
- 3 Main Contacts
- Non-Reversing or Reversing

Rated Operational Current $I_e$ [A]		Ratings for switching AC motors - AC-2, AC-3										Auxiliary Contacts		Non-Reversing Contactor	Reversing Contactor		
60 °C	40 °C	kW (50 Hz)							Hp (60 Hz)								
AC-3 (400V)	AC-1 (690V)	230V	400V	415V	500V	690V	1000V	200V	230V	460V	575V	N.O.	N.C.	Cat No.	Cat No.		
115	250	37	63	66	80	110	63	40	40	75	100	0	0	100-D115⊗00	—		
												1	1	100-D115⊗11	—		
												2	4	—	104-D115⊗24		
140	250	45	78	82	80	111	75	40	50	100	125	1	1	100-D140⊗00	—		
														100-D140⊗00	—		
														—	104-D140⊗24		
180	250	55	90	90	110	90	132	110	50	60	125	0	0	100-D180⊗00	—		
														1	1	100-D180⊗11	—
														2	4	—	104-D180⊗24
210	350	63	118	125	205	200	110	60	75	150	200	0	0	100-D210⊗00	—		
														1	1	100-D210⊗11	—
														2	4	—	104-D210⊗24
250	350	80	140	150	250	250	132	75	100	200	250	0	0	100-D250⊗00	—		
														1	1	100-D250⊗11	—
														2	4	—	104-D250⊗24
300	450	90	170	160	290	300	160	100	125	250	300	0	0	100-D300⊗00	—		
														1	1	100-D300⊗11	—
														2	4	—	104-D300⊗24
420	540	132	238	250	420	425	220	150	175	350	400	0	0	100-D420⊗00	—		
														1	1	100-D420⊗11	—
														2	4	—	104-D420⊗24
630	800	200	355	355	500	500	—	200	250	500	600	0	0	100-D630⊗00	—		
														1	1	100-D630⊗11	—
														2	4	—	104-D630⊗24
860	1000	250	500	500	500	600	—	250	300	600	700	0	0	100-D860⊗00	—		
														1	1	100-D860⊗11	—
														2	4	—	104-D860⊗24

### 3-Pole DC-operated Contactors

- Conventional and Electronic DC Coils
- 3 Main Contacts
- Non-Reversing or Reversing

Rated Operational Current $I_e$ [A]		Ratings for switching AC motors - AC-2, AC-3										Auxiliary Contacts		Non-Reversing Contactor	Reversing Contactor
60 °C	40 °C	kW (50 Hz)							Hp (60 Hz)						
AC-3 (400V)	AC-1 (690V)	230V	400V	415V	500V	690V	1000V	200V	230V	460V	575V	N.O.	N.C.	Cat No.	Cat No.
115	250	37	63	66	80	110	63	40	40	75	100	0	0	100-D115⊗00	—
												1	1	100-D115⊗11	—
												2	1/1L	100-D115⊗22L	—
												2	4	—	104-D115⊗24
												2	2/2L	—	104-D115⊗22L
140	250	45	78	82	80	111	75	40	50	100	125	0	0	100-D140⊗00	—
												1	1	100-D140⊗00	—
												2	1/1L	100-D140⊗22L	—
												2	4	—	104-D140⊗24
												2	2/2L	—	104-D140⊗22L
180	250	55	90	90	110	90	132	110	50	60	125	0	0	100-D180⊗00	—
												1	1	100-D180⊗00	—
												2	1/1L	100-D180⊗22L	—
												2	4	—	104-D180⊗24
												2	2/2L	—	104-D180⊗22L
210	350	63	118	125	205	200	110	60	75	150	200	0	0	100-D210⊗00	—
												1	1	100-D210⊗11	—
												2	4	—	104-D210⊗24
250	350	80	140	150	250	250	132	75	100	200	250	0	0	100-D250⊗00	—
												1	1	100-D250⊗11	—
												2	4	—	104-D250⊗24
300	450	90	170	160	290	300	160	100	125	250	300	0	0	100-D300⊗00	—
												1	1	100-D300⊗11	—
												2	4	—	104-D300⊗24
420	540	132	238	250	420	425	220	150	175	350	400	0	0	100-D420⊗00	—
												1	1	100-D420⊗11	—
												2	4	—	104-D420⊗24
630	800	200	355	355	500	500	—	200	250	500	600	0	0	100-D630⊗00	—
												1	1	100-D630⊗11	—
												2	4	—	104-D630⊗24
860	1000	250	500	500	500	600	—	250	300	600	700	0	0	100-D860⊗00	—
												1	1	100-D860⊗11	—
												2	4	—	104-D860⊗24

## Coil Voltage Codes—100-D/104-D Contactors

The Cat. No. as listed is incomplete. Select a coil voltage code from the table below to complete the Cat. No. Example: 120V, 60 Hz: Cat. No. 100-D115 $\otimes$ 11 becomes Cat. No.100-D115D11.

AC Voltages [V], Conventional Coil		24	48	100	110	120	200	208	220...230	230	240	277	380...400
100-D115...100-D180	50 Hz	K	Y	—	D	—	—	—	A	—	T	—	N
	60 Hz	J	X	—	—	D	—	H	—	—	A	T	—
100-D115	50/60 Hz	—	—	KP	KN	—	KG	—	KL	KF	KA	KT	—

AC Voltages [V], Conventional Coil		415	440	480	500	550	600
100-D115...100-D180	50 Hz	B	G	—	M	C	—
	60 Hz	—	N	B	—	—	C
100-D115	50/60 Hz	—	—	—	—	—	—

AC Voltages [V], Electronic Coil w/ El. Interface <sup>(1)</sup>		24	42...64	100	110...130	200	208...277	200...220
100-D115...100-D300	50/60 Hz	E <sup>(2)</sup>	EY	—	ED	—	EA	—
100-D420	50/60 Hz	—	—	—	ED	—	EA	—
100-D630...100-D860	50/60 Hz	—	—	EP	ED	EG	—	EG

AC Voltages [V], Electronic Coil w/ El. Interface <sup>(1)</sup>		230...250	277	380...415	380...500	440...480	500
100-D115...100-D300	50/60 Hz	—	—	—	EN	—	—
100-D420	50/60 Hz	—	—	—	EN	—	—
100-D630...100-D860	50/60 Hz	EA	ET	EN	—	EB	EM

(1) Signal voltage of the Cat. No. 100-D... electronic interface: nominal  $U_g$ : 24V DC/ $I_g$ : 15 mA

Pickup voltage: 13.0V DC...30.2V DC

Dropout Voltage: -3.0V DC...+5.0V DC

(2) Not available with 100/104-D300.

DC Voltages [V], Conventional Coil		24	48	110	125	220
100-D115...100-D180 <sup>(1)</sup>		ZJ	ZY	ZD	ZS	ZA

(1) For conventional DC coils, the pickup winding must be interconnected with the N.C. late-breaking auxiliary contact(s).

DC Voltages [V], Electronic Coil w/ El Interface <sup>(1)</sup>		24	48...72	110...130	200...255
100-D115...100-D300		EZJ	EZY	EZD	EZA
100-D420		—	—	EZD	EZA
100-D630...100-D860		—	—	ED	EA

(1) Signal voltage of the Cat. No. 100-D... electronic interface: nominal  $U_g$ : 24V DC/ $I_g$ : 15 mA

Pickup voltage: 13.0V DC...30.2V DC, Dropout Voltage: -3.0V DC...+5.0V DC.





# Product Selection—100S-D Safety Contactors

- 63...500 kW @ 400V
- 75...600 Hp @ 460V
- 100...700 Hp @ 575V
- Electronic and conventional coils
  - AC & DC
  - Integrated PLC interface
  - Low power pick-up & hold-in
  - Wide voltage ranges
- Complete range of accessories
- Environmentally friendly
- Compact dimensions



Bulletin 100S-D safety contactors were designed to address the needs of modern safety applications requiring feedback and monitoring of the energy isolating switchgear used in hazardous motion loads. The 100S-D meets these needs through its "mirror contact" design. If a power contact welds, the N.C. auxiliary contacts will not change state. This feature provides reliable indication about the open/closed status of the main power poles. In addition, the gold-plated bifurcated auxiliary contacts are ideally suited for low-energy applications or feedback control circuits with multiple series-connected N.C. auxiliary contacts.

## 3-Pole AC-Operated Contactors

Rated Operational Current $I_e$ [A]		Ratings for switching AC motors - AC-2, AC-3											Auxiliary Contacts		Cat No. <sup>(4)</sup>
60 °C	40 °C	kW (50 Hz) <sup>(1)</sup>							Hp (60 Hz)						
AC-3 (400V)	AC-1 (690V)	230V	400V	415V	500V <sup>(2)</sup>	690V	1000V	200V	230V	460V	575V	N.O.	N.C. <sup>(3)</sup>		
115	250	37	63	66/75	80	111	63	40	40	75	100	2	2	100S-D115 $\otimes$ 22BC	
140	250	45	78	82/90	80/100	110/132	75	40	50	100	125	2	2	100S-D140 $\otimes$ 22BC	
180	250	55	101	100	90/125	132/160	90	50	60	150	150	2	2	100S-D180 $\otimes$ 22BC	
210	350	63	118	110	205	200	110	60	75	150	200	2	2	100S-D210 $\otimes$ 22BC	
250	350	80	140	150	250	250	133	75	100	200	250	2	2	100S-D250 $\otimes$ 22BC	
300	450	90	170	160	290	300	160	100	125	250	300	2	2	100S-D300 $\otimes$ 22BC	
420	540	132	238	250	420	425	220	150	175	350	400	2	2	100S-D420 $\otimes$ 22BC	
630	800	200	355	355	500	500	—	200	250	500	600	2	2	100S-D630 $\otimes$ 22BC	
860	1000	250	500	500	500	600	—	250	300	600	700	2	2	100S-D860 $\otimes$ 22BC	



(1) Preferred values according to IEC 60072-1.

(2) Higher kW rating only applies to contactors with electronic coil.

(3) The N.C. contacts meet IEC 60947-4 Annex F requirements for mirror contact performance. The N.C. mirror contacts are wired in series or parallel and must be used as monitoring contacts with feedback to the safety circuit.

(4) If standard cross-stamped auxiliary contacts are required, remove the letter "B" before the letter "C" in the cat. no. Example: Cat. No. 100S-D115 $\otimes$ 22BC becomes Cat. No. 100S-D115 $\otimes$ 22C.

### 3-Pole DC-Operated Contactors

Rated Operational Current $I_e$ [A]		Ratings for switching AC motors - AC-2, AC-3										Auxiliary Contacts		Conventional Coil Cat. No.	Electronic Coil Cat No. <sup>(5)</sup>
60 °C	40 °C	kW (50 Hz) <sup>(1)</sup>							Hp (60 Hz)						
AC-3 (400V)	AC-1 (690V)	230V	400V	415V	500V	690V	1000V	200V	230V	460V	575V	N.O.	N.C. <sup>(3)</sup>		
115	250	37	63	66/75	80	111	63	40	40	75	100	2	2	100S-D115⊗33LC <sup>(4)</sup>	100S-D115⊗22BC
140	250	45	78	75	80/100 <sup>(2)</sup>	110/132	75	40	50	100	125	3	2/1L	100S-D140⊗33LC	100S-D140⊗22BC
180	250	55	101	100	90/125	132/160	90	50	60	150	150	3	2/1L	100S-D180⊗33LC	100S-D180⊗22BC
210	350	63	118	110	205	200	110	60	75	150	200	2	2	—	100S-D210⊗22BC
250	350	80	140	150	250	250	133	75	100	200	250	2	2	—	100S-D250⊗22BC
300	450	90	170	160	290	300	160	100	125	250	300	2	2	—	100S-D300⊗22BC
420	540	132	238	250	420	425	220	150	175	350	400	2	2	—	100S-D420⊗22BC
630	800	200	355	355	500	500	—	200	250	500	600	2	2	—	100S-D630⊗22BC
860	1000	250	500	500	500	600	—	250	300	600	700	2	2	—	100S-D860⊗22BC

- (1) Preferred values according to IEC 60072-1.
- (2) Higher kW rating only applies to contactors with electronic coil.
- (3) The N.C. contacts meet IEC 60947-4 Annex F requirements for mirror contact performance. The N.C. mirror contacts are wired in series or parallel and must be used as monitoring contacts with feedback to the safety circuit.
- (4) For conventional DC coil only. The pickup winding must be interconnected with the N.C. late-breaking auxiliary contacts.
- (5) If standard cross-stamped auxiliary contacts are required, remove the letter "B" before the letter "C" in the cat. no. Example: Cat. No. 100S-D115⊗22BC becomes Cat. No. 100S-D115⊗22C.

## Coil Voltage Codes—100S-D Safety Contactors

The Cat. No. as listed is incomplete. Select a coil voltage code from the table below to complete the Cat. No. Example: 120V, 60 Hz: Cat. No. 100S-D115⊗22BC becomes Cat. No.100S-D115D22BC.

AC Voltages [V], Conventional Coil		24	48	100	110	120	200	208	220...230	230	240	277
100S-D115...100S-D180	50 Hz	K	Y	—	D	—	—	—	A	—	T	—
	60 Hz	J	X	—	—	D	—	H	—	—	A	T
100S-D115	50/60 Hz	—	—	KP	KN	—	KG	—	KL	KF	KA	KT

AC Voltages [V], Conventional Coil		380...400	415	440	480	500	550	600
100S-D115...100S-D180	50 Hz	N	B	G	—	M	C	—
	60 Hz	—	—	N	B	—	—	C
100S-D115	50/60 Hz	—	—	—	—	—	—	—

AC Voltages [V], Electronic Coil w/ EI Interface <sup>(1)</sup>		24	42...64	100	110...130	200	208...277	200...220
100S-D115...100S-D300	50/60 Hz	EJ <sup>(2)</sup>	EY	—	ED	—	EA	—
100S-D420	50/60 Hz	—	—	—	ED	—	EA	—
100S-D630...100S-D860	50/60 Hz	—	—	EP	ED	EG	—	EG

AC Voltages [V], Electronic Coil w/ EI Interface <sup>(1)</sup>		230...250	277	380...415	380...500	440...480	500
100S-D115...100S-D300	50/60 Hz	—	—	—	EN	—	—
100S-D420	50/60 Hz	—	—	—	EN	—	—
100S-D630...100S-D860	50/60 Hz	EA	ET	EN	—	EB	EM

(1) Signal voltage of the Cat. No. 100S-D... electronic interface: nominal  $U_e$ : 24V DC/ $I_e$ : 15 mA

Pickup voltage: 13.0V DC...30.2V DC

Dropout Voltage: -3.0V DC...+5.0V DC

(2) Not available with 100S-D300

DC Voltages [V], Conventional Coil		24	48	110	125	220	250
100S-D115...100S-D180		ZJ	ZY	ZD	ZS	ZA	ZT



DC Voltages [V], Electronic Coil w/ EI Interface <sup>(1)</sup>		24	48...72	110...130	200...255
100S-D115...100S-D300		EZJ	EZY	EZD	EZA
100S-D420		—	—	EZD	EZA
100S-D630...100S-D860		—	—	ED	EA

(1) Signal voltage of the Cat. No. 100S-D... electronic interface: nominal  $U_e$ : 24V DC/ $I_e$ : 15 mA

Pickup voltage: 13.0V DC...30.2V DC, Dropout Voltage: -3.0V DC...+5.0V DC.

# Accessories

## Auxiliary Contacts

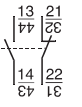
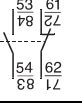
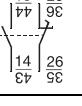
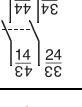
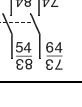
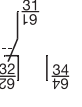
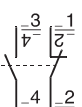
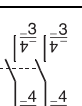
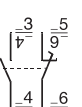
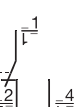
	Description			Connection Diagram	For Use With	Standard Auxiliary Contact Cat. No.	Bifurcated Cat. No.
		N.O.	N.C.				
	Auxiliary Contacts <ul style="list-style-type: none"> <li>• Side-mounted</li> <li>• Without IEC sequence terminal designations</li> <li>• Standard contacts 17V/10 mA Bifurcated contacts for signals down to 5V/2 mA</li> </ul>	1	1		100-D left or right inside mounting	100-DS1-11	100-DS1-B11H
		1	1		100-D left or right outside mounting	100-DS2-11	100-DS2-B11H
		1	1L		100-D left or right inside mounting	100-DS1-L11	—
		2	0		100-D left or right inside mounting	100-DS1-20	100-DS1-B20H
		2	0		100-D left or right outside mounting	100-DS2-20	100-DS2-B20H
	Auxiliary Contacts <ul style="list-style-type: none"> <li>• Electronic-compatible auxiliary contacts</li> <li>• Ideal for use when switching low- power control circuits</li> <li>• With IEC sequence terminal designations</li> <li>• Contact ratings: AC-12, 250V, 0.1 A</li> <li>• AC-15, DC-13, 3...125V, 1...100 mA</li> </ul>	1	1		100-D left or right inside mounting	100-DS1-B11	—
Auxiliary Contacts <ul style="list-style-type: none"> <li>• Side-mounted</li> <li>• Without IEC sequence terminal designations</li> <li>• Standard contacts 17V/10 mA Bifurcated contacts for signals down to 5V/2 mA</li> </ul>	1	1		100-D left or right inside mounting	100-DS0-11	100-DS0-B11H	
	2	0		100-D left or right inside mounting	100-DS0-20	100-DS0-B20H	
	1	1L		100-D left or right inside mounting	100-DS0-L11	—	
	Auxiliary Contacts <ul style="list-style-type: none"> <li>• Electronic-compatible auxiliary contacts</li> <li>• Ideal for use when switching low- power control circuits</li> <li>• Without IEC sequence terminal designations</li> <li>• Contact ratings: AC-12, 250V, 0.1 A</li> <li>• AC-15, DC-13, 3...125V, 1...100 mA</li> </ul>	1	1		100-D left or right inside mounting	100-DS0-B11	—

Auxiliary contacts with sequence numbering.

Figure 27 - Cat. Nos. 100-D115... D420 — Electronic and Conventional AC Coils, Electronic DC Coils

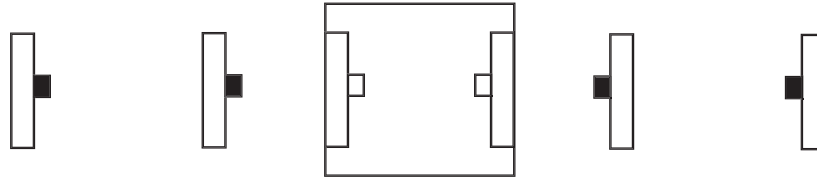

Contact Configuration		Auxiliary Contact Configurations				
		For Use With	Left Side Mounting		Right Side Mounting	
N.O.	N.C.		Outside Cat. No.	Inside Cat. No.	Inside Cat. No.	Outside Cat. No.
8	0	100-D...00	100-DS2-20	100-DS1-20	100-DS1-20	100-DS2-20
Sequence Starts with:			7/8	3/4	1/2	5/6
7	1		100-DS2-20	100-DS1-20	100-DS1-11	100-DS2-20
Sequence Starts with:			7/8	3/4	1/2	5/6
6	2		100-DS2-20	100-DS1-11	100-DS1-11	100-DS2-20
Sequence Starts with:			7/8	3/4	1/2	5/6
5	3		100-DS2-20	100-DS1-11	100-DS1-11	100-DS2-11
Sequence Starts with:			7/8	3/4	1/2	5/6
4	4	100-DS2-11	100-DS1-11	100-DS1-11	100-DS2-11	
Sequence Starts with:		7/8	3/4	1/2	5/6	

Figure 28 - Cat. Nos. 100-D115... D420 — Electronic and Conventional AC Coils, Electronic DC Coils

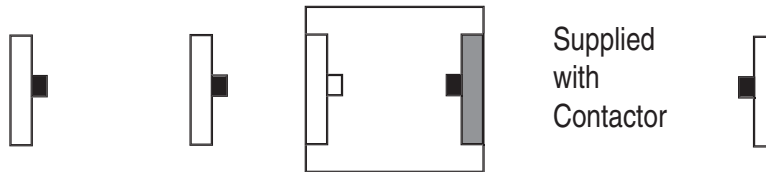

Contact Configuration		Auxiliary Contact Configurations				
		For Use With	Left Side Mounting		Right Side Mounting	
N.O.	N.C.		Outside Cat. No.	Inside Cat. No.	Inside Cat. No.	Outside Cat. No.
8	0	100-D...11	—	—	—	—
Sequence Starts with:			—	—	—	—
7	1		100-DS2-20	100-DS1-20	100-DS1-11	100-DS2-20
Sequence Starts with:			7/8	3/4	1/2	5/6
6	2		100-DS2-20	100-DS1-11	100-DS1-11	100-DS2-20
Sequence Starts with:			7/8	3/4	1/2	5/6
5	3		100-DS2-20	100-DS1-11	100-DS1-11	100-DS2-11
Sequence Starts with:			7/8	3/4	1/2	5/6
4	4	100-DS2-11	100-DS1-11	100-DS1-11	100-DS2-11	
Sequence Starts with:		7/8	3/4	1/2	5/6	

Figure 29 - Cat. Nos. 100-D115... D180 — Conventional DC Coils

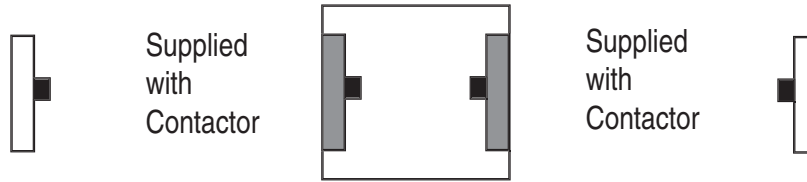

Contact Configuration		Auxiliary Contact Configurations				
		For Use With	Left Side Mounting		Right Side Mounting	
N.O.	N.C.		Outside Cat. No.	Inside Cat. No.	Inside Cat. No.	Outside Cat. No.
8	0	100-D...22L	—	—	—	—
Sequence Starts with:			—	—	—	—
7	1		—	—	—	—
Sequence Starts with:			—	—	—	—
6	2		100-DS2-20	100-DS1-11	100-DS1-11 <sup>(1)</sup>	100-DS2-20
Sequence Starts with:			7/8	3/4	1/2	5/6
5	3		100-DS2-20	100-DS1-11	100-DS1-11 <sup>(1)</sup>	100-DS2-11
Sequence Starts with:			7/8	3/4	1/2	5/6
4	4	100-DS2-11	100-DS1-11	100-DS1-11 <sup>(1)</sup>	100-DS2-11	
Sequence Starts with:		7/8	3/4	1/2	5/6	

(1) With conventional DC control, the pickup winding must be interconnected with the N.C. late-breaking auxiliary contacts.

Marking Systems (For 100-D115...D860 contactors)

	Description	Pkg. Qty. <sup>(1)</sup>	Cat. No.
	Label Sheet • 105 self-adhesive paper labels each, 6 x 17 mm	10	100-FMS
	Marking Tag Sheet • 160 perforated paper labels each, 6 x 17 mm, to be used with a transparent cover	10	100-FMP
	Transparent Cover • To be used with marking tag sheets	100	100-FMC
	Marking Tag Adapters • To be used with marking tag: System V4/V5	100	100-FMA1
	Marking Tag Adapters • To be used with marking tag: System 1492 W	100	100-FMA2



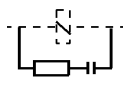
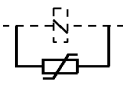

(1) Must be ordered in multiples of package quantities.

Suppressor Modules

	Description	Connection Diagram	Suppressor Rating	For Use With	Cat. No. <sup>(3)</sup>	
 <p>Suppressor Module for Bul. 100-D Contactors</p> <ul style="list-style-type: none"> <li>For limiting surge voltage when coil circuits are interrupted</li> <li>Supplied as standard on all conventional DC coil contactors and all electronic coil contactors (as part of the supply module or delivered with separate suppressor module)</li> </ul>			RC Module (AC control) For contactors with conventional coil 21...48V, 50 Hz; 24...55V, 60 Hz	100- D115...100- D180	100-DFSC48	
			95...110V, 50 Hz; 110...127V, 60 Hz		100-DFSC110	
			180...277V, 50 Hz; 208...277V, 60 Hz		100-DFSC240	
			380...550V, 50 Hz; 440...600V, 60 Hz		100-DFSC550	
			Varistor Module for contactors with conventional coil 55V AC	100- D115...100- D420	56...136V AC	100-DFS55
					137...277V AC	100-DFS136
					278...600V AC	100-DFS277
					Varistor Module for contactors with electronic coil 200...277V AC <sup>(1)</sup>	100-DFS550
					380...500V AC <sup>(2)</sup>	100-DFS500





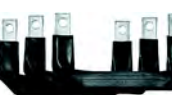

- (1) For overvoltage category IV (IEC 947 for 100-D...-E) e.g., lightning protection requirements.
- (2) For surge pulse > 1kV
- (3) Package Quantity = 1

Connecting Components

	Description	Cross-section	For Use With			Terminal Connection	Cat. No. <sup>(1)</sup>
			100-D115... 180	100-D210... 420	100-D630... 860		
	Reversing: Input Connection Wye-Delta: Main-Delta connection	50 mm <sup>2</sup>	X	—	—	Terminal Blocks, 100-DTB... Lugs, 100-DL...	100-D180-VLTB
		120 mm <sup>2</sup>	—	X	—		100-D420-VLTB
		350 mm <sup>2</sup>	—	—	X		100-D860-VL
	Reversing: Output Connection Wye-Delta: Delta-Wye connection	50 mm <sup>2</sup>	X	—	—	Lugs, 100-DL...	100-D180-VT
		120 mm <sup>2</sup>	—	X	—		100-D420-VT
		350 mm <sup>2</sup>	—	—	X		100-D860-VT
		50 mm <sup>2</sup>	X	—	—	Terminal Blocks, 100-DTB...	100-D180-VTTB
	Delta-Wye connection if 100-D115...180 is used as a Wye contactor	80 mm <sup>2</sup>	—	X	—	Terminal Blocks, 100-DTB...	100-D420-VYTB
	Wye-Delta: Neutral bridge	—	X	—	—	—	100-D180-VYU
		—	—	X	—	—	100-D420-VYU
		—	—	—	X	—	100-D860-VYU
	Power Wiring Kits (for contactors using 100-DL lug kits)	For 100-D115...D100-D180	Reversing			100-DPW180	
			Two-speed, or changeover			100-D180-VLTB	
			Wye-Delta/Star-Delta			100-DPY180	
		For 100-D210...100-D420	Reversing			100-DPW420	
			Two-speed, or changeover			100-D420-VLTB	
			Wye-Delta/Star-Delta			100-DPY420	
For 100-D630...100-D860	Reversing			100-DPW860			
	Two-speed, or changeover			100-D860-VL			

(1) Package Quantity = 1

Connecting Components, Continued

	Description	For Use With	Cat. No. <sup>(1)</sup>	
	Terminal Lugs • Set of two • Protection class IP2X per IEC 60529 and DIN 40 050	100-D115, 100-D140, 100-D180, 100-D115E...D180E, 193-EC_F, 193-EE_F	100-DTB180	
		100-D210...100-D420, 193-EC_G, 193-EF2C, 193-EE_G	100-DTB420	
	Terminal Lugs (UL/CSA), Copper Frame Set of three	100-D115, 100-D140, 100-D180, 193-EC_F, 193-EE_F	100-DL180	
		100-D210...100-D420, 193-EC_G, 193-EE_G	100-DL420	
		100-D630, 100-D860, 193-EC_H, 193-EE_H	100-DL630	
		100-D630, 100-D860, 193-EC_H, 193-EE_H	100-DL860	
	Control Circuit Terminal 2 x 25 mm <sup>2</sup>	Connects to Cat. Nos. 100-D115...D180	100-DAT1	
		Connects to Cat. Nos. 100-D210...D420	100-DAT2	
	Terminal Shields • Set of two • Protection class IP10 per IEC 60529 and DIN 40 050 • For direct-on-line, reversing, two-speed, and wye-delta/star-delta assemblies	100-D115, 100-D140, 100-D180, 100-D115E...100-D180-E	100-DTS180	
		100-D210...100-D420	100-DTS420	
	Terminal Covers • Protection class IP10 per IEC 60529 and DIN 40 050 • For direct-on-line, reversing, two-speed, and wye-delta/star-delta assemblies	100-D115...100-D180, 193-EC_F, 193-EE_F	100-DTC180	
		100-D120...100-D420, 193-EC_G, 193-EE_G	100-DTC420	
		100-D630...100-D860, 193-EC_H, 193-EE_H	100-DTC860	
	Terminal Covers • Line-side panel relay and reversing cover	100-D630...100-D860, 193-EC_H, 193-EE_H	100-DTCE860	
	Terminal Covers • Reversing starter/ relay cover		100-DTCR860	
Terminal Covers • DOL Starter/relay cover		100-SDTCS860		
	Mounting Plate • Galvanized steel plate for starter combinations • For direct-on-line, reversing, two-speed, and wye-delta/star-delta, and Dahlander assemblies	100-D115...100-D180	Direct-on-line	100-DMS180
			Reversing, two-speed or changeover	100-DMU180
			Y- or Dahlander	100-DMY180
		100-D120...100-D420, 193-EC_G, 193-EE_G	Direct-on-line	100-DMS420
			Reversing, two-speed or changeover	100-DMU420
			Y- or Dahlander	100-DMY420
		100-D630...100-D860, 193-EC_H, 193-EE_H	Direct-on-line	100-DMS860
			Reversing, two-speed or changeover	100-DMU860
			Y- or Dahlander	100-DMY860
	Mounting Plate • For two-speed or changeover switched		For interlocking between 100-C60...C97 and 100-D115...D180 contactors	100-DMU85

(1) Package Quantity = 2





**Interlocks**

	Description	Circuit Diagram	For Use With	Cat. No. <sup>(1)</sup>
	Interlock — Dual Electrical/Mechanical <ul style="list-style-type: none"> <li>No additional space requires</li> <li>Two N.C. auxiliary contacts</li> </ul>	<pre> 22  NC  21    ▲      ---▽---    ▲ 21  NC  22                     </pre>	100-D115...100-D860	100-DMD02
	Interlock — Mechanical Only <ul style="list-style-type: none"> <li>No additional space required</li> </ul>	<pre> ---▽---                     </pre>	100-D115...100-D860	100-DMD00
	Interlock — Mechanical Only <ul style="list-style-type: none"> <li>Provides interlocking between Bul. 100-C and Bul. 100-D contactors</li> </ul>	<pre> ---▽---                     </pre>	100-C60...100-C97 between 100-D115...100-D180	100-DMC00
	Interlock — Dual Electrical/Mechanical <ul style="list-style-type: none"> <li>Provides interlocking between Bul. 100-C and Bul. 100-D contactors</li> <li>Two N.C. auxiliary contacts</li> </ul>	<pre> 22  NC  21    ▲      ---▽---    ▲ 21  NC  22                     </pre>	100-C60...100-C97 between 100-D115...100-D180	100-DMC02

(1) Package Quantity = 1

**Renewal Parts**

	Description	Coil Type	For Use With	Cat. No.		
	Arc Chambers for Contactors <ul style="list-style-type: none"> <li>For 3-pole 100-D Contactors</li> </ul>	Conventional	100-D115	100-DA-115		
			100-D180	100-DA-180		
		Electronic	100-D115	100-DAE-115		
			100-D140	100-DAE-140		
			100-D180	100-DAE-180		
			100-D210	100-DAE-210		
			100-D250	100-DAE-250		
			100-D300	100-DAE-300		
	Main Contacts for Contactors <ul style="list-style-type: none"> <li>3 complete sets for 3-pole 100-D Contactors</li> </ul>	Conventional	100-D115	100-DC-115		
			100-D140	100-DC-140		
			100-D180	100-DC-180		
		Electronic	100-D115	100-DCE-115		
			100-D140	100-DCE-140		
			100-D180	100-DCE-180		
			100-D210	100-DCE-210		
			100-D250	100-DCE-250		
			100-D300	100-DCE-300		
			100-D420	100-DCE-420		
			100-D630	100-DCE-630		
			100-D860	100-DCE-860		
			Terminal Hardware <ul style="list-style-type: none"> <li>Set of 6</li> </ul>	Conventional	100-D115...D180	100-DHF180
					100-D115E...D180	100-DHF180
Electronic	100-D210...D420	100-DHF420				
	100-D630...D860	100-DHF860				

Replacement Coils



Conventional AC Coils							Conventional DC Coils				
AC Standard Control Voltages [V]			AC Coil Code	100-D95...D180	100-D210...D420	100-D630...D860	DC Standard Control Voltages [V]	DC Coil Code	100-D95...D180	100-D210...D420	100-D630...D860
50 Hz	60 Hz	50/60 Hz		Cat. No.	Cat. No.	Cat. No.			Cat. No.	Cat. No.	Cat. No.
24V	—	—	K	TG407	—	—	24V	ZJ	TG714	—	—
—	24V	—	J	TG013	—	—	48V	ZY	TG724	—	—
48V	—	—	Y	TG414	—	—	110V	ZD	TG733	—	—
42V	48V	—	X	TG482	—	—	125V	ZS	TG737	—	—
—	—	100V <sup>(1)</sup>	KP	TG861	—	—	220V	ZA	TG761	—	—
110V	120V	—	D	TG473	—	—					
—	—	110V <sup>(1)</sup>	KN	TG856	—	—					
—	208V	—	H	TG049	—	—					
—	—	200V <sup>(1)</sup>	KG	TG862	—	—					
—	—	220V <sup>(1)</sup>	KL	TG857	—	—					
220...230V	240V	—	A	TG441	—	—					
240V	277V	—	T	TG480	—	—					
—	—	277V <sup>(1)</sup>	KT	TG060	—	—					
—	—	230V <sup>(1)</sup>	KF	TG851	—	—					
—	—	240V <sup>(1)</sup>	KA	TG858	—	—					
380...400V	440V	—	N	TG071	—	—					
415V	480V	—	B	TG475	—	—					
440V	—	—	G	TG478	—	—					
500V	—	—	M	TG479	—	—					
550V	600V	—	C	TG476	—	—					
Electronic AC Coils							Electronic DC Coils				
AC Standard Control Voltages [V]			AC Coil Code	100-D95...D180	100-D210...D420	100-D630...D860	DC Standard Control Voltages [V]	DC Coil Code	100-D95...D180	100-D210...D420	100-D630...D860
50 Hz	60 Hz	50/60 Hz		Cat. No.	Cat. No.	Cat. No.			Cat. No.	Cat. No.	Cat. No.
—	—	24V	EJ <sup>(2)</sup>	TGE855	—	—	24V	EZJ	TGE708	—	—
—	—	42...64V	EY	TGE864	—	—	48...72V	EZY	TGE779	—	—
—	—	100V	EP	TGE861	THE861	TJE861	110...130V	EZD	TGE780	THE780	—
—	—	110...130V	ED	TGE865	THE865	TJE865		ED	—	—	TJE865
—	—	200V	EG	TGE862	THE862	—	200...255V	EZA	TGE781	THE781	—
—	—	208...277V	EA	TGE866	THE866	—		EA	—	—	TJE879
—	—	200...220V	EG	—	—	TJE878					
—	—	230...250V	EA	—	—	TJE879					
—	—	380...500V	EN	TGE867	THE867	—					
—	—	380...415V	EN	—	—	TJE867					
—	—	440...480V	EB	—	—	TJE868					
—	—	500V	EM	—	—	TJE869					

(1) Applies to 100-D95...D115 contactors only. Not available with 100-D140...D180 contactors.  
 (2) Not available on 100/104?D300

# Specifications

			100/104-D,100S-D										
			115	140	140	180	180	210	250	300	420	630	860
Coil Type:	Conventional		X	X	—	X	—	—	—	—	—	—	—
	Electronic — EI		X	—	X	—	X	X	X	X	X	X	X
<b>AC-1 Active Power Load (50 Hz); Ambient temperature 40 °C</b>													
Rated Operational Current, $I_e$	≤500V	[A]	250	250	250	250	250	350	350	450	540	800	1000
	690V	[A]	250	250	250	250	250	350	350	450	540	800	1000
	1000V	[A]	250	250	250	250	250	350	350	450	540	—	—
	230V	[kW]	100	100	100	100	100	139	139	179	199	319	398
	240V	[kW]	104	104	104	104	104	145	145	187	208	333	416
	400V	[kW]	173	173	173	173	173	242	242	312	346	554	693
	415V	[kW]	180	180	180	180	180	252	252	323	359	575	719
	500V	[kW]	217	217	217	217	217	303	303	390	433	693	866
	690V	[kW]	299	299	299	299	299	418	418	538	598	956	1195
	1000V	[kW]	433	433	433	433	433	606	606	779	866	—	—
<b>AC-1 Active Power Load (50 Hz); Ambient temperature 60 °C</b>													
Rated Operational Current, $I_e$	≤500V	[A]	210	210	210	210	210	300	300	380	425	—	—
	690V	[A]	210	210	210	210	210	300	300	380	425	—	—
	1000V	[A]	210	210	210	210	210	300	300	380	425	—	—
	230V	[kW]	84	84	84	84	84	120	120	151	169	—	—
	240V	[kW]	87	87	87	87	87	125	125	158	177	—	—
	400V	[kW]	145	145	145	145	145	208	208	263	294	—	—
	415V	[kW]	151	151	151	151	151	216	216	273	305	—	—
	500V	[kW]	182	182	182	182	182	260	260	329	368	—	—
	690V	[kW]	251	251	251	251	251	359	359	454	508	—	—
	1000V	[kW]	364	364	364	364	364	520	520	658	736	—	—
<b>Switching of 3-phase Motors; (50 Hz) Ambient temperature 60 °C, AC-2, AC-3</b>													
Rated Operational Current, $I_e$	230V	[A]	115	140	140	180	180	210	250	300	420	630	860
	240V	[A]	115	140	140	180	180	210	250	300	420	630	860
	400V	[A]	115	140	140	180	180	210	250	300	420	630	860
	415V	[A]	115(130) <sup>(1)</sup>	140(155) <sup>(1)</sup>	140(155) <sup>(1)</sup>	180(189) <sup>(1)</sup>	180(189) <sup>(1)</sup>	210(227) <sup>(1)</sup>	250(258) <sup>(1)</sup>	300(315) <sup>(1)</sup>	420	630	860
	500V	[A]	115	115	140	140	180	210	250	300	420	630	753
	690V	[A]	115	115	140	140	180	210	250	300	420	492	—
	1000V	[A]	46	55	55	65	65	80	95	115	160	—	—
	230V	[kW]	37	45	45	57	57	67	80	97	135	200	250
	240V	[kW]	38	47	47	60	60	70	83	101	141	200	250
	400V	[kW]	64	78	78	101	101	118	140	170	238	355	500
	415V	[kW]	66(75) <sup>(1)</sup>	82(90) <sup>(1)</sup>	82(90) <sup>(1)</sup>	105(110) <sup>(1)</sup>	105(110) <sup>(1)</sup>	122(132) <sup>(1)</sup>	145(150) <sup>(1)</sup>	176(185) <sup>(1)</sup>	250	355	500
	500V	[kW]	80	80	98	98	126	147	177	213	298	450	560
	690V	[kW]	111	111	135	135	176	205	250	293	424	500	—
	1000V	[kW]	63	75	75	90	90	110	132	160	225	—	—

(1) 415 V: values in ( ) AC-2 and AC-3 lifespan -25 %

		100/104-D, 100S-D										
		115	140	140	180	180	210	250	300	420	630	860
Coil Type:	Conventional	X	X	—	X	—	—	—	—	—	—	—
	Electronic — EI	X	—	X	—	X	X	X	X	X	X	X

**Load Carrying Capacity per UL/CSA**

General Purpose Current (enclosed)		[A]	220	220	220	220	220	300	300	340	420	630	860
Rated power (enclosed) 1-phase	115V	[A]	100	135	135	—	—	—	—	—	—	—	—
	230V	[A]	110	136	136	176	176	216	—	—	—	—	—
	115V	[Hp]	10	15	15	—	—	—	—	—	—	—	—
	230V	[Hp]	25	30	30	40	40	50	—	—	—	—	—
Rated power (enclosed) 3-phase	200V	[A]	120	120	120	150	150	177	221	285	414	552	692
	230V	[A]	104	130	130	154	154	192	248	312	420	602	720
	460V	[A]	96	124	124	180	180	180	240	302	414	590	702
	575V	[A]	99	125	125	144	144	192	242	289	382	562	651
	200V	[Hp]	40	40	40	50	50	60	75	100	150	200	250
	230V	[Hp]	40	50	50	60	60	75	100	125	175	250	300
	460V	[Hp]	75	100	100	150	150	150	200	250	350	500	600
	575V	[Hp]	100	125	125	150	150	200	250	300	400	600	700

**Switching of 3-phase Motors, (50 Hz); Ambient temperature 60 °C, AC-4**

230V	[A]	115	140	140	180	180	210	250	300	420	—	—
240V	[A]	115	140	140	180	180	210	250	300	420	—	—
400V	[A]	115	140	140	180	180	210	250	300	420	—	—
415V	[A]	115(130) <sup>(2)</sup>	140(155) <sup>(2)</sup>	140(155) <sup>(2)</sup>	180(189) <sup>(3)</sup>	180(189) <sup>(3)</sup>	210(227)‡	250(258)‡	300(315)‡	420	—	—
500V	[A]	115	115	140	140	170	210	250	300	360	—	—
690V	[A]	115	115	140	140	170	210	250	300	360	—	—
1000V	[A]	46	55	55	65	65	80	95	115	160	—	—
230V	[kW]	37	45	45	57	57	67	80	97	135	—	—
240V	[kW]	39	47	47	60	60	70	83	101	141	—	—
400V	[kW]	63	78	78	100	100	118	140	170	238	—	—
415V	[kW]	66(75) <sup>(2)</sup>	82(90) <sup>(2)</sup>	82(90) <sup>(2)</sup>	105(110) <sup>(2)</sup>	105(110) <sup>(2)</sup>	125(132) <sup>(2)</sup>	145(150) <sup>(2)</sup>	176(185) <sup>(2)</sup>	250	—	—
500V	[kW]	80	80	98	98	119	147	177	213	255	—	—
690V	[kW]	110	110	135	135	167	205	250	293	356	—	—
1000V	[kW]	63	75	75	90	90	110	132	160	225	—	—

**AC-4 at approximately 200,000 operations**

230V	[A]	53	60	60	67	67	85	105	140	170	—	—
240V	[A]	53	60	60	67	67	85	105	140	170	—	—
400/415V	[A]	53	60	60	67	67	85	105	140	170	—	—
500V	[A]	53	60	60	67	67	85	105	140	170	—	—
690V	[A]	53	60	60	67	67	85	105	140	170	—	—
1000V	[A]	25	37	37	43	43	60	72	85	105	—	—
230V <sup>(1)</sup>	[kW]	15	17	17	20	20	25	32	45	55	—	—
240V <sup>(1)</sup>	[kW]	15	18.5	18.5	22	22	25	32	45	55	—	—
400V <sup>(1)</sup>	[kW]	25	32	32	37	37	45	55	75	90	—	—
415V <sup>(1)</sup>	[kW]	25	32	32	37	37	50	55	80	100	—	—
500V <sup>(1)</sup>	[kW]	32	40	40	45	45	55	75	100	110	—	—
690V <sup>(1)</sup>	[kW]	45	55	55	63	63	80	100	132	160	—	—
1000V <sup>(1)</sup>	[kW]	30	50	50	55	55	80	100	110	150	—	—
Max. switching frequency	Ops/hour	120	120	120	100	100	120	100	70	70	—	—

(1) Power ratings at 50 Hz; Preferred values according to IEC 60072-1

(2) 415V: Values in ( ) AC-3 and AC-4 lifespan -25%

(3) Approval pending on Cat. No. 100-D210...D860.

			100/104-D,100S-D										
			115	140	140	180	180	210	250	300	420	630	860
Coil Type:	Conventional		X	X	—	X	—	—	—	—	—	—	—
	Electronic — EI		X	—	X	—	X	X	X	X	X	X	X
Wye-Delta (60 Hz)													
	200V	[Hp]	60	60	60	75	75	100	125	175	250	—	—
	230V	[Hp]	60	75	75	100	100	125	175	200	250	—	—
	460V	[Hp]	125	175	175	200	200	250	350	450	600	—	—
	575V	[Hp]	150	200	200	250	250	300	450	500	650	—	—
UL/CSA Elevator Duty													
	200V	[A]	78	92	92	120	120	150	150	177	221	—	—
	230V	[A]	80	104	104	130	130	130	154	192	248	—	—
	460V	[A]	77	96	96	124	124	156	180	180	240	—	—
	575V	[A]	77	77	77	99	99	125	144	192	242	—	—
	200V	[Hp]	25	30	30	40	40	50	50	60	75	—	—
	230V	[Hp]	30	40	40	50	50	50	60	75	100	—	—
	460V	[Hp]	60	75	75	100	100	125	150	150	200	—	—
	575V	[Hp]	75	75	75	100	100	125	150	200	250	—	—
Star-Delta Starting (50 Hz)													
	≤ 230V	[A]	199	242	242	312	312	364	433	520	727	—	—
	≤ 240V	[A]	199	242	242	312	312	364	433	520	727	—	—
	400V	[A]	199	242	242	312	312	364	433	520	727	—	—
	415V	[A]	199 (225) <sup>(2)</sup>	242(268) <sup>(2)</sup>	242 (268) <sup>(2)</sup>	312 (332) <sup>(2)</sup>	312 (332) <sup>(2)</sup>	364 (393) <sup>(2)</sup>	433 (447) <sup>(2)</sup>	520 (546) <sup>(2)</sup>	727	—	—
	500V	[A]	199	199	242	312	312	364	433	520	727	—	—
	690V	[A]	199	199	242	312	312	364	433	520	727	—	—
	1000V	[A]	80	95	95	113	113	139	165	200	277	—	—
	230V <sup>(1)</sup>	[kW]	63	75	75	90	90	110	132	160	220	—	—
	240V <sup>(1)</sup>	[kW]	66	80	80	100	100	125	150	160	250	—	—
	400V <sup>(1)</sup>	[kW]	110	132	132	160	160	200	250	300	425	—	—
	415V <sup>(1)</sup>	[kW]	114 (132) <sup>(2)</sup>	132 (160) <sup>(2)</sup>	132 (160) <sup>(2)</sup>	160	160	220	250	315 (335) <sup>(2)</sup>	425	—	—
	500V <sup>(1)</sup>	[kW]	132	132	160	200	200	250	315	375	530	—	—
	690V <sup>(1)</sup>	[kW]	192	200	220	300	300	355	425	530	750	—	—
	1000V <sup>(1)</sup>	[kW]	110	132	132	160	160	200	220	280	400	—	—

(1) Power ratings at 50 Hz: Preferred values according to IEC 60072-1  
 (2) 415V: Values in () AC-3 and AC-4 lifespan -25%

		100/104-D,100S-D											
		115	140	140	180	180	210	250	300	420	630	860	
Coil Type:	Conventional	X	X	—	X	—	—	—	—	—	—	—	—
	Electronic — EI	X	—	X	—	X	X	X	X	X	X	X	X

Switching of Power Transformers, AC-6a (50 Hz)

Inrush Current	Rated transformer current	=n											
n=30	≤ 230V	[A]	60	70	70	85	85	105	125	150	210	—	—
	≤ 240V	[A]	60	70	70	85	85	105	125	150	210	—	—
	≤ 400V	[A]	60	70	70	85	85	105	125	150	210	—	—
	≤ 415V	[A]	60	70	70	85	85	105	125	150	210	—	—
	≤ 500V	[A]	60	70	70	85	85	105	125	150	210	—	—
	≤ 690V	[A]	60	70	70	85	85	105	125	150	210	—	—
	≤ 1000V	[A]	46	70	70	85	85	105	125	150	210	—	—
	230V	[kVA]	24	28	28	34	34	42	50	60	84	—	—
	240V	[kVA]	26	29	29	35	35	44	52	62	87	—	—
	400V	[kVA]	42	48	48	59	59	73	87	104	145	—	—
	415V	[kVA]	43	50	50	61	61	75	90	108	151	—	—
	500V	[kVA]	52	61	61	74	74	91	108	130	182	—	—
690V	[kVA]	72	84	84	102	102	125	149	179	251	—	—	
1000V	[kVA]	80	121	121	147	147	182	217	260	364	—	—	
n=20	≤ 690V	[A]	90	105	105	128	128	158	188	225	315	—	—
n=15	≤ 690V	[A]	120	140	140	170	170	210	250	300	420	—	—

60 Hz Peak Inrush/peak rated transformer current

n=30	[A]	60	70	70	85	85	105	125	150	210	—	—
	200V [kVA]	20.8	24.2	24.2	29.4	29.4	36.4	43.3	52.0	72.7	—	—
	208V [kVA]	21.6	25.2	25.2	30.6	30.6	37.8	45.0	54.0	75.7	—	—
	240V [kVA]	24.9	29.1	29.1	35.3	35.3	43.6	52.0	62.4	87.3	—	—
	480V [kVA]	49.9	58.2	58.2	70.7	70.7	87.3	104	125	175	—	—
	600V [kVA]	62.4	72.7	72.7	88.3	88.3	109	130	156	218	—	—
	660V [kVA]	68.6	80.0	80.0	97.2	97.2	120	143	171	240	—	—

60 Hz Peak Inrush/peak rated transformer current

n=20	[A]	90	105	105	128	128	158	188	225	315	—	—
	200V [kVA]	31.2	36.4	36.4	44.3	44.3	54.7	65.1	77.9	109	—	—
	208V [kVA]	32.4	37.8	37.8	46.1	46.1	56.9	67.7	81.1	113	—	—
	240V [kVA]	37.4	43.6	43.6	53.2	53.2	65.7	78.2	93.5	131	—	—
	480V [kVA]	74.8	87.3	87.3	106	106	131	156	187	262	—	—
	600V [kVA]	93.5	109	109	133	133	164	195	234	327	—	—
	660V [kVA]	103	120	120	146	146	181	215	257	360	—	—

60 Hz Peak Inrush/peak rated transformer current

n=15	[A]	120	140	140	170	170	210	250	300	420	—	—
	200V [kVA]	41.6	48.5	48.5	58.9	58.9	72.7	86.6	104	145	—	—
	208V [kVA]	43.2	50.4	50.4	61.2	61.2	75.7	90.1	108	151	—	—
	240V [kVA]	49.9	58.2	58.2	70.7	70.7	87.3	104	125	175	—	—
	480V [kVA]	99.8	116	116	141	141	175	208	249	349	—	—
	600V [kVA]	125	145	145	177	177	218	260	312	436	—	—
	660V [kVA]	137	160	160	194	194	240	286	343	480	—	—



			100/104-D,100S-D										
			115	140	140	180	180	210	250	300	420	630	860
Coil Type:	Conventional		X	X	—	X	—	—	—	—	—	—	—
	Electronic — EI		X	—	X	—	X	X	X	X	X	X	X
<b>Switching of 3-phase Capacitors, AC-6b (50 Hz)</b>													
Single capacitor 40°C	230V	[kVar]	45	70	70	70	70	98	98	125	139	—	—
	240V	[kVar]	47	73	73	73	73	102	102	131	145	—	—
	400V	[kVar]	78	121	121	121	121	170	170	218	242	—	—
	415V	[kVar]	81	126	126	126	126	176	176	226	252	—	—
	500V	[kVar]	97	152	152	152	152	212	212	273	303	—	—
	690V	[kVar]	134	209	209	209	209	293	293	376	418	—	—
	1000V	[kVar]	194	303	303	303	303	424	424	546	606	—	—
Single capacitor 60 °C	230V	[kVar]	38	59	59	59	59	84	84	106	119	—	—
	240V	[kVar]	39	61	61	61	61	87	87	111	124	—	—
	400V	[kVar]	65	102	102	102	102	145	145	184	206	—	—
	415V	[kVar]	68	106	106	106	106	151	151	191	214	—	—
	500V	[kVar]	82	127	127	127	127	182	182	230	258	—	—
	690V	[kVar]	113	176	176	176	176	251	251	318	356	—	—
	1000V	[kVar]	164	255	255	255	255	364	364	461	515	—	—
Group capacitors 40°C	230V	[kVar]	45	70	70	70	70	98	98	125	139	—	—
	240V	[kVar]	47	73	73	73	73	102	102	131	145	—	—
	400V	[kVar]	56	76	76	111	111	170	170	218	242	—	—
	415V	[kVar]	56	76	76	112	112	170	176	226	252	—	—
	500V	[kVar]	56	76	76	113	113	172	212	273	303	—	—
	690V	[kVar]	57	78	78	114	114	174	247	356	418	—	—
	1000V	[kVar]	58	79	79	116	116	177	251	361	606	—	—
Group capacitors 60 °C	230V	[kVar]	38	59	59	59	59	84	84	106	119	—	—
	240V	[kVar]	39	61	61	61	61	87	87	111	124	—	—
	400V	[kVar]	56	76	76	102	102	145	145	184	206	—	—
	415V	[kVar]	56	76	76	106	106	151	151	191	214	—	—
	500V	[kVar]	56	76	76	113	113	172	182	230	258	—	—
	690V	[kVar]	57	78	78	114	114	174	247	318	356	—	—
	1000V	[kVar]	58	79	79	116	116	177	251	361	515	—	—
60 Hz Single Capacitor — 40 °C	200V	[kVar]	39	61	61	61	61	85	85	109	121	—	—
	230V	[kVar]	45	70	70	70	70	98	98	125	139	—	—
	460V	[kVar]	89	139	139	139	139	195	195	251	279	—	—
	600V	[kVar]	116	182	182	182	182	255	255	327	364	—	—
60 Hz Group Capacitors — 40 °C	200V	[kVar]	39	61	61	61	61	85	85	109	121	—	—
	230V	[kVar]	45	70	70	70	70	98	98	125	139	—	—
	460V	[kVar]	56	76	76	112	112	171	195	251	279	—	—
	600V	[kVar]	57	77	77	114	114	173	246	327	364	—	—
<b>Switching of Lamps</b>													
Gas discharge lamps AC-5a, 40 °C													
open		[A]	144	225	225	225	225	315	315	405	450	—	—
enclosed		[A]	122	189	189	189	189	270	270	342	383	—	—
Individually compensated:													
Max. capacitance at expected													
Filament AC-5b	230/240V	[A]	120	140	140	170	170	210	250	300	420	—	—

			100/104-D,100S-D										
			115	140	140	180	180	210	250	300	420	630	860
Coil Type:	Conventional		X	X	—	X	—	—	—	—	—	—	—
	Electronic — EI		X	—	X	—	X	X	X	X	X	X	X
<b>Switching of Hermetically Sealed Cooling Compressor Motors - manual reset of overload release (50 Hz)</b>													
AC-8a	400V	[A]	192	210	210	—	—	—	—	—	—	—	—
	500V	[A]	192	192	210	—	—	—	—	—	—	—	—
	690V	[A]	192	192	210	—	—	—	—	—	—	—	—
<b>Switching of DC Loads</b>													
Non-inductive or slightly inductive loads or resistance furnaces DC-1, 60 °C													
1 pole	24V	[A]	135	210	210	210	210	300	300	380	425	—	—
	48/60V	[A]	135	210	210	210	210	300	300	380	425	—	—
	110V	[A]	135	210	210	210	210	300	300	380	425	—	—
	220V	[A]	3	3.3	3.3	3.3	3.3	4.9	4.9	4.9	5.2	—	—
	440V	[A]	0.6	0.75	0.75	0.75	0.75	1	1	1	1.2	—	—
2 poles in series	24V	[A]	135	210	210	210	210	300	300	380	425	—	—
	48/60V	[A]	135	210	210	210	210	300	300	380	425	—	—
	110V	[A]	135	210	210	210	210	300	300	380	425	—	—
	220V	[A]	135	210	210	210	210	300	300	380	425	—	—
	440V	[A]	3	3.3	3.3	3.3	3.3	4.9	4.9	4.9	5.2	—	—
3 poles in series	24V	[A]	135	210	210	210	210	300	300	380	425	—	—
	48/60V	[A]	135	210	210	210	210	300	300	380	425	—	—
	110V	[A]	135	210	210	210	210	300	300	380	425	—	—
	220V	[A]	135	210	210	210	210	300	300	380	425	—	—
	440V	[A]	11	11	11	11	11	14	14	14	15	—	—
Shunt-wound Motors, Starting, reverse current braking, reversing, stepping DC-3, 60°C													
3 poles in series	24V	[A]	135	210	210	210	210	300	300	380	425	—	—
	48/60V	[A]	135	210	210	210	210	300	300	380	425	—	—
	110V	[A]	135	210	210	210	210	300	300	380	425	—	—
	220V	[A]	135	210	210	210	210	300	300	380	425	—	—
	440V	[A]	3	3.5	3.5	3.5	3.5	4.1	4.1	4.1	5.8	—	—
Series-wound Motors, Starting, reverse current braking, reversing, stepping DC-5, 60 °C													
3 poles in series	24V	[A]	135	210	210	210	210	300	300	380	425	—	—
	48/60V	[A]	135	210	210	210	210	300	300	380	425	—	—
	110V	[A]	135	210	210	210	210	300	300	380	425	—	—
	220V	[A]	135	210	210	210	210	300	300	380	425	—	—
	440V	[A]	1.2	2.1	2.1	2.1	2.1	2.4	2.4	2.4	3	—	—
Short Time Withstand $I_{CW}$ , 60 °C	10 s	[A]	1040	1240	1360	1480	1480	2360	2520	2840	4700	6300	7000
<b>Resistance and Power Dissipation</b>													
Main current circuit resistance	[mΩ]		0.4	0.42	0.42	0.42	0.42	0.22	0.22	0.18	0.15	0.19	0.14
Power dissipation by all circuits at $I_e$ AC-3/400V	[W]		14.5	24.6	24.6	40.8	40.8	29.4	41.7	48.6	79.5	226.2	310.6
Total power dissipation At $I_e$ AC-3/400V	AC control	[W]	24.5(20.5)	34.6	30.6	50.8	46.8	35.4	47.7	54.6	86.5	256.2	340.6
	DC control	[W]	22.5(20.5)	32.6	30.6	48.8	46.8	35.4	47.7	54.6	86.5	256.2	340.6
<b>Lifespan</b>													
Mechanical AC control	[Million ops.]		10	10	10	10	10	10	10	10	10	2	2
Mechanical DC control	[Million ops.]		10	10	10	10	10	10	10	10	10	2	2
Electrical AC-3 (400 V)	[Million ops.]		1	1	1	1	1	1	1	1	1	—	—



			100/104-D,100S-D										
			115	140	140	180	180	210	250	300	420	630	860
Coil Type:	Conventional		X	X	—	X	—	—	—	—	—	—	—
	Electronic — EI		X	—	X	—	X	X	X	X	X	X	X
Weight													
AC	Non-Rev.	[kg (lbs)]	3.3(7.28) [3.8 (8.38)] <sup>(1)</sup>	3.3 (7.28)	3.8 (8.38)	3.3 (7.28)	3.8 (8.38)	7.5 (16.53)	7.5 (16.53)	7.5 (16.53)	7.5 (16.53)	28.6 (63)	28.6 (63)
	Rev.	[kg (lbs)]	3.14 (6.92)	—	—	—	—	—	—	—	—	—	—
DC	Non-Rev.	[kg (lbs)]	3.3(7.28) [3.8 (8.38)] <sup>(1)</sup>	3.3 (7.28)	3.8 (8.38)	3.3 (7.28)	3.8 (8.38)	7.5 (16.53)	7.5 (16.53)	7.5 (16.53)	7.5 (16.53)	28.6 (63)	28.6 (63)
	Rev.	[kg (lbs)]	3.22(7.1)	—	—	—	—	—	—	—	—	—	—

(1) Values in brackets refer to electronic coil (EI) version.

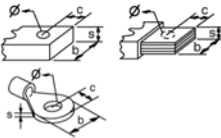
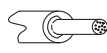
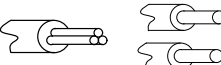
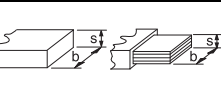
			100/104-D,100S-D									
			115	140	180	210	250	300	420	630	860	
Coil Type:	Conventional		X	X	X	—	—	—	—	—	—	—
	Electronic — EI		X	X	X	X	X	X	X	X	X	X
Conductor Cross Sections - Main Contacts Terminal type												
	b max.	[mm]	25			30			52			
	c max.	[mm]	12.5			15			22			
	s max.	[mm]	5			6			2 x 8			
	Ø min.	[mm]	8.3			10.5			13			
Recommended torque		[N·m]	22			43			68			
Recommended torque		[lb-in]	195			380			600			
With terminal lug kit			100-DL180 <sup>(1)</sup>			100-DL420 <sup>(1)</sup>			100-DL630		100-DL860	
Cross section per UL/CSA		[AWG]	6...300 MCM			(2x) 4...350 MCM			(2X) 2/0...500 MCM		(4X) 2/0...500 MCM	
Recommended torque		[lb-in]	88...106			375			400		400	
With Frame Terminal Block			100-DTB180 <sup>(1)</sup>			100-DTB420 <sup>(2)</sup>			—		—	
	top opening	[mm <sup>2</sup> ]	16...35			25...185			—		—	
	bottom opening	[mm <sup>2</sup> ]	16...95			25...185			—		—	
	top opening	[mm <sup>2</sup> ]	16...50			25...240			—		—	
	bottom opening	[mm <sup>2</sup> ]	16...120			25...240			—		—	
	b max.	[mm]	20			25			—		—	
	s top	[mm]	3...9			6...20			—		—	
	s bottom	[mm]	3...14			6...20			—		—	
Recommended torque		[N·m]	14			25			—		—	
Cross section per UL/CSA	top	[AWG]	6...1/0 AWG			4 AWG...600 MCM			—		—	
	bottom	[AWG]	6 AWG...250 MCM			4 AWG...600 MCM			—		—	
Recommended torque		[lb-in]	124			220			—		—	

(1) Hexagonal socket screw

(2) Pozidriv No. 2 / Blade No. 3 screw

**Short-Circuit Coordination Data**

See [www.rockwellautomation.com/global/support/global-sccr.page](http://www.rockwellautomation.com/global/support/global-sccr.page) for complete short-circuit current ratings.

		100/104-D,100S-D									
		115	140/180	140	180	210	250	300	420	630	860
Coil Type:	Conventional	X	X	—	—	—	—	—	—	—	—
	Electronic - EI	X	—	X	X	X	X	X	X	X	X
<b>Short Circuit Coordination (Max. Fuse or Circuit Breaker Rating) Per IEC 60947-4-1 (contactor and fuses only)</b>											
DIN Fuses- gG, gL		50 kA Available Fault Current									
Type"1"(690V)	[A]	250	315	315	355	500	500	630	630	TBD	TBD
Type"2"(400V)	[A]	200	250	250	315	400	400	500	500	TBD	TBD
Type"2"(690V)	[A]	200	250	250	315	400	400	500	500	TBD	TBD
BS88Fuses											
Type"1"(415V)	[A]	200	250	250	250	355	355	450	630	TBD	TBD
Type"2"(415V)	[A]	200	250	250	250	355	355	450	560	TBD	TBD
<b>UL Class K5 and RK5 Fuses</b>		10 kA Available Fault Current									
UL Listed Combination (600V)	[A]	250	350/450	350	450	500	—	—	—	—	—
<b>UL Class L Fuses</b>		18 kA Available Fault Current									
UL Listed Combination (600V)	[A]	—	—	—	—	—	700	700	1000	—	—
<b>UL Class L Fuses</b>		30 kA Available Fault Current									
UL Listed Combination (600V)	[A]	—	—	—	—	—	—	—	—	2000	—
<b>UL Class L Fuses</b>		42 kA Available Fault Current									
UL Listed Combination (600V)	[A]	—	—	—	—	—	—	—	—	—	2500
<b>UL Class J and CSA HRCI-J Fuses</b>		100 kA Available Fault Current									
UL verified combination to IEC60947-4-1 "Type2"	[A]	200	250/300	250	300	400	400	500	600	—	—
<b>UL Inverse-Time Circuit Breaker</b>		10 kA Available Fault Current									
UL Listed Combination (600V)	[A]	150	200/250	200	250	300	—	—	—	—	—
<b>UL Inverse-Time Circuit Breaker</b>		18 kA Available Fault Current									
UL Listed Combination (600V)	[A]	—	—	—	—	—	350	400	500	—	—
<b>UL Inverse-Time Circuit Breaker</b>		25 kA Available Fault Current									
UL Listed Combination (600Y/347V)	[A]	125	200	200	200	250	—	—	—	—	—
<b>UL Inverse-Time Circuit Breaker</b>		30 kA Available Fault Current									
UL Listed Combination (600V)	[A]	—	—	—	—	—	400	400	600	1200	—
<b>UL Inverse-Time Circuit Breaker</b>		42 kA Available Fault Current									
UL Listed Combination (600V)	[A]	—	—	—	—	—	—	—	—	—	1200
<b>UL Inverse-Time Circuit Breaker</b>		65 kA Available Fault Current									
UL Listed Combination (480V)	[A]	125	200	200	200	250	400	400	600	—	—
<b>UL Inverse-Time Circuit Breaker</b>		65kAAvailable Fault Current									
UL Listed Combination (480V)	[A]	125	200	200	200	250	400	400	600	—	—



**Coil Data**

			100/104-D,100S-D										
			115	140/180	115	140	180	210	250	300	420	630	860
<b>Coil Type:</b>	<b>Conventional</b>		X	X	—	—	—	—	—	—	—	—	—
	<b>Electronic - EI</b>		X	—	X	X	X	X	X	X	X	X	X
<b>Operating Limits</b>													
50 Hz, 60 Hz, 50/60 Hz	pick-up	[x U <sub>s</sub> ]	0.85...1.1			0.85...1.1			0.8...1.1				
	dropout	[x U <sub>s</sub> ]	0.3...0.6			0.3...0.5			0.1...0.8				
DC control	pick-up	[x U <sub>s</sub> ]	0.85...1.1			0.85...1.1			0.85...1.1				
	dropout	[x U <sub>s</sub> ]	0.3...0.6			0.3...0.5			0.1...0.8				
<b>Coil Consumption</b>													
50 Hz, 60 Hz, 50/60 Hz	pick-up	[VA/W]	650/310			380/240 <sup>(1)</sup>			490/270 <sup>(1)</sup>			1915/1720	
	hold-in	[VA/W]	50/10			13/6			18/7			33/30	
DC control	pick-up	[W]	540			265 <sup>(1)</sup>			340 <sup>(1)</sup>			1980 <sup>(1)</sup>	
	hold-in	[W]	8			6			7			30	
<b>Operating Times</b>													
AC	closing delay	[ms]	20...47			20...45			60...100				
	opening delay	[ms]	6...12			25...110			70...145				
With RC module	closing delay	[ms]	9...18			—			—				
DC	opening delay	[ms]	27...47			25...50			60...100				
	closing delay	[ms]	12...20			35...110			70...145				
With integrated diode	opening delay	[ms]	12...20			—			—				
With external diode	opening delay	[ms]	—			—			—				

(1) Electronic coil drives are designed to minimize power requirements, but this control may exhibit a higher inrush (540 W, < 10 ms) when energizing. This must be taken into account for the proper sizing of supply devices, all-or-nothing relays and cross-sections of coil supply lines. Please contact your local Rockwell Automation sales office or Allen-Bradley distributor for detailed information.

**Auxiliary Contacts, Auxiliary Contact Blocks, and Pneumatic Timers**

			Side-mounted		
			Conventional	Bifurcated	Electronically Compatible
<b>Switching of AC Loads</b>					
AC-12 I <sub>th</sub>	at 40 °C	[A]	16	10	0.1
	at 60 °C	[A]	12	6	at 250V
AC-15 at rated voltage of	24V	[A]	5.5	3	(1...100 mA) at 3...125V
	42/48V	[A]	5.5	3	
	120V	[A]	5.5	3	
	230V	[A]	5.5	3	
	240V	[A]	5	3	
	400V	[A]	3	2	
	415V	[A]	2.5	2	
	500V	[A]	1.6	1.2	
690V	[A]	1	0.7		
<b>Switching of DC Loads</b>					
DC-12 L/R < 1 ms resistive loads at	24V DC	[A]	16	16	—
	48V DC	[A]	9	9	—
	110V DC	[A]	3.5	3.5	—
	220V DC	[A]	0.55	0.55	—
	440V DC	[A]	0.2	0.2	—

			Side-mounted		
			Conventional	Bifurcated	Electronically Compatible
DC-14L/R <15 ms inductive loads with economy resistor in series at	24V DC	[A]	9	9	—
	48V DC	[A]	5	5	—
	110V DC	[A]	2	2	—
	220V DC	[A]	0.4	0.4	—
	440V DC	[A]	0.16	0.1	—
DC-13 switching electromagnets at	24V DC	[A]	5	5	(1...100 mA) at 3...125V
	48V DC	[A]	2	2	
	110V DC	[A]	0.7	0.7	
	220V DC	[A]	0.25	0.25	
	440V DC	[A]	0.12	0.12	
Fuse gG					
		[A]	16	16	—
		[A]	16	16	—
Protective Separation per IEC 60947-1, Annex N			between load and auxiliary circuit 440V		
Min. switching capacity according to IEC 60947-5-4			17V/10 mA	5V/2 mA (1 million ops.)	3V/1 mA
Load Carrying Capacity per UL/CSA					
Rated voltage	AC	[V]	max.600		max.250
Continuous rating	40 °C	[A]	10 General purpose		0.1
Switching capacity	AC	[A]	Heavy pilot duty (A600)		0.1
Rated voltage	DC	[V]	max.600		max.250
Switching capacity	DC	[A]	Standard pilot duty (P600)	Standard pilot duty (Q600)	0.1

**General**

Attribute		Value
<b>Rated Isolation Voltage U<sub>i</sub></b>		
IEC	[V]	1000
UL,CSA	[V]	600
Rated Impulse Voltage Withstand U <sub>imp</sub>	[kV]	12
<b>Rated Voltage U<sub>e</sub></b>		
AC 50/60 Hz	[V]	230, 240, 400, 415, 500, 690, 1000
DC	[V]	24, 48, 110, 220, 440
Insulation Class of the Coil		Class B per VDE 0660, Table 22
Rated coil frequency		AC 50 Hz; 50/60Hz DC
Ambient Temperature		
Storage	[°C]	-40...+80
Operation at rated voltage	[°C]	-25...+60
at 70 °C		15% current reduction against 60 °C values
Climatic Withstand		IEC 60068-2-30
Max. Altitude of Installation Site	[m]	2000NN, per IEC60947-4
Protection Class		IP00 IEC 60529/DIN 40050
Single contactor cover		IP10 IEC 60529/DIN 40050
Contact with frame terminal block		IP20 IEC 60529/DIN 40050
Auxiliary contact		IP20 IEC60529/DIN 40050
Protection against Accidental Contact		Finger-and back-of-hand proof per VDE 0106, part 100
Resistance to Shock		IEC 60068-2-27
Resistance to Vibration		IEC 60068-2-6
Mirror Contacts IEC60947-4 Annex F		100-D...+2 x 100-DS1-11; 100S-D...+2 x 100S-DS1-11

## Standards Compliance and Certifications

### 100-D IEC Contactors

Standards Compliance	Certifications
IEC 60947-4-1	CE Marked
IEC 60947 Type "2" Coordination	CCC (115...180 A - conventional coil; 115...860 A - electronic coil)
CSA 22.2 No. 14	cULus Listed (File No. E 41850, Guide NLDX, NLDX7)
UL 508	

### 100S-D Safety Contactors

Standards Compliance	Certifications
IEC 60947-4-1	CE Marked
IEC 60947-4 Annex F	cULus Listed (File No. E 41850, Guide NLDX, NLDX7)
IEC 60947 Type "2" Coordination	SUVA Certified
CSA C22.2 No. 14	CCC (115...180 A - conventional coil; 115...860 A - electronic coil)
UL 508	

## Life-Load Curves

Figure 30 - AC-3, AC-1

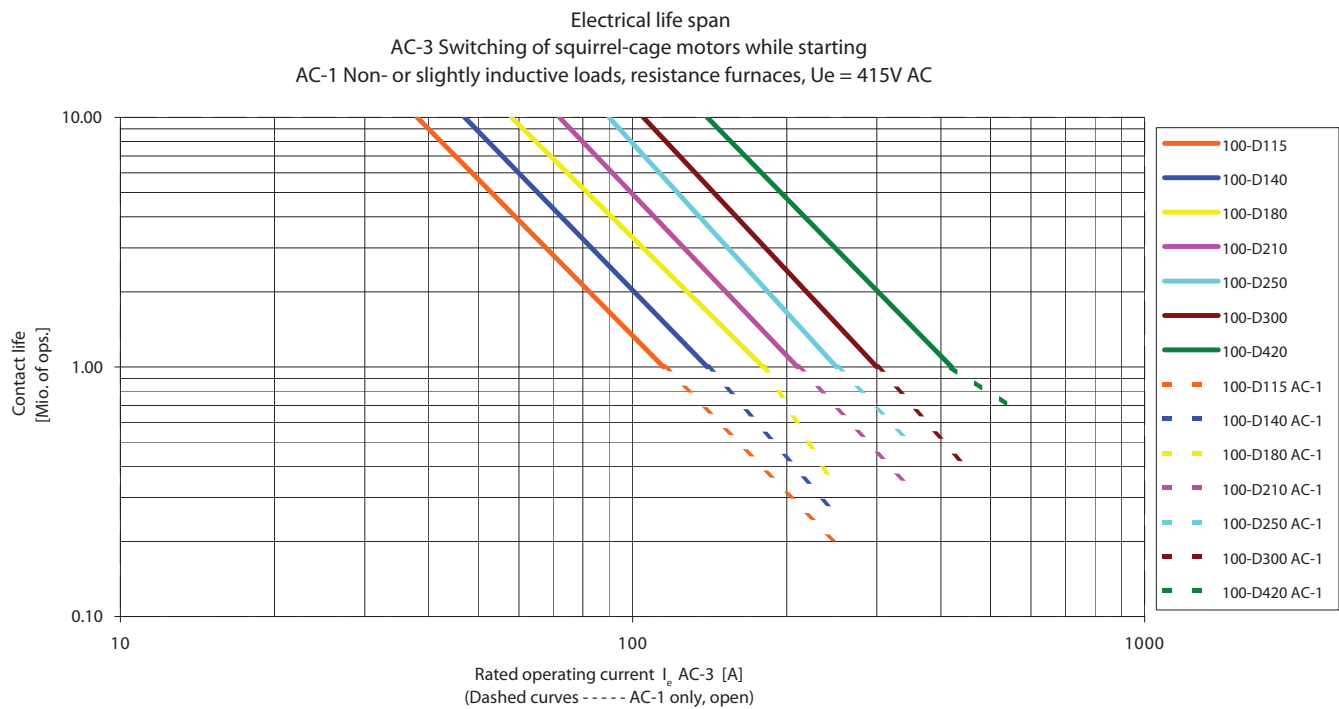

Figure 31 - AC-4

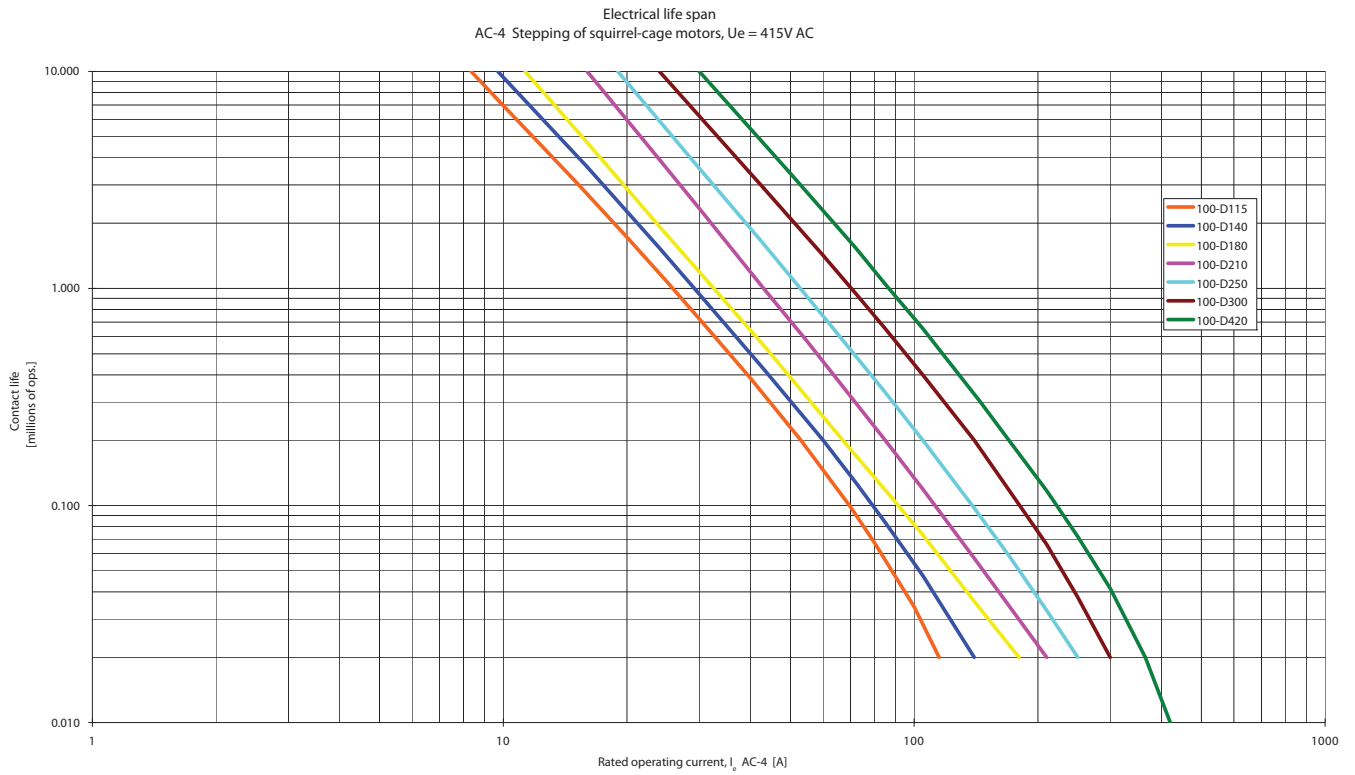
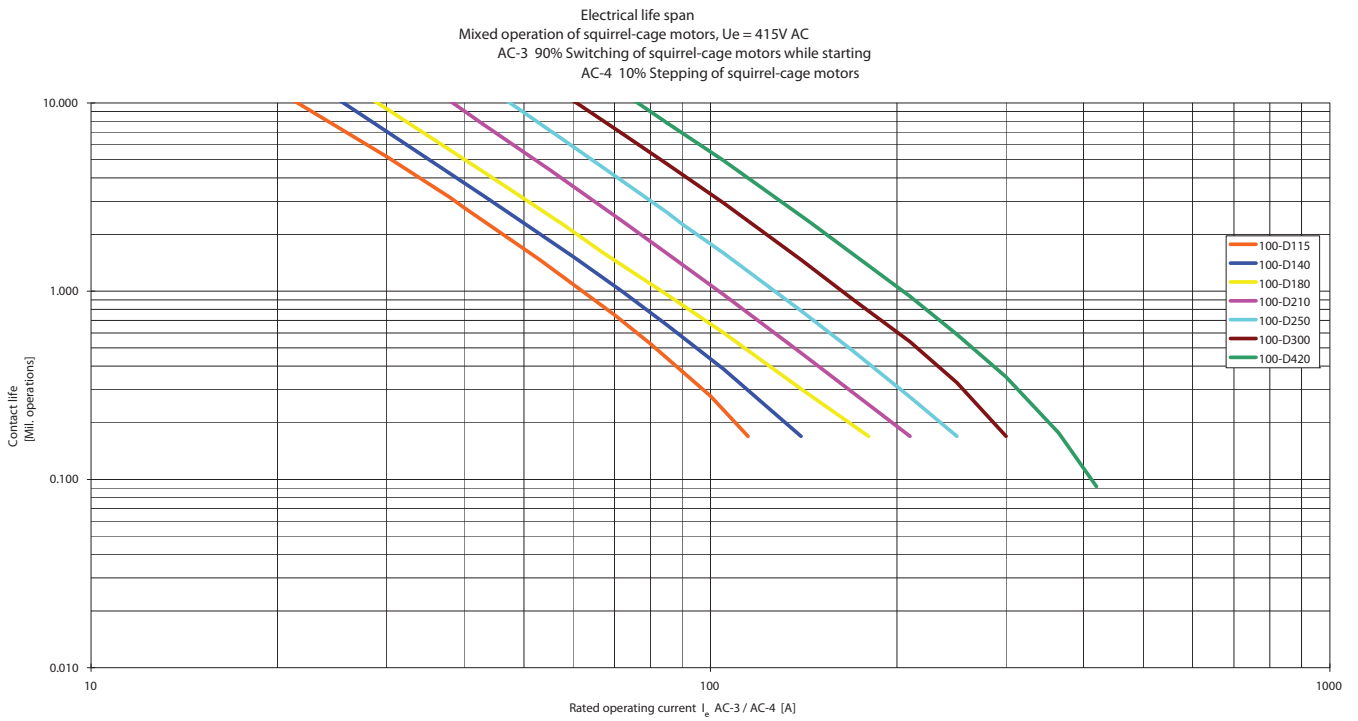

Figure 32 - AC-3 90% and AC-4 10%



# Approximate Dimensions

Dimensions are shown in millimeters (inches). Dimensions are not intended for manufacturing purposes.

## Bulletin 100-D/104-D, 100S-D Approximate Dimensions

**Figure 33 - Bulletin 100-D/100S-D Contactors and Accessories**

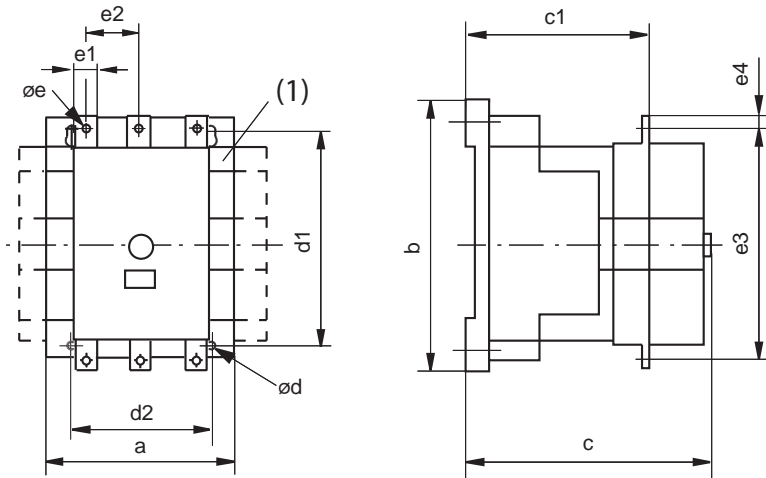

(1) Conventional DC coil contactors will have an additional auxiliary contact block that will add 13.5 mm to the “a” dimension on the right-hand side.

**Figure 34 - Mounting Position, 100-D, 100S-D, 104-D Contactors**

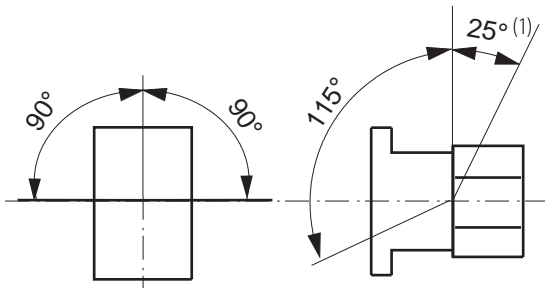

(1) Applies only to conventional single frequency, conventional DC and electronic coils.

### Contactors with Accessories

Contactor with		mm
Auxiliary contact block	100-DS1...	a
	100-DS2...	a + 13.5 each
Mechanical Interlock	100-DM...	a + a
Frame terminal block	100-DTB110	b + 7 each
	100-DTB180	b + 7 each
	100-DTB420	b + 8.5 each
Label holder		c...+5

### AC and DC Contactors

Cat. No.	a	b	c	c1	Ø d	d1	d2	Ø e	e1	e2	e3	e4
100-D115E...100-D180E, 100-D115, 100-D140, 100-D180	120	170	156	110.5	5.2	145	100	8.5	20	39	160	10
100-D210E...100-D420E	155	205	180	110.5	6.5	180	130	10.4	25	48	193	12.5
100-D630E...100-D860E	255	310	265	110.5	10	230	225	M12	40	70	291	22
100S-D115E...100S-D180E, 100S-D115, 100S-D140, 100S-D180	120	170	156	110.5	5.2	145	100	8.5	20	39	160	10
100S-D210E...100S-D420E	155	205	180	110.5	6.5	180	130	10.5	25	48	193	12.5
100S-D630E...100S-D860E	255	310	265	110.5	10	230	225	M12	40	70	291	22

Notes:





## Product Selection—100-G Contactors

- 315...710 kW, 400V
- 350...900 Hp, 460/575V
- 3-Pole contactors
- 4th add-on neutral switching pole AC and DC control
- Horizontal and vertical interlocking Mechanical latching
- Meets IEC, CE, and cULus Standards and Certifications



The Bulletin 100-G contactor product family provides reliable switching of motor loads up to 1200 A. A complete range of accessories including auxiliary contacts, mechanical latches, horizontal and vertical interlocks, and 4th add-on neutral switching poles provides maximum flexibility to meet a wide variety of application requirements.

### AC and DC Control

Rated Operational Current $I_e$ [A]	Ratings for switching AC motors - AC-2, AC-3									Auxiliary Contacts		Cat No.
	kW (50 Hz) <sup>(1)</sup>				Hp (60 Hz)				kW (50 Hz)			
40 °C	230V	400V	500V	690V	200V	230V	460V	575V	400	N.O.	N.C.	
AC-1 (690V)												
760	160	315	400	500	150	150	350	350	315	2	2	100-G550⊗22
1000	220	400	500	630	200	250	500	500	400	2	2	100-G700⊗22
1100	280	500	630	710	250	300	600	600	500	2	2	100-G860⊗22
1200	315	560	750	850	—	—	—	—	560	2 <sup>(2)</sup>	2	<sup>(3)</sup> 100-G1000⊗12
1350	375	710	900	1000	450	450	900	900	710	2	2	100-G1200⊗12

(1) Preferred values according to IEC 60072-1.

(2) 1 N.O. contact used in control circuit

(3) No UL/cUL

### Coil Voltage Codes







The Cat. No. as listed is incomplete. Select a coil voltage code from the table below to complete the Cat. No. Example: 120V, 60 Hz: Cat. No. 100-G550⊗22 becomes Cat. No.100-G550KD22.

AC Voltages [V], Conventional Coil	100...110	110...120	200...220	220...240	345...380	380...415	400...440	440...480	
100-G550...100-G860	50/60 Hz	—	KD	—	KF	—	KN	—	KB
	DC	KD	—	KF	—	KN	—	KB	—

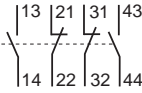
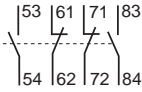
AC Voltages [V], Conventional Coil	110...115	110	220...230	220	240	380...400	440	480	
100-G1000...100-G1200	50/60 Hz	KD	—	KF	—	KA	KN	KB	KU
	DC	—	ZD <sup>(1)</sup>	—	ZA <sup>(1)</sup>	—	—	—	—

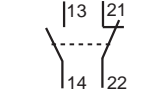
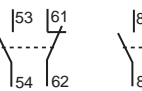
(1) Consult your local Rockwell Automation sales office or Allen-Bradley distributor.

# Accessories

	Description	For Use With	Cat. No. <sup>(1)</sup>	
	<p>Auxiliary Contact Block</p> <ul style="list-style-type: none"> <li>For mounting between T1 &amp; T2 or between T2 &amp; T3</li> <li>Adjustable; provides normal, delayed, or overlapping contacts</li> <li>Max. two blocks/contactor</li> <li>Alternate terminal marking tags included</li> <li>2 N.O and 2 N.C. contacts</li> </ul>	  <p>Standard terminal marking for mounting between T1 &amp; T2</p> <p>Alternate terminal marking for mounting between T2 &amp; T3</p>	100-G550...100-G860	100-EF22
	<p>Auxiliary Contact Block</p> <ul style="list-style-type: none"> <li>For side mounting on either side of the contactor</li> <li>Max. four blocks/contactor</li> <li>Alternate terminal marking tags included</li> <li>1 N.O and 1 N.C. contact</li> </ul>	  <p>Standard terminal marking</p> <p>Alternate terminal markings</p>	100-G1000...100-G1200	100-EB11
	<p>Fourth Add-On Neutral Switching Pole</p> <ul style="list-style-type: none"> <li>Left- or right-side mountable</li> <li>Note: no UL/cUL</li> </ul>	$I_{th}$ AC-1 500 A	100-G500, 100-G700, 100-G860	100-NP800-5
		$I_{th}$ AC-1 1000 A	100-G700, 100-G860	100-NP1000-6
			100-G1000, 100-G1200	100-NP1000-7
	<p>Mechanical Latch</p> <ul style="list-style-type: none"> <li>Mechanical life: 0.5 million operations</li> <li>Direct and impulse Control</li> </ul>	Direct and Impulse Contact control	100-G550	100-FLAM5⊗
		Direct and Impulse Contact control	100-G700, 100-G860	100-FLAM6⊗
	Mechanical Interlock — Horizontal		100-G550 to 100-G550	100-MC00-5H
			100-G550 to 100-G700 or 100-G860	100-MC00-56H
			100-G700 or 100-G860 to 100-G700 or 100-G860	100-MC00-6H
			100-G700 or 100-G860 to 100-G1000 or 100-G1200	100-MC0067H
			100-G1000 or 100-G1200 to 100-G1000 or 100-G1200	100-MC00-7H
	Mechanical Interlock — Vertical		100-G550 to 100-G550	100-MC00-5V
			100-G550 to 100-G700 or 100-G860	100-MC00-56V
			100-G700 or 100-G860 to 100-G700 or 100-G860	100-MC00-6V
			100-G700 or 100-G860 to 100-G1000 or 100-G1200	100-MC0067V
			100-G1000 or 100-G1200 to 100-G1000 or 100-G1200	100-MC00-7V



(1) Package Quantity = 1

## Coil Voltage Codes

The Cat. No. as listed is incomplete. Select a coil voltage code from the table below to complete the Cat. No. Example: Cat. No. 100-FLAM5⊗ becomes Cat. No.100-FLAM5KD.

For Use With	[V]	110...120	220...240	380...415	440...480
100-G550...-G860	50/60 Hz	KD	KF	KN	KB

# Renewal Parts

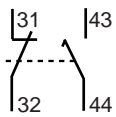
	Description	For Use With	Cat. No.
 <p>Arcing Chamber</p> <ul style="list-style-type: none"> <li>For 3 poles</li> </ul>		100-G550	100-AC550
		100-G700, 100-G860	100-AC860
 <p>Main Contact Set</p> <ul style="list-style-type: none"> <li>Set for 1 pole</li> </ul>		100-G550	100-CP550
		100-G700	100-CP700
		100-G860	100-CP860
		100-G1000	100-CP1000
		100-G1200	100-CP1200
 <p>Auxiliary Contact Block</p> <ul style="list-style-type: none"> <li>Special 2-pole design: 1 N.O. delayed make, 1 N.C. contact</li> <li>N.O. delayed make contact used for operation of the feeder/group coil mechanism</li> <li>One contact block supplied standard with contactor</li> </ul>		100-G1000, 100-G1200	100-EB11DC

## Coils and Supply Modules

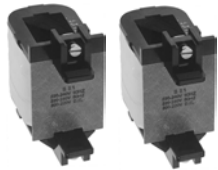

AC Standard Control Voltages 50/60 Hz	DC Standard Control Voltage	Coil Code	100-G550		100-G700...100-G860	
			Cat. No.	Cat. No.	Cat. No.	Cat. No.
110...120V	100...110V	KD	TX734	TXS734	TY734	TYS734
220...240V	200...220V	KF	TX747	TXS747	TY747	TYS747
380...415V	345...380V	KN	TX779	TXS779	TY779	TYS779
440...480V	400...440V	KB	TX780	TXS780	TY780	TYS780

AC Standard Control Voltages 50/60 Hz	Coil Code	100-G1000...100-G1200	
		Coil Cat. No. <sup>(1)</sup>	Supply Module Cat. No.
110...115V	KD	TZ734	TZS734
220...230V	KF	TZ747	TZS747
380...400V	KN	TZ779	TZS779
440V	KB	TZ780	TZS780
480V	KU	TZ781	TZS781

(1) Coils sold in pairs.

# Specifications

## Electrical Data

		100-G550	100-G700	100-G860	100-G1000	100-G1200	
<b>AC-1, Three-phase Switching-IEC</b>							
<b>Ambient temperature: 40 °C</b>							
$I_e$	≤690V	[A]	760	1000	1100	1200	1350
	≤230V	[kW]	303	398	438	478	538
	≤240V	[kW]	316	416	457	499	561
	≤400V	[kW]	527	693	762	831	935
	≤415V	[kW]	546	719	791	863	970
	≤500V	[kW]	658	866	953	1039	1169
	≤690V	[kW]	908	1195	1315	1434	1613
<b>Ambient temperature: 60 °C</b>							
$I_e$	≤690V	[A]	605	800	870	960	1,085
	≤230V	[kW]	241	319	347	382	432
	≤240V	[kW]	251	333	362	399	451
	≤400V	[kW]	419	554	603	665	752
	≤415V	[kW]	435	575	625	690	780
	≤500V	[kW]	524	693	753	831	940
	≤690V	[kW]	723	956	1040	1147	1297
Continuous Current- UL/CSA General Purpose Rating 40 °C		[A]	520	700	810	—	1215
<b>Switching of 3-phase Motors-IEC</b>							
AC-2, AC-3	230/240V	[A]	550	700	860	1000	1200
50Hz/60°C	400/415V	[A]	550	700	860	1000	1200
	500V	[A]	550	700	860	1000	1200
	690V	[A]	500	630	700	860	1000
	230V	[kW]	179	228	280	326	391
	240V	[kW]	187	238	293	340	408
	400V	[kW]	312	414	509	592	710
	415V	[kW]	324	430	528	628	737
	500V	[kW]	407	518	636	756	888
	690V	[kW]	510	657	730	897	1043
<b>AC-4 at 200 000 operations</b>							
50Hz	230/240V	[A]	140	180	210	260	300
	400/415V	[A]	140	180	210	260	300
	230V	[kW]	45	57	67	83	97
	240V	[kW]	47	60	70	87	101
	400V	[kW]	78	101	118	146	170
	415V	[kW]	81	105	122	151	176
<b>AC-4, Squirrel-cage motors with reversing and jogging at 20,000 (25,000), operations</b>							
	230/240V	[A]	360	430	520	(630)	(700)
	400/415V <sup>(1)</sup>	[A]	350	420	520	(630)	(700)
	230V	[kW]	116	139	170	(205)	(228)
	240V	[kW]	120	151	177	(214)	(245)
	400V	[kW]	198	238	295	(357)	(414)
	415V	[kW]	206	247	300	(359)	(424)

(1) At rated Voltage 415V and rated current: Lifespan -25%.

			100-G550	100-G700	100-G860	100-G1000	100-G1200
<b>Switching of 3-phase Motors-UL/CSA</b>							
60Hz/60°C	200V	[A]	414	552	692	—	1185
	230V	[A]	360	602	722	—	1130
	460V	[A]	414	590	708	—	1062
	575V	[A]	336	472	576	—	864
	200V	[Hp]	150	200	250	—	450
	230V	[Hp]	150	250	300	—	450
	460V	[Hp]	350	500	600	—	900
	575V	[Hp]	350	500	600	—	900
<b>Rated making capacity</b>							
AC-3 $I_e$	≤415V	[A]	5500	7000	8600	10000	12000
	≤500V	[A]	5500	7000	8600	10000	12000
	≤690V	[A]	5500	7000	8600	10000	12000
<b>Rated making capacity</b>							
AC-3 $I_e$	≤240V	[A]	4400	5600	6900	8000	9600
	≤400V	[A]	4400	5600	6900	8000	9600
	≤415V	[A]	4400	5600	6900	8000	9600
	≤500V	[A]	4400	5600	6900	8000	9600
	≤690V	[A]	4000	5100	5600	6900	8000
<b>Star-Delta Starting</b>							
50 Hz	230V	[A]	953	1212	1490	1732	2078
	240V	[A]	953	1212	1490	1732	2078
	400V	[A]	953	1212	1490	1732	2078
	415V	[A]	953	1212	1490	1732	2078
	500V	[A]	953	1212	1490	1732	2078
	690V	[A]	831	1091	1195	1490	1732
	230V	[kW]	310	395	485	565	677
	240V	[kW]	324	412	507	589	707
	400V	[kW]	540	717	882	1025	1250
	415V	[kW]	561	745	915	1088	1278
	500V	[kW]	705	897	1102	1309	1538
	690V	[kW]	883	1138	1247	1554	2078
	<b>Wye-Delta Starting</b>						
60 Hz	230V	[Hp]	250	400	500	650	750
	460V	[Hp]	600	800	1000	1300	1500
	575V	[Hp]	600	800	1000	1500	1500
<b>Short-circuit Protection of Contactors without Overload Relay</b>							
Fuse gG (aM) Type 1 coordination (per IEC 60947-4-1)	500V	[A]	(630)	800	1000	1000	1250
	690V	[A]	(630)	800	1000	1000	1000
<b>Switching of Three-phase Capacitor Inductivity of dispatching between parallel switched capacitor: min. 6 pH</b>							
Single capacitors — 40 °C	230V	[kVar]	180	220	250	290	330
	240V	[kVar]	200	250	300	325	360
	400V	[kVar]	320	400	450	500	575
	415V	[kVar]	350	430	500	550	630
	500V	[kVar]	450	520	600	660	750
	690V	[kVar]	580	700	800	875	1000

## 100-G Contactors

			100-G550	100-G700	100-G860	100-G1000	100-G1200
Single capacitors — 55 °C	230V	[kVar]	150	180	220	275	325
	240V	[kVar]	170	200	260	300	350
	400V	[kVar]	280	330	400	460	550
	415V	[kVar]	300	360	450	500	600
	500V	[kVar]	360	420	540	600	720
	690V	[kVar]	500	580	720	800	950

Cat. No.			100-G550	100-G700	100-G860	100-G1000	100-G1200
<b>Ratings for Switching Capacitor Banks</b>							
40 °C	230V	[kVar]	180	220	250	290	330
	240V	[kVar]	200	250	300	325	360
	400V	[kVar]	320	400	450	500	575
	415V	[kVar]	350	430	500	550	430
	500V	[kVar]	450	520	600	660	750
	690V	[kVar]	580	700	800	875	1000
55 °C	230V	[kVar]	150	180	220	275	325
	240V	[kVar]	170	200	260	300	350
	400V	[kVar]	280	330	400	460	550
	415V	[kVar]	300	360	450	500	600
	500V	[kVar]	360	420	540	600	720
	690V	[kVar]	500	580	720	800	950

### DC Switching

#### Switching of non-or slightly inductive loads, resistance furnaces; DC-1 at 60°C

1 Pole	24/48V	[A]	645	760	930	1020	1150
2 Poles in series	24/48V	[A]	645	760	930	1020	1150
3 Poles in series	24/48V	[A]	645	760	930	1020	1150
	110V	[A]	480	560	630	800	900
	220V	[A]	315	400	450	500	600

### Shunt-Wound Motors

#### Starting, plugging, reversing, plugging; DC-3 at 60 °C

3 Poles in series	24/48V	[A]	605	800	870	960	1085
-------------------	--------	-----	-----	-----	-----	-----	------

### Series-Wound Motors

Starting, plugging, reversing, plugging; DC-5 at 60°C

3 Poles in series	24/48V	[A]	605	800	870	960	1085
-------------------	--------	-----	-----	-----	-----	-----	------

### Lighting Loads; Elec. Discharge Lamps-AC-5a,

Non-Compensated	[A]	450	570	700	850	1000
Compensated	[A]	360	460	550	660	800
Incandescent Lamps-AC-5b, Electrical Endurance @100000 ops	[A]	315	440	500	560	630

### Switching Power Transformers AC-6a

Inrush = $n \cdot I_e$	[A]	7440	9450	11700	13500	16200	
$I_e$ Rated transformer current	[A]	248	315	390	450	540	
n=30	400VAC	[kVA]	172	218	270	312	374
	500VAC	[kVA]	215	273	338	390	468
	690VAC	[kVA]	269	339	376	538	645
n=20	[A]	371	472	580	675	810	
n=15	[A]	435	630	774	900	1080	

Cat. No.			100-G550	100-G700	100-G860	100-G1000	100-G1200
Rated Short-Time Withstand, $I_{CW}$ 60 °C	1s	[A]	5500	7000	8000	10000	12000
	4s	[A]	5500	7000	8000	10000	12000
	10s	[A]	4400	5600	6900	8000	9600
	15s	[A]	3800	5000	6000	7400	8500
	60s	[A]	2300	2800	3400	4000	4800
	240s	[A]	1300	1800	2000	2300	2700
	900s	[A]	850	1150	1350	1600	1900
Minimum cooling time at zero current		[Min.]	60	60	60	60	60
<b>Resistance and Energy Dissipation</b>							
Main circuit resistance		[mΩ]	0.11	0.1	0.08	0.06	0.05
Total energy dissipation at $I_e$ AC-3		[W]	99	147	177	180	216
Excess energy dissipation at $I_e$ AC-3	AC Control	[W]	110	172	202	250	286
	DC Control	[W]	109	169	199	240	276

**Mechanical Data**

Cat. No.			100-G550	100-G700	100-G860	100-G1000	100-G1200
Mechanical Life	AC Control	[Million operations]	5	5	5	1	1
	DC Control	[Million operations]	5	5	5	1	1
Shipping Weights	AC Control	[kg]	13.8	26.4	28.4	50.3	53.4
		[lb]	30.4	58.1	62.5	110.8	117.6
	DC Control	[kg]	13.8	26.4	28.4	50.3	53.4
		[lb]	30.4	58.1	62.5	110.8	117.6

**Terminals**

Terminal Dimensions	[mm]	6 x 40	8 x 50	8 x 50	10 x 50	10 x 60
Terminal screw hole size	[mm]	(1) x Ø13	(1) x Ø13	(1) x Ø15	(2) x Ø13	(2) x Ø13
Terminations-Power Type		Hexagonal Bolt				

**Direct Connection**

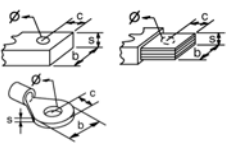
	b max.	[mm]	50	60	60	60	60
	c max.	[mm]	20	20	25	25	25
	s max.	[mm]	2x5	2x5	2x6	2x6	2x8
	Ø min.	[mm]	12.5	13	15	2x13	2x13
Recommended Torque		[N·m]	50	60	75	60	60
		[ft.-lb]	37	44	55	44	44

**Conductor/Wire Terminations**

Busbar (Width)	[mm]	40	50	50	50	60
Hex screw	[in]	1/2	3/8	3/8	3/8	3/8
Recommended Torque	[N·m]	42	62	62	56	56
	[lb-in]	375	550	550	500	500
Auxiliary Contact	[mm <sup>2</sup> ]	(2) x 2.5	(2) x 2.5	(2) x 2.5	(2) x 2.5	(2) x 2.5
Coils	[mm <sup>2</sup> ]	(2) x 2.5	(2) x 2.5	(2) x 2.5	(2) x 2.5	(2) x 2.5

**Coil Data**

Cat. No.		100-G550	100-G700	100-G860	100-G1000	100-G1200
<b>Operating Limits</b>						
AC-50 Hz	Pick-up	[x U <sub>s</sub> ]	0.85...1.1			
	Drop-out	[x U <sub>s</sub> ]	0.2...0.5	0.2...0.75	0.1...0.6	
AC-60 Hz	Pick-up	[x U <sub>s</sub> ]	0.85...1.1			
	Drop-out	[x U <sub>s</sub> ]	0.2...0.5	0.2...0.75	0.1...0.6	
DC Control	Pick-up	[x U <sub>s</sub> ]	0.85...1.1			
	Drop-out	[x U <sub>s</sub> ]	0.2...0.5	0.2...0.75	0.1...0.6	
<b>Pickup and Holding Power</b>						
AC-50 Hz	Pick-up	[VA]	800...950	1350...1600	2400	
	Hold-in	[VA]	9...11	21...25	70	
AC-60 Hz	Pick-up	[VA]	800...950	1350...1600	2400	
	Hold-in	[VA]	9...11	21...25	70	
DC Control	Pick-up	[W]	700...850	1300...1550	2100	
	Hold-in	[W]	8...10	18...22	60	
<b>Operating Times: Switching Delay</b>						
AC	Making delay	[ms]	50...100			50...100
	Breaking delay	[ms]	20...50 <sup>(1)</sup> /150...200/500...1000 <sup>(2)</sup>			25...50
DC	Making delay	[ms]	50...100			50...100
	Breaking delay	[ms]	20...50 <sup>(1)</sup> /150...200/500...1000 <sup>(2)</sup>			25...50

- (1) Accelerates
- (2) Delays

**Auxiliary Contacts**

Cat. No.		100-G550	100-G700	100-G860	100-G1000	100-G1200
<b>Switching of AC Loads</b>						
AC-1 I <sub>th</sub>	at 40 °C	[A]	16			16
	at 60 °C	[A]	12			12
AC-15 at rated voltage	120V	[A]	6			6
	230V	[A]	3			3
	240V	[A]	3			3
	400V	[A]	2			2
	415V	[A]	2			2
	500V	[A]	1.5			1.5
	690V	[A]	1			1
<b>Switching of DC Loads</b>						
DC-13 control of electromagnets	2V DC	[A]	6			6
	48V DC	[A]	3			3
	110V DC	[A]	1			1
	220V DC	[A]	0.5			0.5
<b>Back-up Fuse Short-circuit protection without contact welding per IEC60947-5</b>						
Fuse gG		[A]	10			16

**General**

Cat. No.		100-G550	100-G700	100-G860	100-G1000	100-G1200
<b>Rated Isolation Voltage U<sub>i</sub></b>						
IEC, AS, BS, SEV, VDE, 0660	[V]	1,000			690	
UL, CSA	[V]	600			600	
<b>Rated Impulse Voltage Withstand U<sub>imp</sub></b>						
1minuteperIEC947-4	[KV]	8			2,5	
<b>Rated Voltage-Main Control U<sub>e</sub></b>						
AC, 50/60Hz	[V]	230, 240, 400, 415, 460, 500, 575, 690V			230, 240, 400, 415, 460, 500, 575, 690V	
DC		24, 48, 110, 220, 440V				
Operating Frequency for AC Loads, 50/60 Hz	[Hz]	180/hr. for 0.25 s start time-42/hr. for 1s start time				
Insulation Class of the Magnetic Coil		Class B per VDE 0660, table 22				
Rated frequency of the Coil		AC 50/60 Hz, DC				
<b>Ambient Temperature</b>						
Storage		-40 °C...+ 80 °C				
Operation at rated current		-25 °C...70 °C				
Climatic Withstand		Damp alternating conditions cyclical, per DIN 50016 and 40046, part 38, IEC 60068				
Altitude		2000 m above sea level, per IEC60947-1				
Type of Protection		IP00 IEC 60529/DIN 40050				

**Standards Compliance and Certifications**

Standards Compliance	Certifications
EN/IEC 60947-4-1	CE Marked
IEC 60947 Type "1" Coordination	cULus Listed (File No. E 3125, Guide NLDX, NLDX7)
CSA C22.2 No. 14	
UL 508	



# Life-Load Curves

## 100-G550...100-G1200

Figure 35 - AC-3 Switching of Running Three-phase Motors,  $U_e = 380...460V$  AC; AC-1 Non or Slightly Inductive Loads, Resistance Furnaces

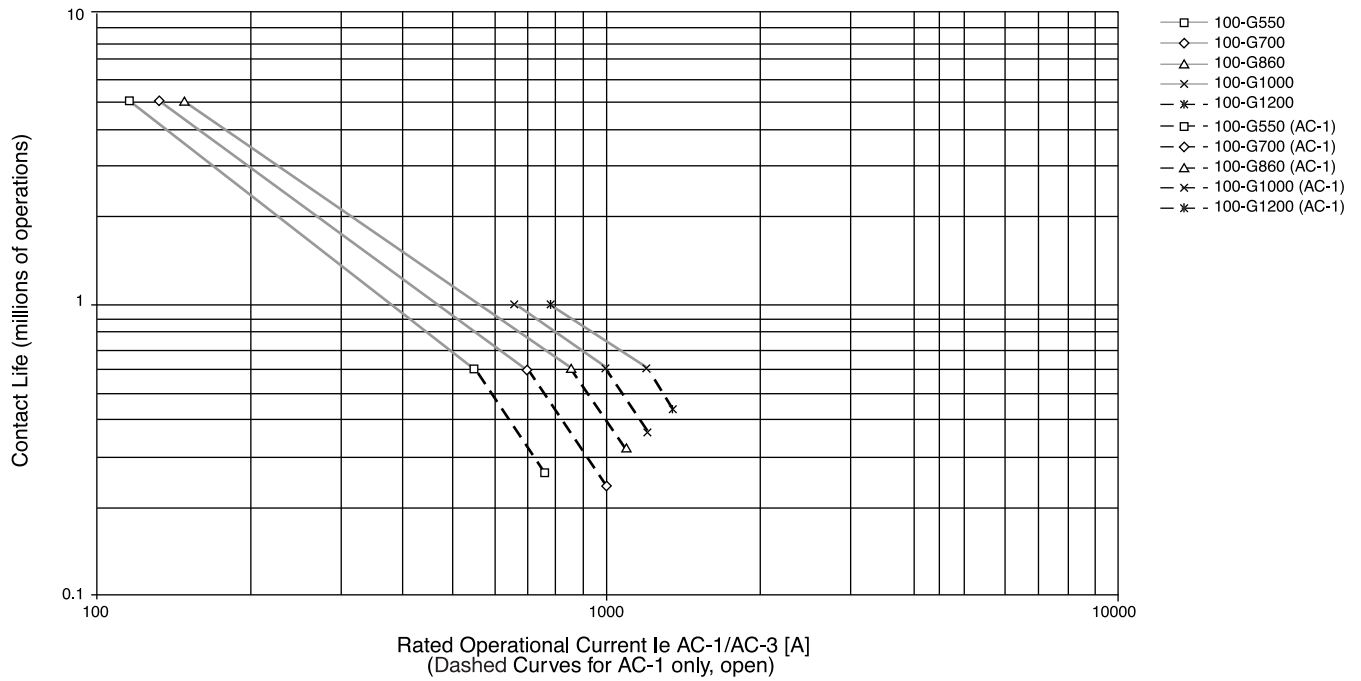

Figure 36 - AC-4 Jogging of Squirrel-cage Motors,  $U_e = 380...460V AC$

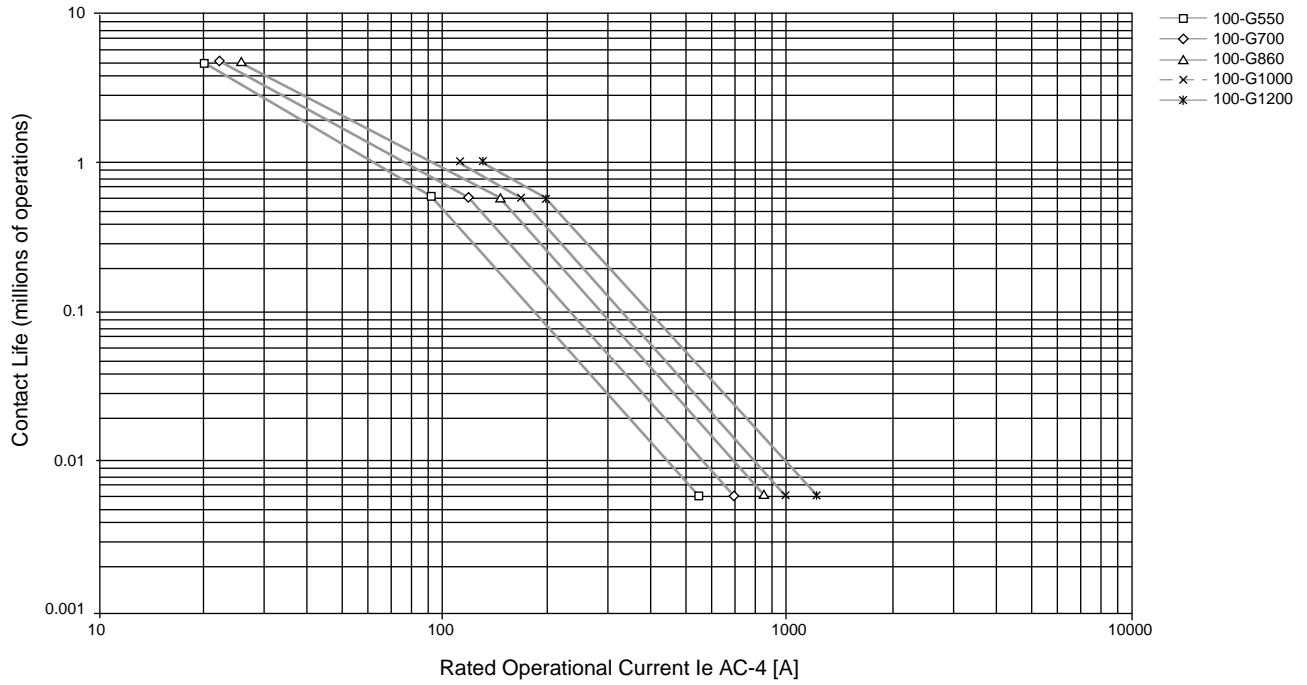
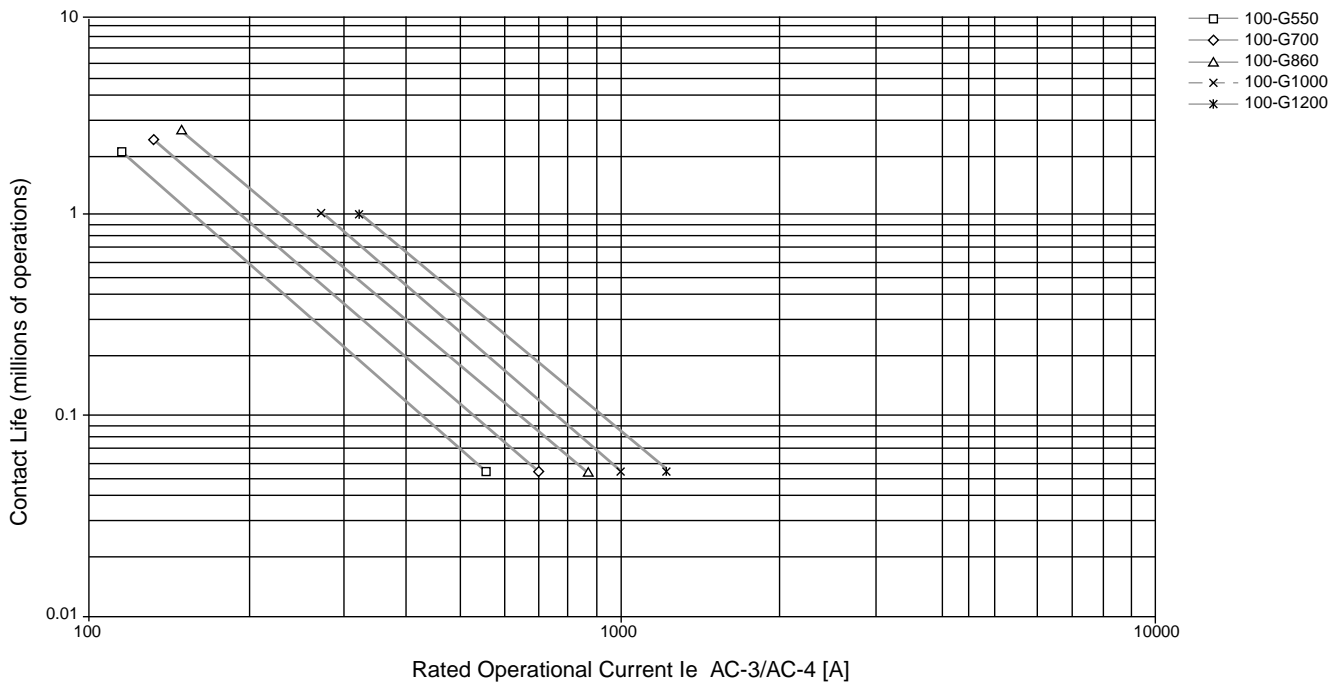

Figure 37 - AC-3 90% Switching of Running Motors,  $U_e = 380...460V AC$ ; AC-4 10% Jogging



# Permissible Switching Rate

## 100-G550...100-G1200

Figure 38 - Switching of Running Squirrel-cage Motors AC-3,  $U_e = 380...460V$  AC; Starting Time  $t_s = 0.25$  s, Relative Running Time 40%

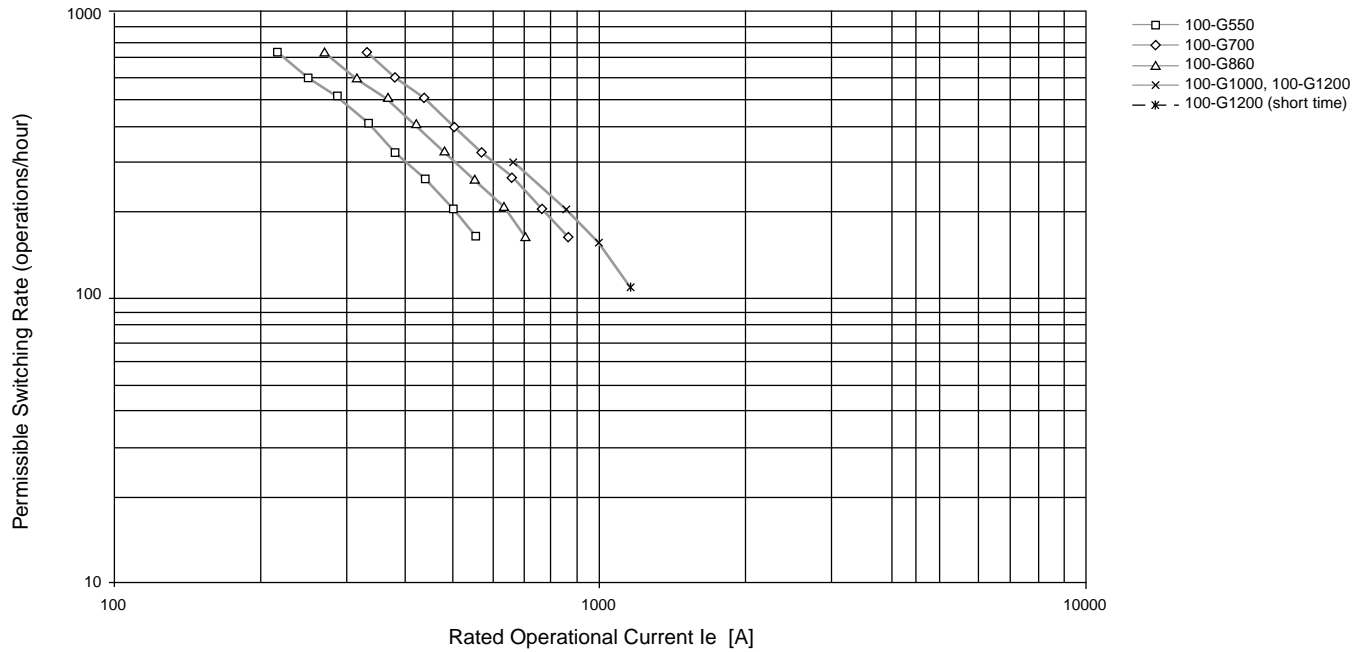

Figure 39 - Switching of Running Squirrel-cage Motors AC-3,  $U_e = 380...460V$  AC; Starting Time  $t_s = 1$  s, Relative Running Time 40%

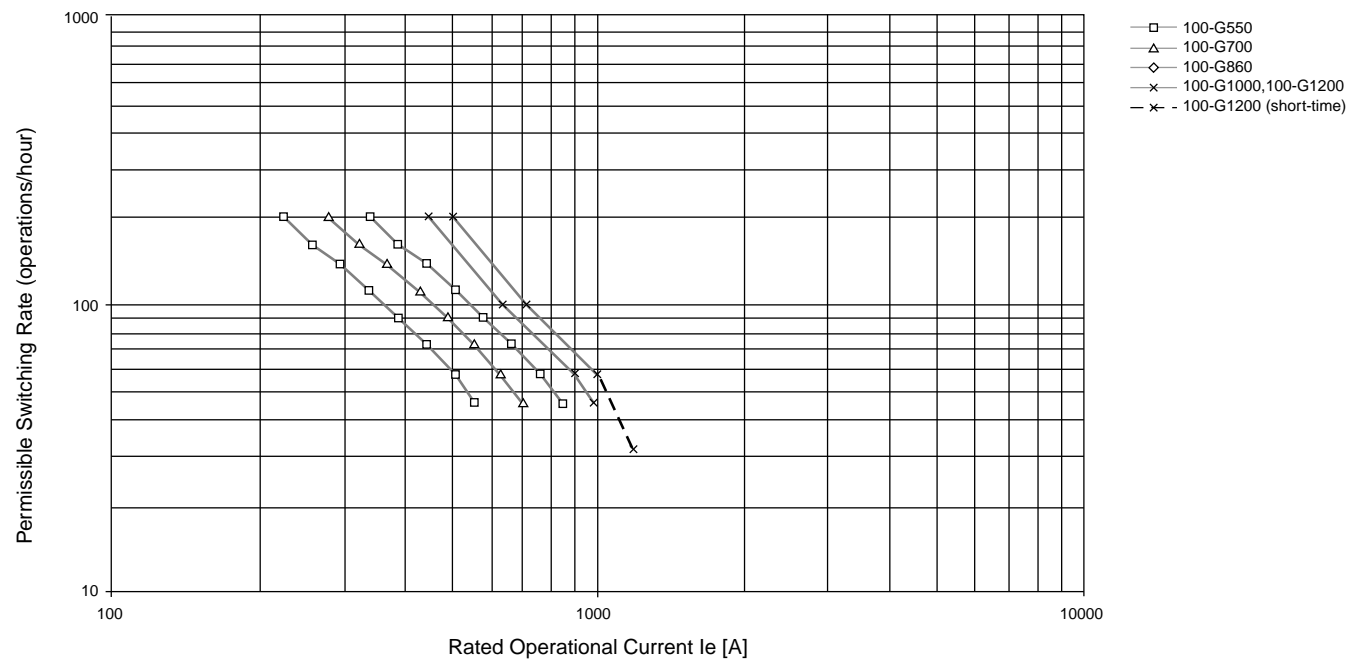
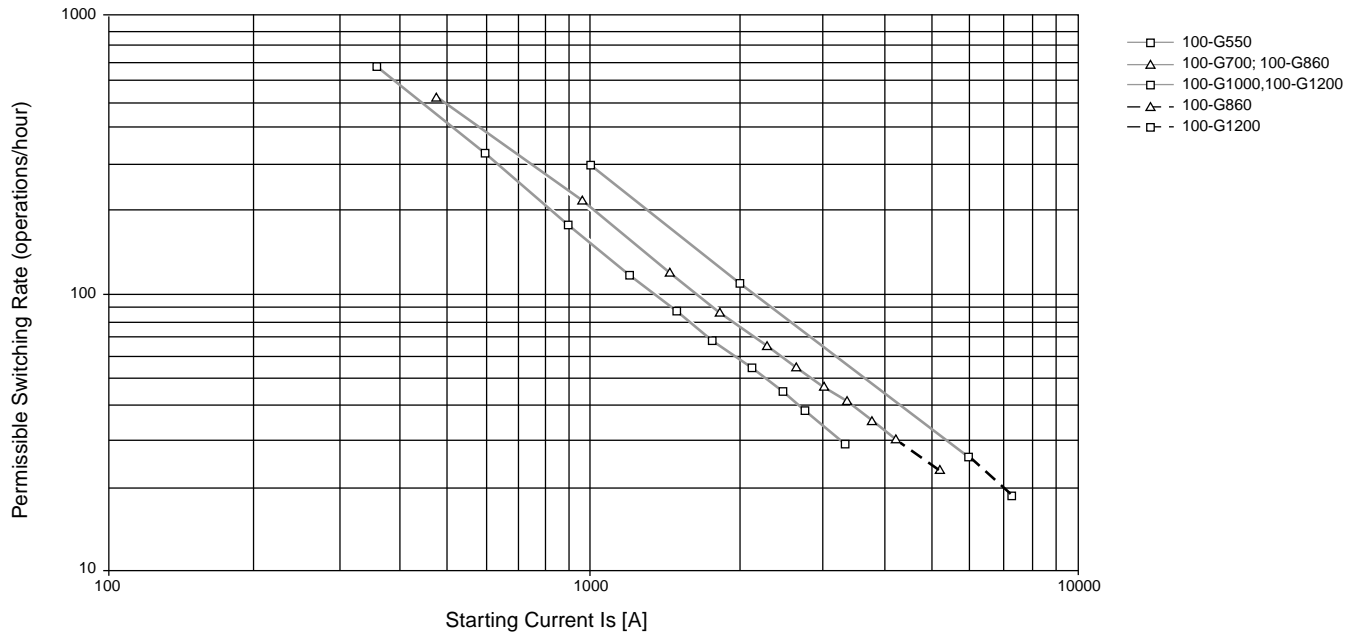

Figure 40 - Switching of Starting Motors (AC-2, and AC4)  $U_z = 380...460V$  AC; Starting Time  $t_{ed} = 1$  s, ( $<t_s$ )



# Approximate Dimensions

Dimensions are shown in millimeters (inches). Dimensions are not intended for manufacturing purposes.

**Figure 41 - Bulletin 100-G Contactors and Accessories**

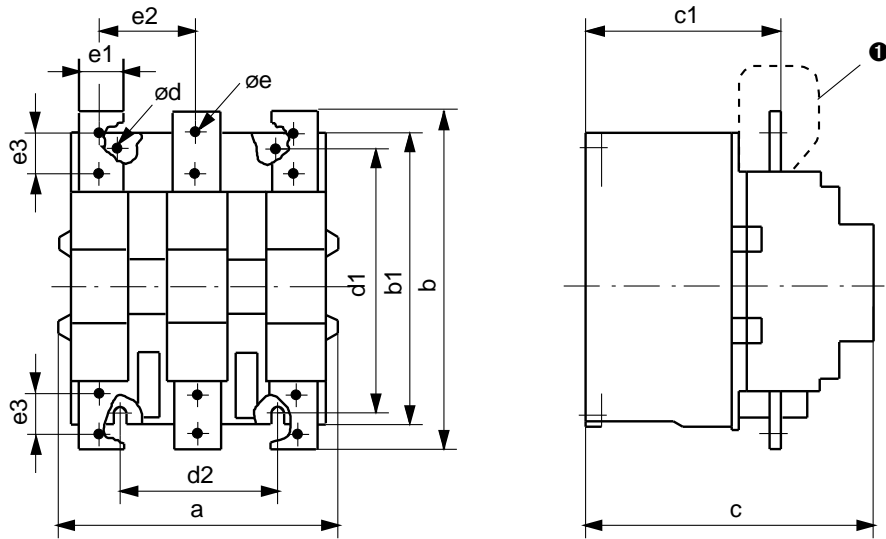

**Figure 42 - Mounting Position**

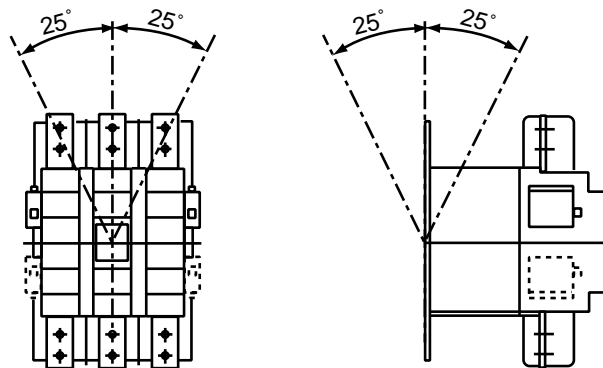

## AC and DC Contactors

Cat. No.	a	b	b1	c	c1	∅ d	d1	d2	∅ e	e1	e2	e3
100-G550	220	258	228	225	164	9	220	110	12.5	40	79	—
100-G700	280	307	277	291	203	11	280	175	13	50	101	—
100-G860	280	361	325	291	203	11	280	175	15	50	101	—
100-G1000	334	490	434	345	231	13.5	380	120	2x13	50	100	40
100-G1200	334	490	434	345	231	13.5	380	120	2x13	60	100	40

**Contactors with Accessories**

Contactor with			mm
Auxiliary contact block			a
Mechanical Interlock	side by side	100-G550/100-G550	a+42+a
		100-G700, -860/100-G700, -860	a+32+a
		100-G1000, -1200/100-G1000, -1200	a+46+a
		100-G550/100-G700, -860	a+37+a
		100-G700, -860/100-G1000, -1200	a+73+a
	stacked vertically	100-G550/100-G550	b+56 + b
		100-G700, -860/100-G700, -860	b/2+380...480+b/2
		100-G1000, -1200/100-G1000, -1200	b+120...170+b
		100-G550/100-G700, -860	b/2+400+b/2
		100-G700, -860/100-G1000, -1200	b/2+570+b/2
4th add-on neutral switching pole		100-G550	a+74
		100-G700, -860	a+68
		100-G1000, -1200	a+76
Mechanical latch		100-G550	b+59
		100-G700	b+64
		100-G860	b+37



## Rockwell Automation Support

Use the following resources to access support information.

<b>Technical Support Center</b>	Knowledgebase Articles, How-to Videos, FAQs, Chat, User Forums, and Product Notification Updates.	<a href="http://www.rockwellautomation.com/knowledgebase">www.rockwellautomation.com/knowledgebase</a>
<b>Local Technical Support Phone Numbers</b>	Locate the phone number for your country.	<a href="http://www.rockwellautomation.com/global/support/get-support-now.page">www.rockwellautomation.com/global/support/get-support-now.page</a>
<b>Direct Dial Codes</b>	Find the Direct Dial Code for your product. Use the code to route your call directly to a technical support engineer.	<a href="http://www.rockwellautomation.com/global/support/direct-dial.page">www.rockwellautomation.com/global/support/direct-dial.page</a>
<b>Literature Library</b>	Installation Instructions, Manuals, Brochures, and Technical Data.	<a href="http://www.rockwellautomation.com/literature">www.rockwellautomation.com/literature</a>
<b>Product Compatibility and Download Center (PCDC)</b>	Get help determining how products interact, check features and capabilities, and find associated firmware.	<a href="http://www.rockwellautomation.com/global/support/pcdc.page">www.rockwellautomation.com/global/support/pcdc.page</a>

## Documentation Feedback

Your comments will help us serve your documentation needs better. If you have any suggestions on how to improve this document, complete the How Are We Doing? form at [http://literature.rockwellautomation.com/idc/groups/literature/documents/du/ra-du002\\_-en-e.pdf](http://literature.rockwellautomation.com/idc/groups/literature/documents/du/ra-du002_-en-e.pdf).

Rockwell Automation maintains current product environmental information on its website at <http://www.rockwellautomation.com/rockwellautomation/about-us/sustainability-ethics/product-environmental-compliance.page>.

Allen-Bradley, Rockwell Automation, and LISTEN. THINK. SOLVE are trademarks of Rockwell Automation, Inc.  
Trademarks not belonging to Rockwell Automation are property of their respective companies.

Rockwell Otomasyon Ticaret A.Ş., Kar Plaza İş Merkezi E Blok Kat:6 34752 İçerenköy, İstanbul, Tel: +90 (216) 5698400

**[www.rockwellautomation.com](http://www.rockwellautomation.com)**

### Power, Control and Information Solutions Headquarters

Americas: Rockwell Automation, 1201 South Second Street, Milwaukee, WI 53204-2496 USA, Tel: (1) 414.382.2000, Fax: (1) 414.382.4444  
Europe/Middle East/Africa: Rockwell Automation NV, Pegasus Park, De Kleetlaan 12a, 1831 Diegem, Belgium, Tel: (32) 2 663 0600, Fax: (32) 2 663 0640  
Asia Pacific: Rockwell Automation, Level 14, Core F, Cyberport 3, 100 Cyberport Road, Hong Kong, Tel: (852) 2887 4788, Fax: (852) 2508 1846

Publication 100-TD013G-EN-P - August 2018

Supersedes Publication 100-TD013F-EN-P - November 2017

Copyright © 2018 Rockwell Automation, Inc. All rights reserved. Printed in the U.S.A.