

**Double action controller
with analogue output
1/8 DIN - 48 x 96**



ISO 9001
Certified

X3 line

User Manual • M.I.U.X3 - 4/04.02 • Cod. J30-478-1AX3 IE



Ascon Tecnologic srl
viale Indipendenza 56, 27029 Vigevano (PV)
Tel.: +39-0381 69 871 - Fax: +39-0381 69 8730
Sito internet: www.ascontecnologic.com
Indirizzo E-Mail: sales@ascontecnologic.com

Double action controller with analogue output

1/8 DIN - 48 x 96

X3 line

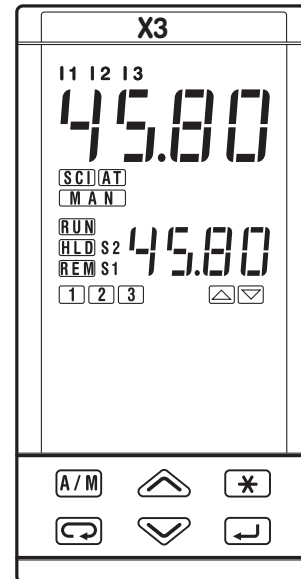



NOTES

ON ELECTRIC SAFETY AND ELECTROMAGNETIC COMPATIBILITY

Please, read carefully these instructions before proceeding with the installation of the controller.

Class II instrument, real panel mounting.

This controller has been designed with compliance to:

Regulations on electrical apparatus (appliance, systems and installations) according to the European Community directive 73/23/EEC amended by the European Community directive 93/68/EEC and the Regulations on the essential protection requirements in electrical apparatus EN61010-1 : 93 + A2:95.

Regulations on Electromagnetic Compatibility according to the European Community directive n089/336/EEC, amended by the European Community directive n° 92/31/EEC, 93/68/EEC, 98/13/EEC and the following regulations:

Regulations on RF emissions

EN61000-6-3 : 2001 residential environments

EN61000-6-4 : 2001 industrial environments

Regulation on RF immunity

EN61000-6-2 : 2001 industrial equipment and system

It is important to understand that it's responsibility of the installer to ensure the compliance of the regulations on safety requirements and EMC.

The device has no user serviceable parts and requires special equipment and specialised engineers. Therefore, a repair can be hardly carried on directly by the user. For this purpose, the manufacturer provides technical assistance and the repair service for its Customers.

Please, contact your nearest Agent for further information.

All the information and warnings about safety and electromagnetic compatibility are marked with the   sign, at the side of the note.

TABLE OF CONTENTS

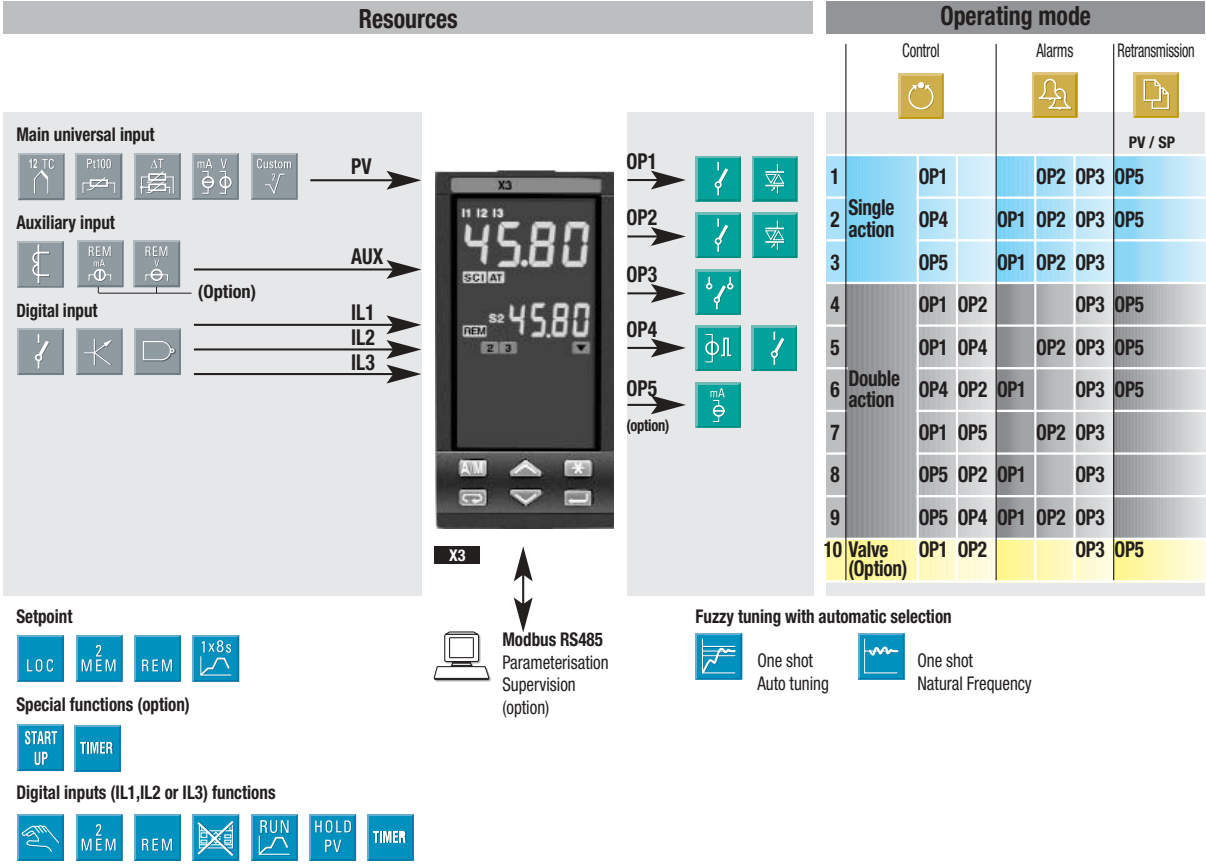

1	INSTALLATION	Page 4
2	ELECTRICAL CONNECTIONS	Page 8
3	PRODUCT CODING	Page 18
4	OPERATIONS	Page 23
5	DISPLAYS	Page 49
6	COMMANDS	Page 50
7	SETPOINT PROGRAMMER	Page 55
8	TECHNICAL SPECIFICATIONS	Page 61

1 ■ INSTALLATION

Installation must only be carried out by qualified personnel.

Before proceeding with the installation of this controller, follow the instructions illustrated in this manual and, particularly the installation precautions marked with the  symbol, related to the European Community directive on electrical protection and electromagnetic compatibility.



To prevent hands or metal touching parts that may be electrically live, **the controllers must be installed in an enclosure and/or in a cubicle.**

1.1 GENERAL DESCRIPTION

IP 20 Terminal block
EN61010 - 1 (IEC1010 - 1)

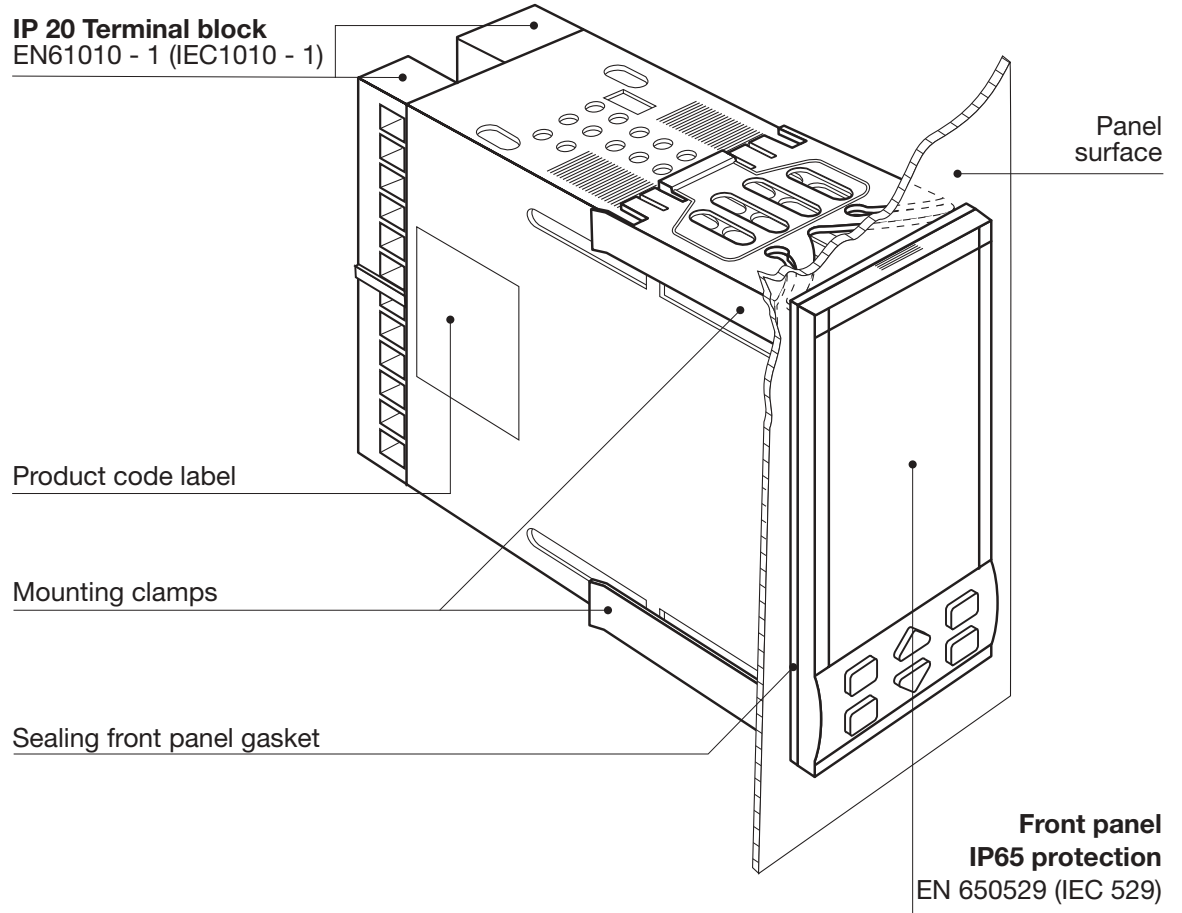

1.2 DIMENSIONAL DETAILS

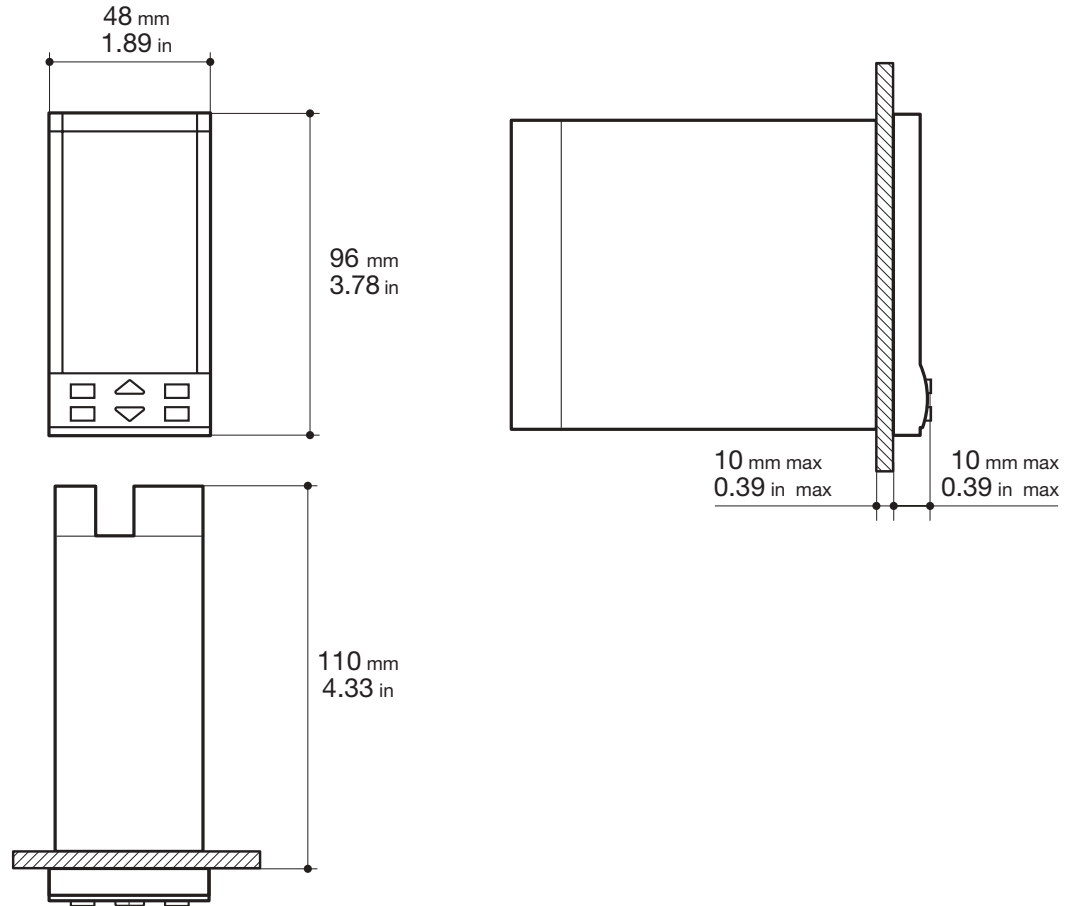

1.3 PANEL CUT-OUT

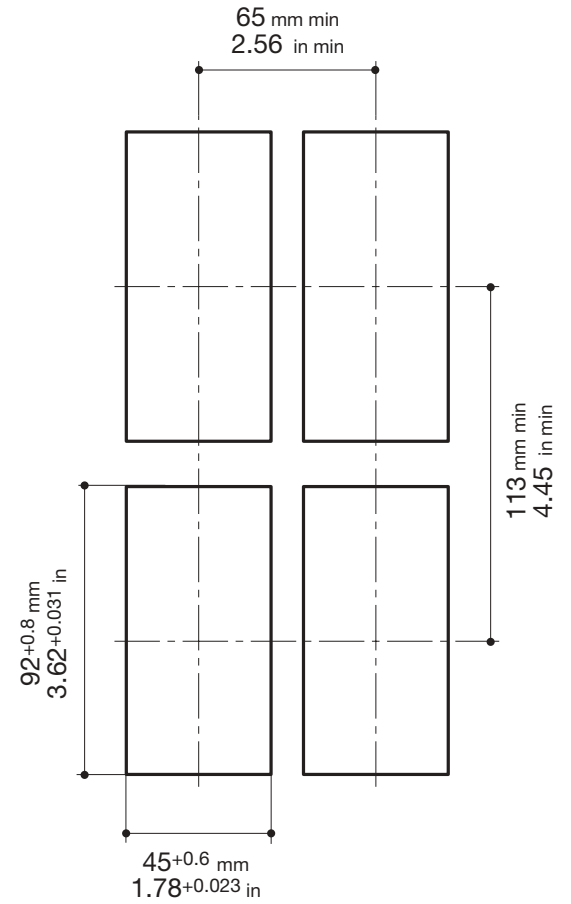

1.4 ENVIRONMENTAL CONDITIONS



Operating conditions

Altitude up to 2000 m



Temperature 0...50°C

%Rh

Relative humidity 5...95 % non-condensing

Special conditions
Suggestions

Altitude > 2000 m

Use 24Vac supply version



Temperature >50°C

Use forced air ventilation

%Rh

Humidity > 95 %

Warm up



Conducting atmosphere

Use filter

Forbidden Conditions 

Corrosive atmosphere



Explosive atmosphere

1.5 PANEL MOUNTING [1]

1.5.1 INSERT THE INSTRUMENT

- 1 Prepare panel cut-out
- 2 Check-front panel gasket position
- 3 Insert the instrument through the cut-out

UL note

[1] For Use on a Flat Surface of a Type 2 and Type 3 'raintight' Enclosure.

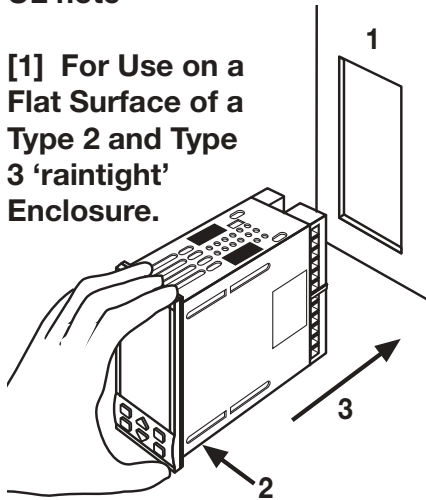

1.5.2 INSTALLATION SECURING

- 1 Fit the mounting clamps
- 2 Push the mounting clamps towards the panel surface to secure the instrument

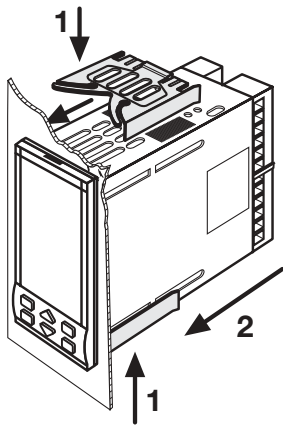

1.5.3 CLAMPS REMOVING

- 1 Insert the screwdriver in the clips of the clamps
- 2 Rotate the screwdriver

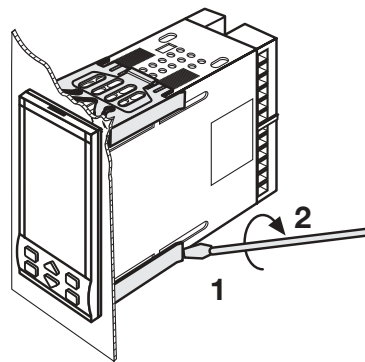

1.5.4 INSTRUMENT UNPLUGGING



- 1 Push and
- 2 Pull to remove the instrument

Electrostatic discharges can damage the instrument



Before removing the instrument the operator must discharge himself to ground

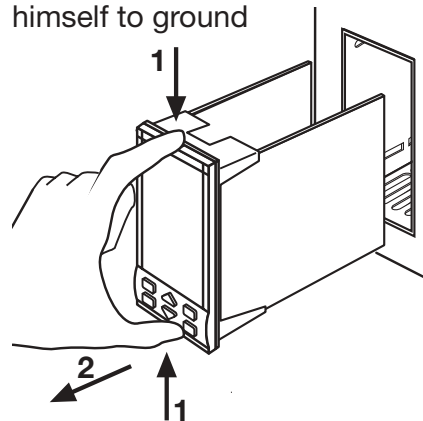

2 ELECTRICAL CONNECTIONS

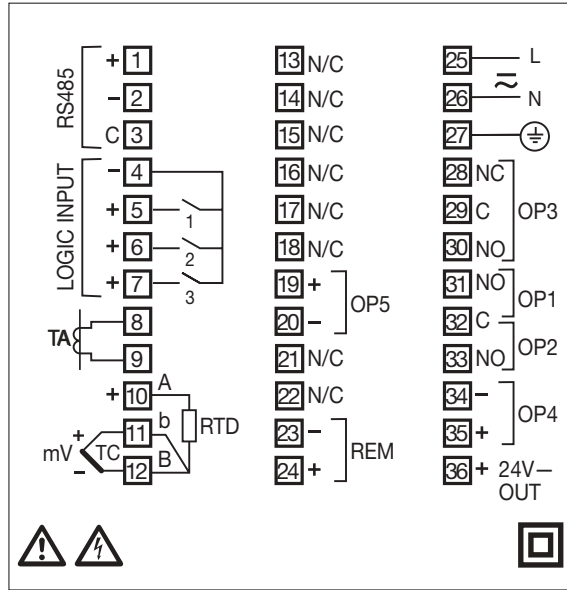

UL note
[1] Use 60/70 °C copper (Cu) conductor only.

2.1 TERMINATION UNIT [1]

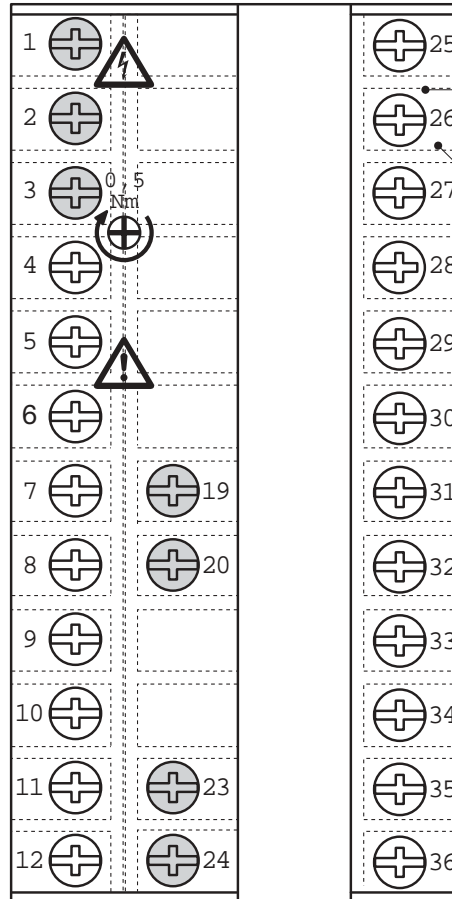

Rear terminal cover

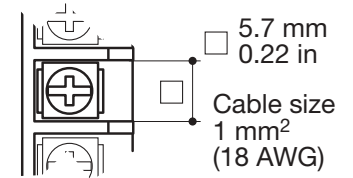

- 28 screw terminals M3
- Option terminals
- Tightening torque 0.5 Nm
- Positive screw-driver PH1
- Negative screw-driver 0,8 x 4 mm

Terminals

- Pin connector
∅ 1.4 mm 0.055 in max.
- Fork-shape AMP 165004
∅ 5.5 mm - 0.21 in
- Stripped wire
L 5.5 mm - 0.21 in

PRECAUTIONS

Despite the fact that the instrument has been designed to work in an harsh and noisy environmental (level IV of the industrial standard IEC 801-4), it is recommended to follow the following suggestions.



All the wiring must comply with the local regulations.

The supply wiring should be routed away from the power cables. Avoid to use electromagnetic contactors, power Relays and high power motors nearby.

Avoid power units nearby, especially if controlled in phase angle

Keep the low level sensor input wires away from the power lines and the output cables.

If this is not achievable, use shielded cables on the sensor input, with the shield connected to earth.

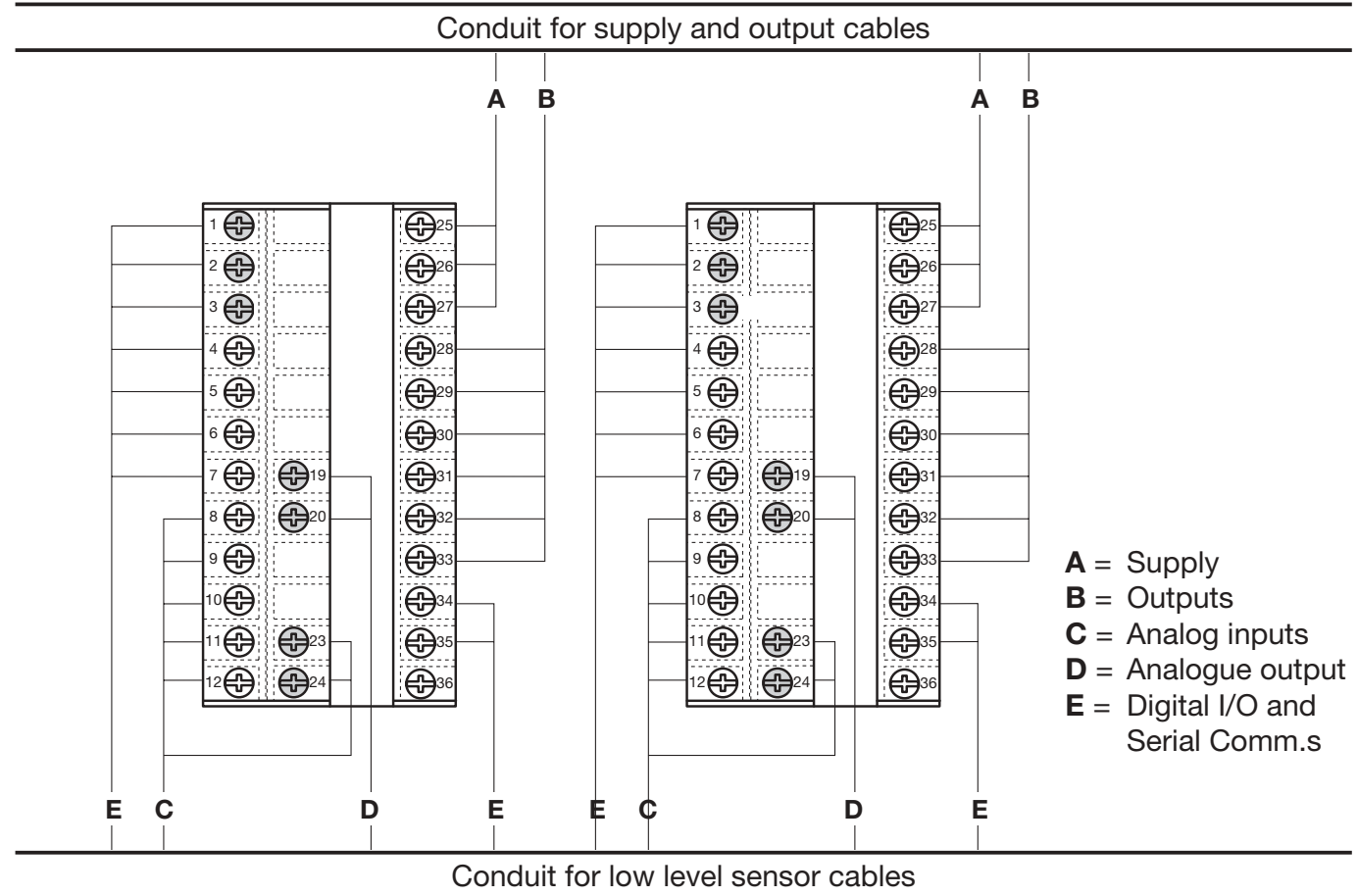
2.2 SUGGESTED WIRES ROUTING

2.3 EXAMPLE OF WIRING DIAGRAM (HEAT / COOL CONTROL)

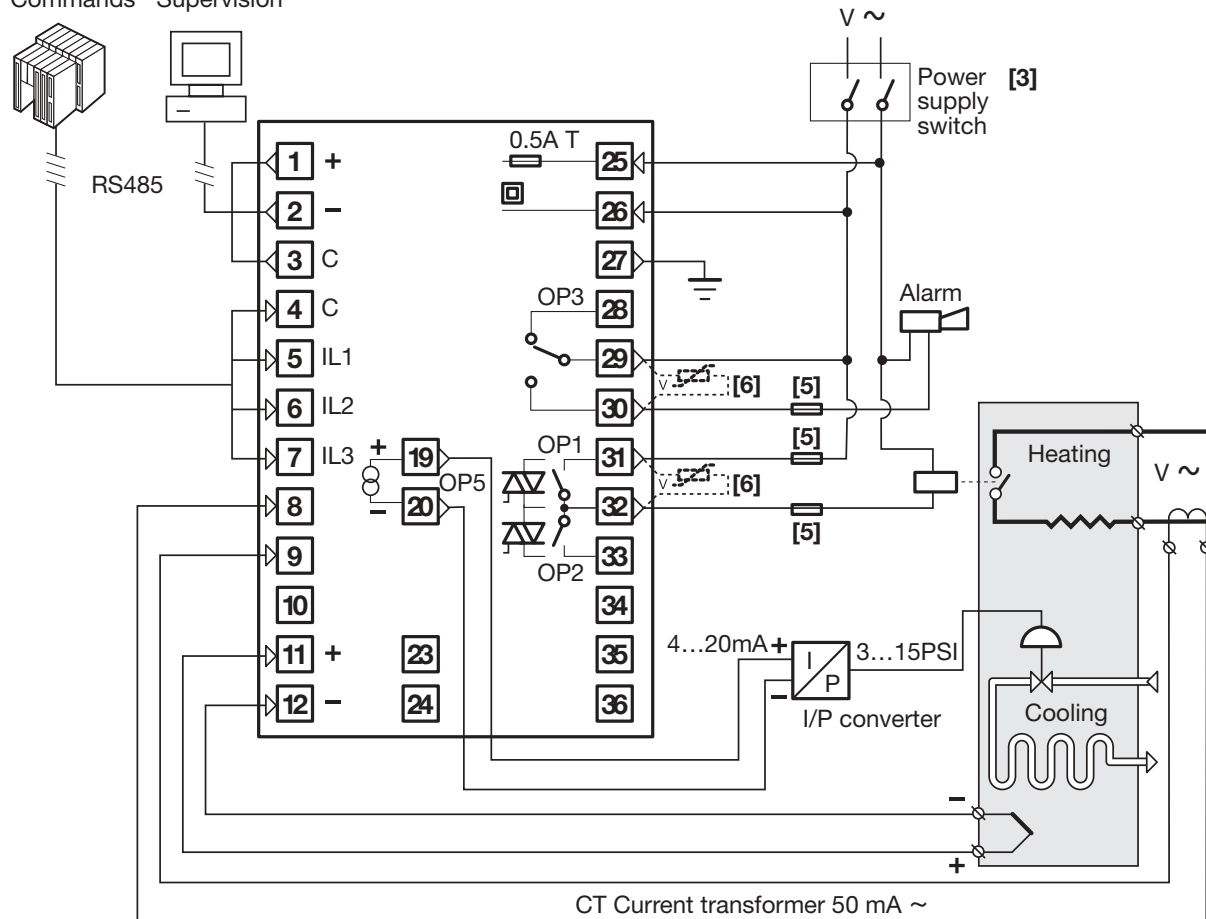

Commands Supervision

**Notes:**

- 1] Make sure that the power supply voltage is the same indicated on the instrument.
- 2] Switch on the power supply only after that all the electrical connections have been completed.
- 3] In accordance with the safety regulations, the power supply switch shall bring the identification of the relevant instrument. The power supply switch shall be easily accessible from the operator.
- 4] The instrument is PTC protected. In case of failure it is suggested to return the instrument to the manufacturer for repair.
- 5] To protect the instrument internal circuits use:
 - 2 AT fuse for Relay outputs (220 Vac);
 - 4 AT fuse for Relay outputs (110 Vac);
 - 1 AacT fuse for Triac outputs.
- 6] Relay contacts are already protected with varistors.
Only in case of 24 Vac inductive loads, use model A51-065-30D7 varistors (on request)

2.3.1 POWER SUPPLY

Switching power supply with multiple isolation and internal PTC

- **Standard version:**
nominal voltage:
100...240Vac (-15...+10%)
Frequency 50/60Hz
- **Low Voltage version:**
Nominal voltage:
24Vac (-25...+12%)
Frequency 50/60Hz
or 24Vdc (-15...+25%)

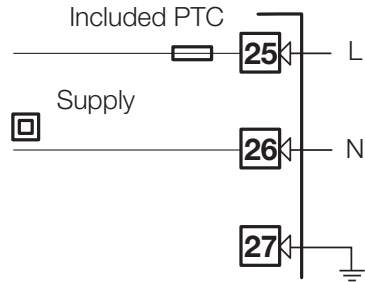

For better protection against noise, it is recommended not to connect the earth clamp provided for civilian installations.

2.3.2 PV CONTROL INPUT

A L-J-K-S-R-T-B-N-E-W thermocouple type

- Connect the wires with the polarity as shown
- Use always compensation cable of the correct type for the thermocouple used
- The shield, if present, must be connected to a proper earth.

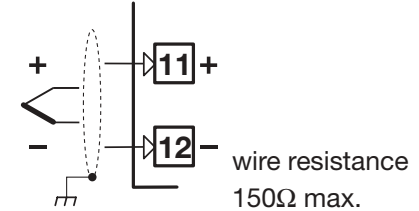

B For Pt100 resistance thermometer

- If a 3 wires system is used, use always cables of the same diameter (1mm² min.) (line 20 Ω/lead maximum resistance)
- When using a 2 wires system, use always cables of the same size (1,5mm² min.) and put a jumper between terminals 11 and 12

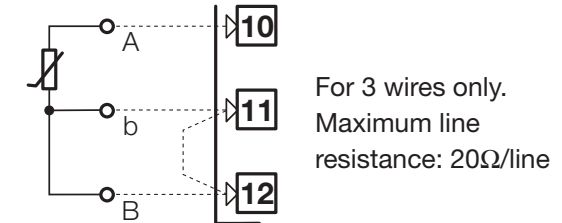

C For ΔT (2x RTD Pt100) Special

- ⚠ When the distance between the controller and the sensor is 15 m using a cable of 1.5 mm² size, produces an error on the measure of 1°C (1°F).

R1 + R2 must be <320Ω

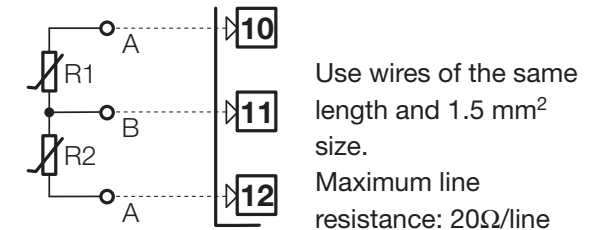

2.3.2 PV CONTROL INPUT



D For mA, mV

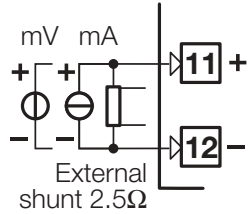

$R_j > 10M\Omega$

D1 With 2 wires transmitter

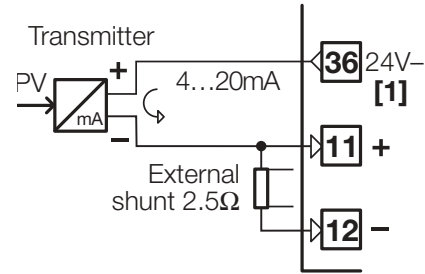

D2 With 3 wires transmitter

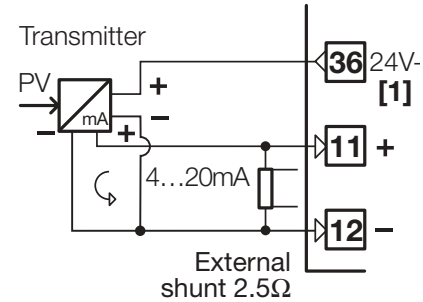

[1] Auxiliary power supply for external transmitter 24Vdc $\pm 20\%$ /30mA max. with no short circuit protection

2.3.3 AUXILIARY INPUT (OPTION)



A - From Remote Setpoint

Current 0/4...20mA
Input resistance = 30Ω

Voltage
1...5V, 0...5V, 0...10V
Input resistance = $300K\Omega$

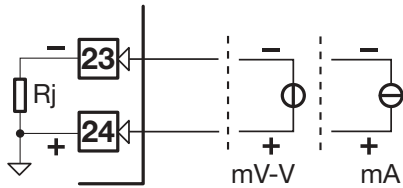

B- For current transformer CT - Not isolated

For the measure of the load current (see page 47)

- Primary coil 10A...100A
- Secondary coil 50mA default 100mA **S3** internal jumper selectable

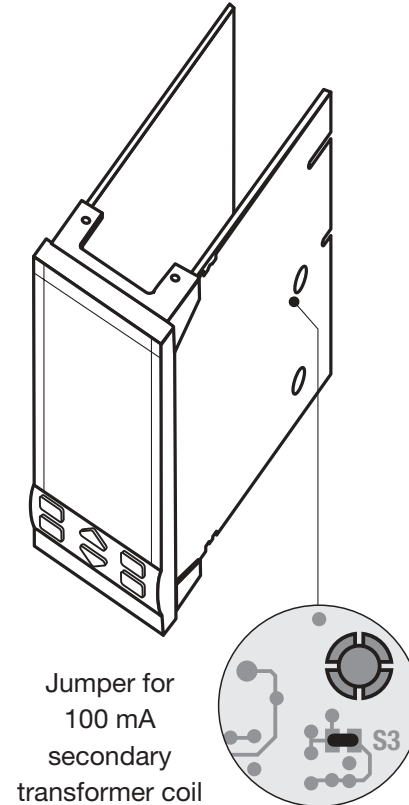
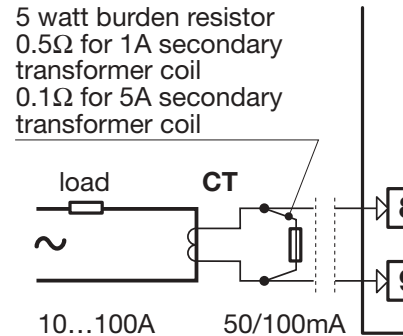

2.3.4 DIGITAL INPUT



- The input is active when the logic state is ON, corresponding to the contact closed
- The input is inactive when the logic state is OFF, corresponding to the contact open

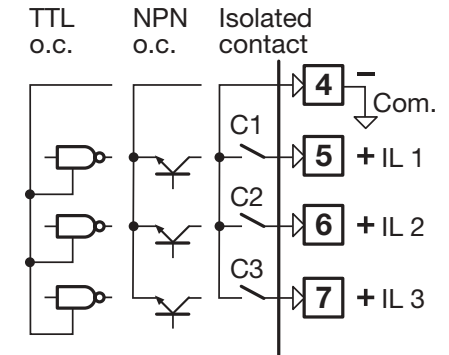

2.3.5 OP1 - OP2 - OP3 - OP4 - OP5 OUTPUTS (OPTION)

The functionality associated to each of the OP1, OP2, OP4 and OP5 output is defined during the configuration of the instrument index **N** (see page 21).

The suggested combinations are:

		Control outputs		Alarms			Retransmission
		Heat	Cool	AL1	AL2	AL3	PV / SP
A	Single action	OP1			OP2	OP3	OP5
B		OP4		OP1	OP2	OP3	OP5
C		OP5		OP1	OP2	OP3	
D	Double action	OP1	OP2			OP3	OP5
E		OP1	OP4		OP2	OP3	OP5
F		OP4	OP2	OP1		OP3	OP5
G		OP1	OP5		OP2	OP3	
H		OP5	OP2	OP1		OP3	
I		OP5	OP4	OP1	OP2	OP3	
L	Valve drive	OP1 ▲	OP2 ▼			OP3	OP5

where:

OP1 - OP2	Relay or Triac output
OP3	Relay output (for AL3 only)
OP4	SSR drive control or Relay output
OP5	Control or retransmission analogue output

2.3.5-A SINGLE ACTION RELAY (TRIAC) CONTROL OUTPUT

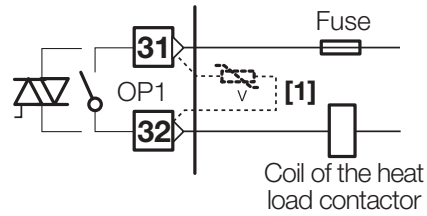

2.3.5-D DOUBLE ACTION RELAY (TRIAC)/RELAY (TRIAC) CONTROL OUTPUT

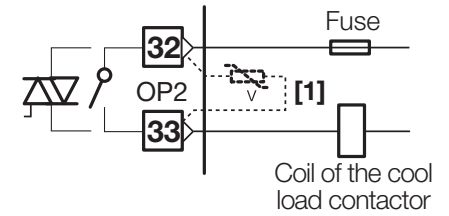
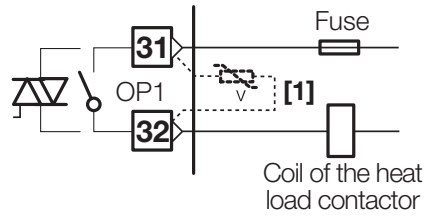

2.3.5-B SINGLE ACTION SSR DRIVE CONTROL OUTPUT

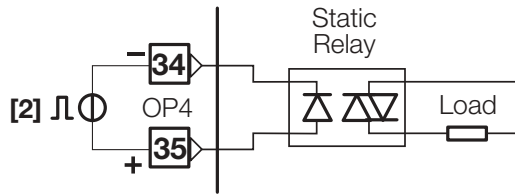

2.3.5-E DOUBLE ACTION RELAY (TRIAC)/SSR DRIVE CONTROL OUTPUT

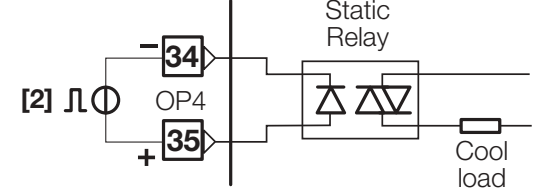
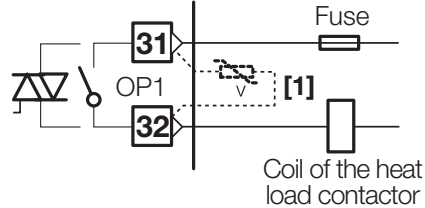

2.3.5-C SINGLE ACTION ANALOGUE OUTPUT

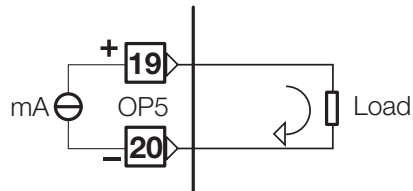

2.3.5-F DOUBLE ACTION SSR DRIVE /RELAY (TRIAC) CONTROL OUTPUT

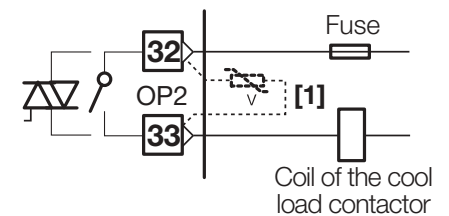
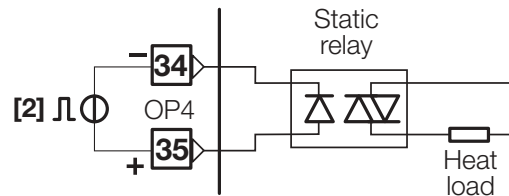

2.3.5-G HEAT / COOL CONTROL OUTPUT RELAY (TRIAC)/ANALOGUE



2.3.5-H HEAT / COOL CONTROL OUTPUT ANALOGUE/RELAY(TRIAC)



2.3.5-I HEAT / COOL CONTROL OUTPUT ANALOGUE/SSR DRIVE

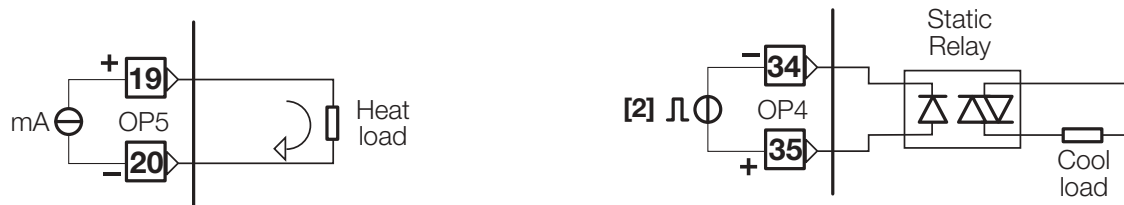

Notes:

[1] Varistor for inductive load 24Vac only.

[2] When basic product code **B** = 9, OP4 (terminals 34, 35) is a Relay output.

2.3.5-L VALVE DRIVE OUTPUT RELAY (TRIAC) / RELAY (TRIAC)

Valve drive P.I.D. **without** potentiometer 3 pole output with NO contacts (open, close, stop).

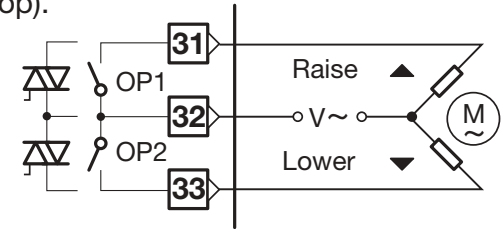

Notes:

OP1 - OP2 Relay output

- SPST Relay N.O., 2A/250Vac for resistive load, fuse 2AT at 250Vac, (4A/120Vac, fuse 4AT at 120Vac).

OP1 - OP2 Triac output

- N.O. contact for resistive load of up to 1A/250 Vac max., fuse 1Aac T.

OP4 not isolated SSR drive output

- 0...5Vdc, $\pm 20\%$, 30 mA max.

OP4 Relay output

- SPST Relay N.O., 2A/250Vac for resistive load, fuse 2AT at 250Vac (4A/120Vac, fuse 4AT at 120Vac).

OP5 isolated analogue output

- 0/4...20mA, 750 Ω / 15V max.

2.3.6 ALARM OUTPUTS



⚠ The relay/triac output OP1, OP2 and OP3, can be used as alarm outputs only if they are not used as control outputs.

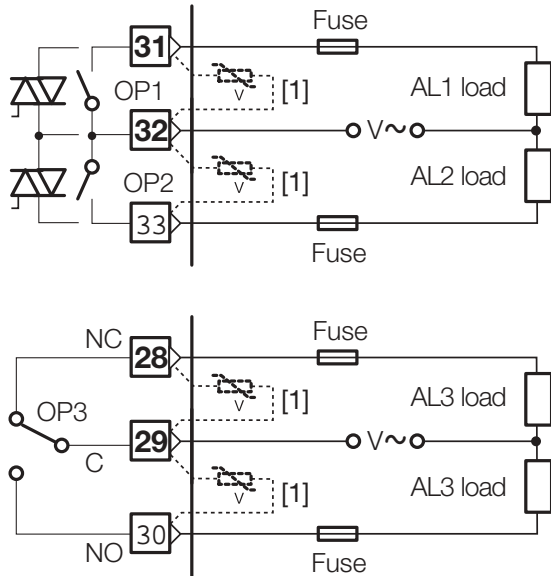

[1] Varistor for inductive load 24Vac only

2.3.7 OP5 ANALOGUE CONTROL OUTPUT (OPTION)

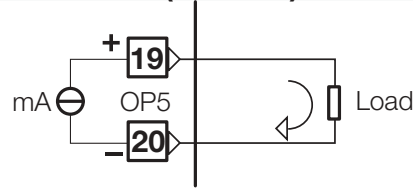

For control or PV/SP retransmission

- Galvanic isolation 500Vac/1 min.
- 0/4...20mA, (750Ω or 15Vdc max.)



Please, read: **gammadue**[®] and **delta due**[®] controller series serial communication and configuration software

2.3.8 SERIAL COMMUNICATIONS (OPTION)

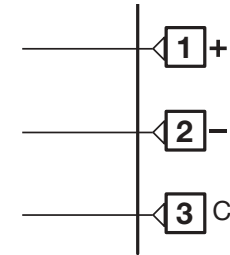

- Galvanic isolation 500Vac/1 min.
- Compliance to the EIA RS485 standard for Modbus/Jbus
- Setting dip switches

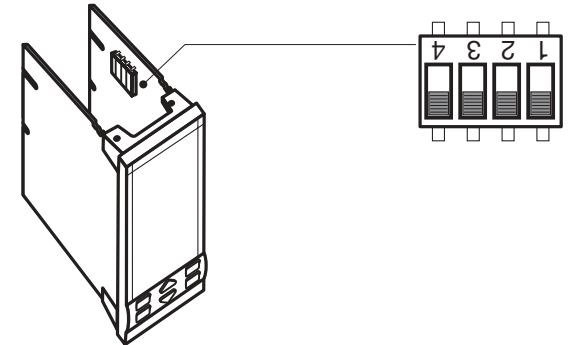

3 PRODUCT CODING

The complete code is shown on the instrument label. The informations about product coding are accessible from the front panel by mean of a particular procedure described at section 5.2 page 49.

Configuration code (software)

Basic product code (hardware)

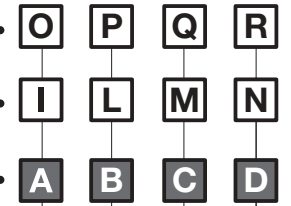

Instrument label

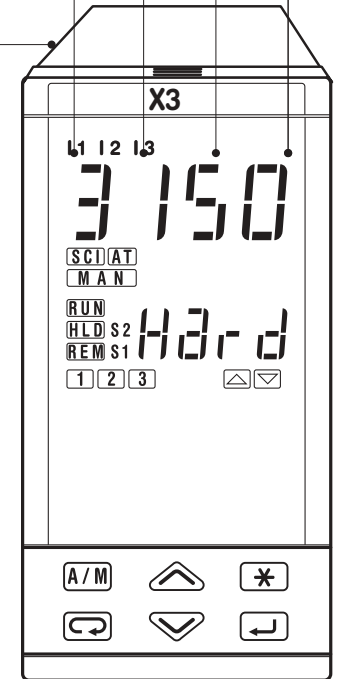
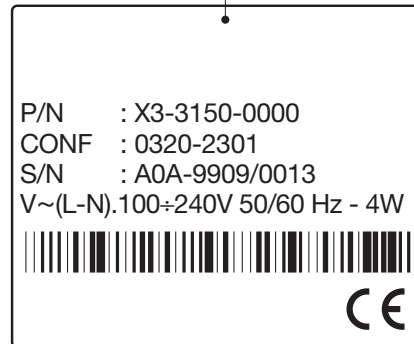

3.1 MODEL CODE

The product code indicates the specific hardware configuration of the instrument, that can be modified by specialized engineers only.

Model:	Line	Basic	Accessories	Configuration	
				1st part	2nd part
	X 3	A B C D	E F G 0	I L M N	O P Q R

Line	X 3
Power supply	A
100...240Vac (-15...+10%)	3
24Vac (-25...+12%) or 24Vdc (-15....+25%)	5
Outputs OP1 - OP2 - OP4	B
Relay - Relay - SSR Drive	1
Triac - Triac - SSR Drive	5
Relay - Relay - Relay	9
Serial Communications	C
None	0
RS485 Modbus/Jbus SLAVE	5
Options	D
None	0
Valve drive output	2
Analogue output + Remote Setpoint	5
Valve drive output + Analogue output (retr.) + Remote Setpoint	7

Setpoint Programmer - special function	E
Not fitted	0
Start-up + Timer	2
One "8 segments" program	3
User manual	F
Italian/English (std)	0
French/English	1
German/English	2
Spanish/English	3
Front panel colour	G
Dark (std)	0
Beige	1

3.2 CONFIGURATION CODING

A 4+4 index code follows the model of the controller.
The code has to be set to configure the controller
(see chapter 3.1 page 19)

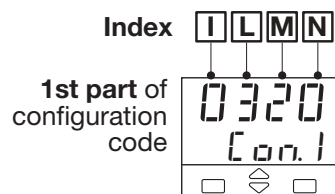

E.g. Enter the code 0320 to choose:

- T/C type J input with range 0...600°C
- Single P.I.D. control algorithm , reverse action
- Relay output

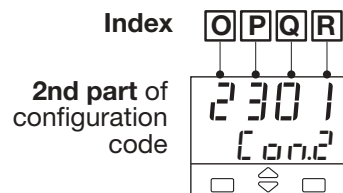

E.g. Enter the code 2301 to choose:

- AL1 absolute, active high
- AL2 absolute, active low
- AL3 Used by Timer
- Local + 2 Stored Setpoints with tracking function

Input type and range			I	L
TR Pt100 IEC751	-99.9...300.0 °C	-99.9...572.0 °F	0	0
TR Pt100 IEC751	-200...600 °C	-328...1112 °F	0	1
TC L Fe-Const DIN43710	0...600 °C	32...1112 °F	0	2
TC J Fe-Cu45% Ni IEC584	0...600 °C	32...1112 °F	0	3
TC T Cu-CuNi	-200 ...400 °C	-328...752 °F	0	4
TC K Chromel-Alumel IEC584	0...1200 °C	32...2192 °F	0	5
TC S Pt10%Rh-Pt IEC584	0...1600 °C	32...2912 °F	0	6
TC R Pt13%Rh-Pt IEC584	0...1600 °C	32...2912 °F	0	7
TC B Pt30%Rh Pt6%Rh IEC584	0...1800 °C	32...3272 °F	0	8
TC N Nicrosil-Nisil IEC584	0...1200 °C	32...2192 °F	0	9
TC E Ni10%Cr-CuNi IEC584	0...600 °C	32...1112 °F	1	0
TC NI-NiMo18%	0...1100 °C	32...2012 °F	1	1
TC W3%Re-W25%Re	0...2000 °C	32...3632 °F	1	2
TC W5%Re-W26%Re	0...2000 °C	32...3632 °F	1	3
Dc input 0...50mV linear	Engineering and units		1	4
Dc input 10...50mV linear	Engineering and units		1	5
Custom input and range [1]			1	6

[1] For instance, other thermocouples types, ΔT (with 2 PT 100), custom linearisation etc.

Control mode		M
ON-OFF reverse action		0
ON-OFF direct action		1
P.I.D. single reverse action		2
P.I.D. single direct action		3
P.I.D. double action	Linear cool output	4
	ON-OFF cool output	5
	Water cool output [2]	6
	Oil cool output [2]	7

Output configuration		N
Single action	Double action	
Relay (OP1)	Heat OP1, Cool OP2	0
SSR drive (OP4)	Heat OP1, Cool OP4	1
Analogue (OP5)	Heat OP4, Cool OP2	2
	Heat OP1, Cool OP5	3
Valve drive (OP1 and OP2)	Heat OP5, Cool OP2	4
	Heat OP4, Cool OP5	5
	Heat OP5, Cool OP4	6

[2] In consideration of the thermal characteristics of the different cooling liquids, 2 different correcting methods of the control output are available. One for water and the other for oil

$$OP \text{ water} = 100 \bullet (OP2/100)^2$$

$$OP \text{ oil} = 100 \bullet (OP2/100)^{1.5}$$

[3] Only possible whether "Output configuration" **[N]** = 0 or 1) and *H.E.F.5.* parameter is different to *FFF*, see page 31)

Alarm 1 type and function		O
Disabled		0
Sensor break/Loop break alarm (LBA)		1
Absolute	active high	2
	active low	3
Deviation	active high	4
	active low	5
Band	active out	6
	active in	7
Heater break by CT [3]	active during ON output state	8
	active during OFF output state	9

Alarm 2 type and function		P
Disabled		0
Sensor break/Loop break alarm (LBA)		1
Absolute	active high	2
	active low	3
Deviation	active high	4
	active low	5
Band	active out	6
	active in	7
Heater break by CT [3]	active during ON output state	8
	active during OFF output state	9

Alarm 3 type and function		Q
Disabled or used by Timer or related to the program		0
Sensor break/Loop break alarm (LBA)		1
Absolute	active high	2
	active low	3
Deviation	active high	4
	active low	5
Band	active out	6
	active in	7
Heater break by CT [3]	active during ON output state	8
	active during OFF output state	9

Setpoint type	R
Local only	0
Local and 2 tracking stored Setpoints	1
Local and 2 Stand-by stored Setpoints	2
Local and Remote (only if option is installed)	3
Local with trim (only with remote Setpoint)	4
Remote with trim (only if option is installed)	5
Time programmable (if option installed)	6

4 OPERATIONS

4.1.1 KEYS FUNCTIONS AND DISPLAY IN OPERATOR MODE

Digital input status LEDs (yellows)

- I 1 - IL1 active
- I 2 - IL2 active
- I 3 - IL3 active

8 Status LEDs (greens)

- SCI** Communications running
- AT** Tuning running
- MAN** Manual operating mode
- RUN** Timer/Program running
- HLD** Program Waiting
- REM** Remote Setpoint active
- S1** First stored Setpoint active
- S2** Second stored Setpoint active

Alarm status LEDs (reds)

- 1 AL1 ON
- 2 AL2 ON
- 3 AL3 ON

Auto/Man

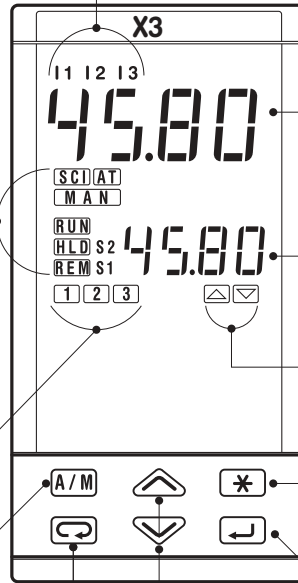

PV control input
in engineering
units



SP operating Setpoint
(Local/Remote or Stored)

Control output LEDs (red)
▲ OP1 ON - ▼ OP2 OFF

Run/stop Timer or a program

Entry key for selection and value setting confirmation



Setpoint setting

Menu access



4.1.2 KEYS FUNCTIONS AND DISPLAY IN PROGRAMMING MODE



The parameter setting procedure has a timeout. If no keys are pressed for, at least, 30 seconds, the controller switches back, automatically, to the operator mode.

After having selected the parameter or the code, press  and  to display or modify the value (see page 25)

The value is entered when the next parameter is selected, by pressing the  key.

Until the  or  are pressed or if you wait for 30 seconds the parameter value is not inserted



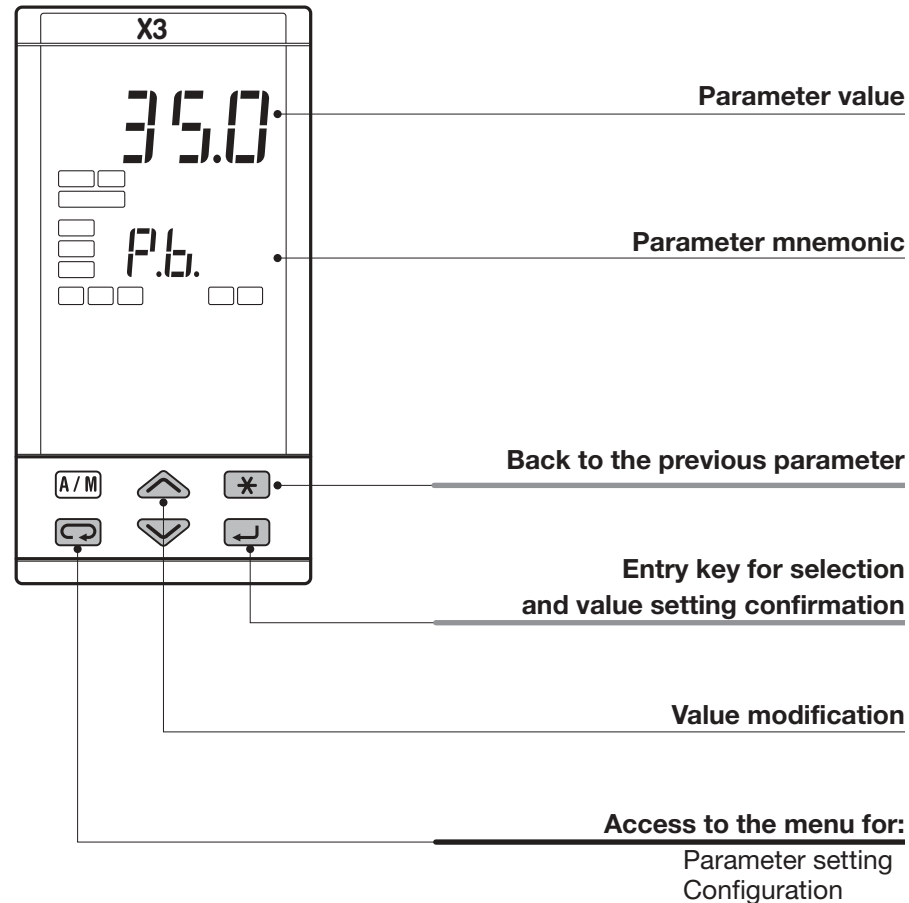

Pressing the  key, the next group of parameters is presented on the display.



4.2 PARAMETER SETTING

4.2.1 NUMERIC ENTRY

(i.e. the modification of the Setpoint value from 275.0 to 240.0)

Press  or  momentarily to change the value of 1 unit every push. Continued pressing of  or  changes the value, at rate that doubles every second. Releasing the button the rate of change decreases.

In any case the change of the value stops when it has reached the max./min limit set for the parameter.



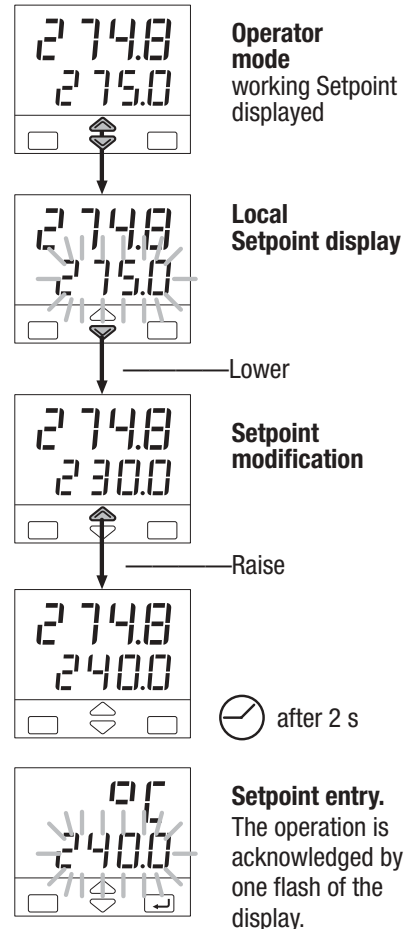

In case of Setpoint modification: press  or  once to display the local Setpoint instead of working Setpoint.

To evidence this change the display flashes once. Then the Setpoint can be modified



4.2.2 MNEMONIC CODES SETTING

(e.g. configuration see page 30)

Press the  or  to display the next or previous mnemonic for the selected parameter. Continued pressing of  or  will display further mnemonics at a rate of one mnemonic every 0.5 s. The mnemonic displayed at the time the next parameter is selected, is the one stored in the parameter.

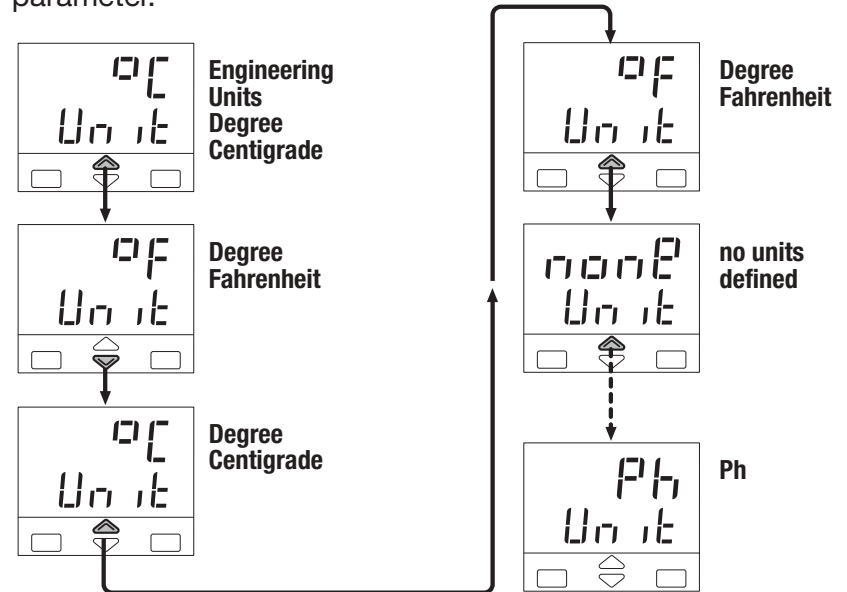

4.3 PARAMETERISATION - MAIN MENU

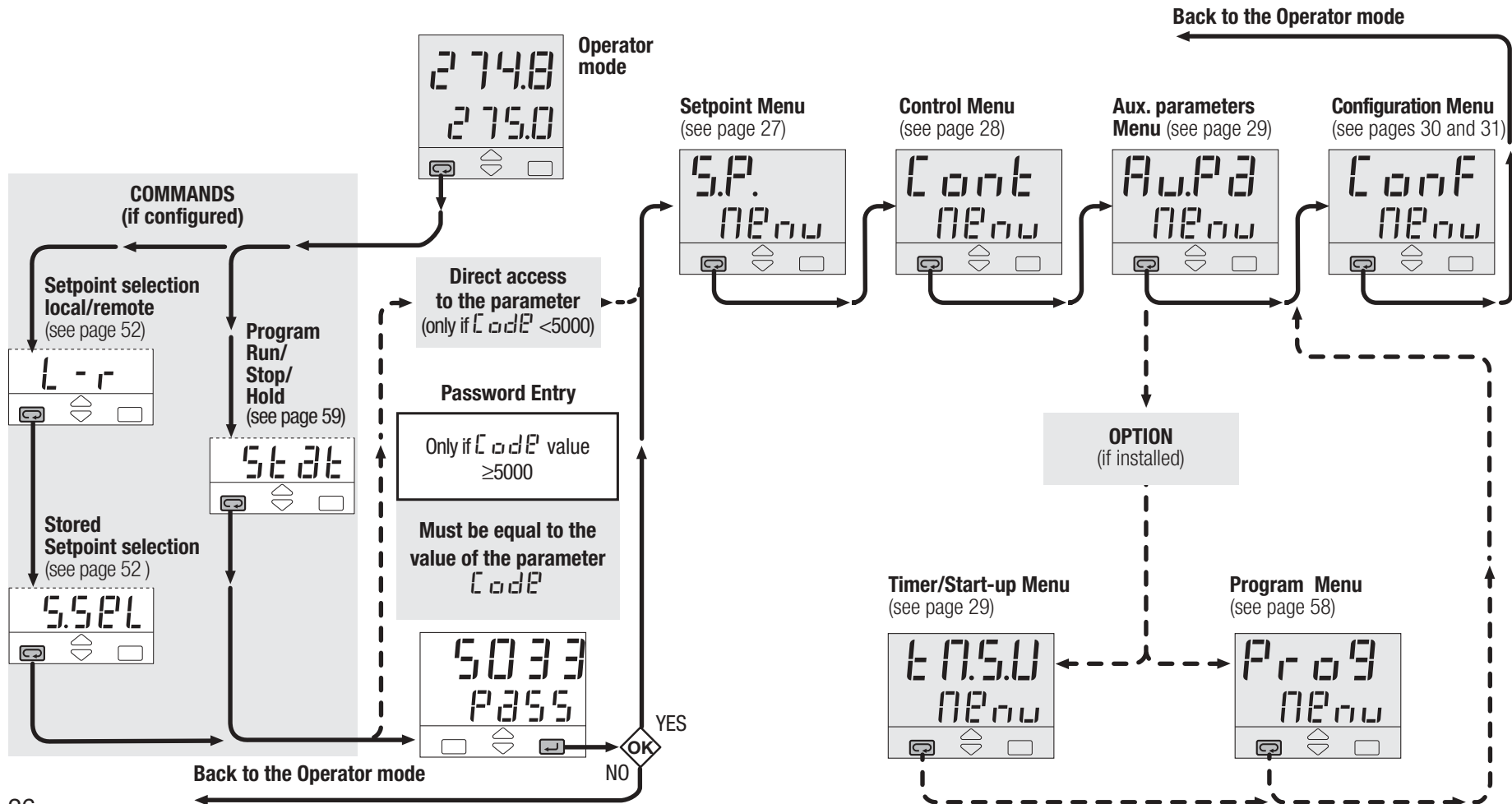

4.3.1 PARAMETERISATION - SETPOINT MENU

Setpoint menu



AL1 alarm threshold [1]
(see page 32)

0

A 15.P

AL2 alarm threshold [1]
(see page 32)

0

A 25.P

AL3 alarm threshold [1]
(see page 32)

0

A 35.P

Setpoint ramp up
OFF / 0.1...999.9
digit/min

OFF

SL. u

Setpoint ramp down
OFF / 0.1...999.9
digit/min

OFF

SL. d

L.range

S.P. L

Setpoint low limit low range...S.P. H

H.range

S.P. H

Setpoint high limit S.P. L ...High range

Note

[1] It is not presented if the controller has been configured with alarm n° 2 not active or of sensor break type. Digit O/P of the configuration code is assigned to 0 or 1.

LOCAL, PROGRAMM
configuration index **R** = 0, 6

LOCAL, + 2 STORED.
configuration index **R** = 1, 2

.....

S.P. 1

1st stored Setpoint

.....

S.P. 2

1nd stored Setpoint

REMOTE, LOCAL/REMOTE WITH TRIM
configuration index **R** = 3, 4, 5

.....

rt 10

Ratio Setpoint

.....

b 125

Remote Setpoint bias

4.3.2 PARAMETERISATION - CONTROL MENU

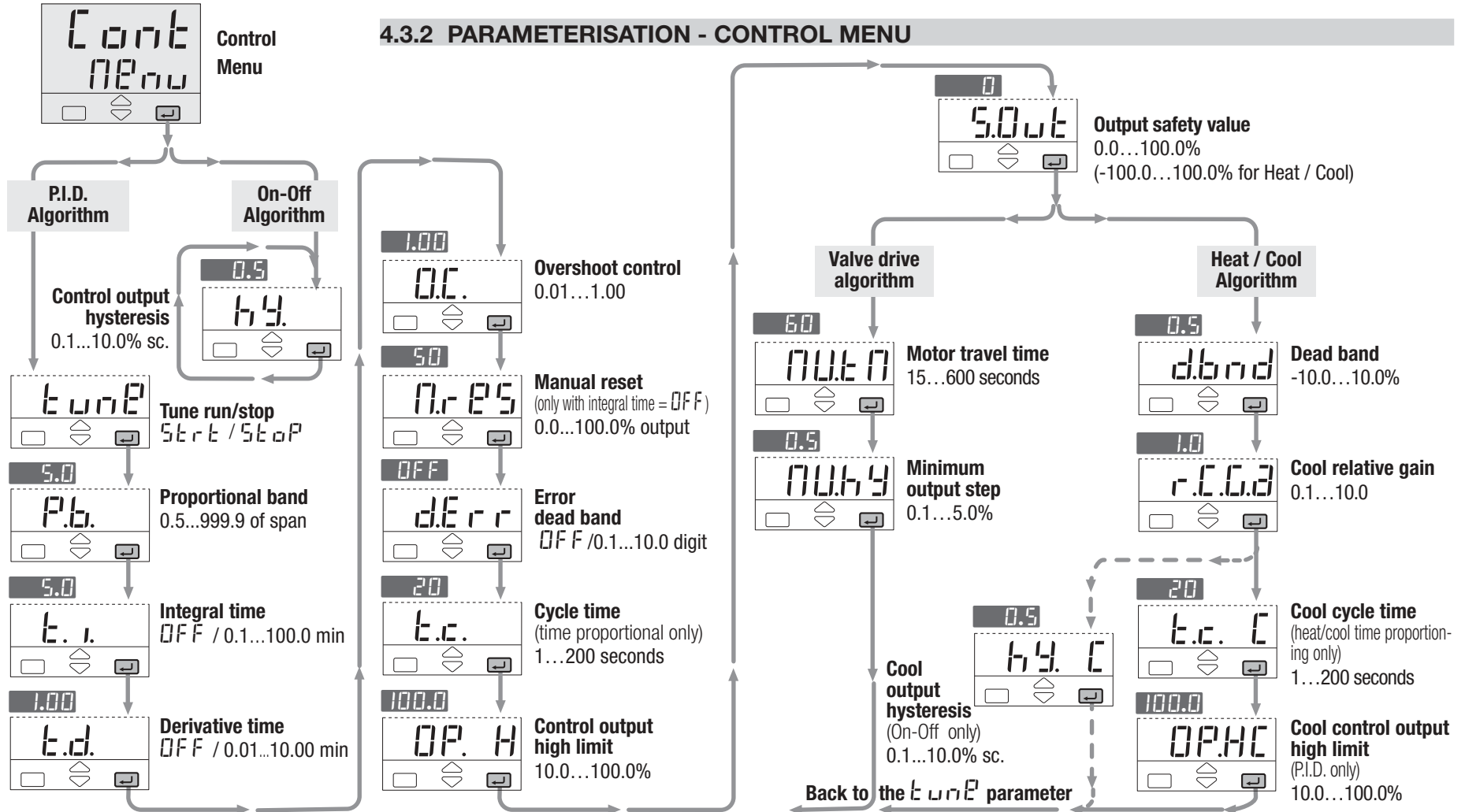

4.3.3 PARAMETERISATION - AUXILIARY PARAMETERS MENU

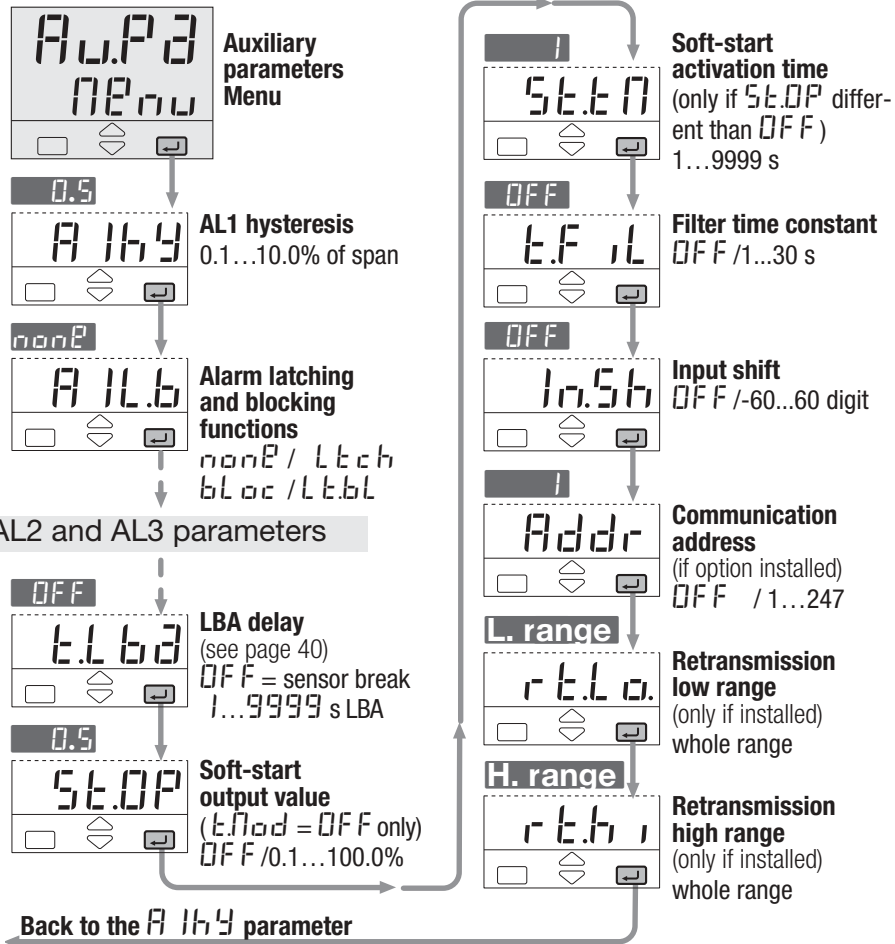

4.3.4 PARAMETERISATION - TIMER AND START-UP MENU

If options installed

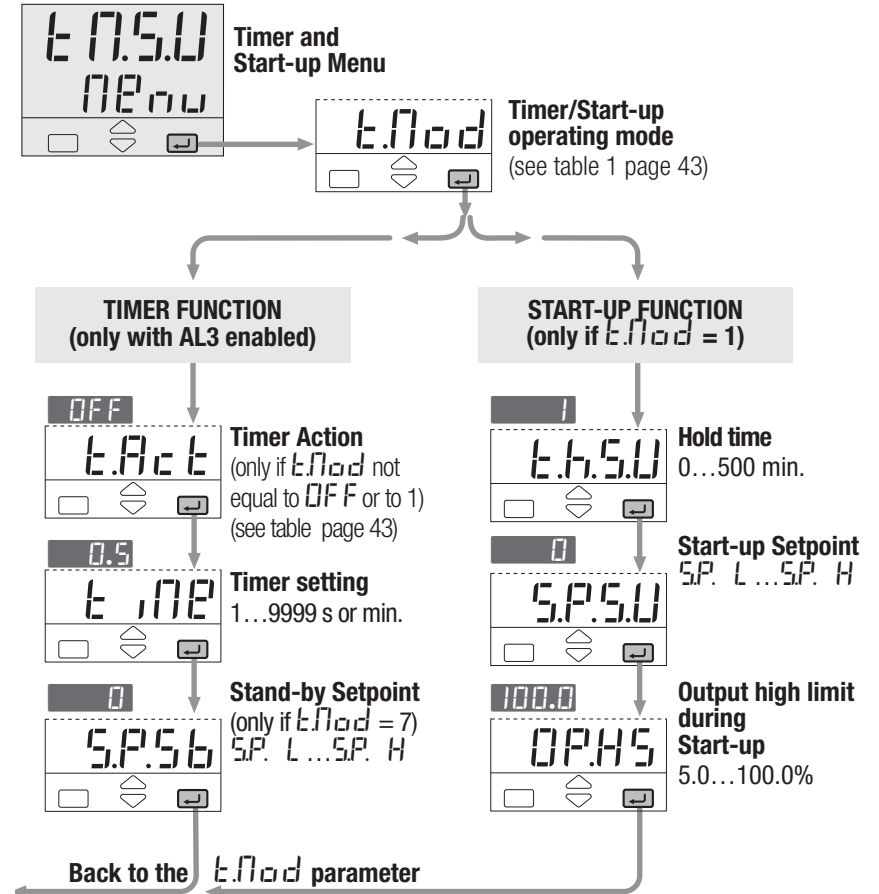

4.3.5 CONFIGURATION MENU

Enter the password before accessing to the configuration menu.

If a not configured controller is supplied, when powered up for the first time, the display shows:

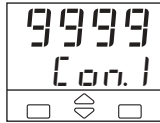

Until the configuration code is set correctly, the controller remains in stand-by with input and output deactivated.

A 4+4 index code follows the model of the controller. It has to be set to configure the controller. (see chapter 3.1 page 19)

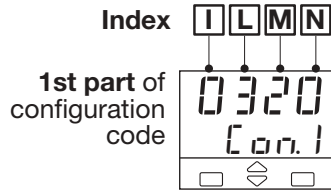

1st part of configuration code

E.g. Enter the code 0320 to choose:

- T/C type J input with range 0...600°C
- Single P.I.D. control algorithm , reverse action
- Relay output

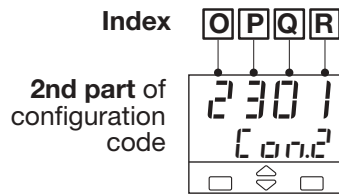

2nd part of configuration code

E.g. Enter the code 2301 to choose:

- AL1 absolute, active high
- AL2 absolute, active low
- AL3 Used by Timer
- Local + 2 Stored Setpoints with Tracking function

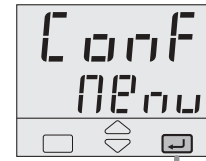

Password Entry

Only if `Code` value <5000 (33 default from factory)

Must be equal to the value of the parameter `Code`

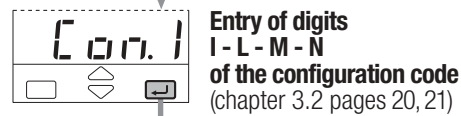
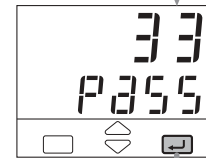

Entry of digits I-L-M-N of the configuration code (chapter 3.2 pages 20,21)

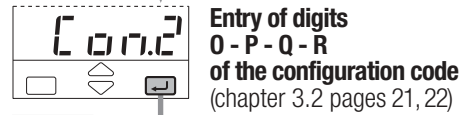

Entry of digits O-P-Q-R of the configuration code (chapter 3.2 pages 21,22)

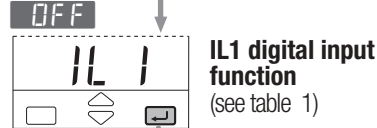

IL1 digital input function (see table 1)

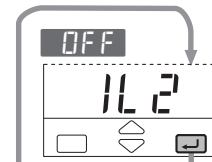

IL2 digital input function (see table 1)

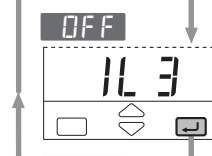

IL3 digital input function (see table 1)

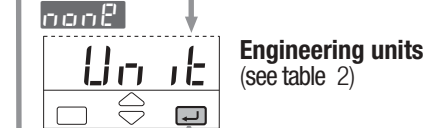

Engineering units (see table 2)

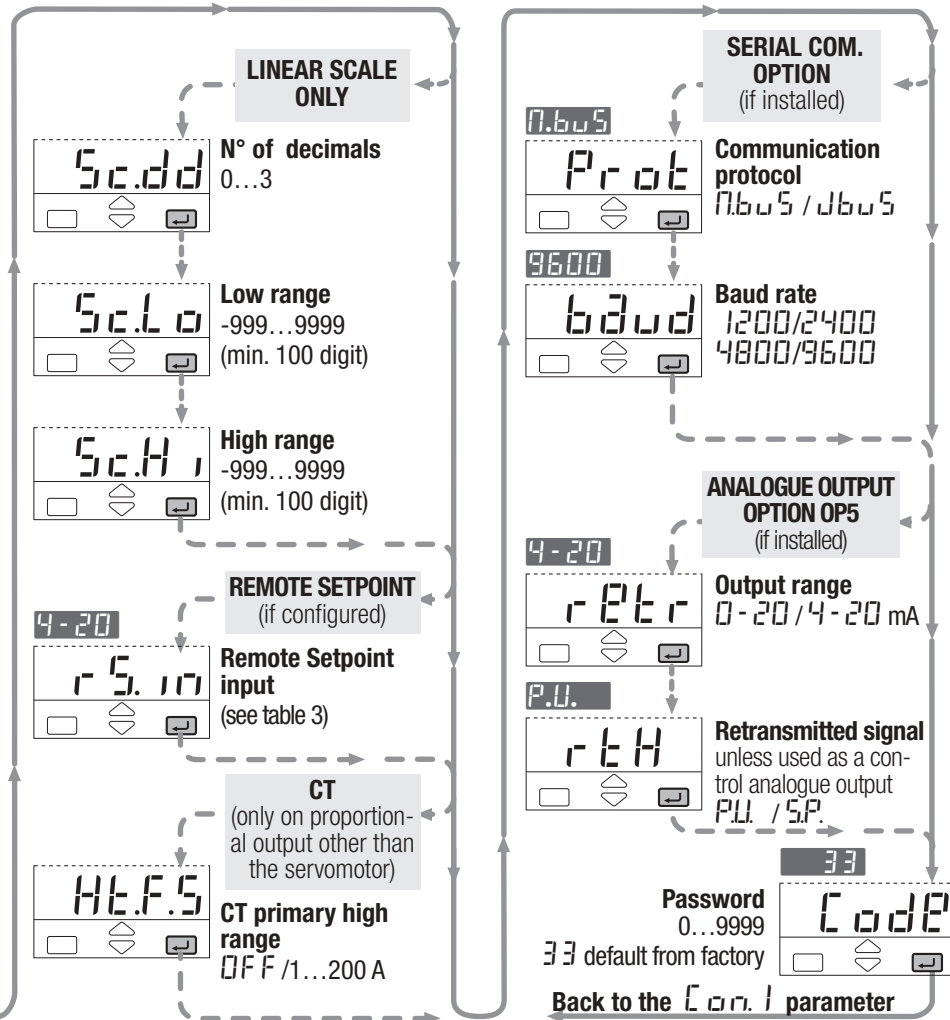

Table 1 - Digital input functions

	IL 1	IL 2	IL 3
Value	Description	Value	Description
nonE	Not used	S.P. 1	1st stored Setpoint
EE4.1	Keyboard lock	S.P. 2	2nd stored Setpoint
HPU	Measure Hold	StErT	Run Timer
ANAn	Auto/Man	r.-H.	Run/stop of a program
L-r	Local/Remote		

Table 2 - Engineering units

unit			
Value	Description	Value	Description
°C	degree centigrade	A	Ampere
°F	degree Fahrenheit	bar	Bar
nonE	none	PSI	PSI
mV	mV	Rh	Rh
V	Volt	pH	pH
mA	mA		

Table 3 - Remote Setpoint input type

r S. 1 0			
Value	Description	Value	Description
0-5	0...5 Volt	0-20	0...20 mA
1-5	1...5 Volt	4-20	4...20 mA
0-10	0...10 Volt		

4.4 PARAMETERS

For a simpler use of the controller, its parameters have been organised in groups (menu), according to their functionality area.

4.4.1 SETPOINT MENU

The OP1, OP2 or OP3 outputs, can be used for alarms if they are not used as control outputs

It is possible to configure up to 4 alarms: AL1, AL2, AL3, AL4 (see pages 21 and 22), selecting, for each of them:

- A** the type and the operating condition of the alarm
- B** the functionality of the alarm acknowledgement (latching) `[L L C H]` (see page 39)
- C** The blocking function is activated on start up (see p. 39)
- D** Loop break or sensor break (see page 40)

A ALARM TYPE AND OPERATION CONDITIONS

Absolute alarm (full scale)

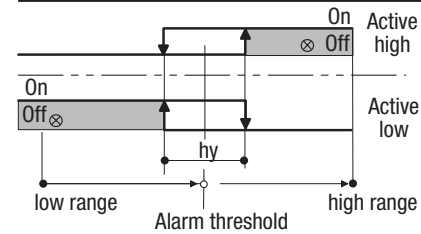

Deviation alarm

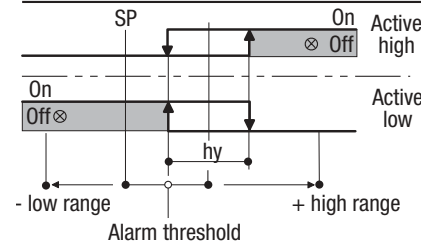

Band alarm

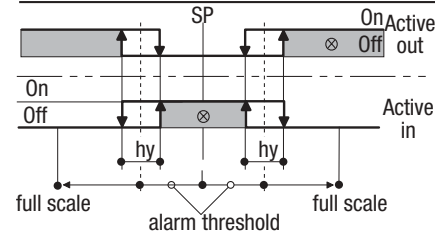

`A 15.P`

AL1 alarm threshold

`A 25.P`

AL2 alarm threshold

`A 35.P`

AL3 alarm threshold

Alarm occurrences of OP1, OP2 and OP3 outputs, respectively linked to AL1, AL2 and AL3.

The range of the alarm threshold correspond to the whole span and it is not limited by the SP Setpoint span.

When the event occurs, the display will show the red leds `[1]`, `[2]` or `[3]`, respectively on.

SL. u**Setpoint
ramp up****SL. d****Setpoint
ramp down**

This parameter specifies the maximum rate of change of the Setpoint in digit/min.

When the parameter is OFF, this function is disabled and the new Setpoint is reached immediately after being entered.

Otherwise, the Setpoint value is reached according to the configured rate of change.

The new Setpoint value is called "Target Setpoint". It can be displayed by means the parameter

ES.P.

(see procedure at page 49).

When Remote Setpoint is configured, we suggest to disable **SL. u** and **SL. d** parameters **OFF**.

Example

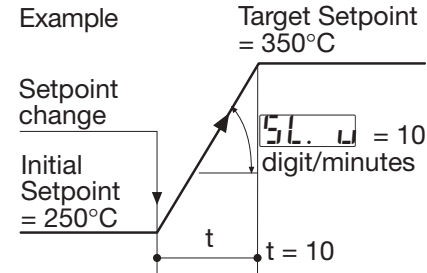
**S.P. L****Setpoint
low limit****S.P. H****Setpoint
high limit**

Low / high limit of the Setpoint value.

S.P. 1**1st stored
Setpoint****S.P. 2****2nd stored
Setpoint**

Values of the two Setpoints, that are activated by mean of digital inputs, communication parameters, and keypad. The Setpoint active is indicated by the **S1** or **S2** green led.

If index **R = 1** (tracking), the previous Local Setpoint value will be lost, when the stored Setpoint is selected.

If index **R = 2** (Stand-by), the Local Setpoint value will not

be lost, when the Stand-by Setpoint is selected. It will operate again when back to Local.

See stored Setpoint selection procedure at page 52

4.4.1 SETPOINT MENU

rt 10

Remote Setpoint Ratio

Ratio is the coeff. which defines the remote Setpoint span with respect to the input span.

b 125

Remote Setpoint

Bias defines the starting point of analogue Remote Setpoint in eng. units corresponding to the low limit (current or voltage) of the remote signal.

Remote Setpoint Bias and Ratio

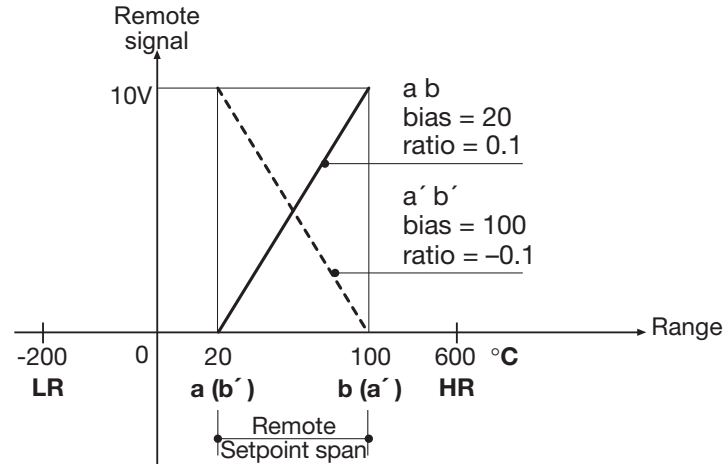

- PV = process variable
- LR = PV low limit
- HR = PV high limit
- SR = Remote Setpoint
- a (a') = SR starting point
- b (b') = SR ending point

If SR starting point is **lower** than the ending point, both expressed in engineering units:

$b \text{ 125} = \text{starting point} = a$

$$rt \ 10 = \frac{b - a}{HR - LR}$$

Example:

$b \text{ 125} = 20$

$rt \ 10 =$

$$\frac{100 - 20}{600 - (-200)} = \frac{80}{800} = 0.1$$

If SR starting point is **higher** then the ending point, both expressed in engineering units

$b_{i\dot{5}} = \text{starting point} = a'$

$$r_{t_{10}} = \frac{b' - a'}{HR - LR}$$

Example:

$b_{i\dot{5}} = 100$

$r_{t_{10}} =$

$$\frac{20 - 100}{600 - (-200)} = \frac{-80}{800} = -0.1$$

Working Setpoint (SP) as combination of Local Setpoint (SL) and remote signal

Setpoint type *L o c k*
(configuration index $\boxed{R} = 4$)
 $SP = SL + (r_{t_{10}} \cdot REM) + b_{i\dot{5}}$

Setpoint type *r e m o t e*
(configuration index $\boxed{R} = 5$)
 $SP = REM + (r_{t_{10}} \cdot SL) + b_{i\dot{5}}$

SIGN = Remote signal percentage

SPAN = HR-LR

$$REM = \frac{SIGN \cdot SPAN}{100}$$

Examples:

Local Setpoint (SL) with an external Trim with multiplying coeff. of 1/10:

Setpoint type = *L o c k*

$r_{t_{10}} = 0.1$

$b_{i\dot{5}} = 0$

Remote Setpoint (SR) with an internal Trim with multiplying coeff. of 1/5:

Setpoint type = *r e m o t e*

$r_{t_{10}} = 0.2$

$b_{i\dot{5}} = 0$

Remote Setpoint range equal to the Input range:

Setpoint type = *L o c k*

$r_{t_{10}} = 1$

$b_{i\dot{5}} = LR$

$SL = 0$

4.4.2 CONTROL MENU

tune Run
Tuning

4.4.2.1 AUTOMATIC TUNE

The **Fuzzy-Tuning** determines automatically the best P.I.D. term with respect to the process behaviour.

The controller provides 2 types of “one shot” tuning algorithm, that are selected automatically according to the process condition when the operation is started.

STEP response

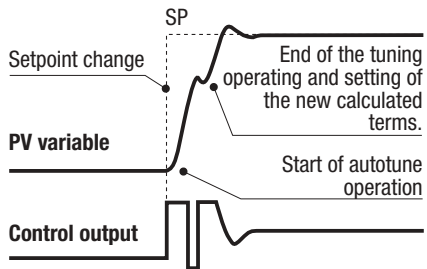

This type is selected when, at the start of the autotune operation, the PV is far from the Setpoint of more than 5% of the span. This method has the big advantage of fast calculation, with a reasonable accuracy in the term calculation.

Natural frequency

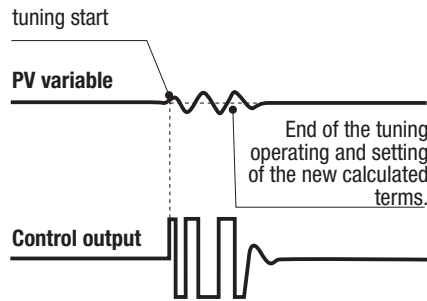

This type is selected when the PV is close to the SP Setpoint. This method has the advantage of a better accuracy in the term calculation with a reasonable speed calculation.

The **Fuzzy Tuning** determines automatically the best method to use to calculate the P.I.D. term, according the process conditions.

FUZZY-TUNING START/STOP PROCEDURE

Start/stop of the Fuzzy Tuning
The Tuning operation can be started or stopped any time.

The green led **[AT]** is ON when the Fuzzy Tuning is in progress. At the end of this operation, the calculated P.I.D. terms parameter are stored and used by the control algorithm and the controller goes back to the operator mode. The green led **[AT]** becomes off.

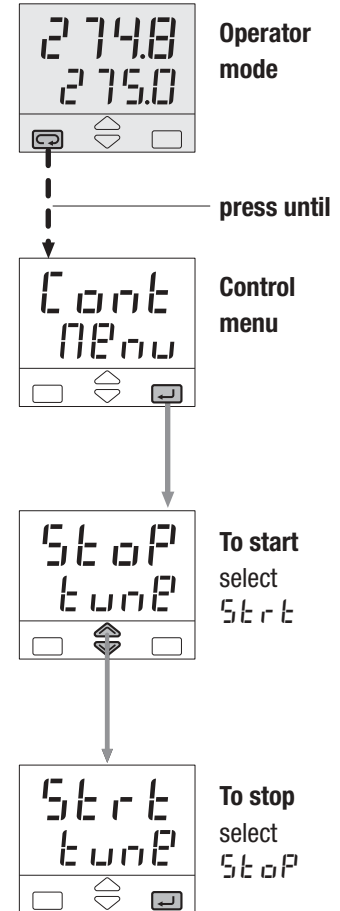

P.b. Proportional band

This parameter specifies the proportional band coefficient that multiplies the error (SP - PV)

I. Integral time

It is the integral time value, that specifies the time required by the integral term to generate an output equivalent to the proportional term. When **OFF** the integral term is not included in the control algorithm.

d. Derivative time

It is the time required by the proportional term P to repeat the output provided by the derivative term D. When **OFF** the derivative term is not included in the control algorithm.

O.C. Overshoot control

This parameter specifies the span of action of the overshoot control. Setting lower values (1.00 → 0.01) the overshoot generated by a Setpoint change is reduced. The overshoot control doesn't affect the effectiveness of the P.I.D. algorithm. Setting 1, the overshoot control is disabled.

Man. Rst Manual Reset

This specifies the control output value when PV = SP, in a PD only algorithm (lack of the integral term).

Err. DB Error Dead Band

Inside this band for (PV - SP), the control output does not change to protect the actuator (output Stand-by)

C.C. Control output cycle time**C.C.** Cool cycle time

It's the cycle time of the time proportioning control output. The P.I.D. control output is provided by the pulse width modulation of the waveform.

OP. H Control output high limit**OP.C.H** Cool output high limit

It specifies the maximum value the control output can be set. It is applied in manual mode, too.

S.O.Vt Output Safety Value

Output Value in case of input anomaly

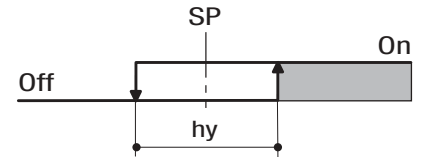
H9. Control output hysteresis**H9.** Cool output hysteresis

Control or alarm output hysteresis span, set in % of the full scale.

TRVt Travel time

It provides the time required to the motor positioner to go from the 0% position to 100%

TRVt Minimum step

It specifies the minimum allowed time of activation of the output to a motor positioner that produces a sensible effect. It is related to the deadband of the positioner

4.4.2 CONTROL MENU

4.4.2.2 HEAT / COOL CONTROL

By a sole P.I.D. control algorithm, the controller handles two different outputs, one of these performs the Heat action, the other one the Cool action.

It is possible to overlap the outputs.

The dead band parameter `dbnd` is the zone where it is possible to separate or overlap the Heat and Cool actions.

The Cool action can be adjusted using the relative cool gain parameter `r.c.g.a.`

To limit the Heat and Cool outputs the parameters `OP.H` and `OP.HC` can be used.

When there is an overlap, the displayed output `OUT` shows the algebraic sum of the Heat and Cool outputs.

A Heat /Cool actions separated

Insert positive `dbnd` value (0...10%)

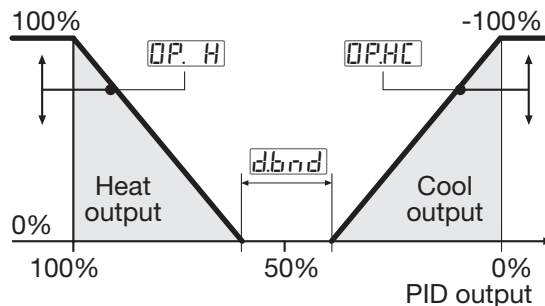

B Heat /Cool actions overlapped

Insert negative `dbnd` value (-10...0%)

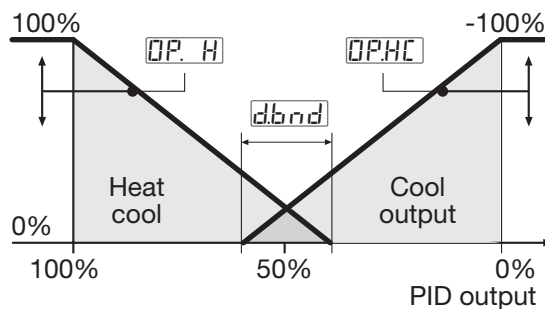

C Cool action adjusting

Example with different relative cool gains

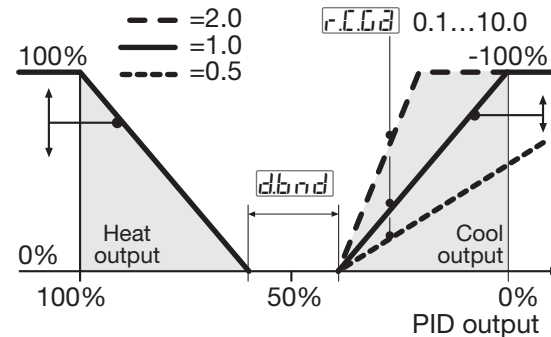

D On-Off Cool action

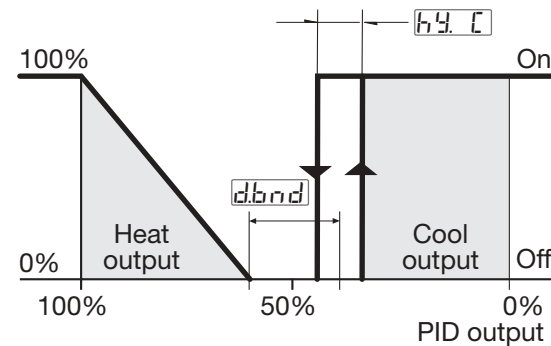

4.4.3 AUXILIARY PARAMETERS MENU

A 169

AL1
alarm hysteresis

A 269

AL2
alarm hysteresis

A 369

AL3
alarm hysteresis

Hysteresis of the threshold of both the alarms, that activate OP1 and OP2 control output. It is specified as a % of the full scale.

A 1Lb

AL1, AL2, AL3
latching

A 2Lb

and
blocking

A 3Lb

functions

For each alarm it is possible to select the following functions

none none
 L e c h latching
 b l o c blocking
 L e b l both latching
 and blocking

L e c h

ALARM

ACKNOWLEDGE FUNCTION

The alarm, once occurred, is presented on the display until to the time of acknowledge. The acknowledge operation consists in pressing any key.

After this operation, the alarm leaves the alarm state only when the alarm condition is no longer present.

b l o c

START-UP DISABLING

Ramp down

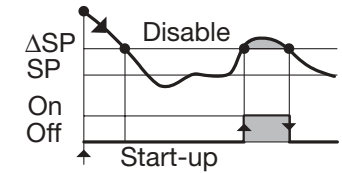

Ramp up

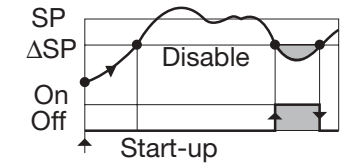

ΔSP Threshold = $SP \pm$ range

4.4.2 CONTROL MENU

ALARMS WITH LBA (LOOP BREAK ALARM) AND SENSOR BREAK OPERATION

Select the code 1 on **O** , **P** or **Q** configuration indexes (see pages 21 or 22). The following parameter is then available:

ELb3 LBA delay

Setting a value between 1 and 9999 s the alarm works as LBA+Sensor break with delay [1]

This condition is shown by means a red led as well as the blinking PV display.

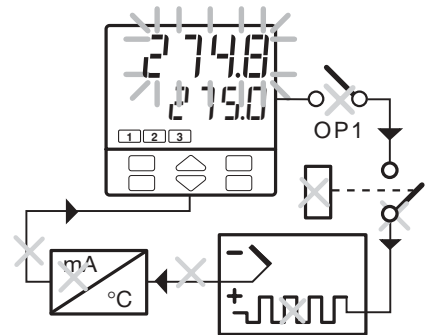

Setting OFF the alarm works as Sensor break with immediate action.

This condition is shown by means the red led of the selected alarm as well as:

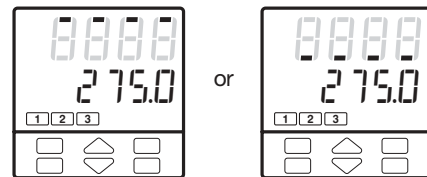

Note [1] In case of sensor break, condition, the alarm action is immediate.

When the cause of the alarm disappears, the alarm status stops.

SE.OP Soft-start control output value

Value of the control output during the Soft-start activation time.

SE.tn Soft-start activation time

Time duration (starting from the power on) of the Soft-start function.

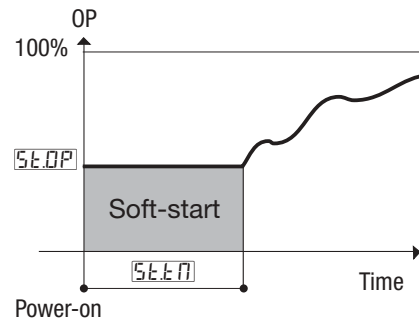

t.Fil Input filter time constant

Time constant, in seconds, of the RC input filter applied to the PV input.

When this parameter is set to OFF the filter is bypassed.

Filter response

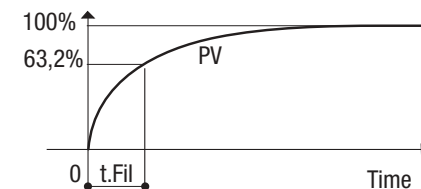

In.Sh Input shift

This value is added to the measured PV input value. Its effect is to shift the whole PV scale of up to ± 60 digits.

Addr**Controller address**

the address range is from 1 to 247 and must be unique for each controller on the communication bus to the supervisor.

When set to **OFF** the controller is not communicating

rtLo**Retransmission low range****rtHi****Retransmission high range****4.4.4 TIMER AND START-UP MENU (OPTION)**

To improve the instrument performances and to reduce the wiring and installation costs, two special functions are available:

4.4.4.1 Start-up**4.4.4.2 Timer**

In order to have the above functions the product code digit **E** must be **2** (see page 19)

For example: X3 3100-2000
To select these functions use the parameter: (see page 43).

t.NoD**Timer/Start-up operator mode**

⚠ Selecting Timer or Start-up, the Soft-start function is disabled, therefore the parameters **SEOP and **SEEN** will not be shown.** (see page 29)

4.4.4.1 START-UP FUNCTION (OPTION)

By means of this function it is possible to manipulate the control output when the controller is switched on.



To configure Start-up function the parameter

“Timer/Start-up operating mode” must be set to **1**, (see page 43)

Three parameters are associated to the Start-up function.

t.h.SU**Start-up hold time**

0...500 min.

S.P.SU**Start-up Setpoint**

(S.P. L...S.P. H)

OPHS**Control output high limit**

5.0%...100.0%

The Start-up function includes three phases:

1st “Limy” - The control output is limited to the **OPHS**

2nd “Hold” - The process variable is maintained to the Start-up Setpoint for the time fixed by the parameter **t.h.SU**

3rd “Off” - When the **t.h.SU** time is elapsed the process variable is maintained to the working Setpoint.

Whether the process variable, for any reason (e.g. load change), decreases at a value lower than (**S.P.SU** - 40 digits), the Start-up function starts again from the “Limy” phase.

4.4.4.1 START-UP FUNCTION (OPTION)

When the Start-up is in Hold phase, if the local Setpoint becomes lower than the Start-up Setpoint or if the operating mode changes to manual, the Start-up function passes to the “Off” phase.

There are two possibilities:

A Start-up Setpoint SP_{SU} lower than the local Setpoint.

The “Hold” phase starts when the process variable PV achieves the SP_{SU} (with a tolerance of 1 digit).

B Start-up Setpoint SP_{SU} greater than or equal to the local Setpoint.

When the process variable PV achieves the local Setpoint (with a tolerance of 1 digit), the Start-up function passes directly to the “Off” phase.

If, at the controller power-on, the process variable PV is greater than the lowest between the SP_{SU} and the working Setpoint, the next phase (“Hold” or “Off”) will be executed instead of the “Limy” phase.



During the “Limy” and “Hold” phases the **RUN** led is on.

A $SP_{SU} < \text{local Setpoint SP}$

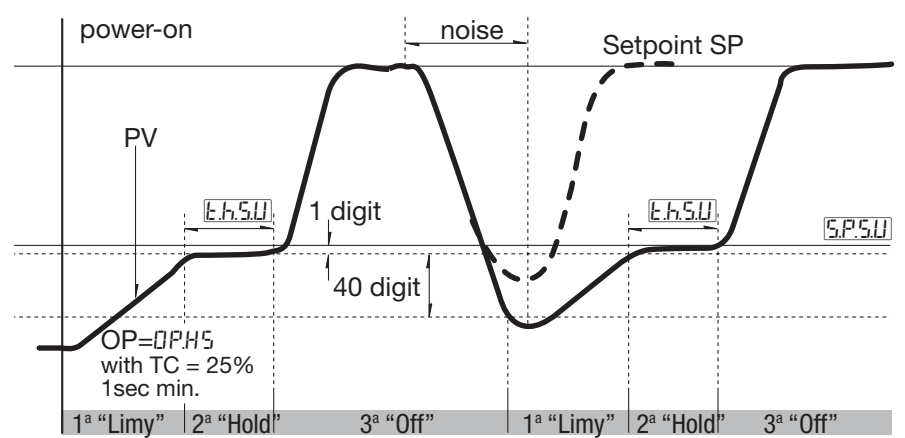

B $SP_{SU} \geq \text{local Setpoint SP}$

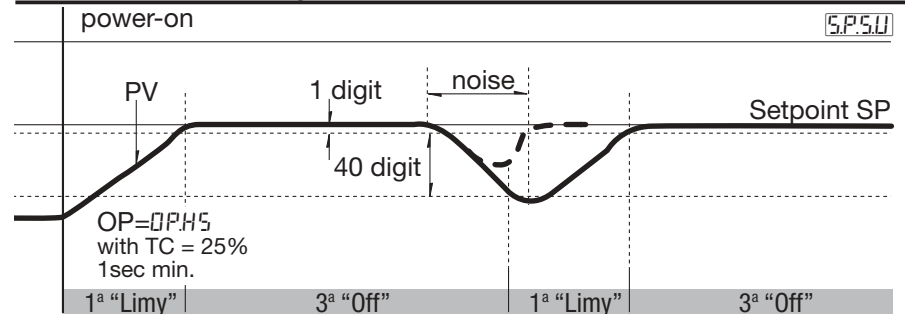

4.4.4.2 TIMER FUNCTION (OPTION)

⚠ The Timer can't be enabled with Heat / Cool control.

To enable this function do the following:

- 1 In order to use this AL3 function, index **Q** must be set to **0** in configuration (see page 22)
- 2 To select one of the 6 possible functioning modes of the Timer, set the value of the 2 following parameters in parameterisation (see p. 29).

t.No d **Timer/Start-up operating mode**

By this parameter can be defined: (see table 1)

- the counting start time
- the control output status at the end of the counting

table 1

Timer/Start-up counting mode		Value
Disabled		0 F F
Start-up function		1
Counting start time	End mode	
When inside the band	Control mode	2
	Output to 0	3
When launched	Control mode	4
	Output to 0	5
When launched. Control disabled	Control mode	6
When launched stand-by Setpoint	Control mode	7

Now the other parameter values can be entered:

t.A c t **Timer Action**

By this parameter can be defined:(see table 2)

- the time units
- the starting mode
- the OP3 status when the timer is running.

When the timer is not running, the OP3 takes the opposite status.

table 2

Time units	Starting mode	[1] OP3 status	Value
Seconds	Manual by keypad	On	0
		Off	1
	Auto at power ON [2]	On	2
		Off	3
Minutes	Manual by keypad	On	4
		Off	5
	Auto at power ON [2]	On	6
		Off	7

[1] If used by Timer

[2] Using this selection, manual starting mode is possible too.

t. n e **Timer setting**

(1...9999 s/min.)

S.P. S b **Stand-by Setpoint**

(only for t.No d = 7)
(S.P. L ...S.P. H)

4.4.4.2 TIMER FUNCTION (OPTION)

TIMER COUNTING MODES

A - Counting start time inside the band, end in control mode.

The time counting starts only when the error is inside a ± 1 digit band. The control action is not affected by the Timer function.

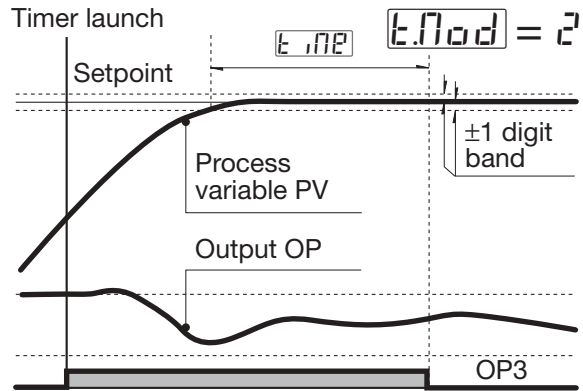
**B - Counting start time inside the band, end with control output forced to zero.**

The time counting starts only when the error is inside a ± 1 digit band. At the end, the control output is forced to zero. [1]

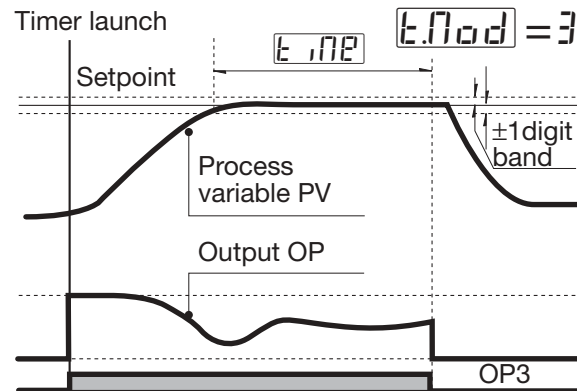
**C - Counting start time = timer launch time, end in control mode.**

The time counting starts when the timer is launched. The control action is not affected by the Timer function.

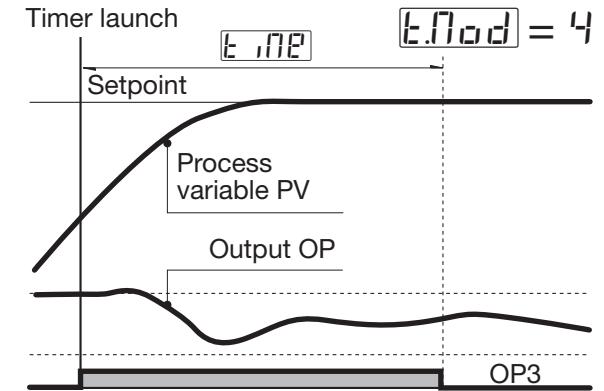

[1] When the Timer is not running the control output is forced to zero, also before the Timer launch

TIMER COUNTING MODES

D - Counting start time = timer launch time, end with control output forced to zero.

The time counting starts when the timer is launched. At the end, the control output is forced to zero. [1]

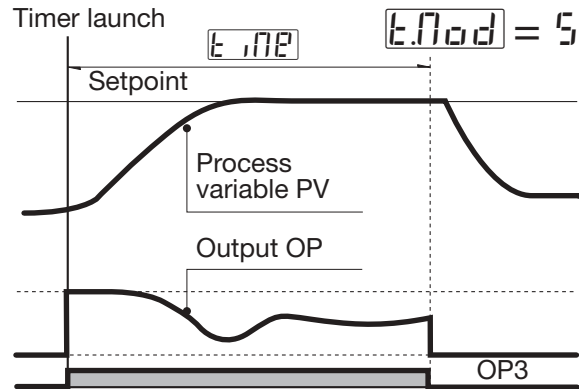

[1] When the Timer is not running the control output is forced to zero, also before the Timer launch

E - No control action during the counting time.

The time counting starts when the timer is launched and the control output is forced to zero. At the end, the control action starts.

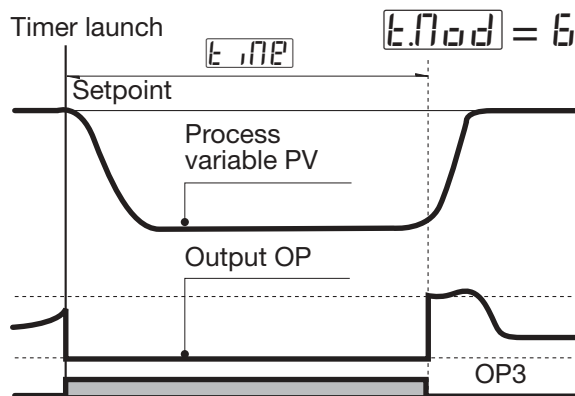

F - Control action with stand-by Setpoint during the counting time

The time counting starts when the timer is launched and the control action use the Stand-by Setpoint. At the end, the control action use the working Setpoint.

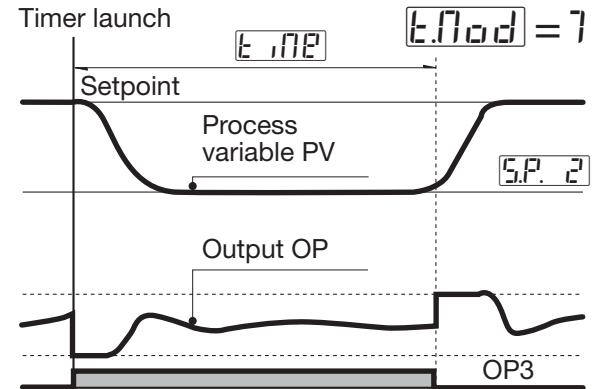

4.4.4.2 TIMER FUNCTION (OPTION)

POWER FAILURE

If there is a power failure during the Timer execution, the value of the elapsed time is lost.

Depending on Timer action `End` selection, when the controller restarts you can have two different situations:

- with automatic mode (`End` = 2, 3, 6, 7), the Timer function starts again and the counting time is reinitialised.
- with manual mode (`End` = 0, 1, 4, 5), the control output is forced to 0 if `End` = 3 e 5; otherwise the control action restarts using the working Setpoint

TIMER STARTING

See the Timer starting procedure at page 50 (chapter 6.2.2)

DISPLAY

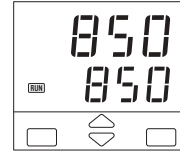

When the Timer is running, the led `RUN` is on.

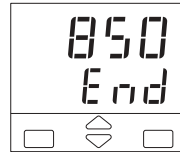

When the Timer ends, the Setpoint display shows alternatively the message `End` and the Setpoint value until a key is pressed.

TIMER REMAINING TIME

When the timer is running it is always possible to see the remaining time and to modify it.

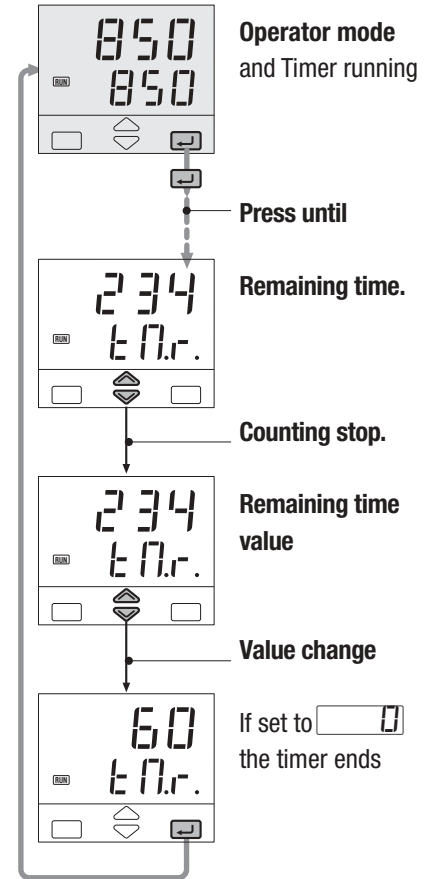

4.4.5 CONFIGURATION MENU

RETRANSMISSION

When OP5 output is present and not configured as control output, it retransmits linearised PV or SP.

On configuration (see page 31) it is possible to set

rtlr Analogue range
0-20 / 4-20

rth Retrasmitted signal
nonP P.U. / SP.

The following parameters define the low and high range of the OP5 retransmission output corresponding to 0...4mA or 20mA (see page 29):

rtlo Retransmission low range

rth1 Retransmission high range

Example:

- T/C S,
range 0...1600°C
- Output range, 4...20 mA
- Retrasmitted signal PV on 800...1200°C range

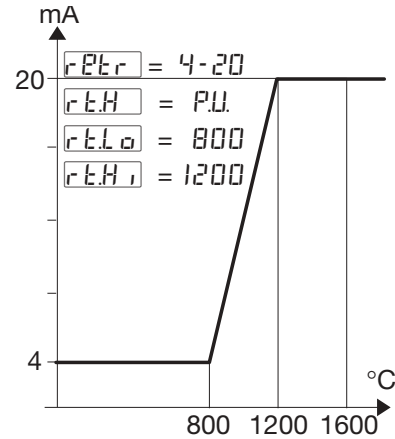

With $rtlo$ greater than $rth1$, it is possible to obtain a reverse scale.

CURRENT TRANSFORMER INPUT

With CT option, it is possible to display the load current and set an alarm threshold.

The setting can be done by means the 8 or 9 configuration index of the codes O, P or Q (see pages 21 and 22).

It is possible to set one of the alarms (see pages 21 and 22) to have an alarm when, during the ON time of the time proportional output, the load current is less than the specified threshold (index 8), or during the OFF time there is a value > 3% of full scale load current.

The alarm condition must be longer than 120 ms to set the alarm.

By the parameter

HEF.5 CT primary high range
OFF / 1...200A

the load current display can be adapted to the transformer characteristics. (OFF means disabled)

During the OFF time the parameter **ELUR** latches the last on time current value

4.4.5 CONFIGURATION MENU

CURRENT TRANSFORMER INPUT

Example:

CT input on OP1, alarm on AL2 during on time (configuration digit

P = 8 , see page 21)

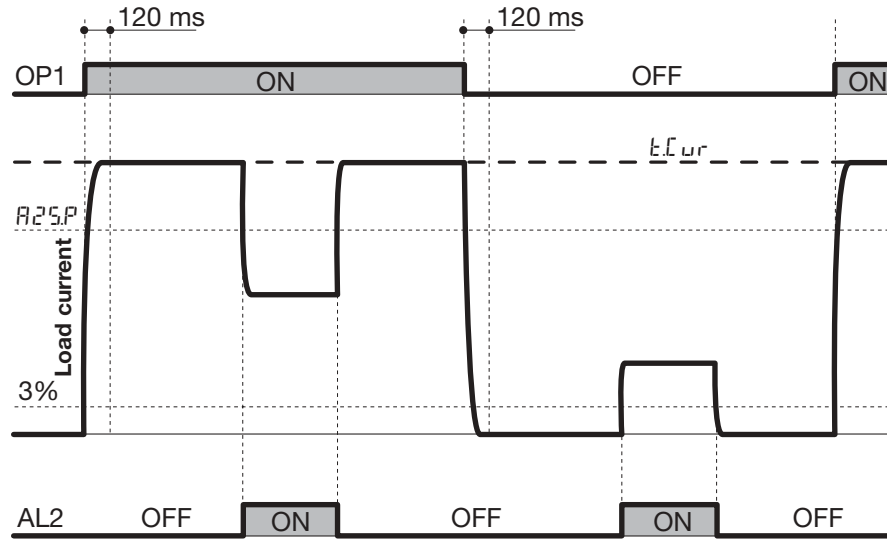

SERIAL COMMUNICATIONS

Prot

Communication protocol
Modbus/Modbus

baud

Baud rate
 1200/2400
 4800/9600

5

DISPLAYS

5.1 OF THE PROCESS VARIABLES

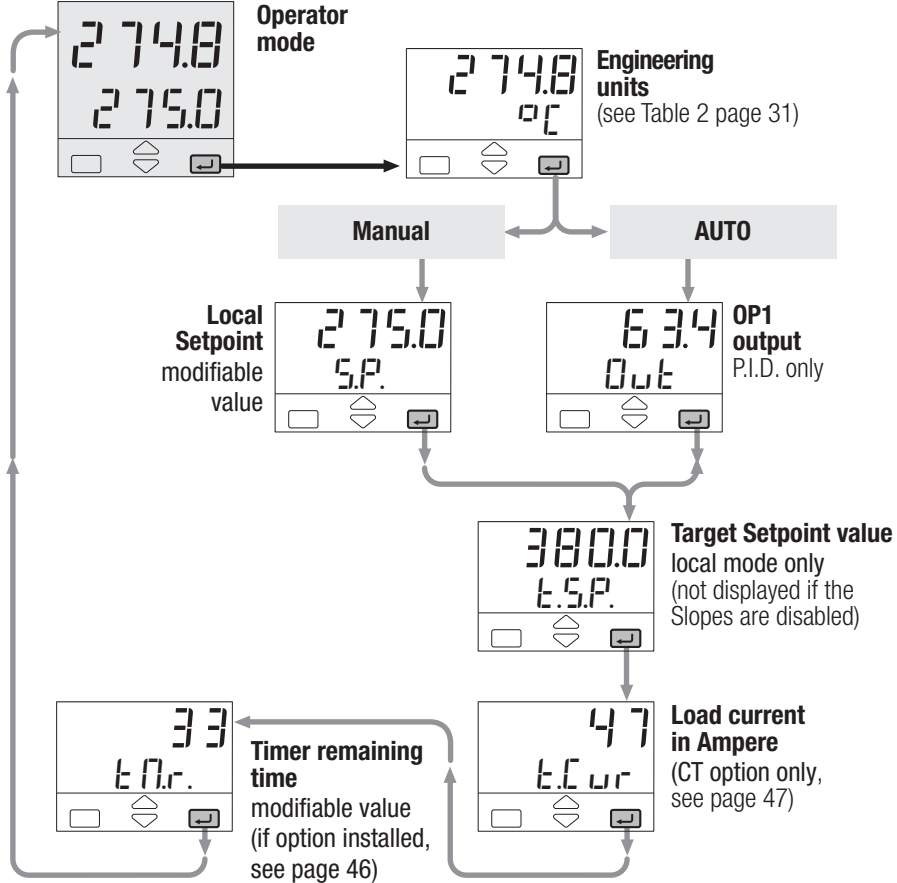

5.2 OF THE CONFIGURATION CODES

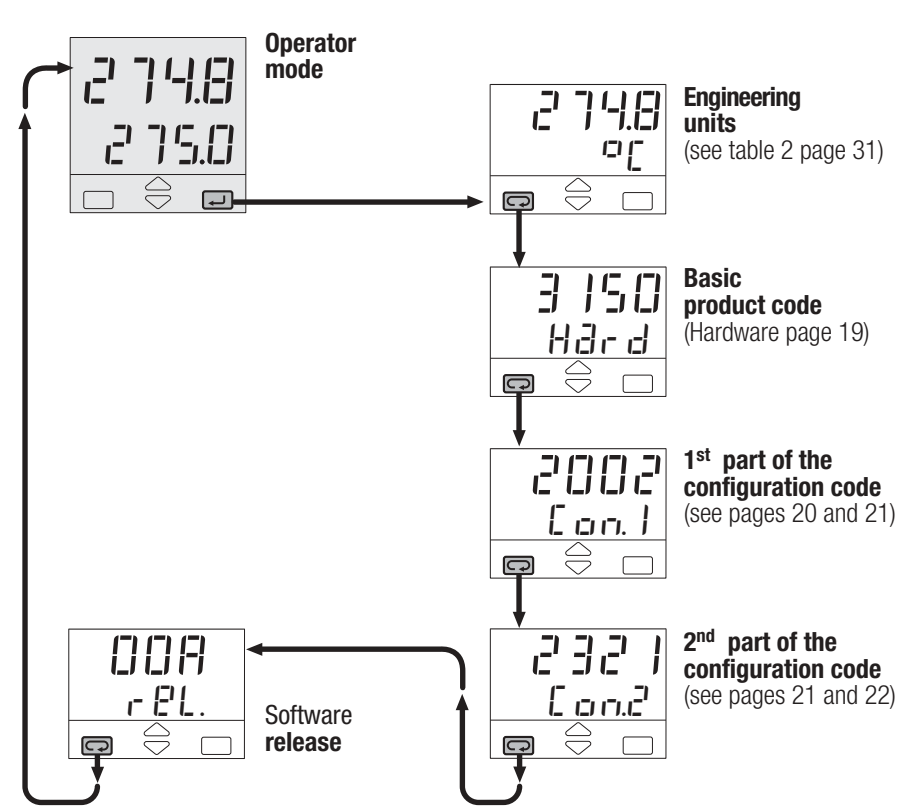

6 COMMANDS**COMMANDS TO THE CONTROLLER AND OPERATING PHASES**

The commands can be entered in 3 ways:

**6.1 KEYPAD**

see page 51

- Setpoint modification
- manual mode
- Timer start
- Program start/stop
- local/remote selection
- stored Setpoint display
- Keypad lock
- Outputs lock

6.2 DIGITAL INPUTS

see page 54

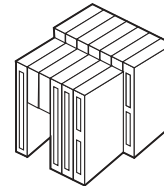
**6.3 SERIAL COMMUNICATIONS**

see the manual on this topic



6.1 KEYPAD COMMANDS

6.1.1 SETPOINT MODIFICATION

The Setpoint is directly modified with the   keys.

Once entered, the new value is checked and becomes operating after 2 seconds.. The end of this phase is flagged by flashing momentarily the display with SP.

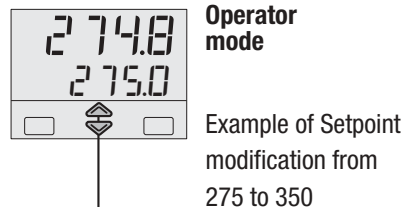

 after 2 seconds

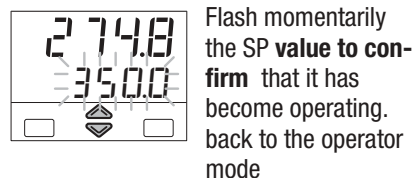

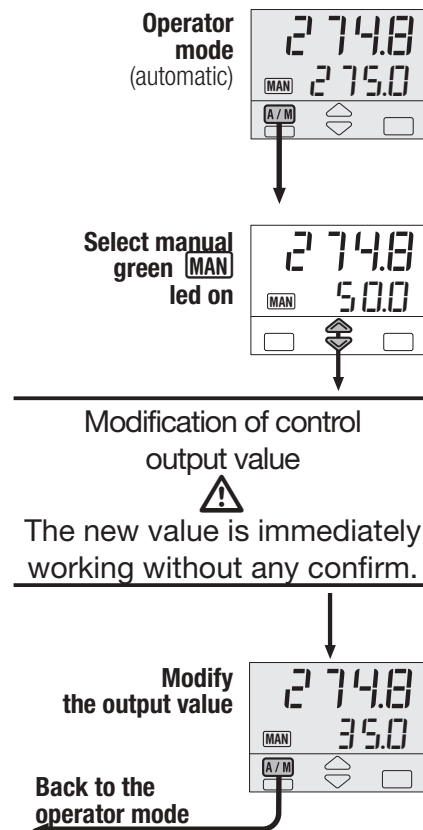

6.1.2 AUTO/MANUAL MODE

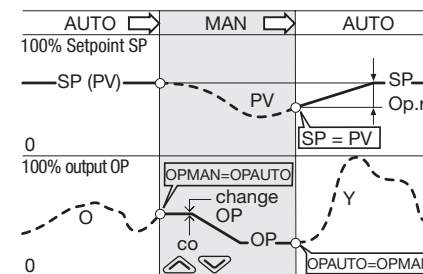

For Setpoint access and modification from Manual status, see the procedure on chapter 5 (see page 49).

The bumpless action is present switching between AUTO, MAN and vice versa.



 In case of power failure, the AUTO/MAN status and the output value remain stored in the controller memory.

6.1.3 TIMER STARTING (option)

Depending on the Timer action Event selection, there can be two different starting ways:

- Automatic at the power on
- Manual by keypad, digital inputs or serial communications.

To start/stop the Timer:

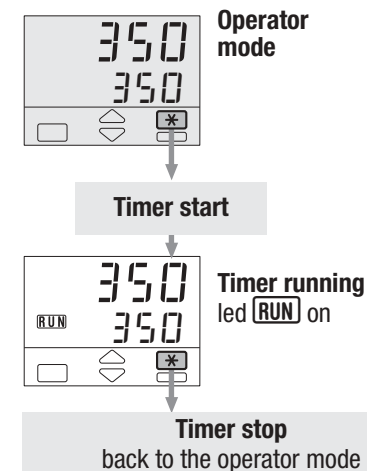

6.1 KEYPAD COMMANDS

6.1.4 PROGRAM STARTING

(see chapter 7, page 55)

6.1.5 LOC/ REM SELECTION

configuration index **R** = 4 or 5)

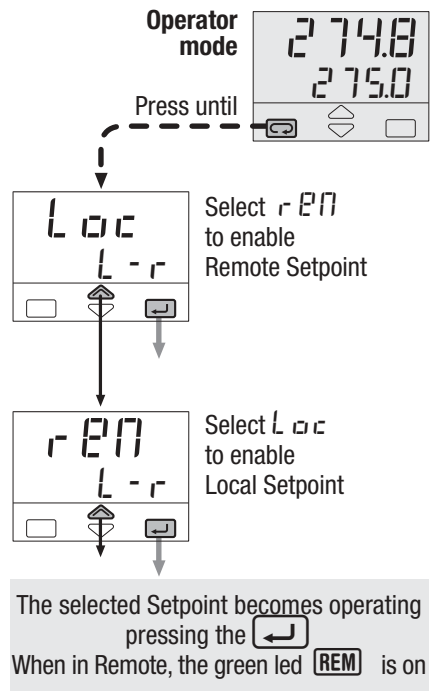

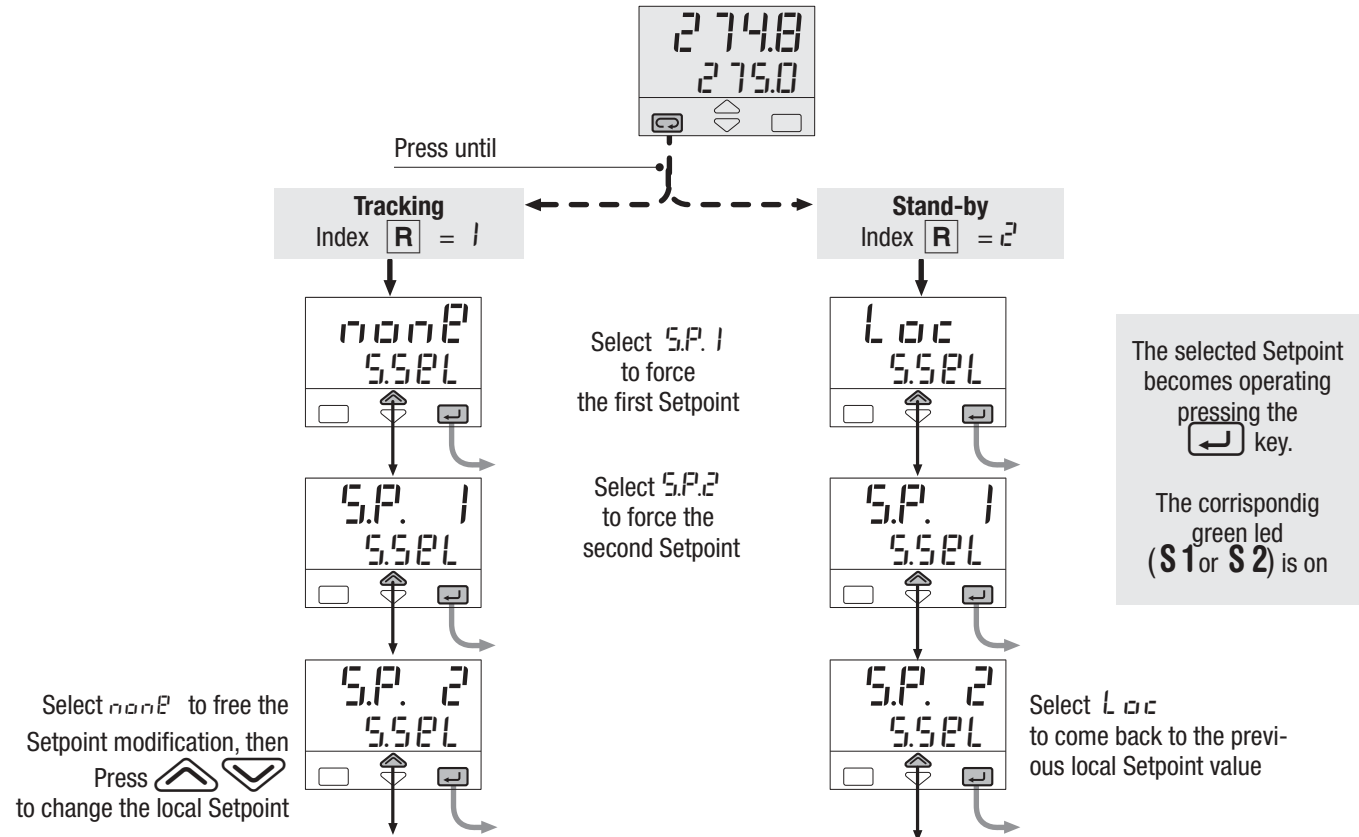

6.1.6 STORED SETPOINTS SELECTION

(configuration index **R** = 1 or 2)



6.1.7 KEYPAD LOCK

To lock/unlock the keypad press the keys  and  simultaneously for 2 seconds. To confirm the keypad lock/unlock the display flashes once.

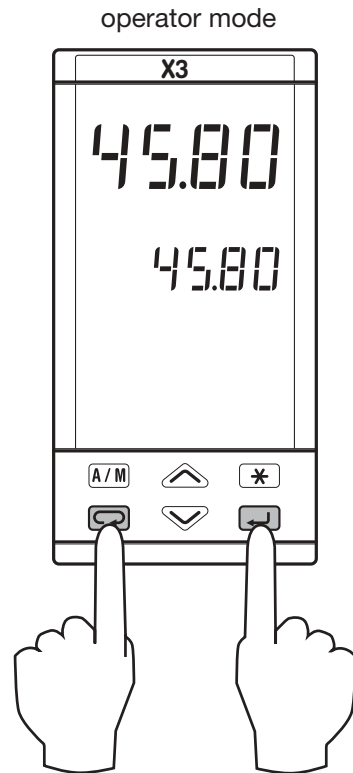

The keypad lock/unlock can be achieved by serial communications too.

 The keypad lock is maintained in case of power failure.



Press simultaneously
for 2 seconds

6.1.8 OUTPUTS LOCK

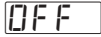
The outputs are switched to the OFF status by pressing the keys  and  together. When the outputs are locked, the message  is displayed instead of the Setpoint value.

To unlock the outputs press again the keys simultaneously (the Soft-start will be enabled).

The outputs lock/unlock can be achieved by serial communications too

 The outputs lock/unlock is maintained in case of power failure.

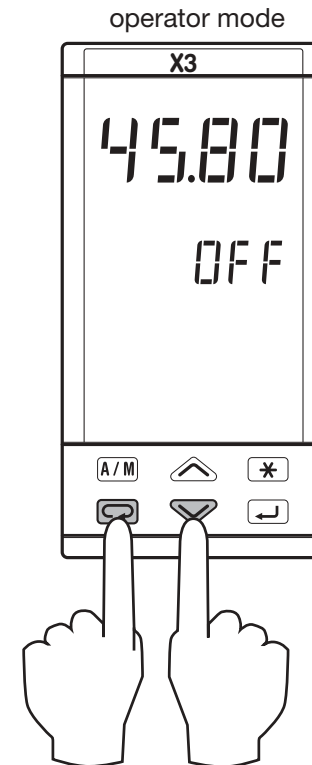











Press simultaneously
for 2 seconds

6.2 DIGITAL INPUT COMMANDS

A function is assigned, through the configuration procedure to each IL1, IL2 and IL3 digital input. (see the parameters setting at tab. 1 at page 31).

The configured function is activated when the digital input (free voltage contact or open collector output) is in the On state (closed). It is deactivated by setting the input to the Off state (open).

The activation of the function through the digital input has the highest priority than through the keypad or through the serial communication.

Function		Parameter value	Performed operation		Notes
			 Off	 On	
None			—	—	Not used
Keypad lock			Unlock	Locked	With the keypad locked the commands from digital inputs and serial communications are still operating
PV measure hold			Normal operation	PV is hold	The value of PV is “frozen” at the time the digital input goes to the close state
Set manual mode			Automatic	Manual	
Standard Setpoint	1st stored Setpoint		Local	1st SP	The permanent closure forces the chosen stored value. Setpoint modification is not possible. The impulsive closure, selects the stored value. Setpoint modification is allowed. If more than one digital input is selecting a Setpoint, the last to be activated is the operating one.
	2nd stored Setpoint		Local	2nd SP	
Set Remote mode			Local	Remote	
Timer			—	Timer start	The impulsive closure is enough to start the Timer
Programmed Setpoint	Start/stop of a program		Hold	Run	When the input is in the On state, the program is executed up to the end. When off, the program is forced in hold.

7 PROGRAMMED SETPOINT

INTRODUCTION

The controller supplied with the Setpoint programmer option (mod. X3-3...**1**) offers the functionality to define, store, display and execute a program consisting in the Setpoint profile in time.

MAIN CHARACTERISTICS

- 1 program, 8 segments/program
- start, stop, hold etc, commands from the keypad
- time base in seconds, minutes or hours
- continuous or up to 1...9999 time cycling of the program
- 1 OP3 digital output with the state profile defined by the program
- setting of the maximum allowed deviation from the Setpoint

7.1 PROGRAM STRUCTURE

The program consists of a sequence of segments.

For each segment, it is specified:

- the Setpoint to reach $S.P.$
 - the duration of the segment t_i
 - the state of the OP3 output
- } always present

The program consists of:

- 1 initial segment named I
- 1 end segment named F
- 1...6 normal segments

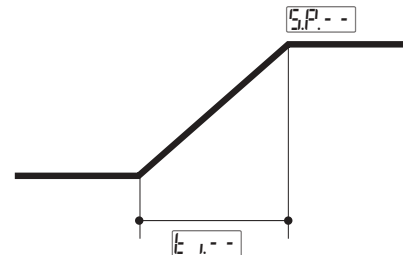

Initial segment - I

Its main purpose is to define the value the process variable has to maintain before starting the program.

End segment - F

Its main purpose is to define the value the process variable has to maintain at the end of the program and until further changes of Setpoint.

Normal segments - - - -

These segments build up the profile program. There are 3 types of segments:

Ramp

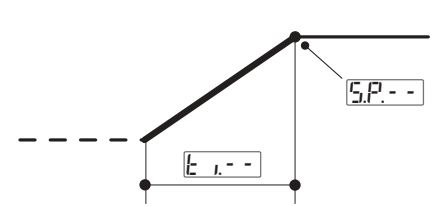

Dwell

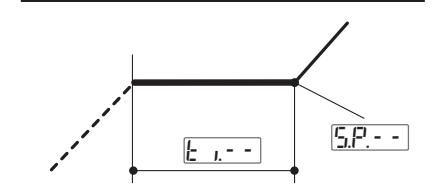

Step

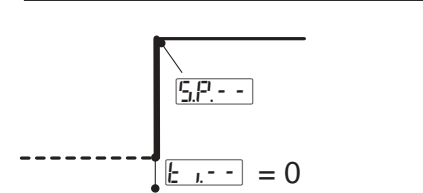

$S.P.$ = Target Setpoint

t_i = Duration

----- = Previous segment

————— = Current segmente

————— = Next segment

EXAMPLE OF SETPOINT PROFILE

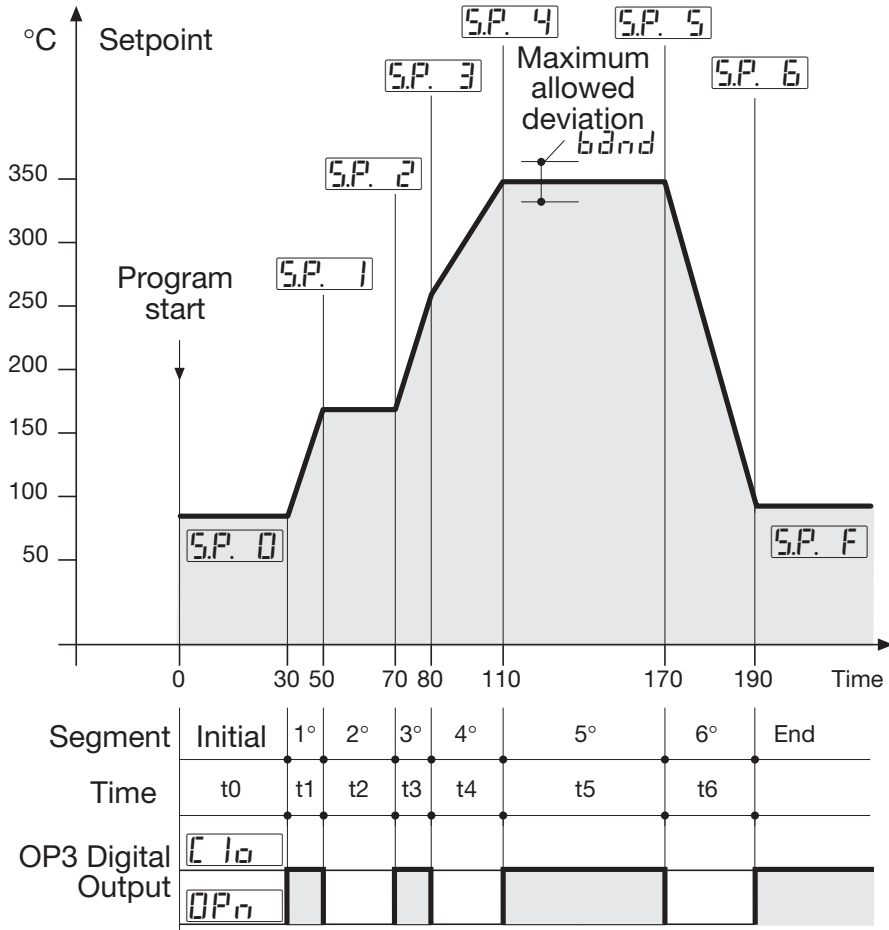

7.2 SETPOINT PROGRAMMER OPERATION

7.2.1 MAXIMUM ALLOWED DEVIATION (band)

If the PV controlled input value exceeds the band, centred around the SP, the segment time is extended of the same time the PV input stays out of the band. The band width is defined in a parameter of the program segment.

The actual segment period is calculated as $t_{i-} + Ti$

A. Ramp

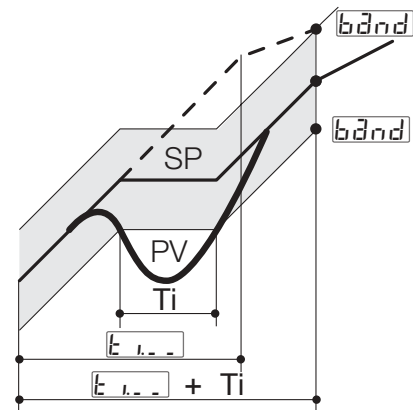

B. Dwell

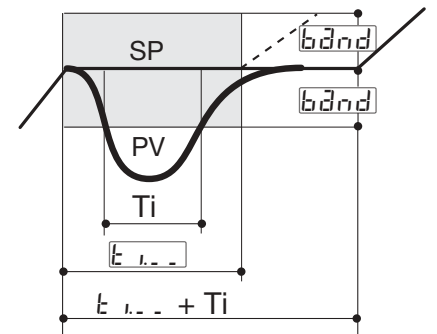

7.2 SETPOINT PROGRAMMER OPERATION

7.2.2 RE-START OF A PROGRAM AFTER A POWER FAILURE

The parameter `FAIL` specifies the behaviour of the programmer at power up (see page 58). Selected between the following 3 choices:

`Cont` Continue

`RES` Reset

`ramp` Ramp

If `Cont` is selected, the execution of the program starts from the point reached at the power failure time.

All the parameters, like Setpoint and the remaining time are restored at the values they had at power off.

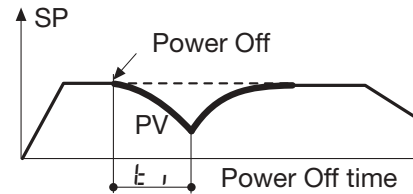

If `RES` is selected, at power on the program ends and goes back to local mode.

If `ramp` is selected, the execution of the program starts from the point reached at the power failure time.

In this case, the programs continue with PV reaching SV with a ramp, whose slope corresponds to the one of the segment running at the power off.

Power off during a dwell

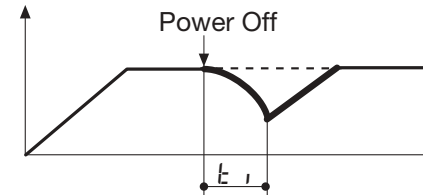

Power off during a ramp

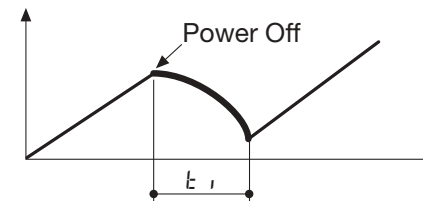

7.3 PARAMETERISATION - PROGRAM MENU (OPTION)

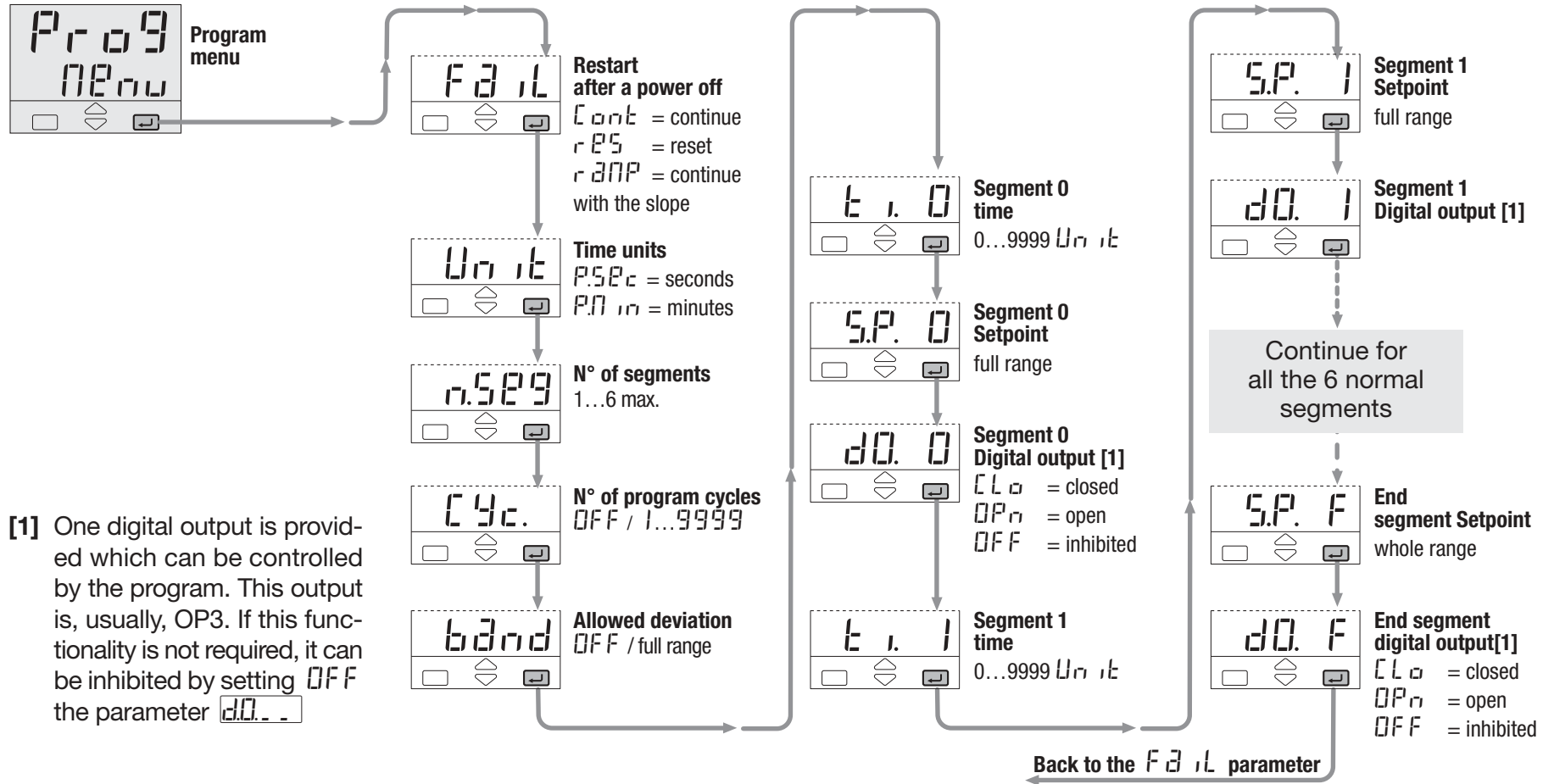

[1] One digital output is provided which can be controlled by the program. This output is, usually, OP3. If this functionality is not required, it can be inhibited by setting OFF the parameter **dO. .**

7.4 START/STOP OF A PROGRAM

The various commands, supported by the controller, are different for each of the following operating phases:

A] when in Local Setpoint mode
B] during the execution of a program

C] when the program is in hold

Commands supported by the controllers

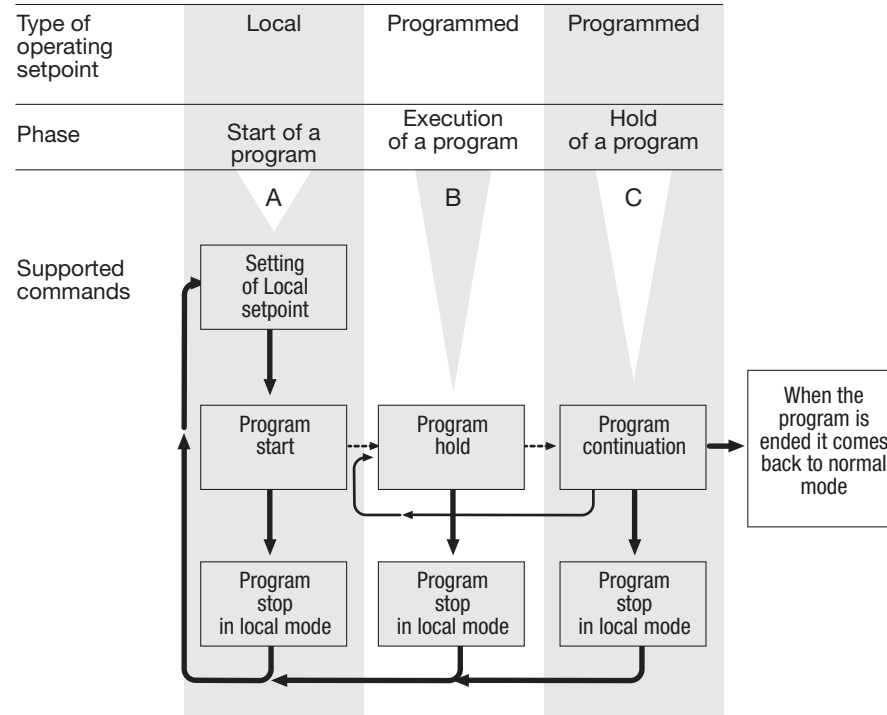

The different phase are displayed in a chained way, just for easing the understanding of the functionality.

Two different mode for starting and stopping a program are provided:

direct mode with the  key through the parameter menu

1st DIRECT MODE WITH *

2nd THROUGH THE PARAMETER MENU

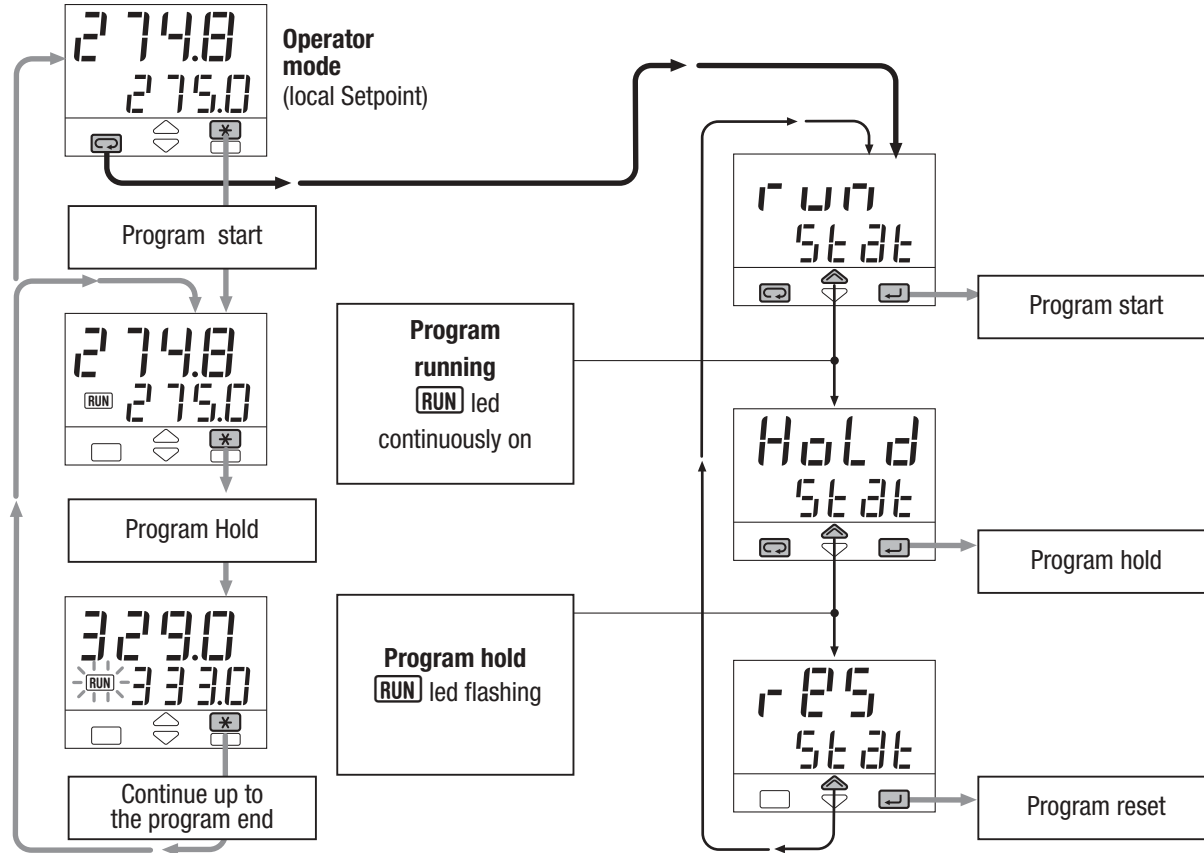

The **RUN** green led is flashed at high rate when the controlled variable is out of the allowed deviation band

The current time of a segment is hold up to the time the variable re-enter in the band.

8 TECHNICAL SPECIFICATIONS

Features (at 25°C environmental temp.)	Description			
Total configurability (see chapter 3.2 page 20 chapter 4.3.5 page 30)	From keypad or serial communication the user selects: <ul style="list-style-type: none"> - the type of input - the type of control algorithm - the type of output - the type and functionality of the alarms - the type of Setpoint - control parameter values 			
PV Input (see pages 11,12 and page 20)	Common characteristics		A/D converter with resolution of 50,000 points Update measurement time: 0.2 seconds Sampling time: 0.5 seconds Input bias: -60...+ 60 digit Input filter with enable/disable: 1...30 seconds	
	Accuracy	0.25% ±1 digits for temperature sensors 0.1% ±1 digits (for mV and mA)	Between 100...240Vac the error is minimal	
	Resistance thermometer (for ΔT: R1+R2 must be <320Ω)	Pt100Ω at 0°C (IEC 751) °C/°F selectable	2 or 3 wires connection Burnout (with any combination)	Max. wire Res: 20Ω max. (3 wires) Input drift: 0.35°C/10° Env. Temp. <0.35°C/10Ω Wire Res.
	Thermocouple	L,J,T,K,S, R, B, N, E, W3, W5 (IEC 584) R _j >10MΩ °C/°F selectable	Internal cold junction compensation con NTC Error 1°C/20°C ±0.5°C Burnout	Line: 150Ω max. Input drift: <2μV/°C Env. Temp. <5μV/10Ω Wire Res.
	DC input (current)	4...20mA, 0...20mA with external shunt 2.5Ω R _j >10MΩ	Burnout. Engineering units Conf. decimal point position Init. Scale -999...9999	Input drift: <0.1%/20°C Env. Temp.
	DC input (voltage)	10...50mV, 0...50mV R _j >10MΩ	Full Scale -999...9999 (min. range of 100 digits)	

Features (at 25°C environmental temp.)		Description						
Auxiliary inputs	Remote Setpoint (option) Not isolated accuracy 0.1%	Current 0/4...20mA Rj = 30Ω	Bias in engineering units and ± range Ratio from -9.99...+99.99 Local + Remote Setpoint					
		Voltage 1...5/0...5/0...10V Rj = 300KΩ						
	CT current transformer (see pages 13 and 47)	50 or 100 mA input hardware selectable	Current visualisation 10...200A With 1A resolution and Heater Break Alarm					
Digital inputs 3 logic	The closure of the external contact produces any of the following actions:		Auto/Man mode change, Local/Remote Setpoint mode change, Stored Setpoints activation, keypad lock, measure hold					
			Timer activation, program run/hold (if options installed)					
Operating mode and Outputs	1 single or double action P.I.D. loop or On/Off with 1, 2 or 3 alarms	Single action	Control output		AL1 alarm	AL2 alarm	AL3 alarm	Retransmiss.
			OP1 -Relay/Triac			OP2 -Relay/Triac	OP3 -Relay	OP5 -Analogue
			OP4 -SSR drive-Relay		OP1 -Relay/Triac	OP2 -Relay/Triac	OP3 -Relay	OP5 -Analogue
				OP5 -Analogue	OP1 -Relay/Triac	OP2 -Relay/Triac	OP3 -Relay	
		Double action Heat / Cool	OP1 -Relay/Triac	OP2 -Relay/Triac			OP3 -Relay	OP5 -Analogue
			OP1 -Relay/Triac	OP4 -SSR drive-Relay		OP2 -Relay/Triac	OP3 -Relay	OP5 -Analogue
			OP4 -SSR drive-Relay	OP2 -Relay/Triac	OP1 -Relay/Triac		OP3 -Relay	OP5 -Analogue
			OP1 -Relay/Triac	OP5 -Analogue		OP2 -Relay/Triac	OP3 -Relay	
			OP5 -Analogue	OP2 -Relay/Triac	OP1 -Relay/Triac		OP3 -Relay	
			OP5 -Analogue	OP4 -SSR drive-Relay	OP1 -Relay/Triac	OP2 -Relay/Triac	OP3 -Relay	
Valve drive	OP1 -Relay/Triac	OP2 -Relay/Triac			OP3 -Relay	OP5 -Analogue		

Features (at 25°C environmental temp.)	Description				
Control mode	Algorithm	P.I.D. with overshoot control or On-off - P.I.D. with valve drive algorithm, for controlling motorised positioners			
	Proportional band (P)	0.5...999.9%			
	Integral time (I)	0.1...100.0 min	OFF = 0		
	Derivative time (D)	0.01...10.00 min			
	Error dead band	0.1...10.0 digit			
	Overshoot control	0.01...1.00		Single action P.I.D. algorithm	
	Manual reset	0.0...100.0%			
	Cycle time (Time proportional only)	1...200 s			
	Control output high limit	10.0...100.0%			
	Soft-start output value	0.1...100.0%	OFF = 0		
	Output safety value	0.0...100.0% (-100.0...100.0% for Heat / Cool)			
	Control output hysteresis	0.1...10.0%			On-Off algorithm
	Dead band	-10.0...10.0%			
	Relative cool gain	0.1...10.0		Double action P.I.D. algorithm (Heat / Cool) with overlap	
	Cycle time (Time proportional only)	1...200 s			
	Control output high limit	10.0...100.0%			
	Cool output hysteresis	0.1...10.0%			
	Motor travel time	15...600 s		Valve drive P.I.D. algorithm without feedback potentiometer	
Motor minimum step	to 0.1...5.0%				

Features (at 25°C environmental temp.)		Description				
OP1-OP2 outputs		SPST Relay N.O., 2A/250Vac (4A/120Vac) for resistive load Triac, 1A/250Vac for resistive load				
OP3 output		SPDT relay N.O., 2A/250Vac (4A/120Vac) for resistive load				
OP4 output		Logic not isolated: 0/5Vdc, ±10% 30mA max. - SPST Relay N.O., 2A/250Vac (4A/120Vac) for resistive load				
OP5 analogue output (option)		Control or PV/SP retransmission	Galvanic isolation: 500 Vac/1 min Resolution 12bit (0.025%) Accuracy: 0.1 % In current: 0/4...20mA 750Ω/15V max.			
AL1 - AL2 - AL3 alarms		Hysteresis 0.1...10.0% c.s.				
		Action	Active high	Action type	Deviation threshold	±range
			Active low		Band threshold	0...range
		Special functions	Sensor break, heater break alarm		Absolute threshold	whole range
			Acknowledge (latching), activation inhibit (blocking)			
Connected to Timer or program (if options installed)						
Setpoint		Local		Up and down ramps 0.1...999.9 digit/min. (OFF=0) Low limit: from low range to high limit High limit: from low limit to high range		
		Local plus two stored (tracking or STAND-BY)				
		Local and Remote				If option installed
		Local with trim				
		Remote with trim				
		Programmable				

Features (at 25°C environmental temp.)	Description		
Programmable Setpoint (optional)	1 program, 8 segments (1 initial and 1 end) - From 1 to 9999 cycles or continuous cycling (DFF) Start, stop, hold, etc. activated from the keypad, digital input and serial communications		
Special functions (option)	Timer (see page 43)	Automatic start at the power on, manual start by keypad, Digital inputs or serial comm.s	
		Setting time: 1...9999 s/min.	
	Start-up (see page 41)	Stand-by Setpoint: from Setpoint low limit to Setpoint high limit	
		Start-up Setpoint: from Setpoint low limit to Setpoint high limit	
Hold time: 0...500min.			
Control output high limit: 5.0...100.0%			
Fuzzy-Tuning one shoot	The controller selects automatically the best method according to the process conditions	Step response Natural frequency	
Auto/Man station	Standard with bumpless function, by keypad, digital input or serial communications		
Serial comm. (option)	RS485 isolated, Modbus/Jbus protocol, 1200, 2400, 4800, 9600 bit/s, 3 wires		
Auxiliary Supply	+24Vdc \pm 20% 30mA max. - for external transmitter supply		
Operational Safety	Measure input	Detection of out of range, short circuit or sensor break with automatic activation of the safety strategies and alerts on display	
	Control output	Safety value: -100...100%	
	Parameters	Parameter and configuration data are stored in a non volatile memory for an unlimited time	
	Access protection	Password to access the configuration and parameters data, keypad lock, outputs lock	
General characteristics	Power supply (PTC protected)	100...240Vac (-15...+10%) 50/60 Hz or 24Vac (-25...+12%), 50/60 Hz and 24Vdc (-15...+25%)	Power consumption 4W max.
	Safety	Compliance to EN61010-1 (IEC 1010 – 1), installation class 2 (2500V) pollution class 2, instrument class II	
	Electromagnetic compatibility	Compliance to the CE standards (see page 2)	
	UL and cUL Omologation	File 176452	
	Protection EN60529 (IEC 529)	IP65 front panel	
Dimensions	1/8 DIN - 48 x 96, depth 110 mm, weight 250 g approx.		

























WARRANTY











We warrant that the products will be free from defects in material and workmanship for 18 months from the date of delivery.

The warranty above shall not apply for any failure caused by the use of the product not in line with the instructions reported on this manual.

ICONS TABLE

Main universal input	
	Thermocouple
	RTD (Pt100)
	Delta Temp (2x RTD)
	mA and mV
	Custom
	Frequency
Auxiliary input	
	Current transformer
	mA Remote setpoint
	Volt Remote setpoint
	Feedback potentiometer

Digital input	
	Isolated contact
	NPN open collector
	TTL open collector
Setpoint	
	Local
	Stand-by
	Keypad lock
	Outputs lock
	Start-up function
	Timer function
	Memorized
	Remote
	Setpoint programmer

Digital input connected functions	
	Auto/Manual
	Run, Hold, Reset and program selection
	PV hold
	Setpoint slopes inhibition
Output	
	SPST Relay
	Triac
	SPDT Relay
	mA
	mA mV
	Logic