



## Main

Range	TeSys
Product name	TeSys GV3
Device short name	GV3L
Device application	Motor
Poles description	3P
Network type	AC
Utilisation category	Category A conforming to IEC 60947-2 AC-3 conforming to IEC 60947-4-1
Network frequency	50/60 Hz
Breaking capacity	50 kA Icu at 440 V AC 50/60 Hz 12 kA Icu at 500 V AC 50/60 Hz 6 kA Icu at 690 V AC 50/60 Hz 50 kA Icu at 400/415 V AC 50/60 Hz 65 kA Icu at 230/240 V AC 50/60 Hz
[Ics] rated service short-circuit breaking capacity	100 % at 230/240 V AC 50/60 Hz 50 % at 500 V AC 50/60 Hz 50 % at 690 V AC 50/60 Hz 60 % at 400/415 V AC 50/60 Hz 60 % at 440 V AC 50/60 Hz
Trip unit technology	Magnetic
Magnetic tripping current	1120 A

## Complementary

Fixing mode	35 mm symmetrical DIN rail: clipped Panel: screwed (with 3 x M4 screws)
Operating position	Any position, no direct mounting with contactor, use cable length > 10 cm Any position, do not use with accessory GV3S
Motor power kW	45 kW at 400/415 V AC 50/60 Hz maximum peak current 750 A 55 kW at 690 V AC 50/60 Hz maximum peak current 750 A 45 kW at 500 V AC 50/60 Hz maximum peak current 750 A
Control type	Rotary knob

Disclaimer: This documentation is not intended as a substitute for and is not to be used for determining suitability or reliability of these products for specific user applications

[Ue] rated operational voltage	690 V AC 50/60 Hz conforming to IEC 60947-2
[Ui] rated insulation voltage	690 V AC 50/60 Hz conforming to IEC 60947-2
[Uimp] rated impulse withstand voltage	6 kV IEC 60947-2
Power dissipation per pole	8 W
Mechanical durability	50000 cycles
Electrical durability	20000 cycles for AC-3 at 415 V In
Maximum operating rate	25 cyc/h
Connections - terminals	EverLink BTR screw connectors 1 cable(s) 1...35 mm <sup>2</sup> solid EverLink BTR screw connectors 2 cable(s) 1...25 mm <sup>2</sup> solid EverLink BTR screw connectors 1 cable(s) 1...35 mm <sup>2</sup> flexible with cable end EverLink BTR screw connectors 2 cable(s) 1...25 mm <sup>2</sup> flexible with cable end EverLink BTR screw connectors 1 cable(s) 1...35 mm <sup>2</sup> flexible EverLink BTR screw connectors 2 cable(s) 1...25 mm <sup>2</sup> flexible
Tightening torque	5 N.m on EverLink BTR screw connectors for cable 25 mm <sup>2</sup> 8 N.m on EverLink BTR screw connectors for cable 35 mm <sup>2</sup>
Mechanical robustness	Shocks: 30 Gn for 11 ms opened conforming to IEC 60068-2-27 Vibrations: 4 Gn, 5...300 Hz conforming to IEC 60068-2-6 Shocks: 5 Gn for 11 ms closed conforming to IEC 60068-2-27
Suitability for isolation	Yes conforming to IEC 60947-1
Height	132 mm
Width	55 mm
Depth	136 mm
Net weight	0.96 kg
Colour	Grey (SE GREY 6) Green (SE GREEN 2)

## Environment

Standards	EN/IEC 60947-2 EN/IEC 60947-4-1
Product certifications	IECEE CB Scheme CCC EAC ABS LROS (Lloyds register of shipping) DNV-GL BV
Protective treatment	TH
IP degree of protection	IP20 conforming to IEC 60529
IK degree of protection	IK09
Ambient air temperature for operation	-20...60 °C
Ambient air temperature for storage	-40...80 °C
Fire resistance	960 °C conforming to IEC 60695-2-1
Operating altitude	0...3000 m

## Offer Sustainability

Sustainable offer status	Green Premium product
REACH Regulation	<a href="#">REACH Declaration</a>
EU RoHS Directive	Compliant <a href="#">EU RoHS Declaration</a>
Mercury free	Yes
RoHS exemption information	<a href="#">Yes</a>
China RoHS Regulation	<a href="#">China RoHS declaration</a> Product out of China RoHS scope. Substance declaration for your information
Environmental Disclosure	<a href="#">Product Environmental Profile</a>
Circularity Profile	No need of specific recycling operations
WEEE	The product must be disposed on European Union markets following specific waste collection and never end up in rubbish bins

Contractual warranty

---

Warranty	18 months
----------	-----------

---

Tripping Curves for GV3L Combined with Thermal Overload Relay LRD33

Average Operating time at 20 °C without Prior Current Flow

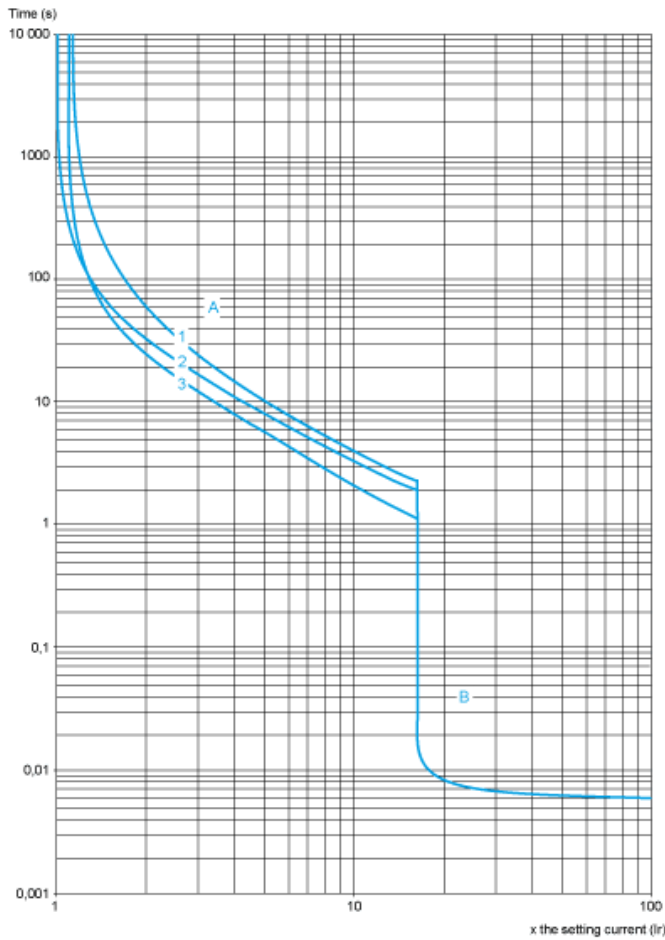

- 1 3 poles from cold state
- 2 2 poles from cold state
- 3 3 poles from hot state
- A Thermal overload relay protection zone
- B GV3L protection zone

Current Limitation on Short-Circuit for GV3L (3-Phase 400/415 V)

Dynamic Stress

$I_{peak} = f(\text{prospective } I_{sc}) \text{ at } 1.05 U_e = 435 \text{ V}$

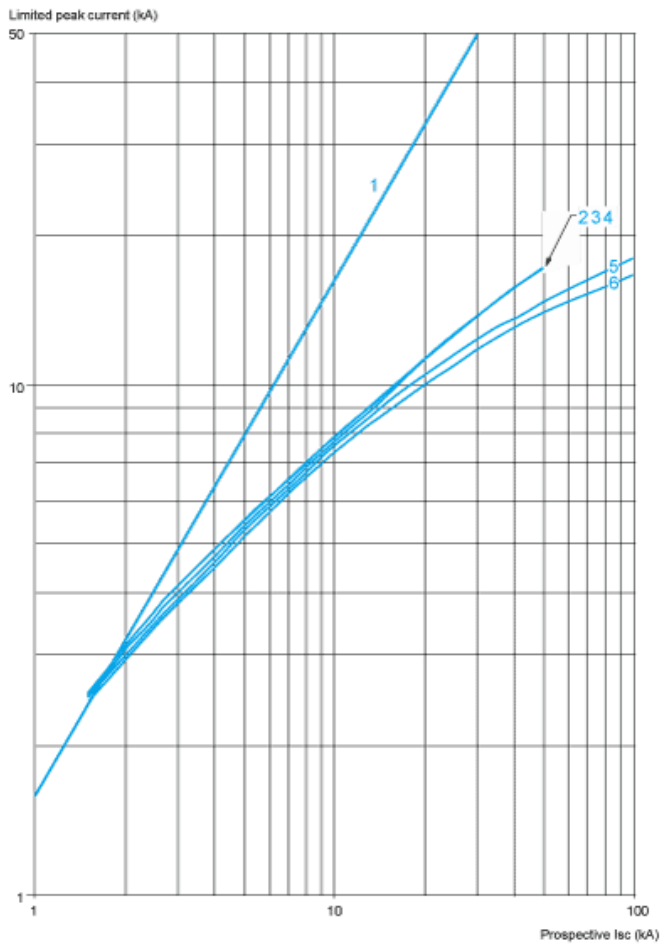

- 1 Maximum peak current
- 2 GV3L80 - GV3L73 - GV3L65
- 3 GV3L50
- 4 GV3L40
- 5 GV3L32
- 6 GV3L25

### Thermal Limit on Short-Circuit for GV3L

Thermal Limit in  $A^2s$

Sum of  $I^2dt = f$  (prospective Isc) at 1.05 Ue = 435 V

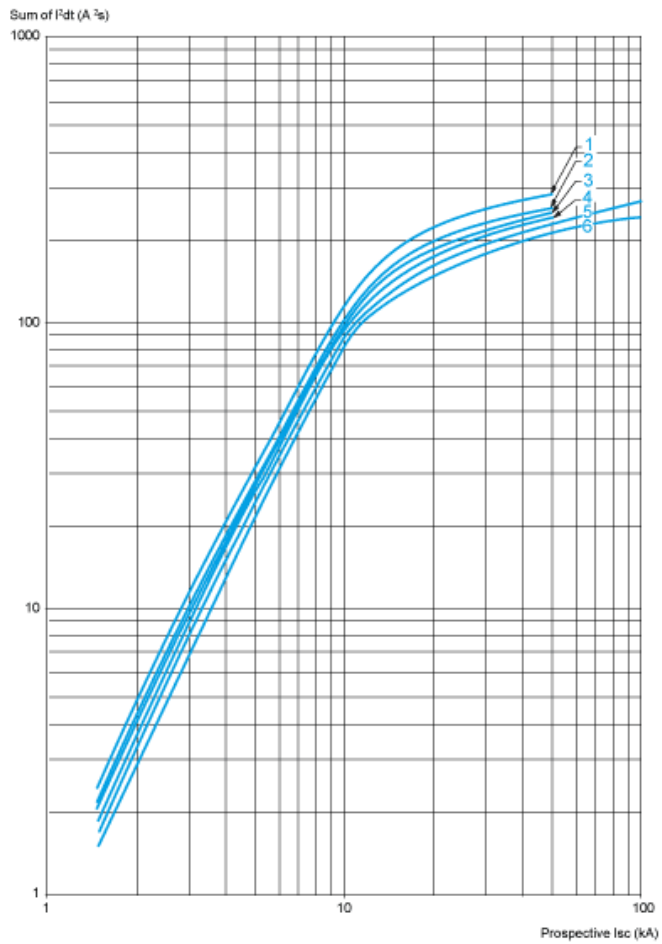

- 1 GV3L73 - GV3L80
- 2 GV3L65
- 3 GV3L50
- 4 GV3L40
- 5 GV3L32
- 6 GV3L25

GV3L, GV3P

Dimensions

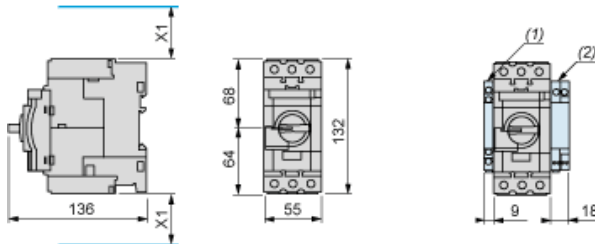

- (1) Blocks GVAN... GVAD... and GVAM11.
- (2) Blocks GV3AU... and GV3AS...

X1 = Electrical clearance (ISC max) 40 mm for  $U_e \leq 500$  V, 50 mm for  $U_e \leq 690$  V

NOTE: Leave a space of 9 mm between 2 circuit breakers: either an empty space or side-mounting add-on contact blocks. Side by side mounting is possible up to 40 °C.

Mounting with Tesys contactor LC1D40A...D80A and relay LR3D313...380 <sup>(1) (2) (3)</sup>

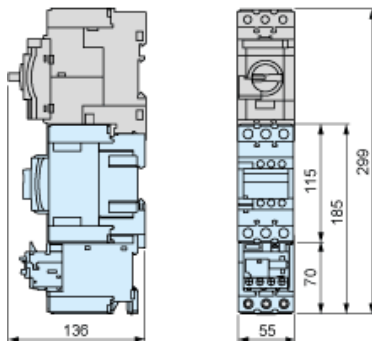

- (1) Mountings with c.b. up to GV3L73, GV3P73.
- (2) For GV3L80, GV3P80 use cable between components for dissipating heat. Consult online datasheets for values.
- (3) S-shape busbar system suitable up to 73 A.

Side by side mounting with Tesys contactor LC1D40A...D73A (S-shape busbar system GV3S<sup>(1)</sup>)

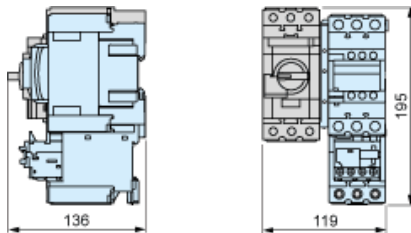

- (1) Mountings with c.b. up to GV3L73, GV3P73.

Mounting on Rail AM1 DE200 or AM1 ED201

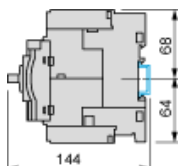

Panel Mounting, using M4 Screws

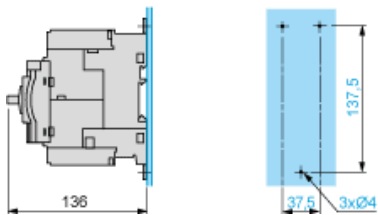

Mounting on Pre-Slotted Plate AM1 PA

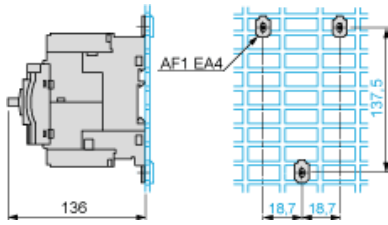

Mounting of External Operator GV3APN01, GV3APN02 or GV3APN04 for Motor Circuit Breakers GV3L

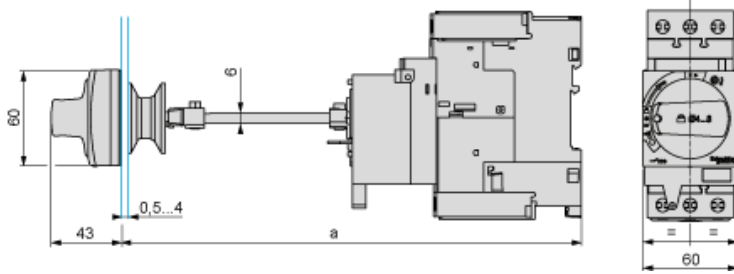

Door cut-out

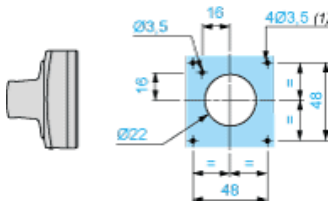

(1) For IP65 only.

Mounting of External Operator GVAPH03 for Motor Circuit Breakers GV3L

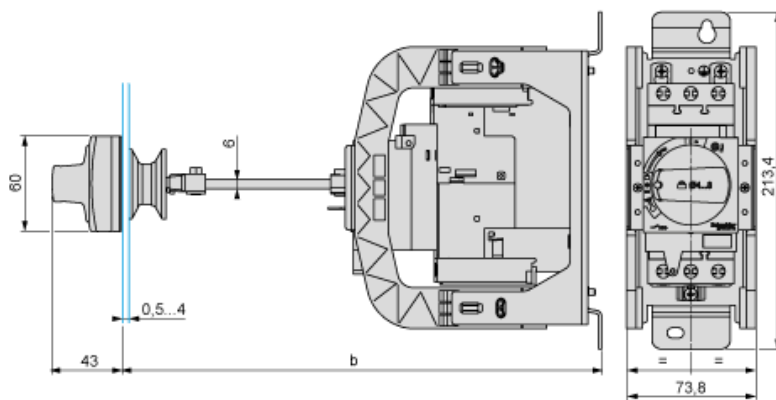

	b	
	Minimum	Maximum
GV3APN.. + GVAPH03	200	300
GV3APN.. + GVAPH03 + GVAPK12	300	492



Door cut-out

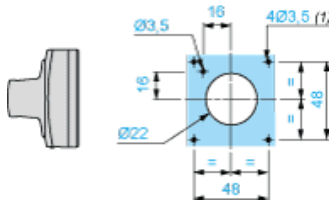

(1) For IP65 only.

GV3L••

