



Low Voltage Switches

Fusegear

DIN-type HRC-fuse links, 2...1600 A
gG- and aM- types

Power and productivity
for a better world™





HRC-fuse links gG 2...1600 A

DIN-type HRC fuse links, gG

OFAF_H_, OFAA_GG_ and OFAA_H_



DIN-size	000	00	0	1	2	3	4
OFAF_H_ / I _n [A] / 500 V	2...100	125...160	6...250	16...355	25...500	250...800	400...1250
OFAA_GG_ / I _n [A] / 690 V	2...63	80...125	6...200	16...250	32...500	250...500	500...1250
OFAA_H_ / I _n [A] / 690 V		2...125		16...250	160...400	315...630	

DIN-type HRC fuse links aM

OFAF_AM_, OFAM_AM_ and OFAA_AM_

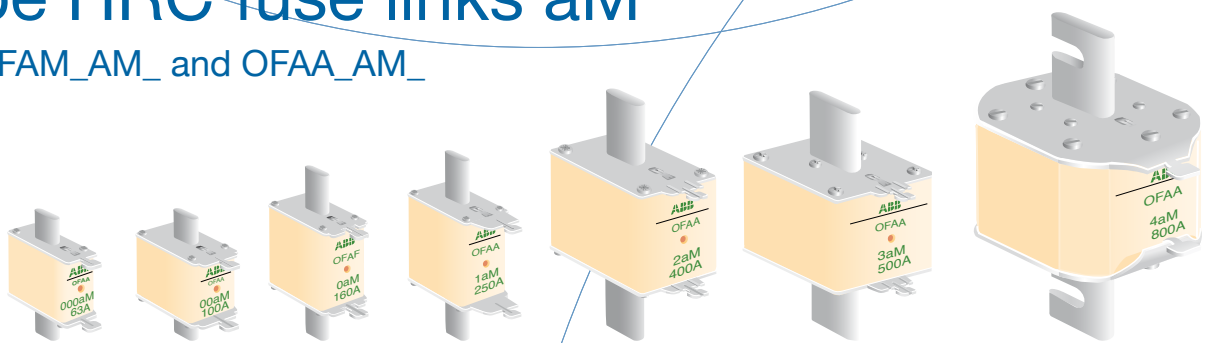

DIN-size	000	00	0	1	2	3	4
OFAF_AM_ / I _n [A] / 500 V	2...160	80...160	6...200	16...315	35...500	250...800	400...1250
OFAM_AM_ / I _n [A] / 690 V	2...63	2...160		50...250	125...400	315...800	500...1000
OFAA_AM_ / I _n [A] / 690 V		80...160		50...250	125...400	315...500	



HRC-fuse links gG, aM

OFAF_

OFAA_

OFAM_

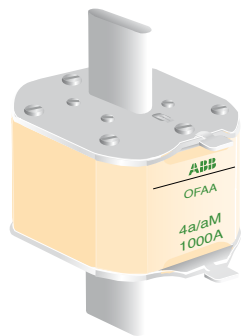
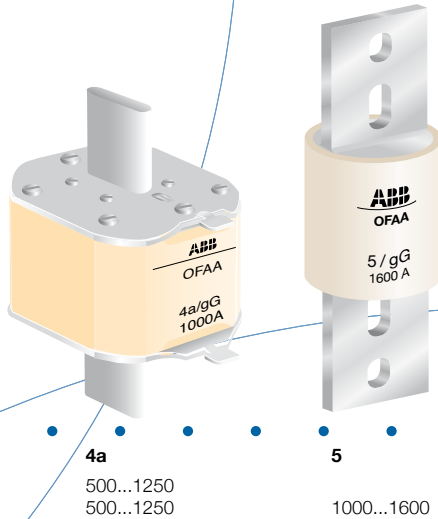

Contents:

Features	4-5
Technical data	6
Ordering information	
gG-types, for overload and short circuit protection	
500 V, gG, universal fuses OFAF_H_.....	7-8
690 V, gG, universal fuses OFAA_GG_.....	9-10
690 V, gG, universal fuses OFAA_H_.....	11
690 V, gG, for demanding industrial environment OFAA_H_-H20.....	12
aM-types, for short circuit protection in motor circuits	
500 V, aM, OFAF_AM_.....	13-14
690 V, aM, OFAM_AM_.....	15
690 V, aM, OFAA_AM_.....	16
690 V, aM, for demanding industrial environment OFAM_AM_-H20.....	17
Accessories	18
Time-current characteristics	
gG-types	
500 V, gG, OFAF_H_.....	19
690 V, gG, OFAA_GG_.....	20
690 V, gG, OFAA_H_, OFAA_H_-H20.....	21
aM-types	
500 V, aM, OFAF_AM_.....	22
690 V, aM, OFAM_AM_, OFAM_AM_-H20.....	23
690 V, aM, OFAA_AM_.....	24
Cut-off current characteristics	
gG-types	
500 V, gG, OFAF_H_.....	25
690 V, gG, OFAA_GG_.....	26-27
690 V, gG, OFAA_H_, OFAA_H_-H20.....	28
aM-types	
500 V, aM, OFAF_AM_.....	29
690 V, aM, OFAM_AM_, OFAM_AM_-H20.....	30
690 V, aM, OFAA_AM_.....	31
I²t characteristics	
gG-types	
500 V, gG, OFAF_H_.....	32
690 V, gG, OFAA_GG_.....	33
690 V, gG, OFAA_H_, OFAA_H_-H20.....	34
aM-types	
500 V, aM, OFAF_AM_.....	35
690 V, aM, OFAM_AM_, OFAM_AM_-H20.....	36
690 V, aM, OFAA_AM_.....	37
Dimension drawings	38-39
Fuse monitor, connecting digram	39
Index	40-43



Fuse links - Safety, reliability and economy

DIN-type HRC-fuse link range

2...1600 A, 500 V and 690 V

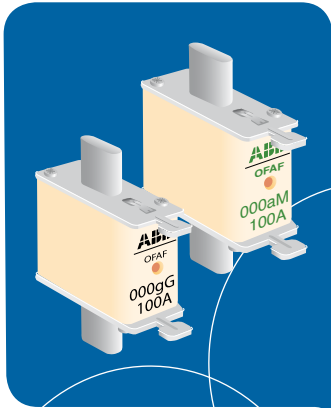

ABB's gG fuse links have proven themselves to be suitable for a number of applications, from over-current and short-circuit protection of lines to short-circuit protection of semiconductor and other equipment as well as protection of DC circuits. For motor protection, we recommend to use aM fuse links. The aM fuse links give economical and reliable protection. ABB fuse links for demanding industrial environments are available to be used in the protection of general as well as motor applications.

Superior current limiting capability

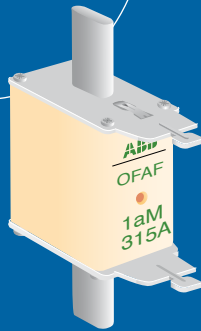

The fuse links limit the unlimited prospective short circuit current to cut-off current. When the low operating energy and cut-off current given in this brochure are used, cables and equipment can be specified without over-dimensioning. For example in the range of low short circuit, the low peak let-through energy protects the overload relay from burning, while during a short circuit the extremely fast operating fuse link protects the contactor contacts from welding and reduces the short-circuit forces in lines and equipment.

Dual indication of blown fuse

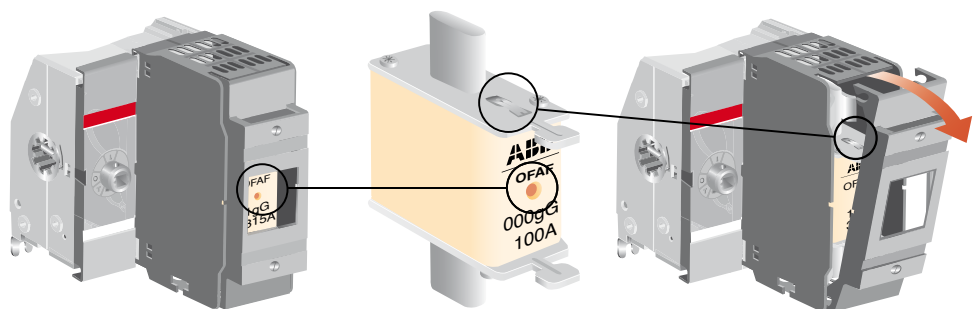
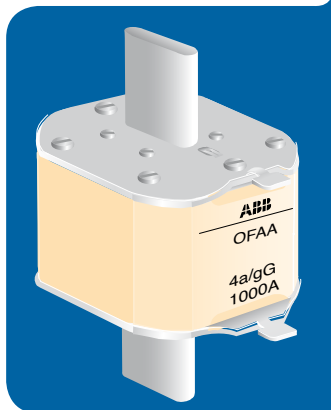

The dual indicating DIN-type fuse links incorporate the top and center indication system and are available for most common sizes up to 630 A. The center indicator and the wide windows on the front cover of ABB switch fuses enhance the service speed and safety level.

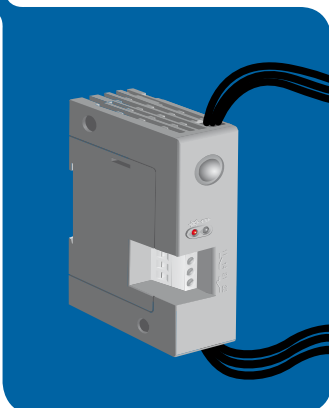

- ◀ The optional electronic fuse monitor enhances the protection and control of the circuitry. The fuse monitor provides status indications and control impulses in case of operated fuse link. The fuse helps protect three-phase motors for single-phase operation.

New fuse links

The perfect fit for the OS-switch fuses and fuse monitors minimize the need for space in the switchboard.

- ▶ The DIN 0 size fuse link saves space together with the OS-switch fuse.
- ▶ The new size 5 fuse links are developed to widen the

scope of main switch and motor protection switch fuses. Use the switch fuse size OS1250 and size 5 fuse links to achieve a motor rating of 1000 kW by 690 V .

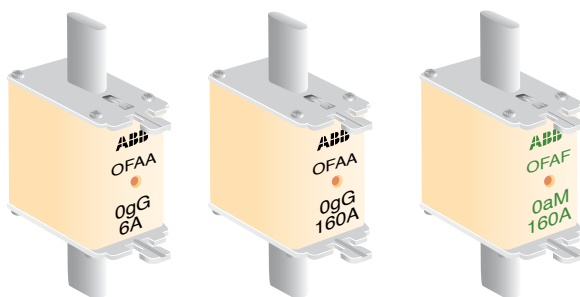

▲ The DIN 0 size fuse links for current range 6...250 A

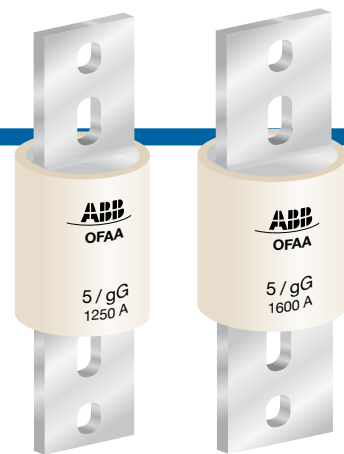

▲ The DIN 5 size fuse links up to 1600 A

Discrimination

Discrimination, (i.e. selectivity), is one of the most important features of the fuse links contributing to the reliability and availability of an electrical network. In case of a fault, only the affected part of the network is isolated. At the same time, the system is able to allow normal currents in the rest of the network

ABB fuse links are, in most cases, selective for consecutive fuses in the ratio of 1:1.6. In some cases the same range of ABB fuses are selective with a ratio up to 1:1.25.

Reliable protection

ABB fuse links guarantee maximum protection against all faults. The higher the voltage, the better the protection that can be achieved with the fuse link. The fused system provides, according to IEC 60947-4-1, type 2 coordination class up to 690 V, in which the equipment needs to be

operational even after a short circuit. The fast operation contributes to economical protection for semiconductors.

The oversize fuse links allow flexibility in the short-circuit protection of distribution and motor circuits, which enables the optimal use of fuse switches.



HRC Fuse links, DIN-type

Technical data

Standards:

- ▶ EN/IEC 60269-1-2, DIN
- ▶ VDE 0636, DIN 43620
- ▶ SFS 6000-8-801 (801.473.2) /2000
- ▶ SFS 6000-801/2007

Approvals:

- ▶ Lloyd's Register of Shipping
- ▶ DNV
- ▶ BV

RoHs certificate:

All fuse links are environment friendly and fulfill the requirements by RoHs.

Technical data according to EN/IEC 60269

The fuse links are tested to the following short circuit ratings:

Size			000	00	0	1	2	3	4
Max. current rating, AC	500 V	A	100	160	250	355	500	800	1250
	690 V	A	80	125	160	250	355	500	1000
Max. current rating, DC, time constant <20 ms	250 V	A	100	160			500	800	
	400 V	A			200	250	355	400	1250
	440 V	A				160	160		1000

Size			000...3	4	5
Breaking capacity, AC	500 V	kA	120	120	
	690 V	kA	80	160	160
Breaking capacity, DC	250 V	kA	40		
	400 V	kA	80	80	
	440 V	kA	80	80	80

Applications:

- ▶ gG- fuse links for general installation and industrial applications
 - ▶ 500 V / 690 V, OFAF_H_ / OFAA_GG_
 - Low power loss
 - Dual indication up to 630 A
 - ▶ 690 V, OFAA_H_ ja OFAA_H_-H20
 - for industrial applications, see coordination tables:
www.abb.com/Low Voltage products/Software tools/Coordination tables for motor protection
 - H20 -types for demanding industrial applications, silver coating 20µm
- ▶ aM-fuse links for motor protection
 - ▶ 500 V / 690 V, OFAF_AM_ / OFAA_AM_
 - Low power loss
 - Dual indication up to 630 A
 - ▶ 690 V, OFAM_AM_
 - Optimum dimensioning 400 V..690 V for motor protection in industrial applications, see coordination tables:
www.abb.com/Low Voltage products/Software tools/Coordination tables for motor protection
 - H20 -types for demanding industrial applications, silver coating 20µm

HRC fuse links, gG, universal fuses OFAF_H_, ≤ 500 V

The type code includes one fuse link, the delivery batch is according to the column. Dual indication.

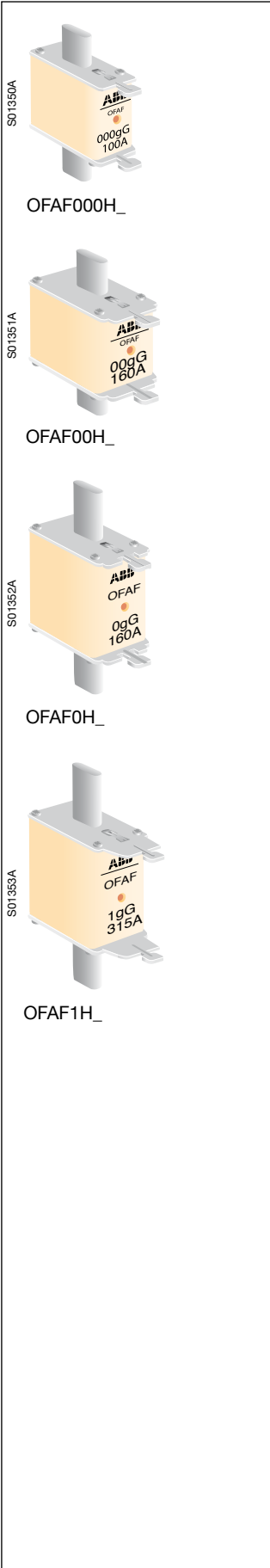

IEC-size	Rated current I _n [A]	Power loss P _h [W]	Type	Order number	Delivery batch [pcs]	Weight/
						unit [kg]
000	2	3.9	OFAF000H2	1SCA022627R0230	9	0.12
	4	1.5	OFAF000H4	1SCA022627R0310	9	0.12
	6	1.6	OFAF000H6	1SCA022627R0400	9	0.12
	10	1.1	OFAF000H10	1SCA022627R0580	9	0.12
	16	1.8	OFAF000H16	1SCA022627R0660	9	0.12
	20	2.4	OFAF000H20	1SCA022627R0740	9	0.12
	25	2.4	OFAF000H25	1SCA022627R0820	9	0.12
	32	2.7	OFAF000H32	1SCA022627R0910	9	0.12
	35	3.0	OFAF000H35	1SCA022627R1040	9	0.12
	40	3.4	OFAF000H40	1SCA022627R1120	9	0.12
	50	3.9	OFAF000H50	1SCA022627R1210	9	0.12
	63	4.7	OFAF000H63	1SCA022627R1390	9	0.12
	80	5.7	OFAF000H80	1SCA022627R1470	9	0.12
	100	6.7	OFAF000H100	1SCA022627R1550	9	0.12
00	125	8.4	OFAF00H125	1SCA022627R1630	3	0.18
	160	10.6	OFAF00H160	1SCA022627R1710	3	0.18
0	6	1.8	OFAF0H6	1SCA022627R1800	3	0.21
	10	1.5	OFAF0H10	1SCA022627R1980	3	0.21
	16	2.5	OFAF0H16	1SCA022627R2010	3	0.21
	20	3.5	OFAF0H20	1SCA022627R2100	3	0.21
	25	3.5	OFAF0H25	1SCA022627R2280	3	0.21
	32	3.2	OFAF0H32	1SCA022627R2360	3	0.21
	35	3.5	OFAF0H35	1SCA022627R2440	3	0.21
	40	4.2	OFAF0H40	1SCA022627R2520	3	0.21
	50	5.1	OFAF0H50	1SCA022627R2610	3	0.21
	63	6.2	OFAF0H63	1SCA022627R2790	3	0.21
	80	7.1	OFAF0H80	1SCA022627R2870	3	0.21
	100	8.7	OFAF0H100	1SCA022627R2950	3	0.21
	125	11.0	OFAF0H125	1SCA022627R3090	3	0.21
	160	11.7	OFAF0H160	1SCA022627R3170	3	0.21
	200	15.0	OFAF0H200	1SCA022629R5140	3	0.30
0	224	16.2	OFAF0H224	1SCA022629R5220	3	0.30
	250	17.8	OFAF0H250	1SCA022629R5310	3	0.30
1	16	2.5	OFAF1H16	1SCA022627R3250	3	0.28
	20	3.5	OFAF1H20	1SCA022627R3330	3	0.28
	25	3.3	OFAF1H25	1SCA022627R3410	3	0.28
	32	3.2	OFAF1H32	1SCA022627R3500	3	0.28
	35	3.5	OFAF1H35	1SCA022627R3680	3	0.28
	40	4.2	OFAF1H40	1SCA022627R3760	3	0.28
	50	5.1	OFAF1H50	1SCA022627R3840	3	0.28
	63	6.2	OFAF1H63	1SCA022627R3920	3	0.28
	80	7.1	OFAF1H80	1SCA022627R4060	3	0.28
	100	8.7	OFAF1H100	1SCA022627R4140	3	0.28
	125	11.0	OFAF1H125	1SCA022627R4220	3	0.40
	160	11.7	OFAF1H160	1SCA022627R4310	3	0.40
	200	14.5	OFAF1H200	1SCA022627R4490	3	0.40
	224	15.9	OFAF1H224	1SCA022627R4570	3	0.40
	250	19.7	OFAF1H250	1SCA022627R4650	3	0.40
	315	26.0	OFAF1H315	1SCA022627R4730	3	0.40
	355	26.4	OFAF1H355	1SCA022701R4520	3	0.40



HRC Fuse links, DIN-type, gG

Ordering information

HRC fuse links, gG, universal fuses OFAF_H_, ≤ 500V

The type code includes one fuse link, the delivery batch is according to the column.
Dual indication on fuse link sizes 2 and 3 up to 630 A.

IEC-size	Rated current I _n [A]	Power loss P _n [W]	Type	Order number	Delivery-batch [pcs]	Weight/unit [kg]
2	25	3.3	OFAF2H25	1SCA115948R1001	3	0.42
	35	3.5	OFAF2H35	1SCA022627R4810	3	0.42
	40	5.1	OFAF2H40	1SCA022627R4900	3	0.42
	50	6.0	OFAF2H50	1SCA022627R5030	3	0.42
	63	7.1	OFAF2H63	1SCA022627R5110	3	0.42
	80	8.6	OFAF2H80	1SCA022627R5200	3	0.42
	100	10.6	OFAF2H100	1SCA022627R5380	3	0.42
	125	11.9	OFAF2H125	1SCA022627R5460	3	0.42
	160	14.0	OFAF2H160	1SCA022627R5540	3	0.42
	200	15.4	OFAF2H200	1SCA022627R5620	3	0.42
	224	19.1	OFAF2H224	1SCA022627R5710	3	0.42
	250	22.5	OFAF2H250	1SCA022627R5890	3	0.42
	300	24.0	OFAF2H300	1SCA022627R5970	3	0.63
	315	26.2	OFAF2H315	1SCA022627R6010	3	0.63
	355	27.5	OFAF2H355	1SCA022627R6190	3	0.63
	400	30.2	OFAF2H400	1SCA022627R6270	3	0.63
425	33.0	OFAF2H425	1SCA022706R3900	3	0.63	
500	44.0	OFAF2H500	1SCA022701R4610	3	0.63	
3	250	17.9	OFAF3H250	1SCA022627R6350	1	0.63
	300	20.0	OFAF3H300	1SCA022627R6430	1	0.63
	315	22.4	OFAF3H315	1SCA022627R6510	1	0.63
	355	23.5	OFAF3H355	1SCA022627R6600	1	0.63
	400	30.1	OFAF3H400	1SCA022627R6780	1	0.63
	425	33.0	OFAF3H425	1SCA022627R6860	1	1.00
	450	36.0	OFAF3H450	1SCA022627R6940	1	1.00
	500	44.0	OFAF3H500	1SCA022627R7080	1	1.00
	630	47.5	OFAF3H630	1SCA022627R7160	1	1.00
	800	56.9	OFAF3H800	1SCA022627R7240	1	0.90
4	400	31.0	OFAF4H400	1SCA022627R7320	1	2.00
	500	35.0	OFAF4H500	1SCA022627R7410	1	2.00
	630	44.0	OFAF4H630	1SCA022627R7590	1	2.00
	800	70.0	OFAF4H800	1SCA022627R7670	1	2.00
	1000	85.0	OFAF4H1000	1SCA022627R7750	1	2.00
	1250	93.0	OFAF4H1250	1SCA022627R7830	1	2.00
4a	500	33.0	OFAF4AH500	1SCA022637R3980	1	2.00
	630	43.0	OFAF4AH630	1SCA022637R4010	1	2.00
	800	58.0	OFAF4AH800	1SCA022637R4100	1	2.00
	1000	71.0	OFAF4AH1000	1SCA022637R4280	1	2.00
	1250	85.0	OFAF4AH1250	1SCA022637R4360	1	2.00
5	1250 ¹⁾	78	OFAA5GG1250	1SCA112680R1001	1	3.20
	1600 ¹⁾	111	OFAA5GG1600	1SCA112681R1001	1	4.20

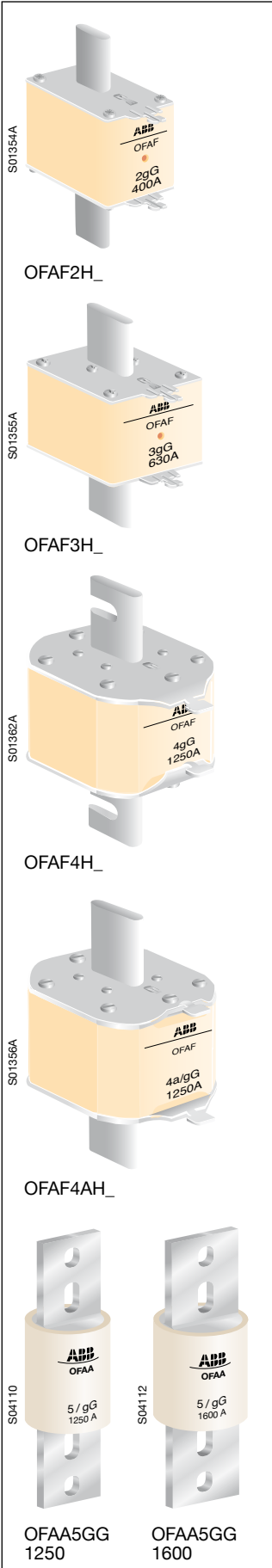

¹⁾ U_n 690 V

HRC fuse links, gG, universal fuses OFAA_GG_, ≤ 690V

The type code includes one fuse link, the delivery batch is according to the column. Dual indication.

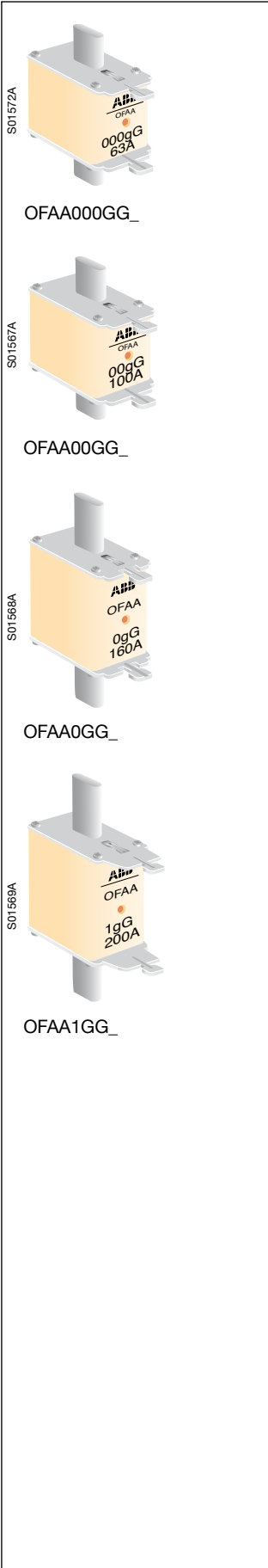

IEC-size	Rated current I_n [A]	Power loss P_h [W]	Type	Order number	Delivery- batch [pcs]	Weight/ unit [kg]
000	2	3.9	OFAA000GG2	1SCA022661R8250	9	0.12
	4	1.5	OFAA000GG4	1SCA022661R8330	9	0.12
	6	1.6	OFAA000GG6	1SCA022661R8410	9	0.12
	10	1.1	OFAA000GG10	1SCA022661R8500	9	0.12
	16	1.8	OFAA000GG16	1SCA022661R8680	9	0.12
	20	2.4	OFAA000GG20	1SCA022661R8760	9	0.12
	25	2.4	OFAA000GG25	1SCA022661R8840	9	0.12
	32	2.7	OFAA000GG32	1SCA022661R8920	9	0.12
	35	3.0	OFAA000GG35	1SCA022661R9060	9	0.12
	40	3.4	OFAA000GG40	1SCA022661R9140	9	0.12
	50	3.9	OFAA000GG50	1SCA022661R9220	9	0.12
	63	4.7	OFAA000GG63	1SCA022661R9310	9	0.12
	00	80	5.7	OFAA00GG80	1SCA022700R9440	3
100		6.7	OFAA00GG100	1SCA022700R9520	3	0.18
125		8.4	OFAA00GG125	1SCA022724R0610	3	0.18
0	6	1.8	OFAA0GG6	1SCA022703R1290	3	0.21
	10	1.5	OFAA0GG10	1SCA022703R1370	3	0.21
	16	2.5	OFAA0GG16	1SCA022703R1450	3	0.21
	20	3.5	OFAA0GG20	1SCA022703R1530	3	0.21
	25	3.5	OFAA0GG25	1SCA022703R1610	3	0.21
	32	3.2	OFAA0GG32	1SCA022703R1700	3	0.21
	35	3.5	OFAA0GG35	1SCA022703R1880	3	0.21
	40	4.2	OFAA0GG40	1SCA022703R1960	3	0.21
	50	5.1	OFAA0GG50	1SCA022703R2000	3	0.21
	63	6.2	OFAA0GG63	1SCA022703R2180	3	0.21
	80	7.1	OFAA0GG80	1SCA022703R2260	3	0.21
	100	8.7	OFAA0GG100	1SCA022703R2340	3	0.21
	125	11.0	OFAA0GG125	1SCA022703R2420	3	0.21
	160	11.7	OFAA0GG160	1SCA022703R2510	3	0.21
	1	16	2.5	OFAA1GG16	1SCA022703R2690	3
20		3.5	OFAA1GG20	1SCA022703R2770	3	0.28
25		3.3	OFAA1GG25	1SCA022703R2850	3	0.28
32		3.2	OFAA1GG32	1SCA022703R2930	3	0.28
35		3.5	OFAA1GG35	1SCA022703R3070	3	0.28
40		4.2	OFAA1GG40	1SCA022703R3150	3	0.28
50		5.1	OFAA1GG50	1SCA022700R9610	3	0.28
63		6.2	OFAA1GG63	1SCA022700R9790	3	0.28
80		7.1	OFAA1GG80	1SCA022700R9870	3	0.28
100		8.7	OFAA1GG100	1SCA022700R9950	3	0.28
125		11.0	OFAA1GG125	1SCA022701R0020	3	0.40
160		11.7	OFAA1GG160	1SCA022701R0110	3	0.40
200		14.5	OFAA1GG200	1SCA022701R0290	3	0.40
250	17.8	OFAA1GG250	1SCA022701R0370	3	0.40	



HRC Fuse links, DIN-type, gG Ordering information

HRC fuse links, gG, universal fuses OFAA_GG_, ≤ 690V

The type code includes one fuse link, the delivery batch is according to the column.
Dual indication on fuse link sizes 2 and 3.

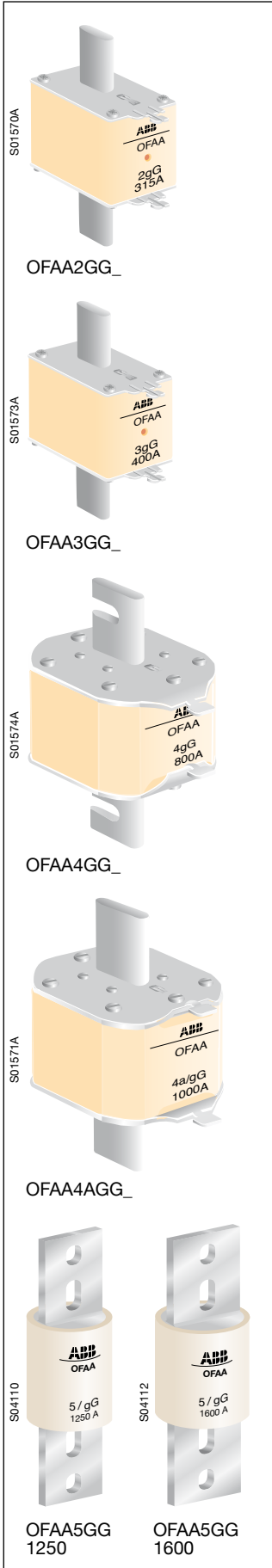

IEC-size	Rated current I_n [A]	Power loss P_n [W]	Type	Order number	Delivery-batch [pcs]	Weight/ unit [kg]
2	32	3.2	OFAA2GG32	1SCA022703R3230	3	0.42
	35	3.5	OFAA2GG35	1SCA022703R3310	3	0.42
	40	5.1	OFAA2GG40	1SCA022703R3400	3	0.42
	50	6.0	OFAA2GG50	1SCA022703R3580	3	0.42
	63	7.1	OFAA2GG63	1SCA022703R3660	3	0.42
	80	8.6	OFAA2GG80	1SCA022703R3740	3	0.42
	100	10.6	OFAA2GG100	1SCA022703R3820	3	0.42
	125	11.9	OFAA2GG125	1SCA022701R0450	3	0.42
	160	14.0	OFAA2GG160	1SCA022701R0530	3	0.42
	200	15.4	OFAA2GG200	1SCA022701R0610	3	0.42
	224	19.1	OFAA2GG224	1SCA022703R3910	3	0.42
	250	22.5	OFAA2GG250	1SCA022701R0700	3	0.42
	300	24.0	OFAA2GG300	1SCA022703R4040	3	0.63
	315	26.2	OFAA2GG315	1SCA022701R0880	3	0.63
	355	27.0	OFAA2GG355	1SCA022701R0960	3	0.63
3	250	17.9	OFAA3GG250	1SCA022703R4120	1	0.63
	300	21.0	OFAA3GG300	1SCA022703R4210	1	0.63
	315	22.4	OFAA3GG315	1SCA022701R1000	1	0.63
	355	23.5	OFAA3GG355	1SCA022701R1180	1	0.63
	400	30.1	OFAA3GG400	1SCA022701R1260	1	0.63
	425	33.0	OFAA3GG425	1SCA022706R4030	1	1.00
	500	44.0	OFAA3GG500	1SCA022701R1340	1	1.00
4	500	35.0	OFAA4GG500	1SCA022701R1420	1	2.00
	630	44.0	OFAA4GG630	1SCA022701R1510	1	2.00
	800	70.0	OFAA4GG800	1SCA022701R1690	1	2.00
	1000	85.0	OFAA4GG1000	1SCA112679R1001	1	2.00
4a	500	33.0	OFAA4AGG500	1SCA022660R9770	1	2.00
	630	43.0	OFAA4AGG630	1SCA022660R9850	1	2.00
	800	58.0	OFAA4AGG800	1SCA022660R9930	1	2.00
	1000	71.0	OFAA4AGG1000	1SCA022699R6360	1	2.00
5	1250	78	OFAA5GG1250	1SCA112680R1001	1	3.20
	1600	111	OFAA5GG1600	1SCA112681R1001	1	4.20

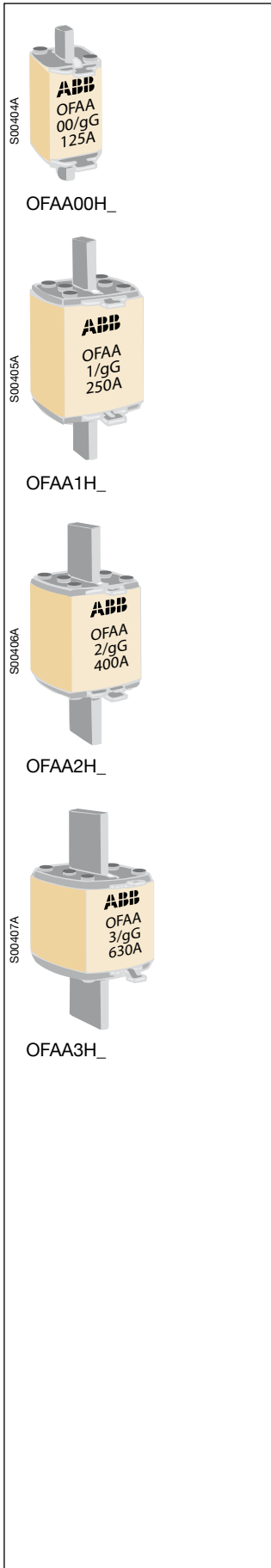

HRC fuse links, gG, universal fuses OFAA_H_, 690V

The type code includes one fuse link, the delivery batch is according to the column. Indication on the top of fuse link.

IEC-size	Rated current I _n [A]	Rated voltage U _n [V]	Power loss P _h [W]	Type	Order number	Delivery-batch [pcs]	Weight/unit [kg]
00	2	690	1.3	OFAA00H2	1SCA022041R3630	30	0.16
	4	690	1.4	OFAA00H4	1SCA022028R5700	30	0.16
	6	690	1.4	OFAA00H6	1SCA022007R3940	30	0.16
	10	690	2.7	OFAA00H10	1SCA022007R4080	30	0.16
	16	690	3	OFAA00H16	1SCA022007R4160	30	0.16
	20	690	3.2	OFAA00H20	1SCA022007R4240	30	0.16
	25	690	3.9	OFAA00H25	1SCA022007R4320	30	0.16
	32	690	4.5	OFAA00H32	1SCA022208R7050	30	0.16
	35	690	4.9	OFAA00H35	1SCA022007R4410	30	0.16
	40	690	5.3	OFAA00H40	1SCA022261R7200	30	0.16
	50	690	6.9	OFAA00H50	1SCA022007R4590	30	0.16
	63	690	8.6	OFAA00H63	1SCA022007R4670	30	0.16
	80	690	9.2	OFAA00H80	1SCA022007R4750	30	0.16
	100	690	9.6	OFAA00H100	1SCA022007R4830	30	0.16
125	500	10.6	OFAA00H125	1SCA022078R4290	30	0.16	
1	16	690	1.9	OFAA1H16	1SCA022023R9510	3	0.49
	20	690	3.1	OFAA1H20	1SCA022023R9690	3	0.49
	25	690	3.9	OFAA1H25	1SCA022023R9770	3	0.49
	32	690	4.6	OFAA1H32	1SCA022197R1420	3	0.49
	35	690	5	OFAA1H35	1SCA022007R4910	3	0.49
	40	690	6.3	OFAA1H40	1SCA022197R1690	3	0.49
	50	690	7.1	OFAA1H50	1SCA022007R5050	3	0.49
	63	690	8.5	OFAA1H63	1SCA022007R5130	3	0.49
	80	690	9.4	OFAA1H80	1SCA022007R5210	3	0.49
	100	690	14	OFAA1H100	1SCA022007R5300	3	0.49
	125	690	19	OFAA1H125	1SCA022007R5480	3	0.49
	160	690	20	OFAA1H160	1SCA022007R5560	3	0.49
	200	690	22.5	OFAA1H200	1SCA022007R5640	3	0.49
	250	500	23	OFAA1H250	1SCA022007R5720	3	0.49
2	160	690	21	OFAA2H160	1SCA022007R5810	3	0.67
	200	690	23	OFAA2H200	1SCA022007R5990	3	0.67
	250	690	25.5	OFAA2H250	1SCA022007R6020	3	0.67
	315	690	31.5	OFAA2H315	1SCA022007R6110	3	0.67
	400	500	34	OFAA2H400	1SCA022007R6290	3	0.67
3	315	690	30.5	OFAA3H315	1SCA022007R6370	3	0.97
	400	690	41.5	OFAA3H400	1SCA022007R6450	3	0.97
	500	690	45	OFAA3H500	1SCA022007R6530	3	0.97
	630	500	48	OFAA3H630	1SCA022007R6610	3	0.97

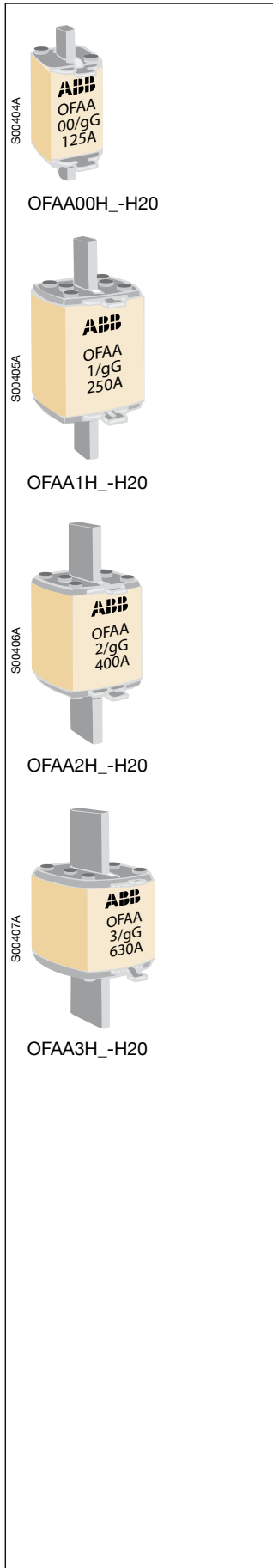

HRC fuse links, gG, OFAA_H_-H20, industrial fuses, 690V

Industrial fuses with 20 µm silver coating for demanding industrial environment.
The type code includes one fuse link, the delivery batch is according to the column.
Indication on the top of fuse link.

IEC-size	Rated current I_n [A]	Rated voltage U_n [V]	Power loss P_h [W]	Type	Order number	Delivery-batch [pcs]	Weight/unit [kg]
00	2	690	1.3	OFAA00H2-H20	1SCA022297R0150	3	0.16
	4	690	1.4	OFAA00H4-H20	1SCA022297R1120	3	0.16
	6	690	1.4	OFAA00H6-H20	1SCA022297R1710	3	0.16
	10	690	2.7	OFAA00H10-H20	1SCA022296R9310	3	0.16
	16	690	3	OFAA00H16-H20	1SCA022296R9900	3	0.16
	20	690	3.2	OFAA00H20-H20	1SCA022297R0310	3	0.16
	25	690	3.9	OFAA00H25-H20	1SCA022297R0580	3	0.16
	32	690	4.5	OFAA00H32-H20	1SCA022297R0740	3	0.16
	35	690	4.9	OFAA00H35-H20	1SCA022297R0910	3	0.16
	40	690	5.3	OFAA00H40-H20	1SCA022297R1390	3	0.16
	50	690	6.9	OFAA00H50-H20	1SCA022297R1550	3	0.16
	63	690	8.6	OFAA00H63-H20	1SCA022297R1980	3	0.16
	80	690	9.2	OFAA00H80-H20	1SCA022297R2100	3	0.16
	100	690	9.6	OFAA00H100-H20	1SCA022296R9570	3	0.16
125	500	10.6	OFAA00H125-H20	1SCA022296R9730	3	0.16	
1	16	690	1.9	OFAA1H16-H20	1SCA022297R2950	3	0.49
	20	690	3.1	OFAA1H20-H20	1SCA022297R3330	3	0.49
	25	690	3.9	OFAA1H25-H20	1SCA022297R3760	3	0.49
	32	690	4.6	OFAA1H32-H20	1SCA022297R4140	3	0.49
	35	690	5	OFAA1H35-H20	1SCA022297R4310	3	0.49
	40	690	6.3	OFAA1H40-H20	1SCA022297R4570	3	0.49
	50	690	7.1	OFAA1H50-H20	1SCA022297R4730	3	0.49
	63	690	8.5	OFAA1H63-H20	1SCA022299R4410	3	0.49
	80	690	9.4	OFAA1H80-H20	1SCA022299R4680	3	0.49
	100	690	14	OFAA1H100-H20	1SCA022297R2520	3	0.49
	125	690	19	OFAA1H125-H20	1SCA022297R2790	3	0.49
	160	690	20	OFAA1H160-H20	1SCA022297R3170	3	0.49
	200	690	22.5	OFAA1H200-H20	1SCA022297R3500	3	0.49
	250	500	23	OFAA1H250-H20	1SCA022297R3920	3	0.49
2	160	690	21	OFAA2H160-H20	1SCA022299R4840	3	0.67
	200	690	23	OFAA2H200-H20	1SCA022299R5060	3	0.67
	250	690	25.5	OFAA2H250-H20	1SCA022299R5220	3	0.67
	315	690	31.5	OFAA2H315-H20	1SCA022299R5490	3	0.67
	400	500	34	OFAA2H400-H20	1SCA022299R5650	3	0.67
3	315	690	30.5	OFAA3H315-H20	1SCA022299R5810	3	0.97
	400	690	41.5	OFAA3H400-H20	1SCA022299R6030	3	0.97
	500	690	45	OFAA3H500-H20	1SCA022299R6200	3	0.97
	630	500	48	OFAA3H630-H20	1SCA022299R6460	3	0.97



HRC Fuse links, DIN-type, aM

Ordering information

HRC fuse links for motor protection, aM, OFAF_AM_, 500V

The type code includes one fuse link, the delivery batch is according to the column.
Dual indication.

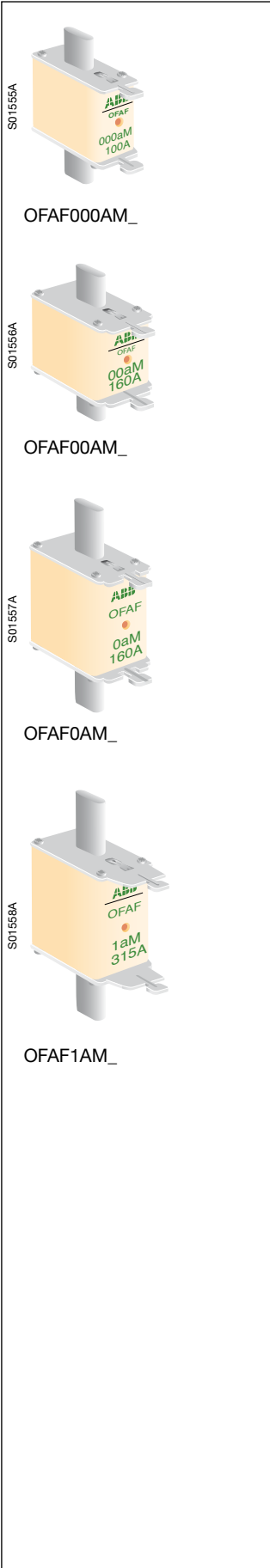

IEC-size	Rated current I_n [A]	Power loss P_h [W]	Type	Order number	Delivery- batch [pcs]	Weight/ unit [kg]	
000	2	0.1	OFAF000AM2	1SCA022652R0360	9	0.12	
	4	0.2	OFAF000AM4	1SCA022652R0440	9	0.12	
	6	0.3	OFAF000AM6	1SCA022652R0520	9	0.12	
	10	0.5	OFAF000AM10	1SCA022652R0610	9	0.12	
	16	0.7	OFAF000AM16	1SCA022652R0790	9	0.12	
	20	0.9	OFAF000AM20	1SCA022652R0870	9	0.12	
	25	1.2	OFAF000AM25	1SCA022652R0950	9	0.12	
	32	1.5	OFAF000AM32	1SCA022652R1090	9	0.12	
	35	1.6	OFAF000AM35	1SCA022697R2510	9	0.12	
	40	1.8	OFAF000AM40	1SCA022652R1170	9	0.12	
	50	2.3	OFAF000AM50	1SCA022697R2690	9	0.12	
	63	2.9	OFAF000AM63	1SCA022697R2770	9	0.12	
	80	3.6	OFAF000AM80	1SCA022697R2850	9	0.12	
	00	100	5.2	OFAF00AM100	1SCA022697R2930	3	0.18
		125	6.4	OFAF00AM125	1SCA022697R3070	3	0.18
		160	7.9	OFAF00AM160	1SCA022697R3150	3	0.18
0	6	0.3	OFAF0AM6	1SCA022697R3230	3	0.21	
	10	0.5	OFAF0AM10	1SCA022697R3310	3	0.21	
	16	0.8	OFAF0AM16	1SCA022697R3400	3	0.21	
	20	1.0	OFAF0AM20	1SCA022697R3580	3	0.21	
	25	1.3	OFAF0AM25	1SCA022697R3660	3	0.21	
	32	1.6	OFAF0AM32	1SCA022697R3740	3	0.21	
	35	1.7	OFAF0AM35	1SCA022697R3820	3	0.21	
	40	2.0	OFAF0AM40	1SCA022697R3910	3	0.21	
	50	2.8	OFAF0AM50	1SCA022697R4040	3	0.21	
	63	3.4	OFAF0AM63	1SCA022697R5610	3	0.21	
	80	4.9	OFAF0AM80	1SCA022697R5950	3	0.21	
	100	6.0	OFAF0AM100	1SCA022697R5790	3	0.21	
	125	7.9	OFAF0AM125	1SCA022697R6090	3	0.21	
	160	10.5	OFAF0AM160	1SCA022697R6170	3	0.21	
200	11.8	OFAF0AM200	1SCA022697R6250	3	0.21		
1	16	1.0	OFAF1AM16	1SCA022697R6330	3	0.28	
	20	1.2	OFAF1AM20	1SCA022697R6410	3	0.28	
	25	1.4	OFAF1AM25	1SCA022697R6500	3	0.28	
	32	1.9	OFAF1AM32	1SCA022697R6680	3	0.28	
	35	2.0	OFAF1AM35	1SCA022697R6760	3	0.28	
	40	2.3	OFAF1AM40	1SCA022697R6840	3	0.28	
	50	2.9	OFAF1AM50	1SCA022697R6920	3	0.28	
	63	3.6	OFAF1AM63	1SCA022697R7060	3	0.28	
	80	4.6	OFAF1AM80	1SCA022697R7140	3	0.28	
	100	5.8	OFAF1AM100	1SCA022697R7220	3	0.28	
	160	10.4	OFAF1AM160	1SCA022697R7490	3	0.30	
	200	14.2	OFAF1AM200	1SCA022697R7570	3	0.30	
	224	16.0	OFAF1AM224	1SCA022697R7650	3	0.30	
	250	17.5	OFAF1AM250	1SCA022697R7730	3	0.30	
	315	22.1	OFAF1AM315	1SCA022697R7810	3	0.30	



HRC Fuse links, DIN-type, aM

Ordering information

HRC fuse links for motor protection, aM, OFAF_AM_, 500V

The type code includes one fuse link, the delivery batch is according to the column.
Dual indication on fuse link sizes 2 and 3 up to 630 A.

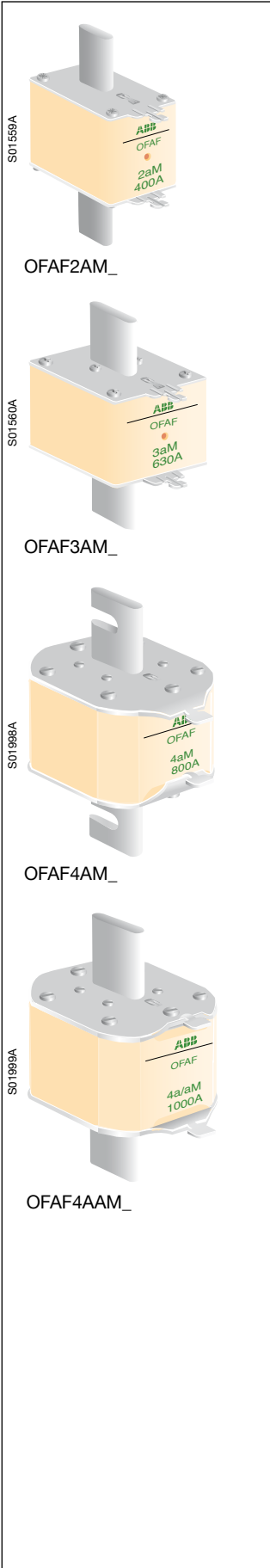

IEC-size	Rated current I _n [A]	Power loss P _n [W]	Type	Order number	Delivery-batch [pcs]	Weight/unit [kg]
2	35	1.8	OFAF2AM35	1SCA022697R8110	3	0.32
	40	2.1	OFAF2AM40	1SCA022697R8200	3	0.32
	50	2.7	OFAF2AM50	1SCA022697R8380	3	0.32
	63	3.4	OFAF2AM63	1SCA022697R8460	3	0.32
	80	4.4	OFAF2AM80	1SCA022697R8540	3	0.32
	100	5.5	OFAF2AM100	1SCA022697R8620	3	0.32
	125	6.4	OFAF2AM125	1SCA022697R8710	3	0.32
	160	9.3	OFAF2AM160	1SCA022697R8890	3	0.32
	200	11.3	OFAF2AM200	1SCA022697R8970	3	0.32
	224	16.0	OFAF2AM224	1SCA022697R9010	3	0.32
	250	16.8	OFAF2AM250	1SCA022697R9190	3	0.32
	300	21.0	OFAF2AM300	1SCA022697R9270	3	0.40
	315	23.1	OFAF2AM315	1SCA022697R9350	3	0.40
	355	26.0	OFAF2AM355	1SCA022697R9430	3	0.40
	400	29.7	OFAF2AM400	1SCA022697R9510	3	0.40
	500	34.4	OFAF2AM500	1SCA022697R9600	3	0.40
3	250	16.0	OFAF3AM250	1SCA022697R9780	1	0.45
	300	21.0	OFAF3AM300	1SCA022697R9860	1	0.45
	315	21.0	OFAF3AM315	1SCA022697R9940	1	0.45
	355	26.5	OFAF3AM355	1SCA022698R0010	1	0.45
	400	29.1	OFAF3AM400	1SCA022698R0100	1	0.45
	425	33.0	OFAF3AM425	1SCA022698R0280	1	0.60
	450	37.0	OFAF3AM450	1SCA022698R0360	1	0.60
	500	42.0	OFAF3AM500	1SCA022698R0440	1	0.60
	630	42.0	OFAF3AM630	1SCA022698R0520	1	0.60
	800 ¹⁾	55.0	OFAF3AM800	1SCA022701R4790	1	0.60
4	400	26.0	OFAF4AM400	1SCA022698R0610	1	2.00
	500	38.0	OFAF4AM500	1SCA022698R0790	1	2.00
	630	50.0	OFAF4AM630	1SCA022698R0870	1	2.00
	800	65.0	OFAF4AM800	1SCA022698R0950	1	2.00
	1000	80.0	OFAF4AM1000	1SCA022698R1090	1	2.00
	1250	110.0	OFAF4AM1250	1SCA022698R1170	1	2.00
4a	500	38.0	OFAF4AAM500	1SCA022698R1410	1	2.00
	630	50.0	OFAF4AAM630	1SCA022698R1680	1	2.00
	800	65.0	OFAF4AAM800	1SCA022698R1760	1	2.00
	1000	80.0	OFAF4AAM1000	1SCA022698R1840	1	2.00
	1250	110.0	OFAF4AAM1250	1SCA022698R1920	1	2.00

¹⁾ 800 A / 400 V

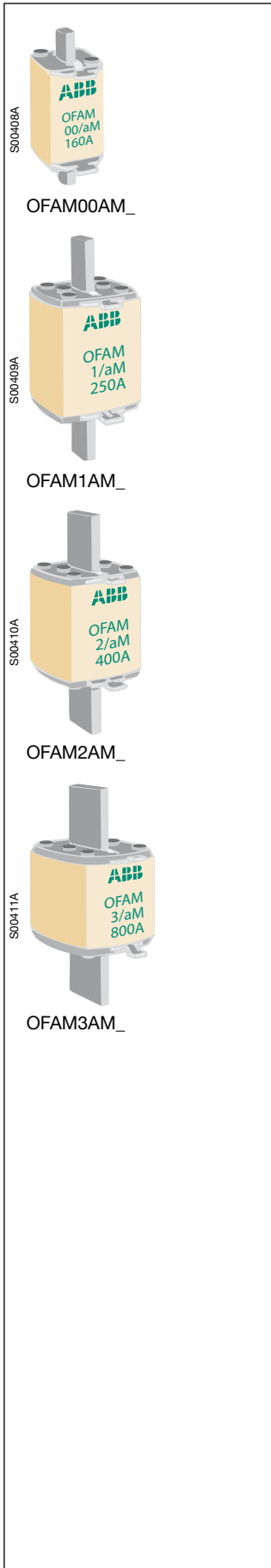

HRC fuse links for motor protection, aM, OFAM_AM_, 690V

The type code includes one fuse link, the delivery batch is according to the column. Indication on the top of fuse link. Coordination tables, see the [www](http://www.abb.com) -address, page 6.

IEC-size	Rated current I _n [A]	Rated voltage U _n [V]	Power loss P _h [W]	Type	Order number	Delivery-batch [pcs]	Weight/unit [kg]
00	2	690	0.17	OFAM00AM2	1SCA022640R4960	3	0.16
	4	690	0.35	OFAM00AM4	1SCA022386R2630	3	0.16
	6	690	0.4	OFAM00AM6	1SCA022386R2710	3	0.16
	10	690	0.72	OFAM00AM10	1SCA022386R2800	3	0.16
	16	690	1.1	OFAM00AM16	1SCA022323R6520	3	0.16
	20	690	1.4	OFAM00AM20	1SCA022323R6790	3	0.16
	25	690	1.6	OFAM00AM25	1SCA022324R2410	3	0.16
	32	690	2.1	OFAM00AM32	1SCA022324R2680	3	0.16
	40	690	2.9	OFAM00AM40	1SCA022324R2840	3	0.16
	50	690	3.7	OFAM00AM50	1SCA022324R2500	3	0.16
	63	690	4.6	OFAM00AM63	1SCA022324R2760	3	0.16
	80	690	6.4	OFAM00AM80	1SCA022324R2920	3	0.16
	100	690	7.7	OFAM00AM100	1SCA022324R8610	3	0.16
	125	690	9.1	OFAM00AM125	1SCA022324R8880	3	0.16
	160	690	12	OFAM00AM160	1SCA022324R9000	3	0.16
	1	50	690	2.9	OFAM1AM50	1SCA022194R7390	3
63		690	3.5	OFAM1AM63	1SCA022194R7120	3	0.49
80		690	4.7	OFAM1AM80	1SCA022194R6910	3	0.49
100		690	6	OFAM1AM100	1SCA022194R6740	3	0.49
125		690	7.1	OFAM1AM125	1SCA022194R6580	3	0.49
160		690	14.2	OFAM1AM160	1SCA022103R6100	3	0.49
200		690	17.7	OFAM1AM200	1SCA022103R6360	3	0.49
250		690	18.3	OFAM1AM250	1SCA022103R6520	3	0.49
2	125	690	9.3	OFAM2AM125	1SCA022194R6310	3	0.67
	160	690	9.8	OFAM2AM160	1SCA022194R6150	3	0.67
	200	690	12	OFAM2AM200	1SCA022194R5510	3	0.67
	250	690	16	OFAM2AM250	1SCA022194R5340	3	0.67
	315	690	25	OFAM2AM315	1SCA022103R0670	3	0.67
	355	690	26	OFAM2AM355	1SCA022103R0670	3	0.67
	400	690	30	OFAM2AM400	1SCA022103R0830	3	0.67
	3	315	690	21	OFAM3AM315	1SCA022194R4960	3
355		690	25	OFAM3AM355	1SCA022194R4700	3	0.97
400		690	29.2	OFAM3AM400	1SCA022194R4530	3	0.97
500		690	36	OFAM3AM500	1SCA022103R1050	3	0.97
630		690	40	OFAM3AM630	1SCA022103R1210	3	0.97
800		500	70	OFAM3AM800	1SCA022655R7360	3	0.97



HRC Fuse links, DIN-type, aM

Ordering information

HRC fuse links for motor protection, aM, OFAA_AM_, 690V

The type code includes one fuse link, the delivery batch is according to the column.
Dual indication on fuse link sizes from 000 up to 3.

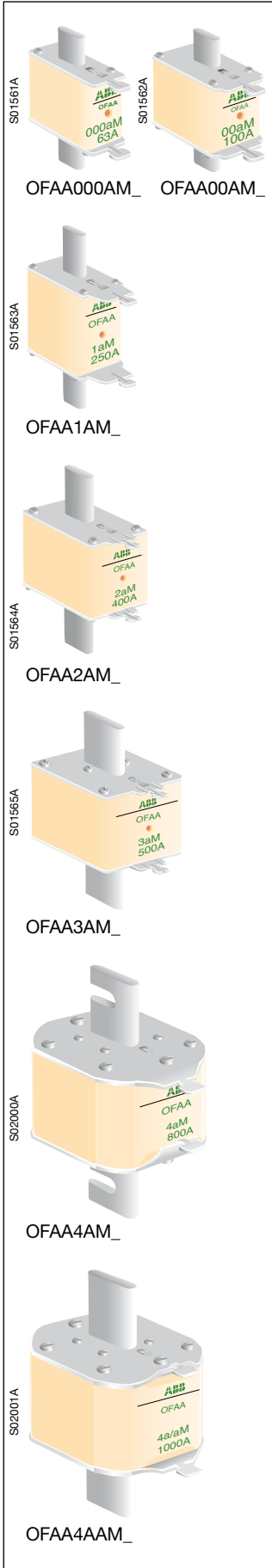

IEC-size	Rated current I_n [A]	Power loss P_n [W]	Type	Order number	Delivery-batch [pcs]	Weight/ unit [kg]
000	2	0.1	OFAA000AM2	1SCA022660R7640	9	0.12
	4	0.2	OFAA000AM4	1SCA022660R8020	9	0.12
	6	0.3	OFAA000AM6	1SCA022660R8110	9	0.12
	10	0.5	OFAA000AM10	1SCA022660R8290	9	0.12
	16	0.7	OFAA000AM16	1SCA022660R8370	9	0.12
	20	0.9	OFAA000AM20	1SCA022660R8450	9	0.12
	25	1.2	OFAA000AM25	1SCA022660R8530	9	0.12
	32	1.5	OFAA000AM32	1SCA022660R8610	9	0.12
	35	1.6	OFAA000AM35	1SCA022660R8700	9	0.12
	40	1.8	OFAA000AM40	1SCA022660R8880	9	0.12
	50	2.3	OFAA000AM50	1SCA022660R8960	9	0.12
	63	2.9	OFAA000AM63	1SCA022660R9000	9	0.12
00	80	3.6	OFAA00AM80	1SCA022701R1770	3	0.18
	100	5.2	OFAA00AM100	1SCA022701R1850	3	0.18
	125	7.5	OFAA00AM125	1SCA022701R1930	3	0.18
	160		OFAM00AM160	1SCA022324R9000	3	0.18
1	50	2.9	OFAA1AM50	1SCA022701R2070	3	0.28
	63	3.6	OFAA1AM63	1SCA022701R2150	3	0.28
	80	4.6	OFAA1AM80	1SCA022701R2230	3	0.28
	100	5.8	OFAA1AM100	1SCA022701R2310	3	0.28
	125	7.5	OFAA1AM125	1SCA022701R2400	3	0.30
	160	10.4	OFAA1AM160	1SCA022701R2580	3	0.30
	200	14.2	OFAA1AM200	1SCA022701R2660	3	0.30
	250	17.5	OFAA1AM250	1SCA022701R2740	3	0.30
2	125	6.4	OFAA2AM125	1SCA022701R2820	3	0.32
	160	9.3	OFAA2AM160	1SCA022701R2910	3	0.32
	200	11.3	OFAA2AM200	1SCA022701R3040	3	0.32
	250	16.8	OFAA2AM250	1SCA022701R3120	3	0.32
	315	23.1	OFAA2AM315	1SCA022701R3210	3	0.40
	355	25.0	OFAA2AM355	1SCA022701R3390	3	0.40
	400	29.7	OFAA2AM400	1SCA022701R3470	3	0.40
	3	315	21.0	OFAA3AM315	1SCA022701R3550	1
355		24.5	OFAA3AM355	1SCA022701R3630	1	0.45
400		29.1	OFAA3AM400	1SCA022701R3710	1	0.45
500		42.0	OFAA3AM500	1SCA022701R3800	1	0.60
4		500	38.0	OFAA4AM500	1SCA022701R3980	1
	630	50.0	OFAA4AM630	1SCA022701R4010	1	2.00
	800	65.0	OFAA4AM800	1SCA022701R4100	1	2.00
	1000	80.0	OFAA4AM1000	1SCA022776R1000	1	2.00
	4a	500	38.0	OFAA4AAM500	1SCA022701R4280	1
630		50.0	OFAA4AAM630	1SCA022701R4360	1	2.00
800		65.0	OFAA4AAM800	1SCA022701R4440	1	2.00
1000		80.0	OFAA4AAM1000	1SCA022703R4550	1	2.00



HRC Fuse links, DIN-type, aM

Ordering information

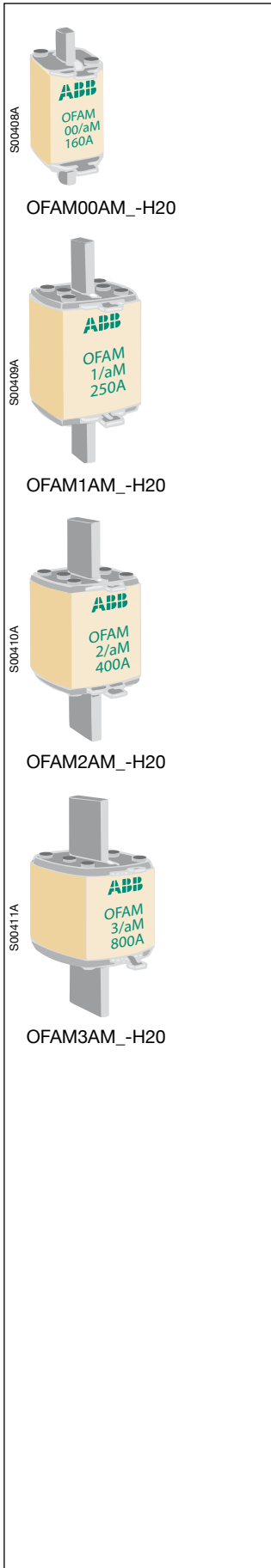

HRC fuse links for motor protection, aM, OFAM_AM_-H20, industrial fuses, 690V

Industrial fuses with 20 µm silver coating for demanding industrial environment.
The type code includes one fuse link, the delivery batch is according to the column.
Indication on the top of fuse link. Coordination tables, see the www -address, page 6.

IEC-size	Rated current I _n [A]	Rated voltage U _n [V]	Power loss P _h [W]	Type	Order number	Delivery-batch [pcs]	Weight/unit [kg]
00	2	690	0.17	OFAM00AM2-H20	1SCA022640R5000	3	0.16
	4	690	0.35	OFAM00AM4-H20	1SCA022386R7270	3	0.16
	6	690	0.4	OFAM00AM6-H20	1SCA022386R7350	3	0.16
	10	690	0.72	OFAM00AM10-H20	1SCA022386R7430	3	0.16
	16	690	1.1	OFAM00AM16-H20	1SCA022339R3460	3	0.16
	20	690	1.4	OFAM00AM20-H20	1SCA022339R3620	3	0.16
	25	690	1.6	OFAM00AM25-H20	1SCA022339R3890	3	0.16
	32	690	2.1	OFAM00AM32-H20	1SCA022339R4010	3	0.16
	40	690	2.9	OFAM00AM40-H20	1SCA022339R4270	3	0.16
	50	690	3.7	OFAM00AM50-H20	1SCA022339R4430	3	0.16
	63	690	4.6	OFAM00AM63-H20	1SCA022339R4600	3	0.16
	80	690	6.4	OFAM00AM80-H20	1SCA022339R4860	3	0.16
1	100	690	7.7	OFAM00AM100-H20	1SCA022339R5080	3	0.16
	125	690	9.1	OFAM00AM125-H20	1SCA022339R5240	3	0.16
	160	690	12	OFAM00AM160-H20	1SCA022339R5410	3	0.16
	50	690	2.9	OFAM1AM50-H20	1SCA022299R7600	3	0.49
	63	690	3.5	OFAM1AM63-H20	1SCA022299R7860	3	0.49
	80	690	4.7	OFAM1AM80-H20	1SCA022299R8080	3	0.49
	100	690	6	OFAM1AM100-H20	1SCA022299R6620	3	0.49
	125	690	7.1	OFAM1AM125-H20	1SCA022299R6890	3	0.49
	160	690	14.2	OFAM1AM160-H20	1SCA022299R7010	3	0.49
	200	690	17.7	OFAM1AM200-H20	1SCA022299R7270	3	0.49
	250	690	18.3	OFAM1AM250-H20	1SCA022299R7430	3	0.49
	2	125	690	9.3	OFAM2AM125-H20	1SCA022299R8240	3
160		690	9.8	OFAM2AM160-H20	1SCA022299R8410	3	0.67
200		690	12	OFAM2AM200-H20	1SCA022299R8670	3	0.67
250		690	16	OFAM2AM250-H20	1SCA022299R8830	3	0.67
315		690	25	OFAM2AM315-H20	1SCA022299R9050	3	0.67
355		690	26	OFAM2AM355-H20	1SCA022299R9210	3	0.67
400		690	30	OFAM2AM400-H20	1SCA022299R9480	3	0.67
3	315	690	21	OFAM3AM315-H20	1SCA022299R3520	3	0.97
	355	690	25	OFAM3AM355-H20	1SCA022299R3790	3	0.97
	400	690	29.2	OFAM3AM400-H20	1SCA022299R3950	3	0.97
	500	690	36	OFAM3AM500-H20	1SCA022299R4170	3	0.97
	630	690	40	OFAM3AM630-H20	1SCA022299R4330	3	0.97
	800	500	70	OFAM3AM800-H20	1SCA022655R7440	3	0.97

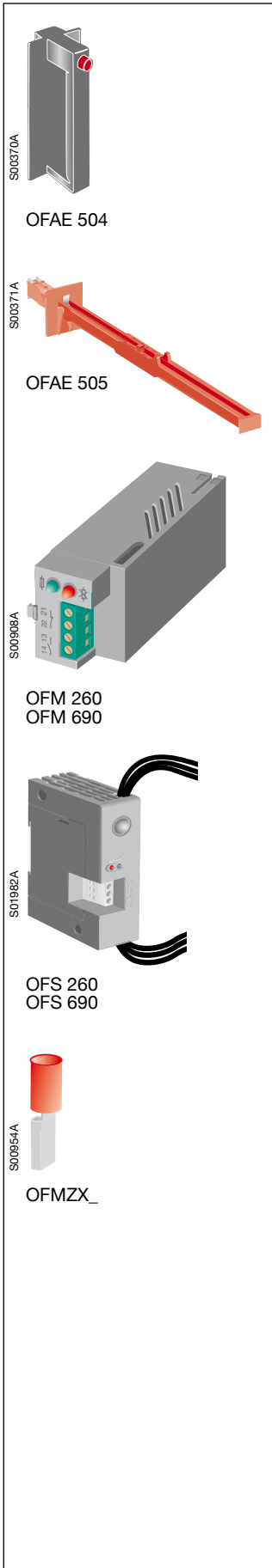

Fuse replacement handles

REMARK: Fuse size 4a, fuse replacement with the cover of switch fuse OS1250 or fuse base OFAX4.

Suitable for DIN-fuse link size	Description	Type	Order number	Units/type [pcs]	Weight/unit [kg]
000, 00, 0, 1, 2, 3	Compact	OFAE504	1SCA022007R6880	1	0.16
000, 00, 0, 1, 2, 3	690 V	OFAE505	2CMA125276R1000	1	0.80

Electronic fuse monitor

Suitable for 1- and 3-phase circuits.

Rated voltage [Vac]	Type	Order number	Units/type [pcs]	Weight/unit [kg]
100...260	OFM260	1SCA022459R8560	1	0.14
380...690	OFM690	1SCA022459R8480	1	0.14
120...260	OFS260	1SCA022716R0180	1	0.14
380...690	OFS690	1SCA022715R9920	1	0.14

Crimp terminals for connecting fuse monitor to the switch fuse type OS_

Suitable for switch fuse	Flat terminal size [mm]	Type	Order number	Units/type [pcs]	Weight/unit [kg]
OS-switch fuse	2.8 - 0.8	OFMZX2	1SCA022475R9910	6	0.01

Technical data¹⁾

Power circuit

Connection wire no:s 1, 3, 5	Double insulated 0.75 mm ² Cu, length 60 cm
Connection wire no:s 2, 4, 6	0.75 mm ² Cu, length 60 cm
Rated voltage OF_ 260	100/120 Vac ... 260 Vac
Rated voltage OF_ 690	380 Vac ... 690 Vac
Voltage tolerance	-10% ... +10%
Power consumption	< 3 VA
Rated frequency	50 / 60 Hz
Measuring impedance	> 1000 Ω/V
Impulse test voltage (1.2 / 50 μs)	9.8 kV
Phase to phase / Supply to load	

Output terminals (Auxiliary contacts)

Terminals	OFM 13-14 (NO), 21-22 (NC)
Wire section:	OFS 11-14 (NO), 21-22 (NC)
Flexible Cu	≤ 1,5 mm ²
Rigid Cu	≤ 2,5 mm ²
Rated current I _e	4A / 250Vac / AC1 3A / 250Vac / AC15 2A / 24Vdc / DC13
Rated voltage / max. breaking voltage	250 Vac / 440 Vac
Rated breaking capacity	2000 VA
Contact material	Cadmium free

Characteristics

Specified ambient air temperature range	-25...+55 °C
Transport and storage temperature range	-40...+70 °C
Operating time	< 2 sec
Overvoltage category / Pollution severity	III / 3 IEC 60947-1
Dielectric test voltage:	
Power circuit/output terminals	5 kVrms / 1min 50Hz

EMC (OFM):

Emission	
Conducted emission	EN 55022 (1994) Class B
Radiated emission	EN 55022 (1994) Class B
Harmonic currents emissions	EN 61000-3-2 (1995) Class A
Immunity	

Electrostatic discharge (ESD)	EN 61000-4-2 (1995) Criteria B (Contact/Air)	Level 2/3
RF Radiated field	EN 61000-4-3 (1996) Criteria A	Level 3
Electrical fast transient (EFT)	EN 61000-4-4 (1995) Criteria B	Level 3
RF Electromagnetic conducted	EN 61000-4-6 (1996) Criteria A	Level 3
RF Electromagnetic field (GSM)	ENV 50204 (1995) Criteria A	

Magnetic field immunity

Continuous	EN 61000-4-8 (1993)	Level 5
Pulse 1.2 / 50 μs	EN 61000-4-9 (1993)	Level 5

Housing Self-extinguish thermoplast with V-0 behavior in accordance with UL 94

Degree of protection: IP 20

Weight 140 g

¹⁾ The connection diagram on page 39



HRC fuse links gG

Time-current characteristics

Time-current characteristics, 500 V, gG- fuse links OFAF_H_, sizes 000...4/4a

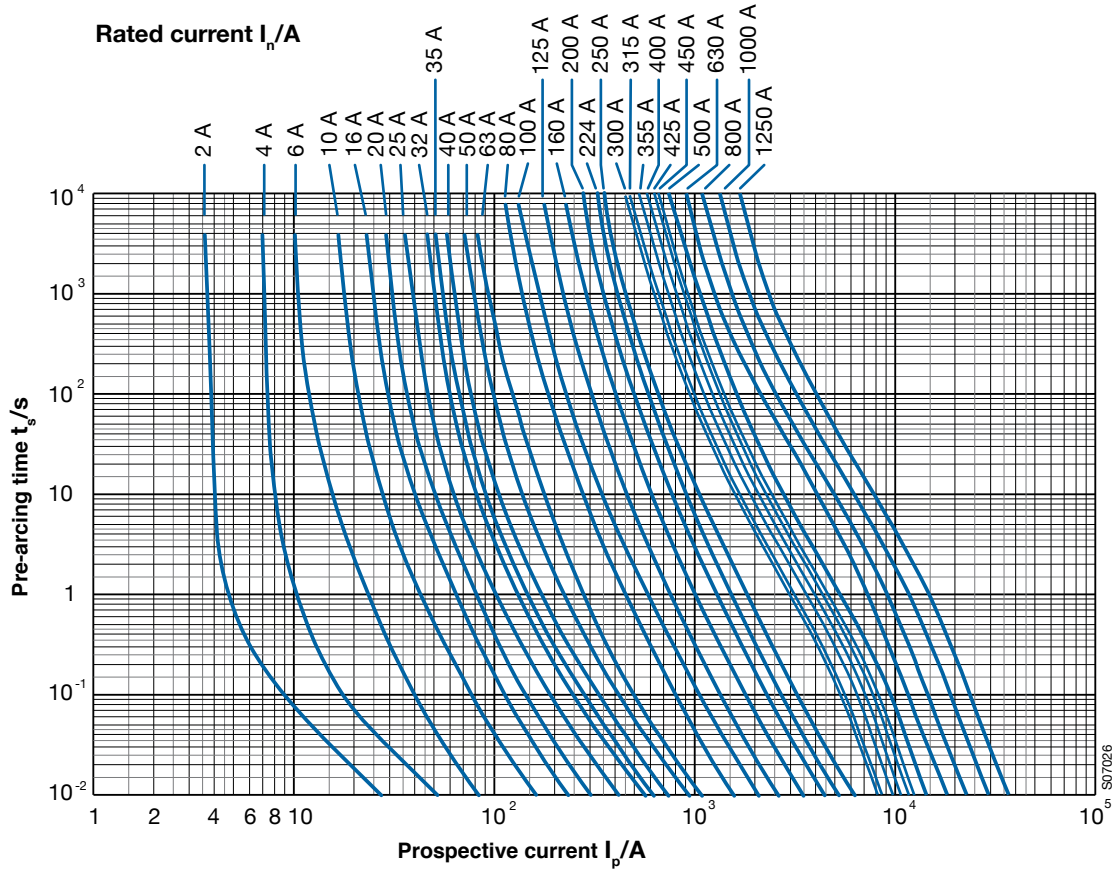



HRC fuse links gG

Time-current characteristics

Time-current characteristics, 690 V, gG- fuse links OFAA_GG_, sizes 000...5

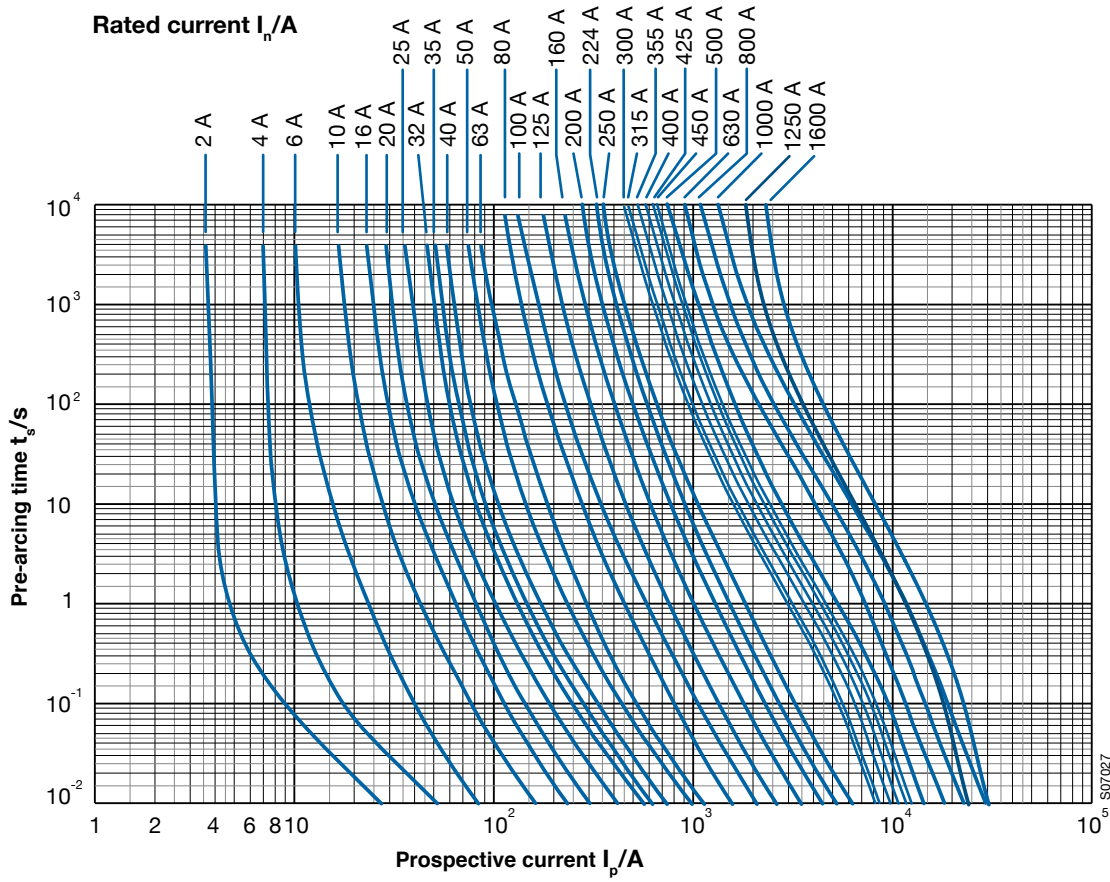



HRC fuse links gG

Time-current characteristics

Time-current characteristics, 690 V, gG- fuse links OFAA_H_ and OFAA_H_-H20, sizes 00...3

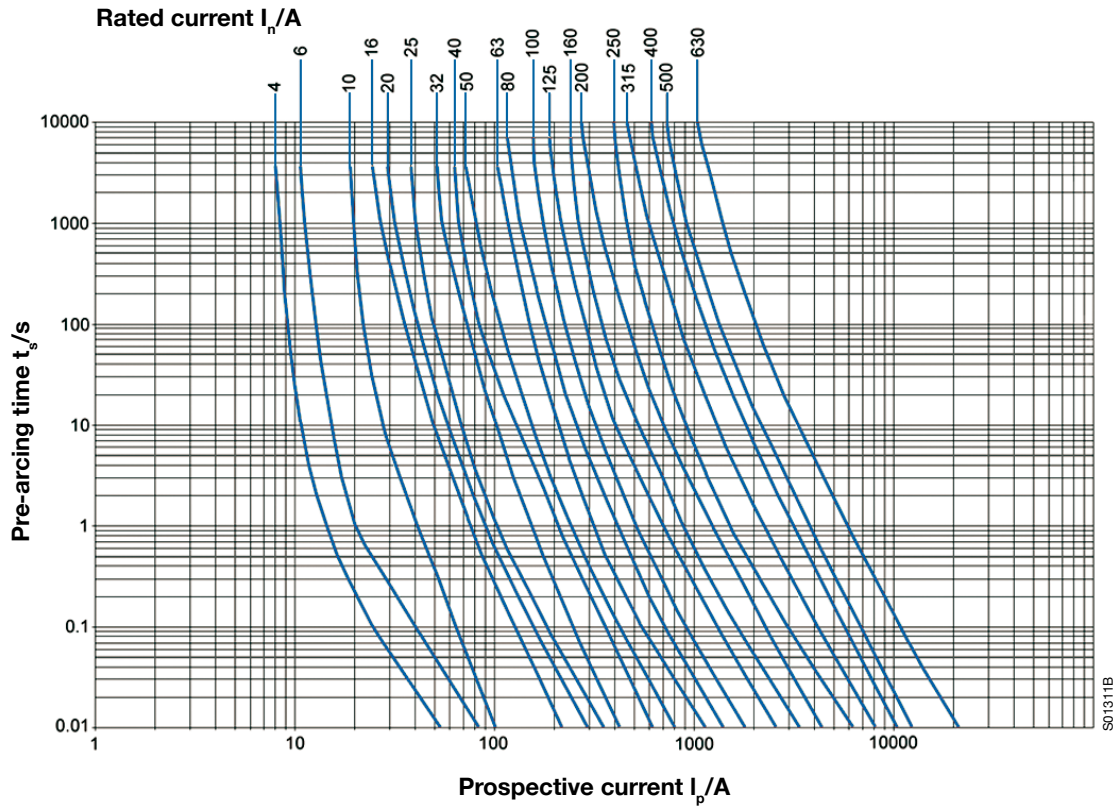



HRC fuse links aM

Time-current characteristics

Time-current characteristics, 500 V, aM- fuse links OFAF_AM_, sizes 000...3

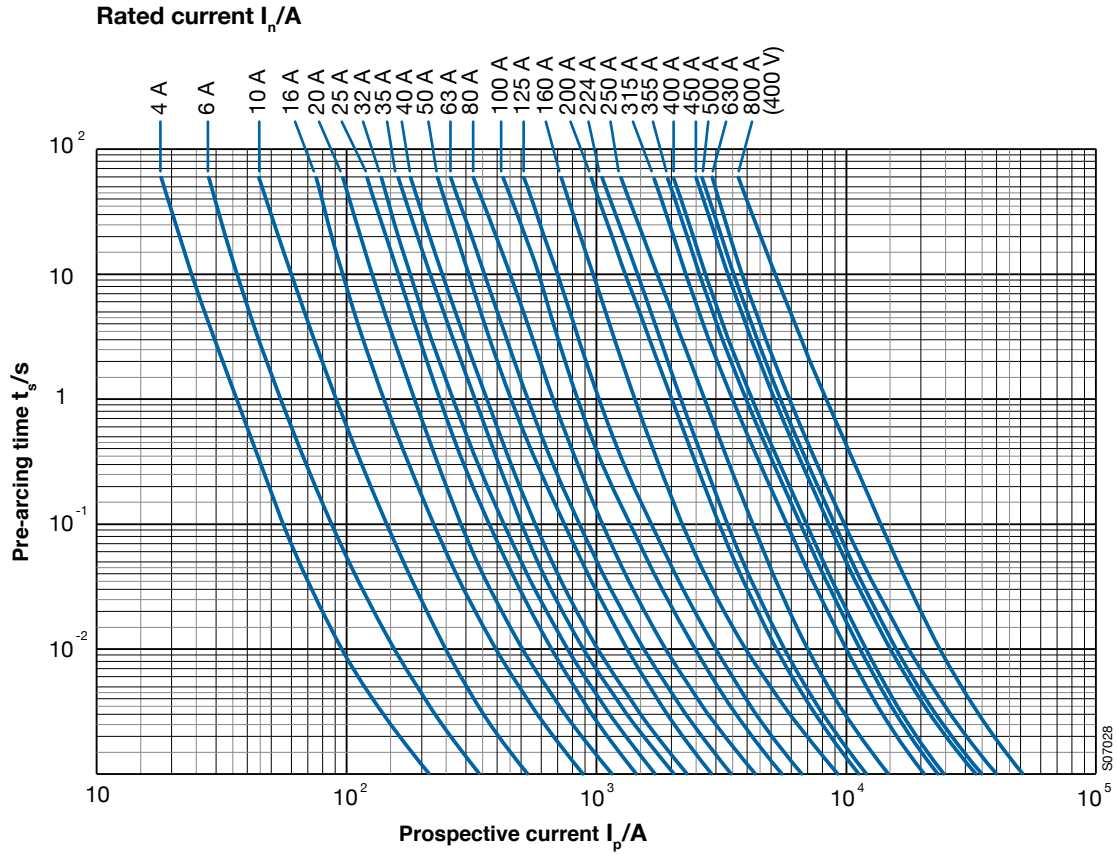



HRC fuse links aM

Time-current characteristics

Time-current characteristics, 690 V, aM-fuse links OFAM_ AM- and OFAM_AM_-H20, sizes 00...3

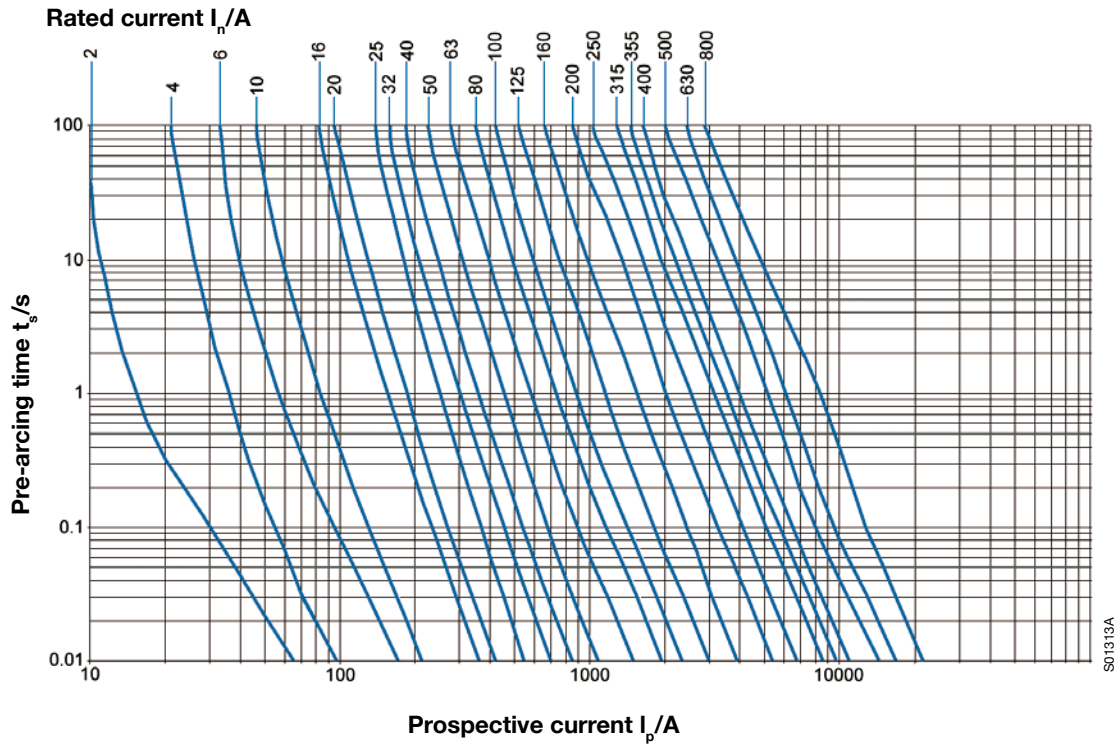

S01313A



HRC fuse links aM

Time-current characteristics

Time-current characteristics, 690 V, aM- fuse links OFAA_AM_, sizes 000...3

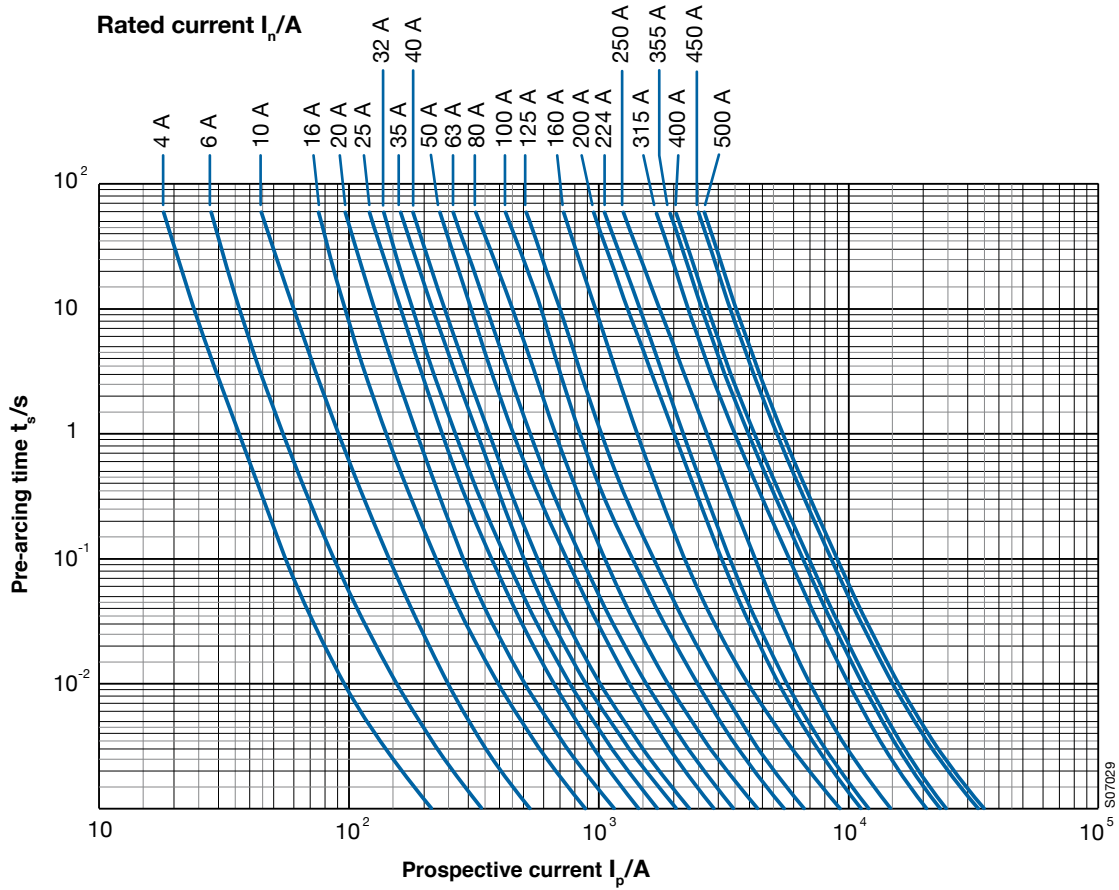



HRC fuse links gG Cut-off current characteristics

Current limitation, 500 V, gG- fuse links OFAF_H_, sizes 000...4/4a

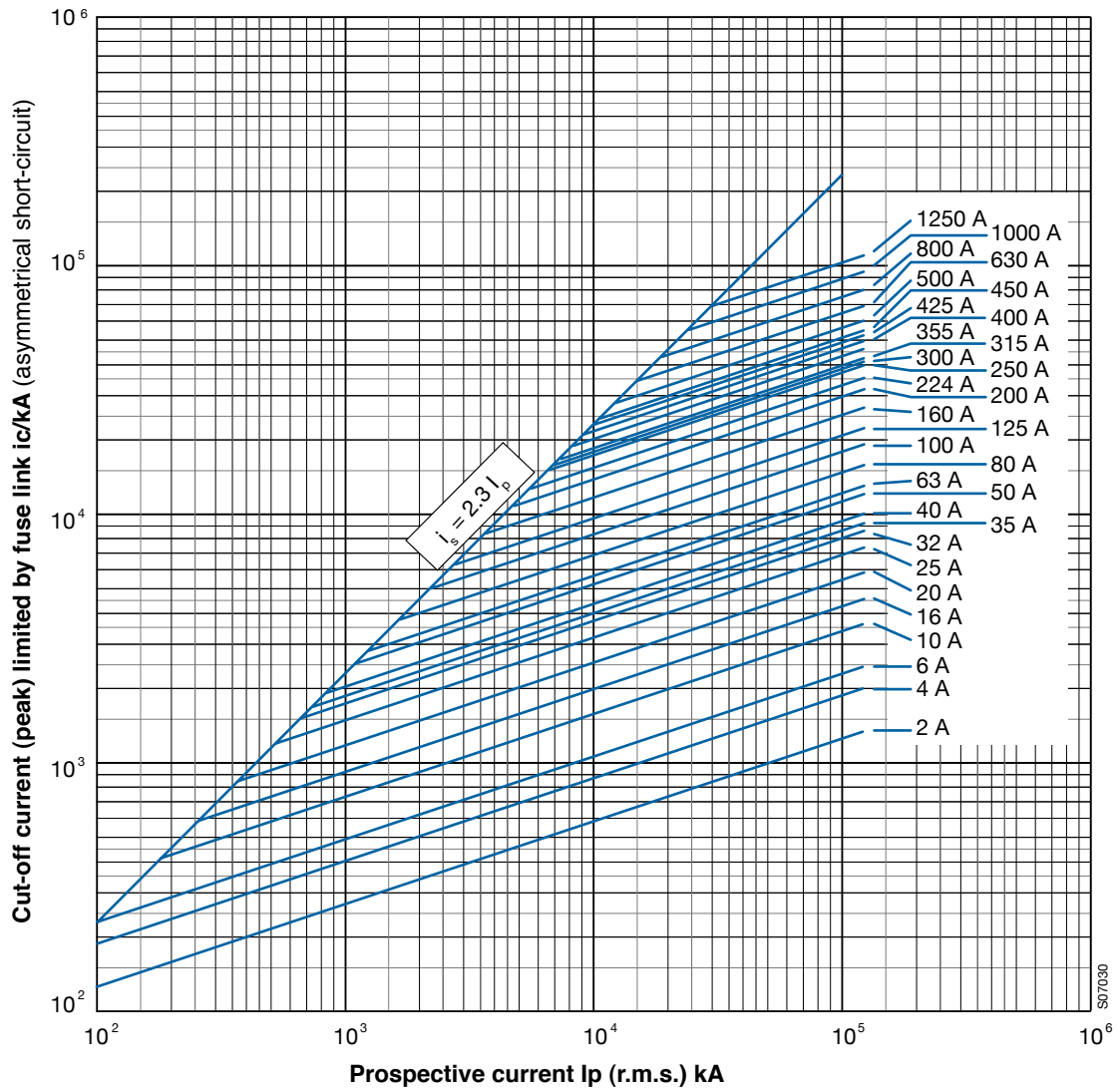



HRC fuse links gG Cut-off current characteristics

Current limitation, 690 V, gG- fuse links OFAA_GG_, sizes 000...4/4a

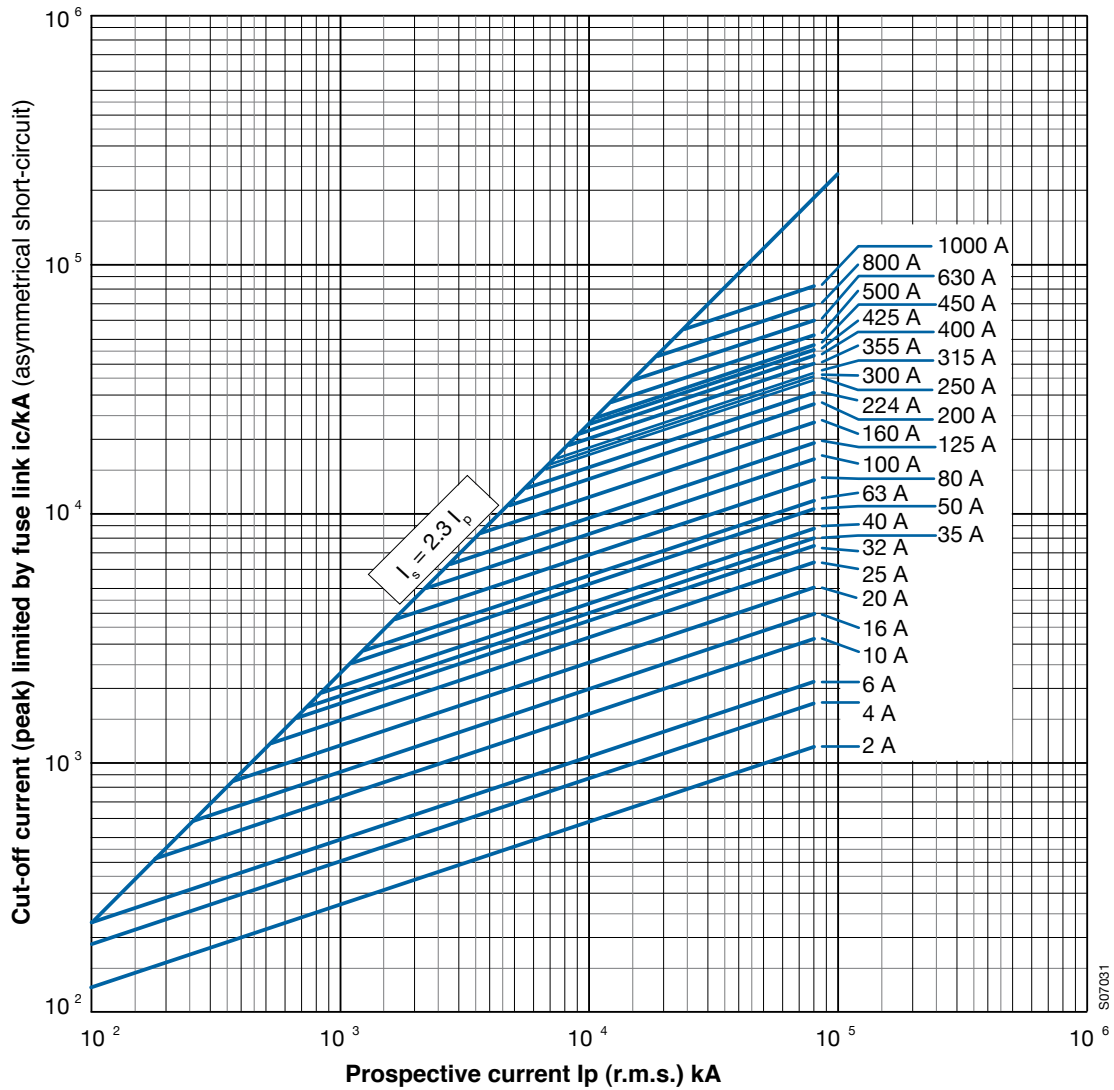



HRC fuse links gG Cut-off current characteristics

Current limitation, 690 V, gG- fuse links OFAA_GG_, size 5

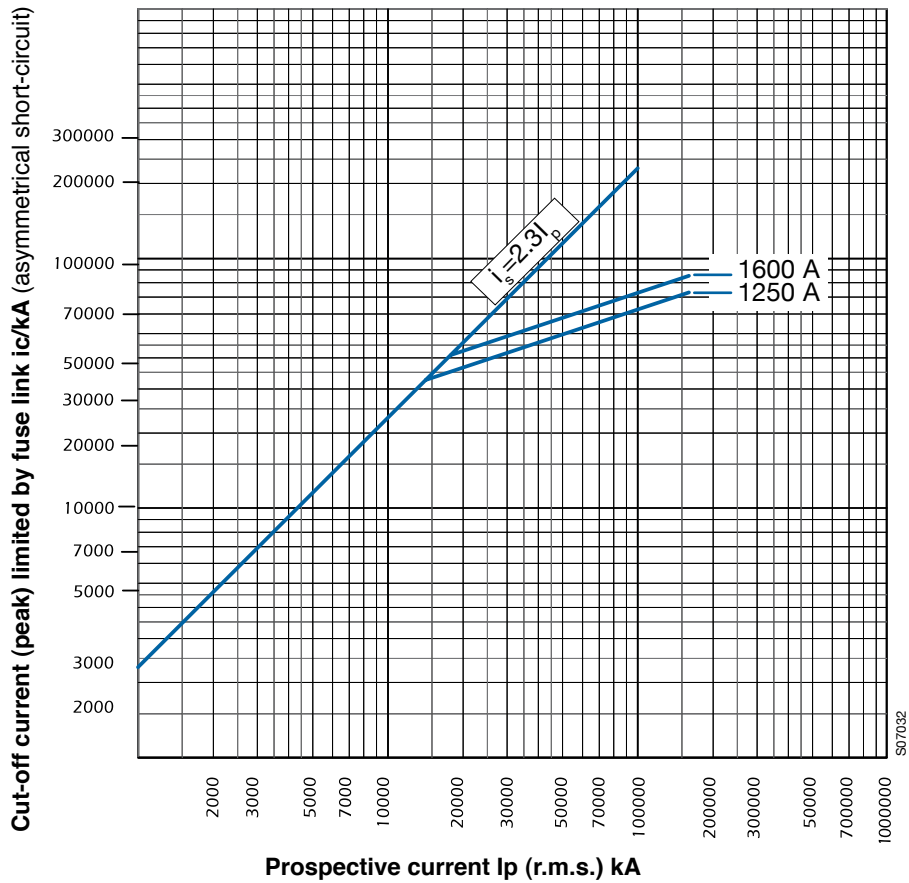



HRC fuse links gG

Cut-off current characteristics

Current limitation, 690 V, gG- fuse links OFAA_H_ and OFAA_H_-H20, sizes 00...3

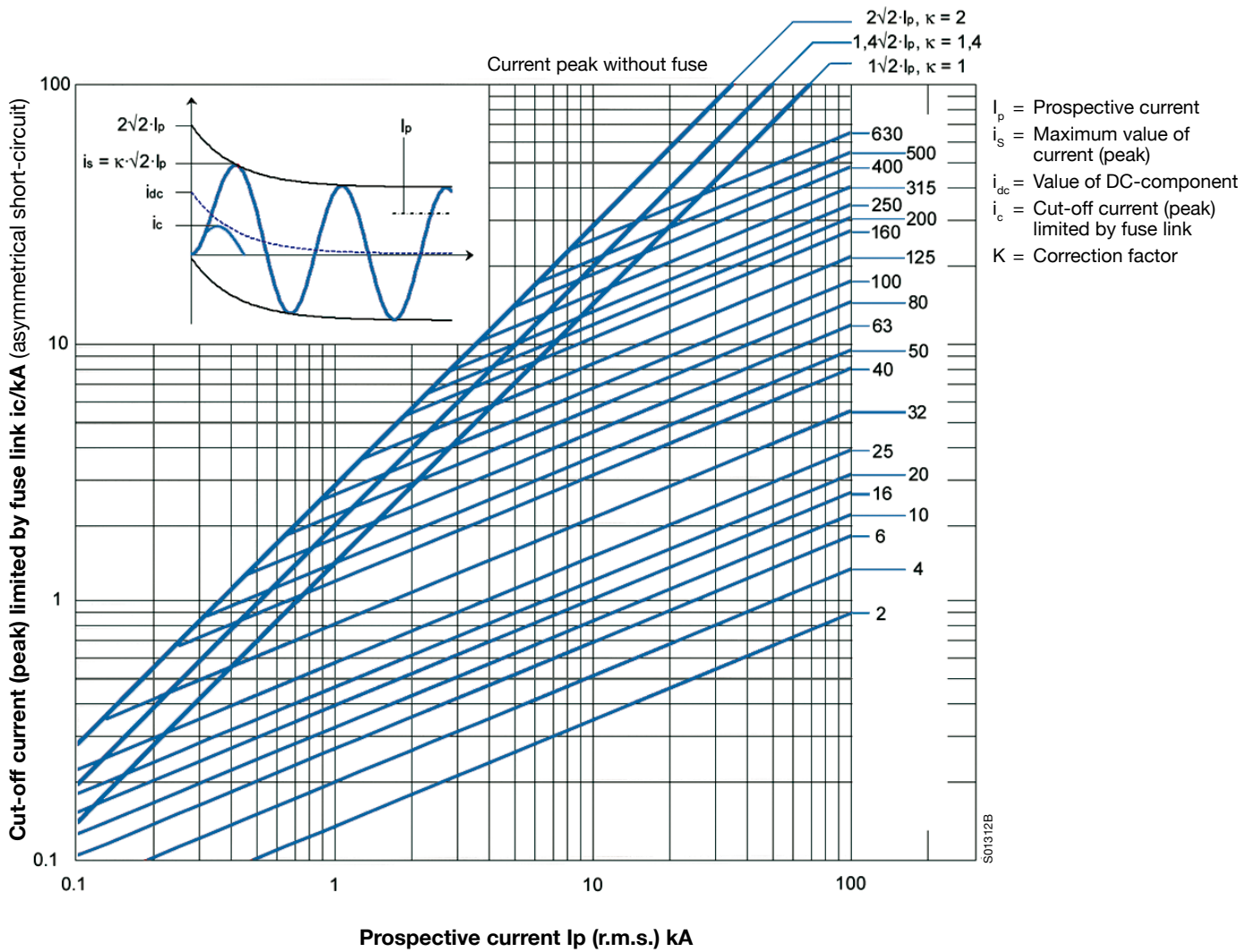



HRC fuse links aM

Cut-off current characteristics

Current limitation, 500 V, aM- fuse links OFAF_AM_, sizes 000...3

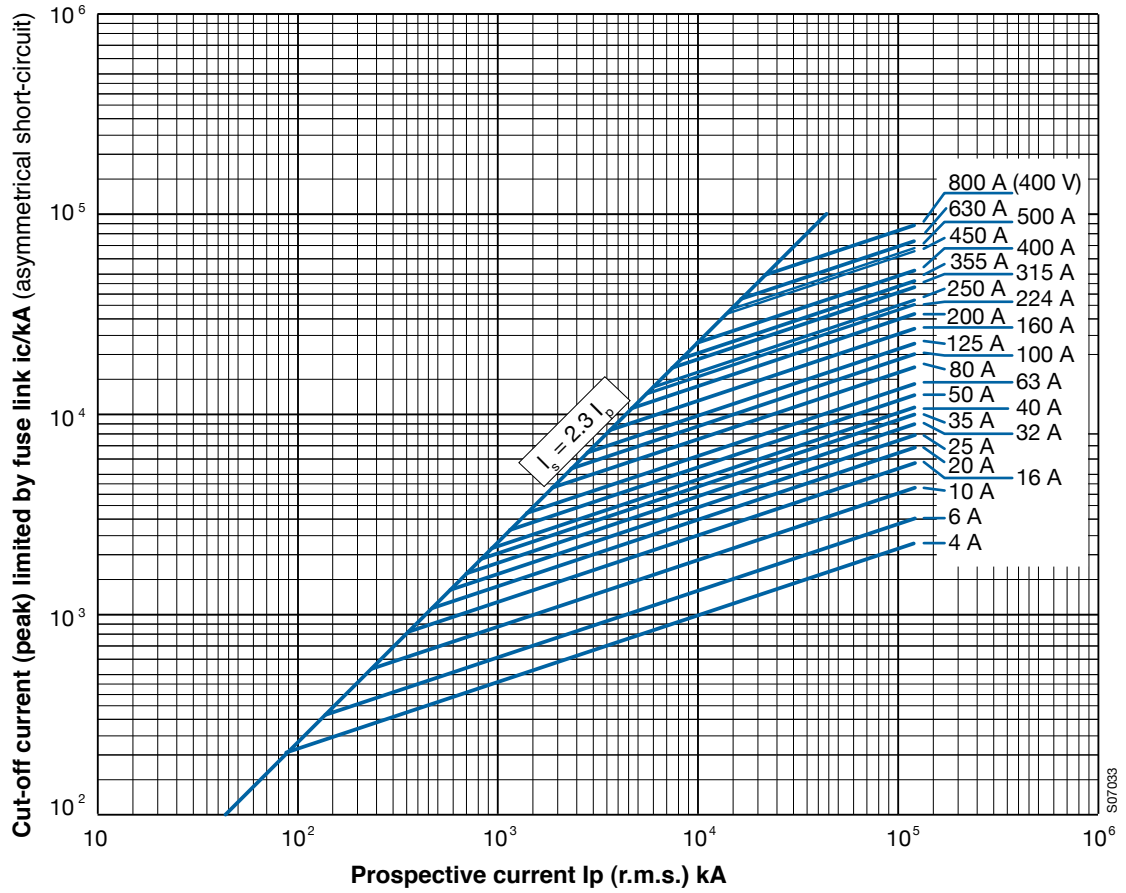



HRC fuse links aM

Cut-off current characteristics

Current limitation, 690 V, aM-fuse links OFAM_AM_ and OFAM_AM_-H20, sizes 00...3

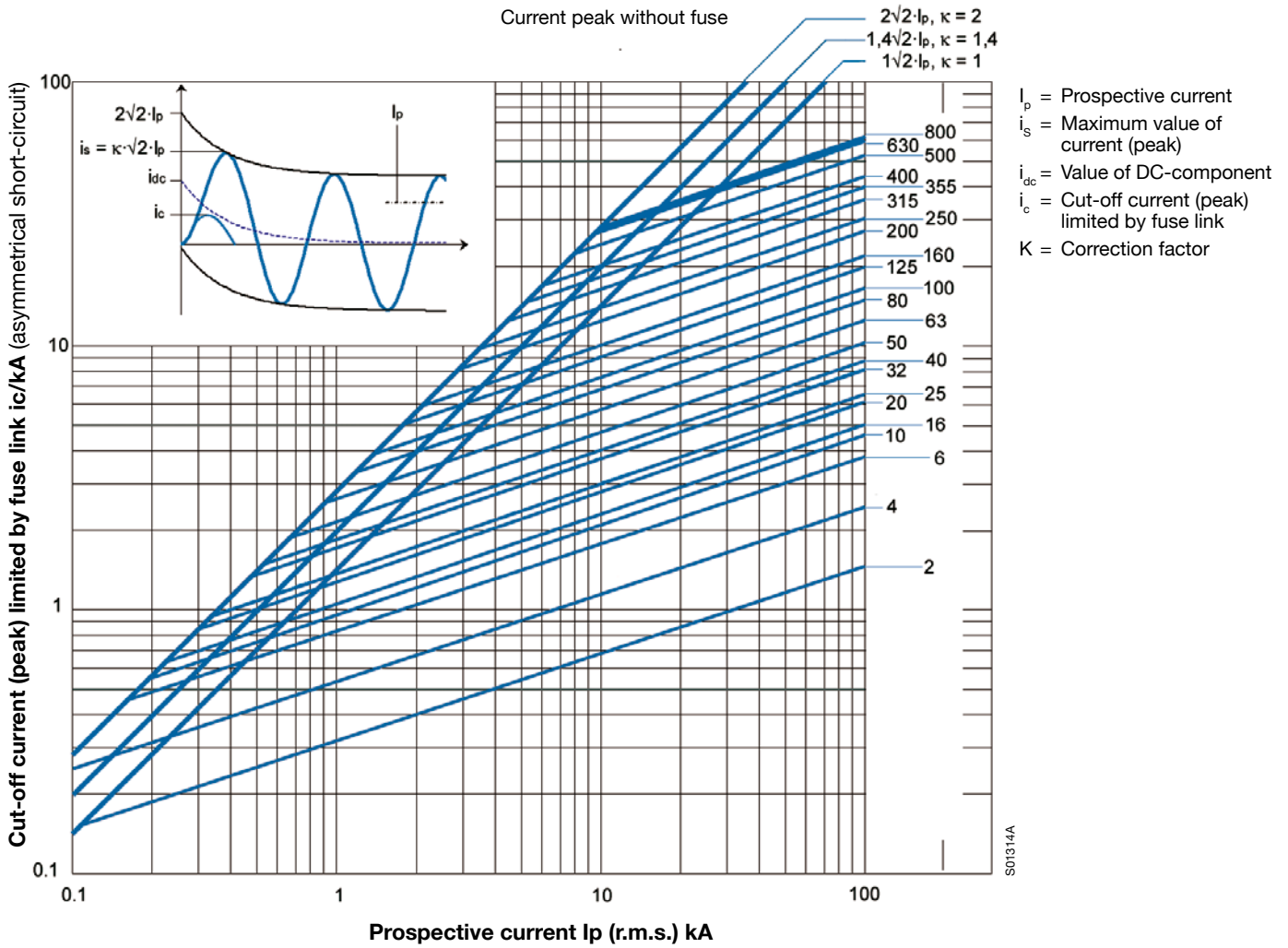



HRC fuse links aM

Cut-off current characteristics

Current limitation, 690 V, aM- fuse links OFAA_AM_, sizes 000...3

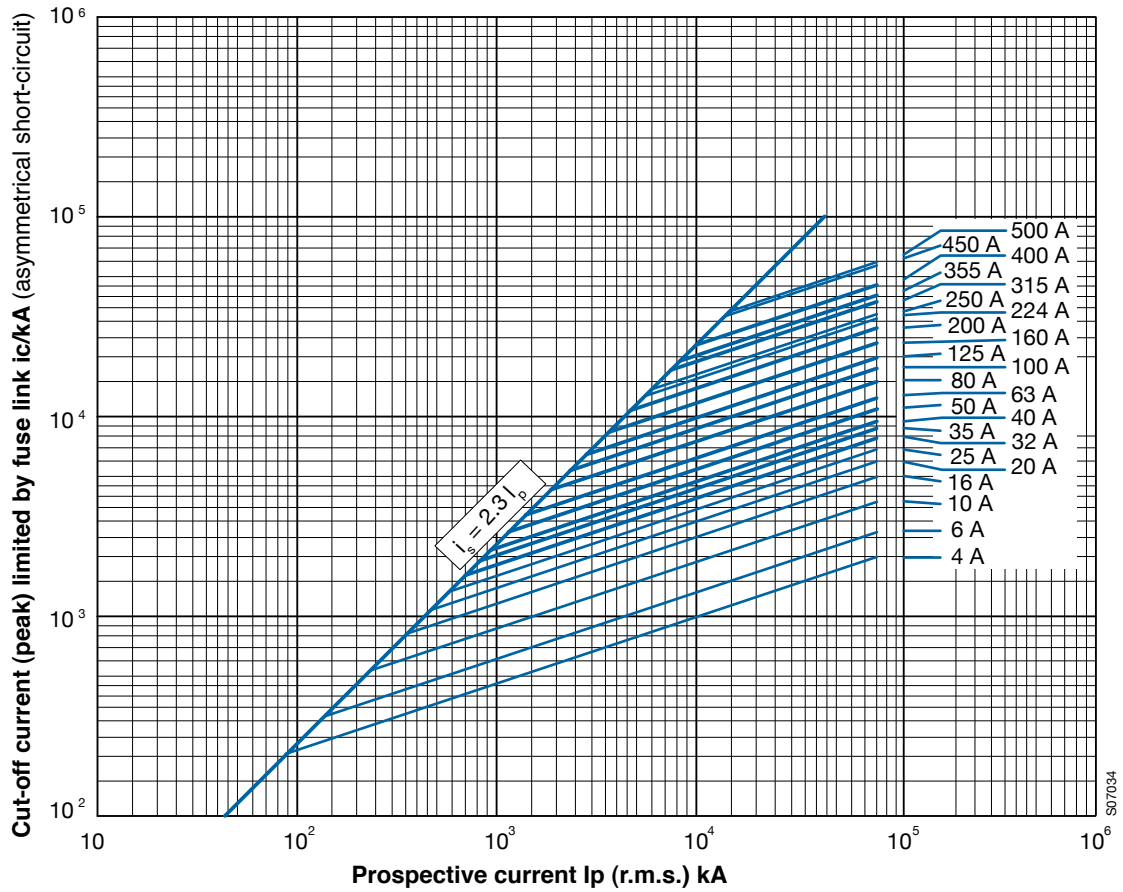



HRC Fuse links, gG I²t characteristics

I²t characteristics, 500 V, gG- fuse links OFAF_H_, sizes 000...4/4a

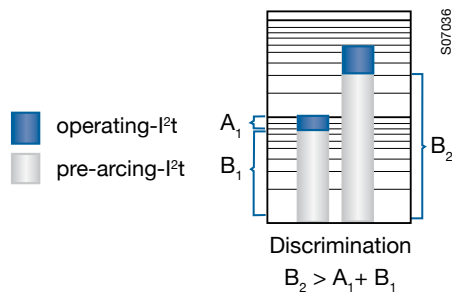
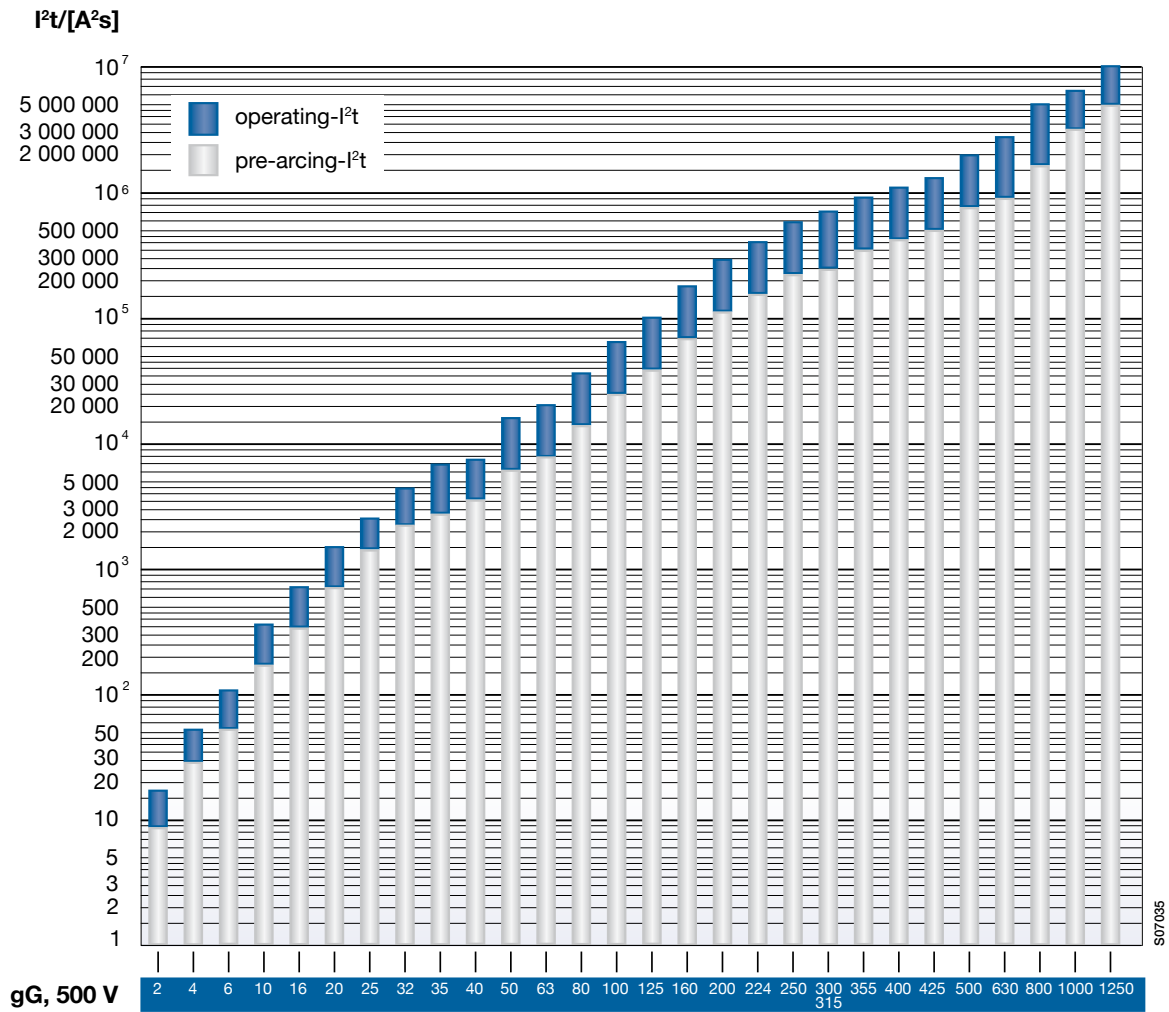



HRC Fuse links, gG I²t characteristics

I²t characteristics, 690 V, gG- fuse links OFAA_GG_, sizes 000...5

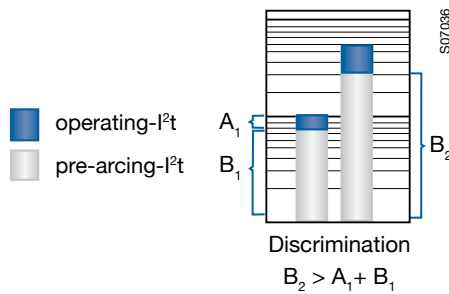
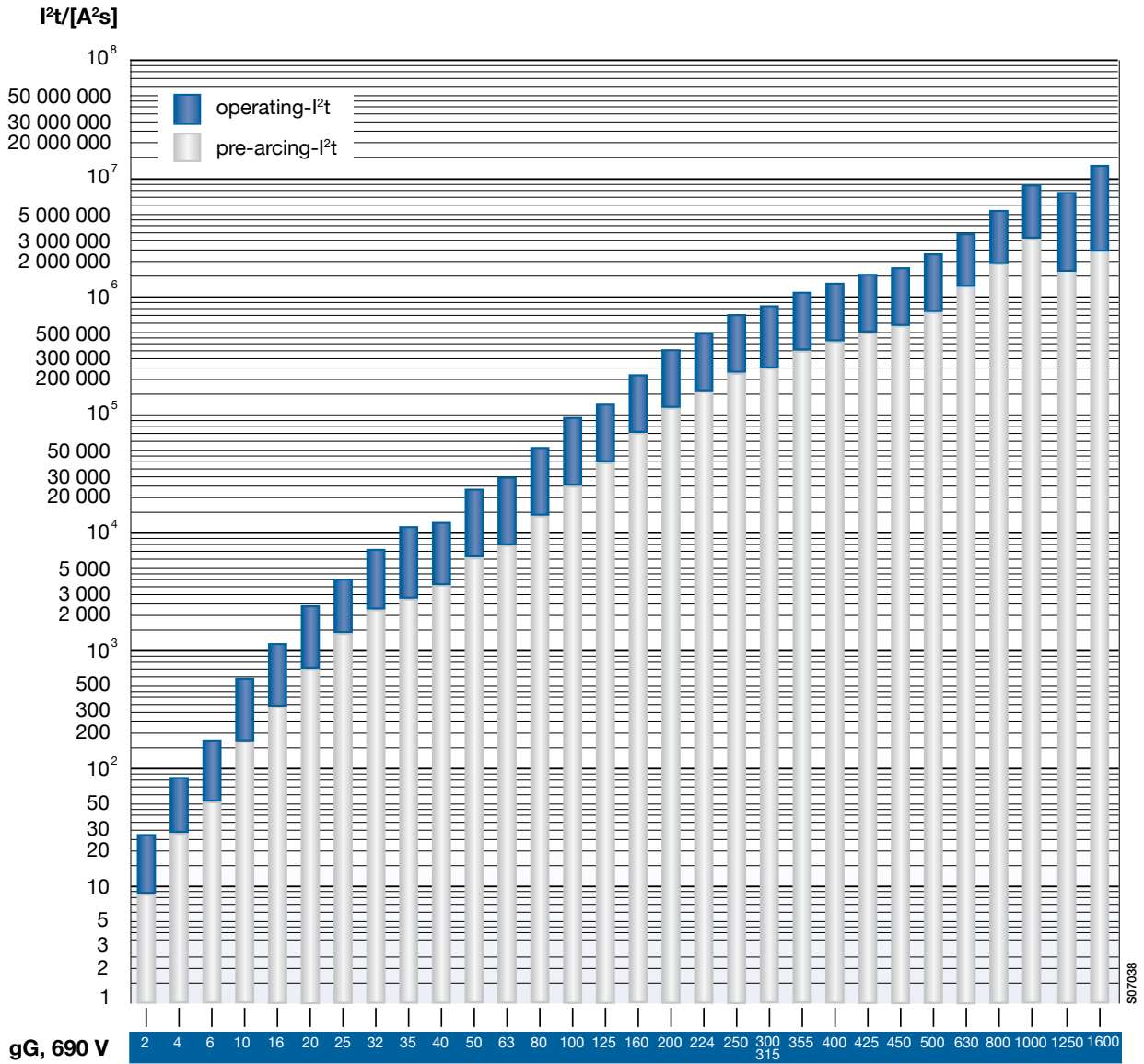



HRC Fuse links, gG I²t characteristics

I²t characteristics, 690 V, gG- fuse links OFAA_H_ and OFAA_H_-H20, sizes 00...3

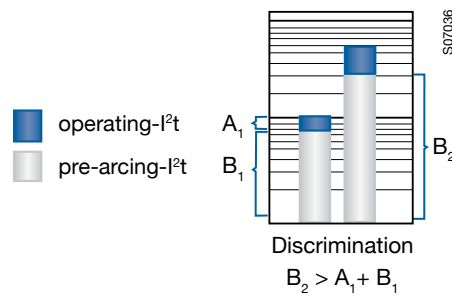
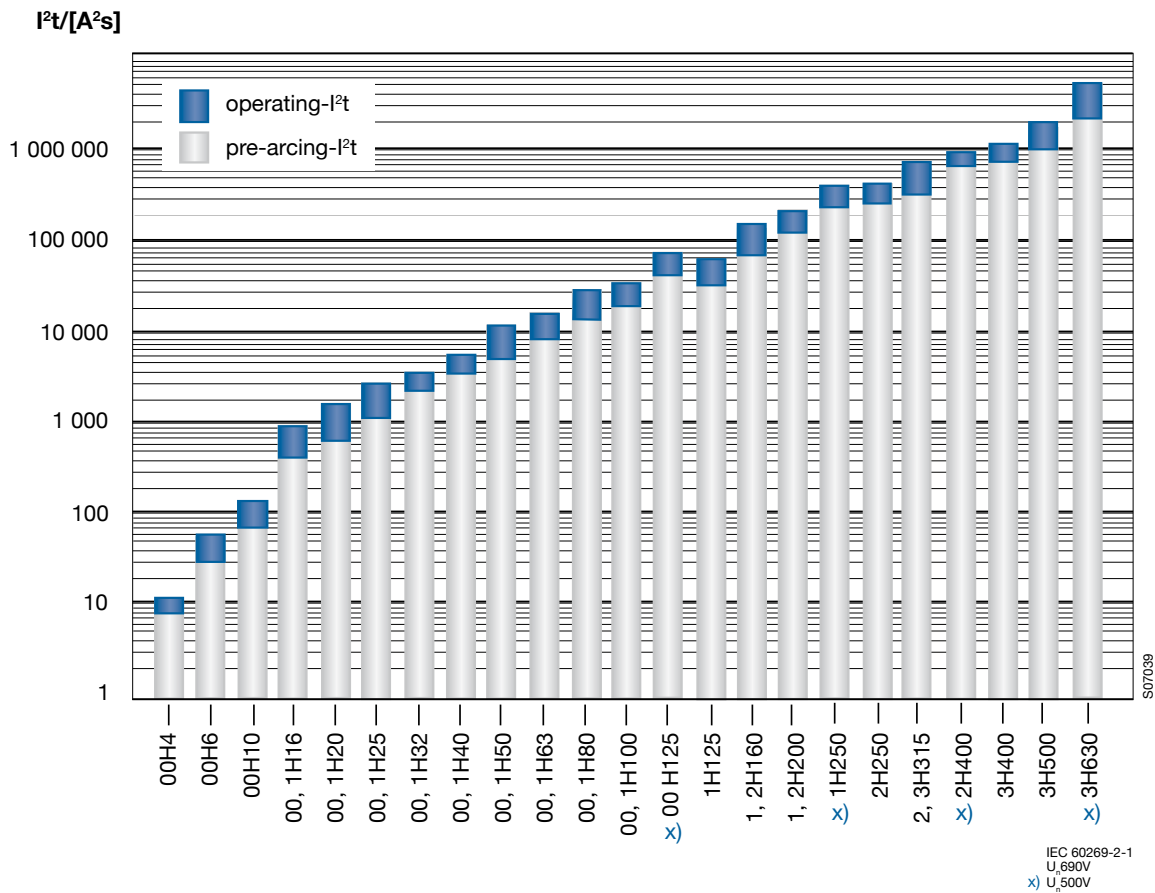



HRC Fuse links, aM I²t characteristics

I²t characteristics, 500 V, aM- fuse links OFAF_AM_, sizes 000...3

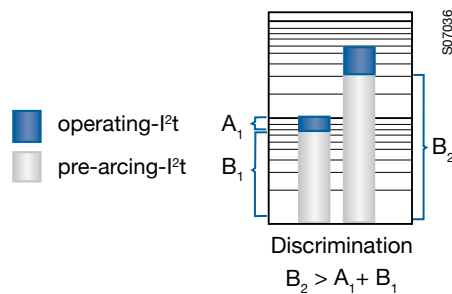
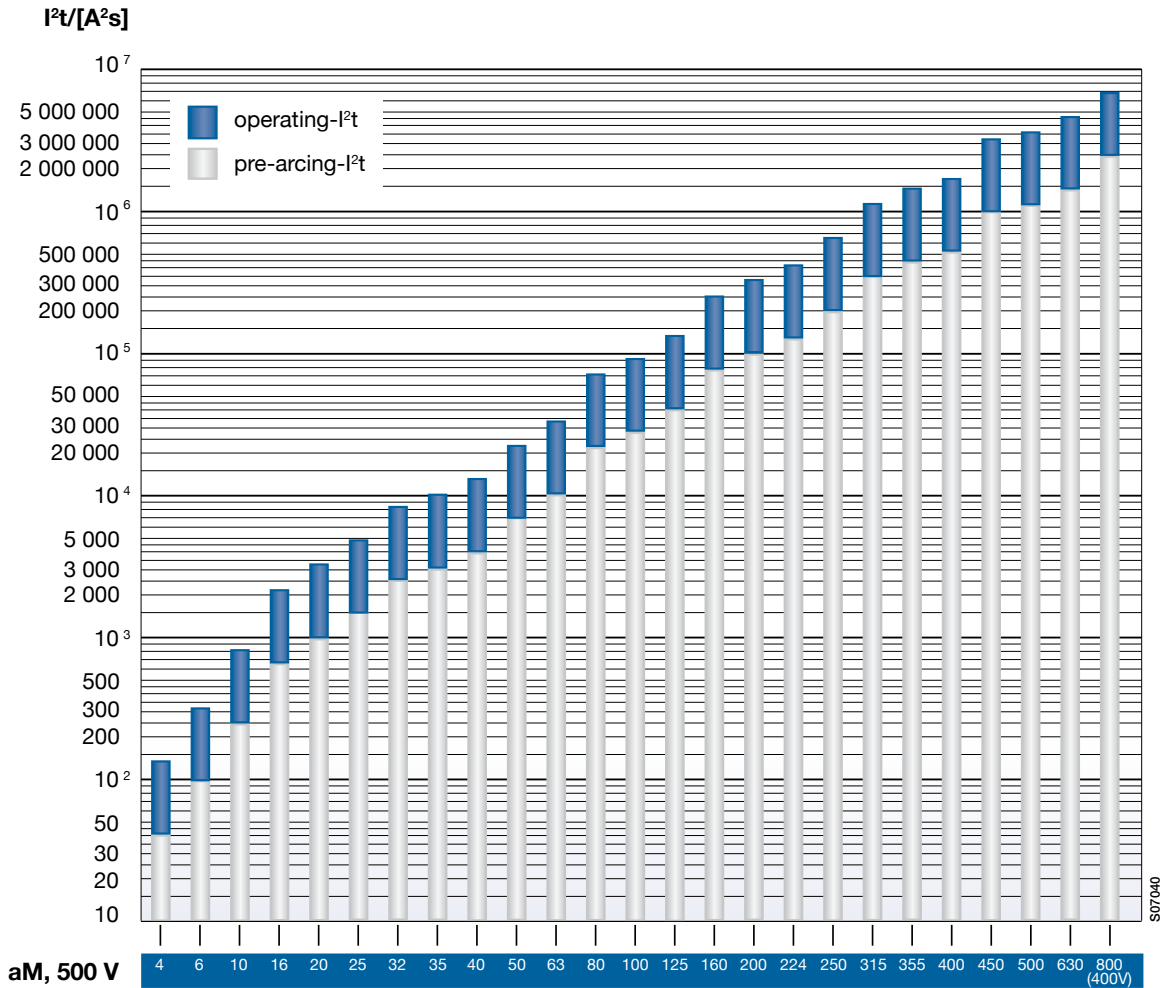



HRC Fuse links, aM I²t characteristics

I²t characteristics, 690 V, aM-fuse links OFAM_AM_ and OFAM_AM_-H20, sizes 00...3

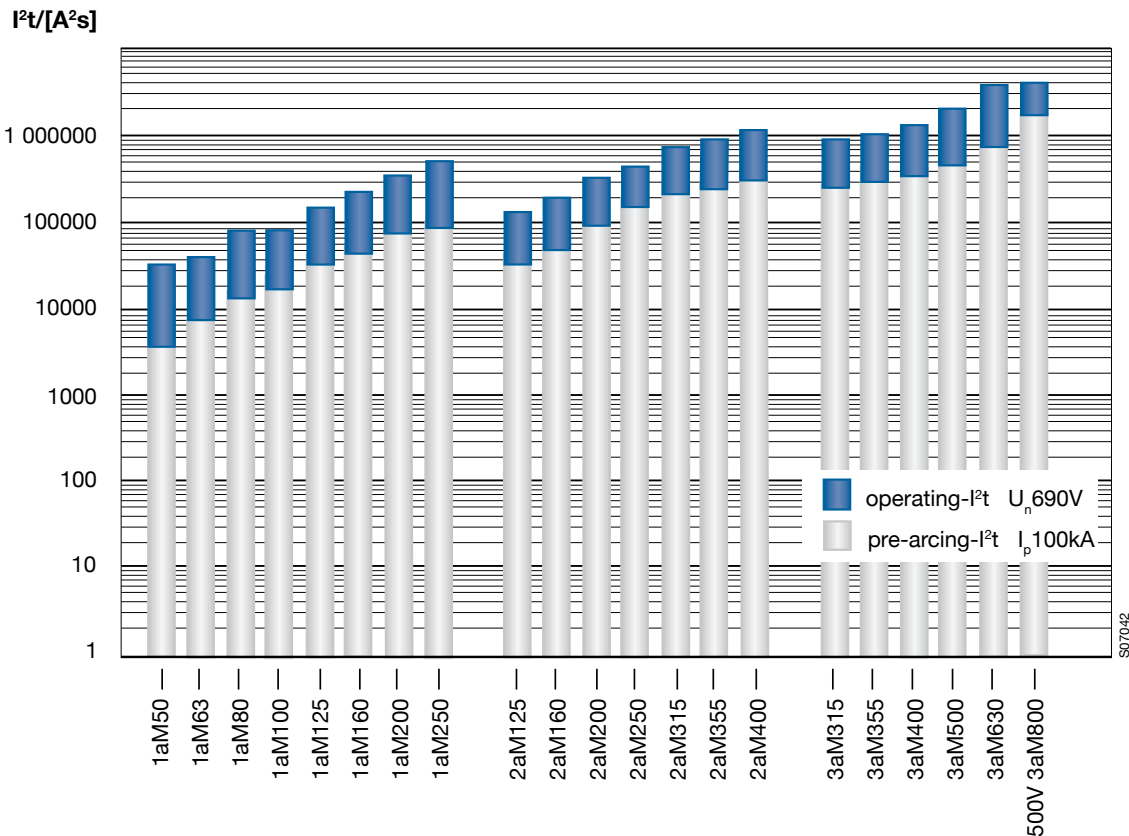
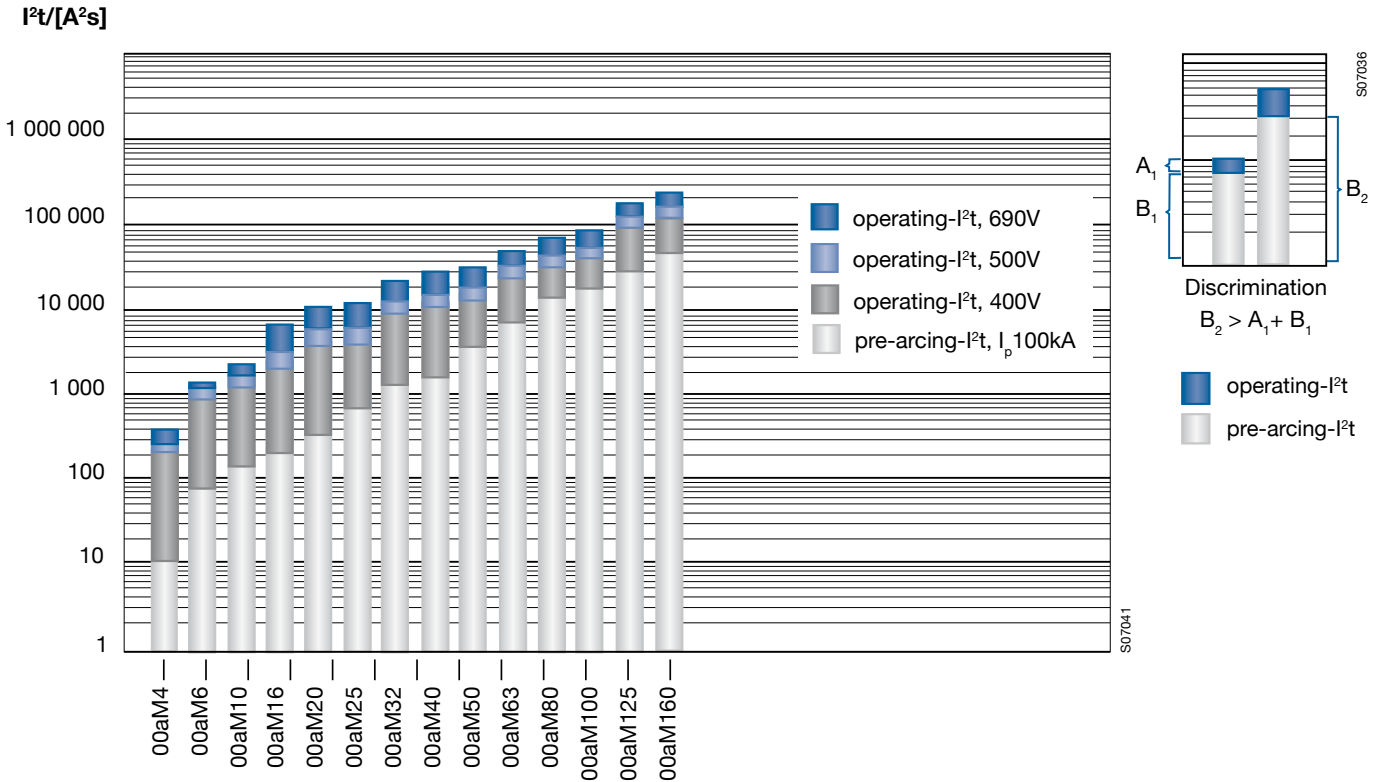

I²t characteristics, 690 V, aM- fuse links OFAA_AM_, sizes 000...3

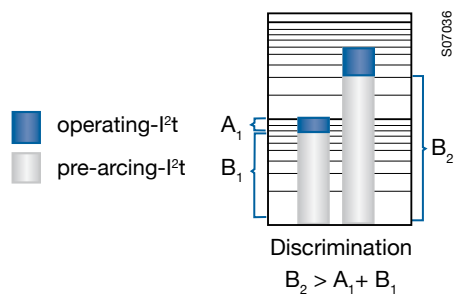
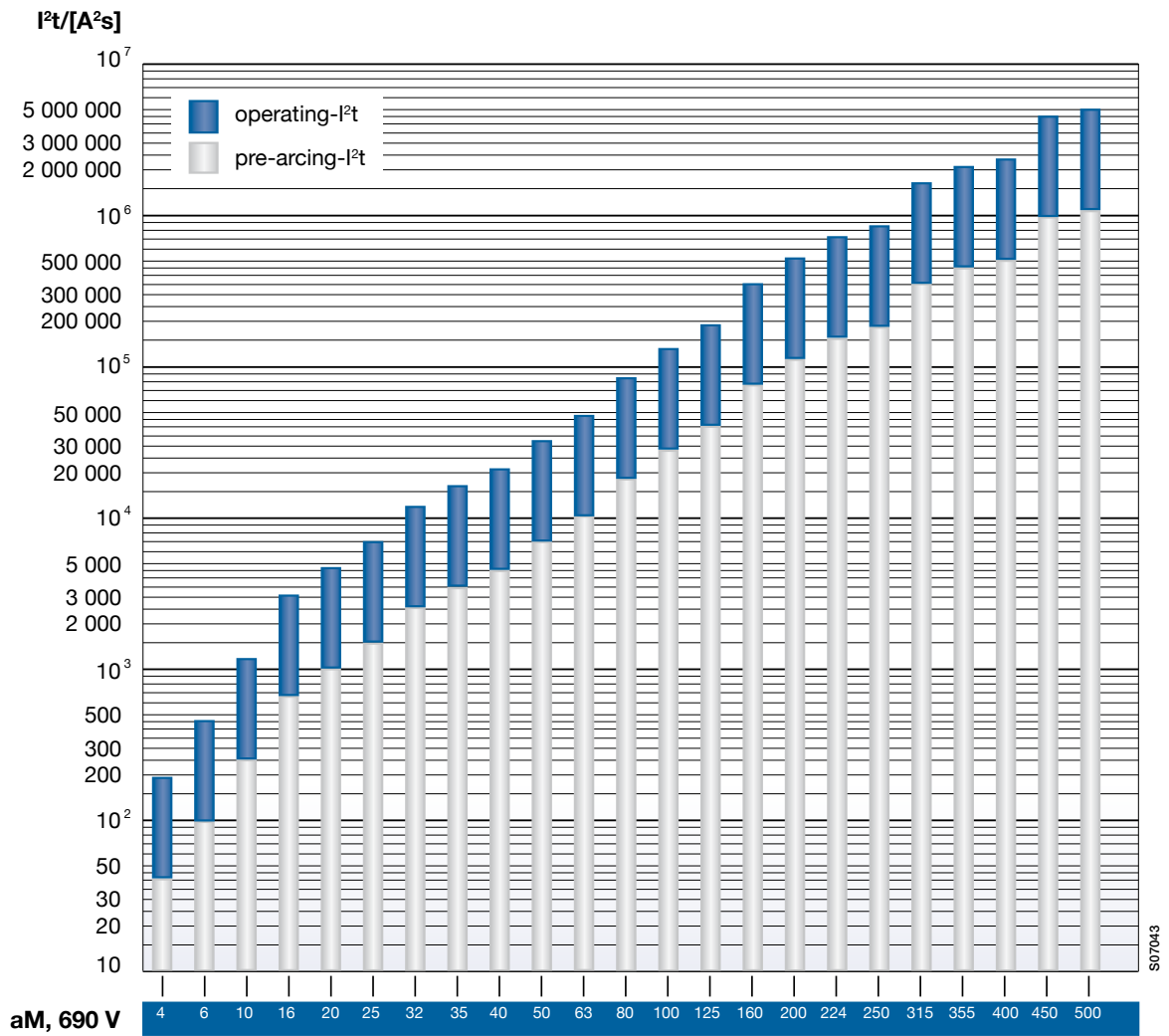



HRC Fuse links gG, aM Dimension drawings

gG- and aM- fuse links

OFAF_H_
OFAA_GG_
OFAF_AM_
OFAA_AM_

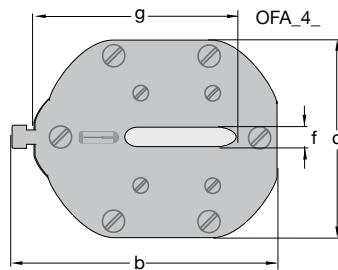
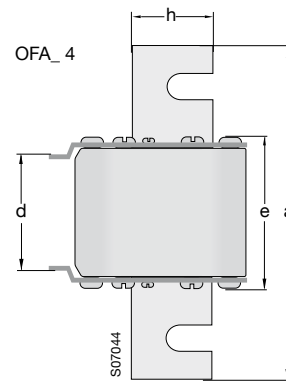
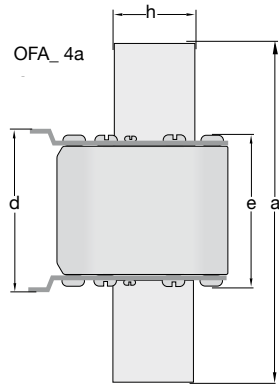
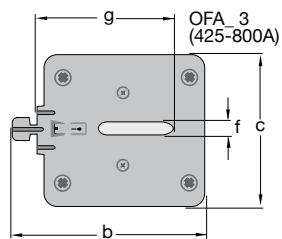
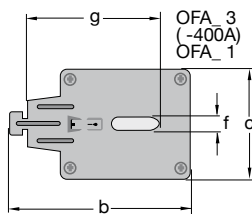
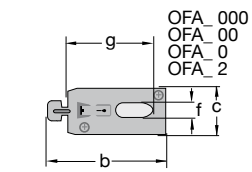
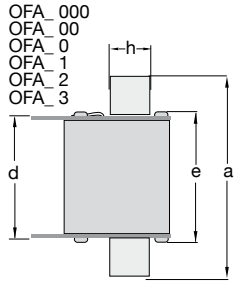

Fuse link	IEC-size	a	b	c	d	e	f	g	h
OFA_000_	000	79	52,5	20,8	49,5	52	6	35	15
OFA_00_	00	79	59,5	29,5	50	52,8	6	35	15
OFA_0_6-160	0	125	59,5	29,5	66	66,8	6	35	15
OFA_0_200-250	0	125	59,5	39,5	66	66,8	6	35	20
OFA_1_16-100	1	135	64,5	29,5	68	70,8	6	40	15
OFA_1_125-315	1	135	66	39,5	68	70,8	6	40	20
OFA_2_35-250	2	150	72	39,5	68	72,3	6	48	20
OFA_2_300-500	2	150	72	51	68	72,3	6	48	26
OFA_3_250-400	3	150	83,5	51	68	72,3	6	60	26
OFA_3_425-800	3	150	86	70	68	72,3	6	60	33
OFA_4_	4	200	119	89	68	85	8	85	49
OFA_4A_	4a	200	119	89	88	85	8	85	49

gG- and aM- fuse links

OFAA_H_
OFAA_H_-H20
OFAM_AM_
OFAM_AM_-H20

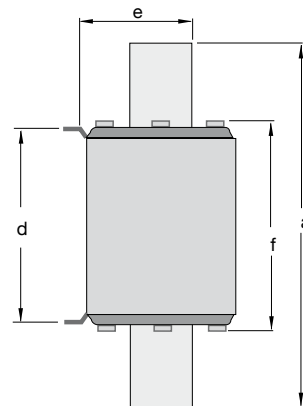
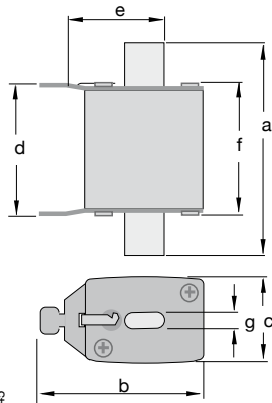

Fuse link	IEC-size	a	b	c	d	e	f	g
OFA_00_	00	79	59	30	48	35	52	6
OFA_1_	1	135	62	49	65,5	40	74	6
OFA_2_	2	150	70	57	65,5	48	74	6
OFA_3_	3	150	84,5	72	65,5	60	74	6

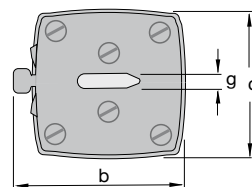



HRC Fuse links, fuse monitor

Dimension drawings, connecting diagram

gG- fuse links, OFAA5GG1600

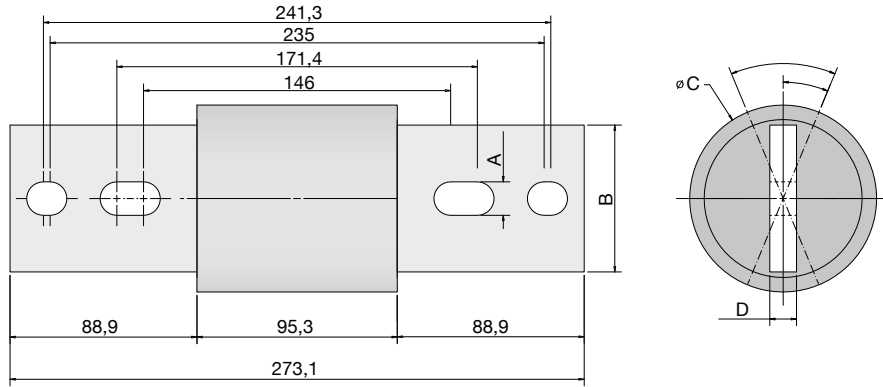

	A	B	C	D
OFAA5GG1200	15,9	60,3	76,2	11,1
OFAA5GG1600	15,9	69,8	88,9	12,7

S04116

Fuse monitor

OFM

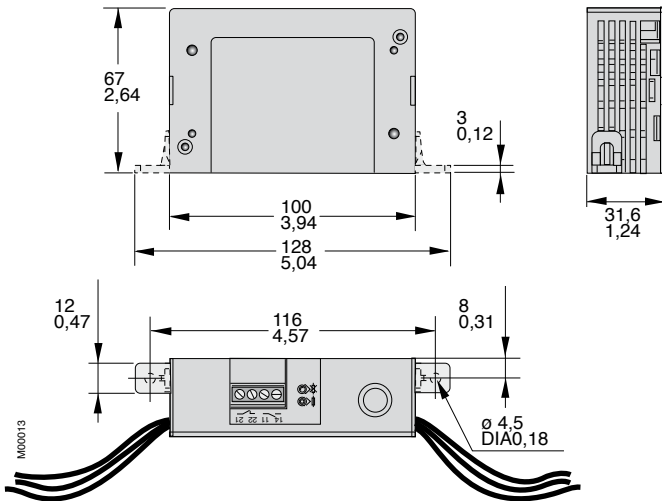

OFS

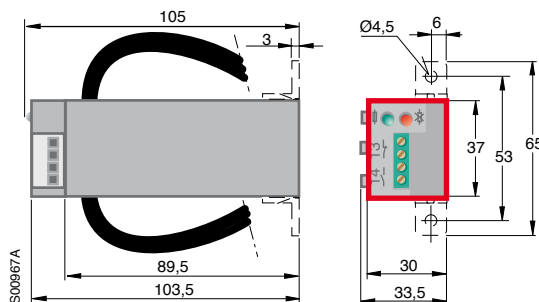

Fuse monitor, connecting diagram

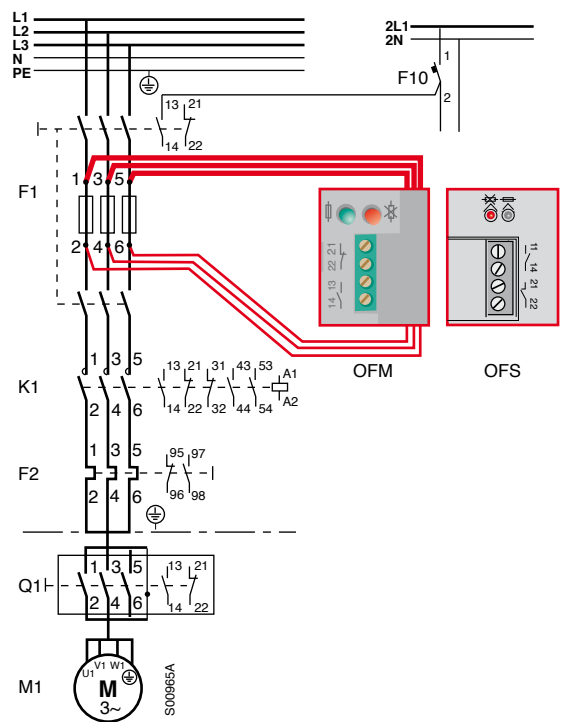



Index

Type	Order number	Page	Description
OFAA000AM10	1SCA022660R8290	16	HRC fuse link, aM
OFAA000AM16	1SCA022660R8370	16	HRC fuse link, aM
OFAA000AM2	1SCA022660R7640	16	HRC fuse link, aM
OFAA000AM20	1SCA022660R8450	16	HRC fuse link, aM
OFAA000AM25	1SCA022660R8530	16	HRC fuse link, aM
OFAA000AM32	1SCA022660R8610	16	HRC fuse link, aM
OFAA000AM35	1SCA022660R8700	16	HRC fuse link, aM
OFAA000AM4	1SCA022660R8020	16	HRC fuse link, aM
OFAA000AM40	1SCA022660R8880	16	HRC fuse link, aM
OFAA000AM50	1SCA022660R8960	16	HRC fuse link, aM
OFAA000AM6	1SCA022660R8110	16	HRC fuse link, aM
OFAA000AM63	1SCA022660R9000	16	HRC fuse link, aM
OFAA000GG10	1SCA022661R8500	9	HRC fuse link, gG
OFAA000GG16	1SCA022661R8680	9	HRC fuse link, gG
OFAA000GG2	1SCA022661R8250	9	HRC fuse link, gG
OFAA000GG20	1SCA022661R8760	9	HRC fuse link, gG
OFAA000GG25	1SCA022661R8840	9	HRC fuse link, gG
OFAA000GG32	1SCA022661R8920	9	HRC fuse link, gG
OFAA000GG35	1SCA022661R9060	9	HRC fuse link, gG
OFAA000GG4	1SCA022661R8330	9	HRC fuse link, gG
OFAA000GG40	1SCA022661R9140	9	HRC fuse link, gG
OFAA000GG50	1SCA022661R9220	9	HRC fuse link, gG
OFAA000GG6	1SCA022661R8410	9	HRC fuse link, gG
OFAA000GG63	1SCA022661R9310	9	HRC fuse link, gG
OFAA000AM100	1SCA022701R1850	16	HRC fuse link, aM
OFAA000AM125	1SCA022701R1930	16	HRC fuse link, aM
OFAA000AM80	1SCA022701R1770	16	HRC fuse link, aM
OFAA00GG100	1SCA022700R9520	9	HRC fuse link, gG
OFAA00GG125	1SCA022724R0610	9	HRC fuse link, gG
OFAA00GG80	1SCA022700R9440	9	HRC fuse link, gG
OFAA00H10	1SCA022007R4080	11	HRC fuse link, gG
OFAA00H100	1SCA022007R4830	11	HRC fuse link, gG
OFAA00H100-H20	1SCA022296R9570	12	HRC fuse link, gG
OFAA00H10-H20	1SCA022296R9310	12	HRC fuse link, gG
OFAA00H125	1SCA022078R4290	11	HRC fuse link, gG
OFAA00H125-H20	1SCA022296R9730	12	HRC fuse link, gG
OFAA00H16	1SCA022007R4160	11	HRC fuse link, gG
OFAA00H16-H20	1SCA022296R9900	12	HRC fuse link, gG
OFAA00H2	1SCA022041R3630	11	HRC fuse link, gG
OFAA00H20	1SCA022007R4240	11	HRC fuse link, gG
OFAA00H20-H20	1SCA022297R0310	12	HRC fuse link, gG
OFAA00H25	1SCA022007R4320	11	HRC fuse link, gG
OFAA00H25-H20	1SCA022297R0580	12	HRC fuse link, gG
OFAA00H2-H20	1SCA022297R0150	12	HRC fuse link, gG
OFAA00H32	1SCA022208R7050	11	HRC fuse link, gG
OFAA00H32-H20	1SCA022297R0740	12	HRC fuse link, gG
OFAA00H35	1SCA022007R4410	11	HRC fuse link, gG
OFAA00H35-H20	1SCA022297R0910	12	HRC fuse link, gG
OFAA00H4	1SCA022028R5700	11	HRC fuse link, gG
OFAA00H40	1SCA022261R7200	11	HRC fuse link, gG
OFAA00H40-H20	1SCA022297R1390	12	HRC fuse link, gG
OFAA00H4-H20	1SCA022297R1120	12	HRC fuse link, gG
OFAA00H50	1SCA022007R4590	11	HRC fuse link, gG
OFAA00H50-H20	1SCA022297R1550	12	HRC fuse link, gG
OFAA00H6	1SCA022007R3940	11	HRC fuse link, gG
OFAA00H63	1SCA022007R4670	11	HRC fuse link, gG
OFAA00H63-H20	1SCA022297R1980	12	HRC fuse link, gG
OFAA00H6-H20	1SCA022297R1710	12	HRC fuse link, gG
OFAA00H80	1SCA022007R4750	11	HRC fuse link, gG
OFAA00H80-H20	1SCA022297R2100	12	HRC fuse link, gG
OFAA00GG10	1SCA022703R1370	9	HRC fuse link, gG
OFAA00GG100	1SCA022703R2340	9	HRC fuse link, gG
OFAA00GG125	1SCA022703R2420	9	HRC fuse link, gG
OFAA00GG16	1SCA022703R1450	9	HRC fuse link, gG
OFAA00GG160	1SCA022703R2510	9	HRC fuse link, gG
OFAA00GG20	1SCA022703R1530	9	HRC fuse link, gG
OFAA00GG25	1SCA022703R1610	9	HRC fuse link, gG

Type	Order number	Page	Description
OFAA00GG32	1SCA022703R1700	9	HRC fuse link, gG
OFAA00GG35	1SCA022703R1880	9	HRC fuse link, gG
OFAA00GG40	1SCA022703R1960	9	HRC fuse link, gG
OFAA00GG50	1SCA022703R2000	9	HRC fuse link, gG
OFAA00GG6	1SCA022703R1290	9	HRC fuse link, gG
OFAA00GG63	1SCA022703R2180	9	HRC fuse link, gG
OFAA00GG80	1SCA022703R2260	9	HRC fuse link, gG
OFAA1AM100	1SCA022701R2310	16	HRC fuse link, aM
OFAA1AM125	1SCA022701R2400	16	HRC fuse link, aM
OFAA1AM160	1SCA022701R2580	16	HRC fuse link, aM
OFAA1AM200	1SCA022701R2660	16	HRC fuse link, aM
OFAA1AM250	1SCA022701R2740	16	HRC fuse link, aM
OFAA1AM50	1SCA022701R2070	16	HRC fuse link, aM
OFAA1AM63	1SCA022701R2150	16	HRC fuse link, aM
OFAA1AM80	1SCA022701R2230	16	HRC fuse link, aM
OFAA1GG100	1SCA022700R9950	9	HRC fuse link, gG
OFAA1GG125	1SCA022701R0020	9	HRC fuse link, gG
OFAA1GG16	1SCA022703R2690	9	HRC fuse link, gG
OFAA1GG160	1SCA022701R0110	9	HRC fuse link, gG
OFAA1GG20	1SCA022703R2770	9	HRC fuse link, gG
OFAA1GG200	1SCA022701R0290	9	HRC fuse link, gG
OFAA1GG25	1SCA022703R2850	9	HRC fuse link, gG
OFAA1GG250	1SCA022701R0370	9	HRC fuse link, gG
OFAA1GG32	1SCA022703R2930	9	HRC fuse link, gG
OFAA1GG35	1SCA022703R3070	9	HRC fuse link, gG
OFAA1GG40	1SCA022703R3150	9	HRC fuse link, gG
OFAA1GG50	1SCA022700R9610	9	HRC fuse link, gG
OFAA1GG63	1SCA022700R9790	9	HRC fuse link, gG
OFAA1GG80	1SCA022700R9870	9	HRC fuse link, gG
OFAA1H100	1SCA022007R5300	11	HRC fuse link, gG
OFAA1H100-H20	1SCA022297R2520	12	HRC fuse link, gG
OFAA1H125	1SCA022007R5480	11	HRC fuse link, gG
OFAA1H125-H20	1SCA022297R2790	12	HRC fuse link, gG
OFAA1H16	1SCA022023R9510	11	HRC fuse link, gG
OFAA1H160	1SCA022007R5560	11	HRC fuse link, gG
OFAA1H160-H20	1SCA022297R3170	12	HRC fuse link, gG
OFAA1H16-H20	1SCA022297R2950	12	HRC fuse link, gG
OFAA1H20	1SCA022023R9690	11	HRC fuse link, gG
OFAA1H200	1SCA022007R5640	11	HRC fuse link, gG
OFAA1H200-H20	1SCA022297R3500	12	HRC fuse link, gG
OFAA1H20-H20	1SCA022297R3330	12	HRC fuse link, gG
OFAA1H25	1SCA022023R9770	11	HRC fuse link, gG
OFAA1H250	1SCA022007R5720	11	HRC fuse link, gG
OFAA1H250-H20	1SCA022297R3920	12	HRC fuse link, gG
OFAA1H25-H20	1SCA022297R3760	12	HRC fuse link, gG
OFAA1H32	1SCA022197R1420	11	HRC fuse link, gG
OFAA1H32-H20	1SCA022297R4140	12	HRC fuse link, gG
OFAA1H35	1SCA022007R4910	11	HRC fuse link, gG
OFAA1H35-H20	1SCA022297R4310	12	HRC fuse link, gG
OFAA1H40	1SCA022197R1690	11	HRC fuse link, gG
OFAA1H40-H20	1SCA022297R4570	12	HRC fuse link, gG
OFAA1H50	1SCA022007R5050	11	HRC fuse link, gG
OFAA1H50-H20	1SCA022297R4730	12	HRC fuse link, gG
OFAA1H63	1SCA022007R5130	11	HRC fuse link, gG
OFAA1H63-H20	1SCA022299R4410	12	HRC fuse link, gG
OFAA1H80	1SCA022007R5210	11	HRC fuse link, gG
OFAA1H80-H20	1SCA022299R4680	12	HRC fuse link, gG
OFAA2AM125	1SCA022701R2820	16	HRC fuse link, aM
OFAA2AM160	1SCA022701R2910	16	HRC fuse link, aM
OFAA2AM200	1SCA022701R3040	16	HRC fuse link, aM
OFAA2AM250	1SCA022701R3120	16	HRC fuse link, aM
OFAA2AM315	1SCA022701R3210	16	HRC fuse link, aM
OFAA2AM355	1SCA022701R3390	16	HRC fuse link, aM
OFAA2AM400	1SCA022701R3470	16	HRC fuse link, aM
OFAA2GG100	1SCA022703R3820	10	HRC fuse link, gG
OFAA2GG125	1SCA022701R0450	10	HRC fuse link, gG
OFAA2GG160	1SCA022701R0530	10	HRC fuse link, gG

Type	Order number	Page	Description
OFAA2GG200	1SCA022701R0610	10	HRC fuse link, gG
OFAA2GG224	1SCA022703R3910	10	HRC fuse link, gG
OFAA2GG250	1SCA022701R0700	10	HRC fuse link, gG
OFAA2GG300	1SCA022703R4040	10	HRC fuse link, gG
OFAA2GG315	1SCA022701R0880	10	HRC fuse link, gG
OFAA2GG32	1SCA022703R3230	10	HRC fuse link, gG
OFAA2GG35	1SCA022703R3310	10	HRC fuse link, gG
OFAA2GG355	1SCA022701R0960	10	HRC fuse link, gG
OFAA2GG40	1SCA022703R3400	10	HRC fuse link, gG
OFAA2GG50	1SCA022703R3580	10	HRC fuse link, gG
OFAA2GG63	1SCA022703R3660	10	HRC fuse link, gG
OFAA2GG80	1SCA022703R3740	10	HRC fuse link, gG
OFAA2H160	1SCA022007R5810	11	HRC fuse link, gG
OFAA2H160-H20	1SCA022299R4840	12	HRC fuse link, gG
OFAA2H200	1SCA022007R5990	11	HRC fuse link, gG
OFAA2H200-H20	1SCA022299R5060	12	HRC fuse link, gG
OFAA2H250	1SCA022007R6020	11	HRC fuse link, gG
OFAA2H250-H20	1SCA022299R5220	12	HRC fuse link, gG
OFAA2H315	1SCA022007R6110	11	HRC fuse link, gG
OFAA2H315-H20	1SCA022299R5490	12	HRC fuse link, gG
OFAA2H400	1SCA022007R6290	11	HRC fuse link, gG
OFAA2H400-H20	1SCA022299R5650	12	HRC fuse link, gG
OFAA3AM315	1SCA022701R3550	16	HRC fuse link, aM
OFAA3AM355	1SCA022701R3630	16	HRC fuse link, aM
OFAA3AM400	1SCA022701R3710	16	HRC fuse link, aM
OFAA3AM500	1SCA022701R3800	16	HRC fuse link, aM
OFAA3GG250	1SCA022703R4120	10	HRC fuse link, gG
OFAA3GG300	1SCA022703R4210	10	HRC fuse link, gG
OFAA3GG315	1SCA022701R1000	10	HRC fuse link, gG
OFAA3GG355	1SCA022701R1180	10	HRC fuse link, gG
OFAA3GG400	1SCA022701R1260	10	HRC fuse link, gG
OFAA3GG425	1SCA022706R4030	10	HRC fuse link, gG
OFAA3GG500	1SCA022701R1340	10	HRC fuse link, gG
OFAA3H315	1SCA022007R6370	11	HRC fuse link, gG
OFAA3H315-H20	1SCA022299R5810	12	HRC fuse link, gG
OFAA3H400	1SCA022007R6450	11	HRC fuse link, gG
OFAA3H400-H20	1SCA022299R6030	12	HRC fuse link, gG
OFAA3H500	1SCA022007R6530	11	HRC fuse link, gG
OFAA3H500-H20	1SCA022299R6200	12	HRC fuse link, gG
OFAA3H630	1SCA022007R6610	11	HRC fuse link, gG
OFAA3H630-H20	1SCA022299R6460	12	HRC fuse link, gG
OFAA4AAM1000	1SCA022703R4550	16	HRC fuse link, aM
OFAA4AAM500	1SCA022701R4280	16	HRC fuse link, aM
OFAA4AAM630	1SCA022701R4360	16	HRC fuse link, aM
OFAA4AAM800	1SCA022701R4440	16	HRC fuse link, aM
OFAA4AGG1000	1SCA022699R6360	10	HRC fuse link, gG
OFAA4AGG500	1SCA022660R9770	10	HRC fuse link, gG
OFAA4AGG630	1SCA022660R9850	10	HRC fuse link, gG
OFAA4AGG800	1SCA022660R9930	10	HRC fuse link, gG
OFAA4AM1000	1SCA022776R1000	16	HRC fuse link, aM
OFAA4AM500	1SCA022701R3980	16	HRC fuse link, aM
OFAA4AM630	1SCA022701R4010	16	HRC fuse link, aM
OFAA4AM800	1SCA022701R4100	16	HRC fuse link, aM
OFAA4GG1000	1SCA112679R1001	10	HRC fuse link, gG
OFAA4GG500	1SCA022701R1420	10	HRC fuse link, gG
OFAA4GG630	1SCA022701R1510	10	HRC fuse link, gG
OFAA4GG800	1SCA022701R1690	10	HRC fuse link, gG
OFAA5GG1250	1SCA112680R1001	8	HRC fuse link, gG
OFAA5GG1250	1SCA112680R1001	10	HRC fuse link, gG
OFAA5GG1600	1SCA112681R1001	8	HRC fuse link, gG
OFAA5GG1600	1SCA112681R1001	10	HRC fuse link, gG
OFAE504	1SCA022007R6880	18	Fuse replacement handle
OFAE505	2CMA125276R1000	18	Fuse replacement handle
OFAF000AM10	1SCA022652R0610	13	HRC fuse link, aM
OFAF000AM16	1SCA022652R0790	13	HRC fuse link, aM
OFAF000AM2	1SCA022652R0360	13	HRC fuse link, aM
OFAF000AM20	1SCA022652R0870	13	HRC fuse link, aM

Type	Order number	Page	Description
OFAF000AM25	1SCA022652R0950	13	HRC fuse link, aM
OFAF000AM32	1SCA022652R1090	13	HRC fuse link, aM
OFAF000AM35	1SCA022697R2510	13	HRC fuse link, aM
OFAF000AM4	1SCA022652R0440	13	HRC fuse link, aM
OFAF000AM40	1SCA022652R1170	13	HRC fuse link, aM
OFAF000AM50	1SCA022697R2690	13	HRC fuse link, aM
OFAF000AM6	1SCA022652R0520	13	HRC fuse link, aM
OFAF000AM63	1SCA022697R2770	13	HRC fuse link, aM
OFAF000AM80	1SCA022697R2850	13	HRC fuse link, aM
OFAF000H10	1SCA022627R0580	7	HRC fuse link, gG
OFAF000H100	1SCA022627R1550	7	HRC fuse link, gG
OFAF000H16	1SCA022627R0660	7	HRC fuse link, gG
OFAF000H2	1SCA022627R0230	7	HRC fuse link, gG
OFAF000H20	1SCA022627R0740	7	HRC fuse link, gG
OFAF000H25	1SCA022627R0820	7	HRC fuse link, gG
OFAF000H32	1SCA022627R0910	7	HRC fuse link, gG
OFAF000H35	1SCA022627R1040	7	HRC fuse link, gG
OFAF000H4	1SCA022627R0310	7	HRC fuse link, gG
OFAF000H40	1SCA022627R1120	7	HRC fuse link, gG
OFAF000H50	1SCA022627R1210	7	HRC fuse link, gG
OFAF000H6	1SCA022627R0400	7	HRC fuse link, gG
OFAF000H63	1SCA022627R1390	7	HRC fuse link, gG
OFAF000H80	1SCA022627R1470	7	HRC fuse link, gG
OFAF00AM100	1SCA022697R2930	13	HRC fuse link, aM
OFAF00AM125	1SCA022697R3070	13	HRC fuse link, aM
OFAF00AM160	1SCA022697R3150	13	HRC fuse link, aM
OFAF00H125	1SCA022627R1630	7	HRC fuse link, gG
OFAF00H160	1SCA022627R1710	7	HRC fuse link, gG
OFAF0AM10	1SCA022697R3310	13	HRC fuse link, aM
OFAF0AM100	1SCA022697R5790	13	HRC fuse link, aM
OFAF0AM125	1SCA022697R6090	13	HRC fuse link, aM
OFAF0AM16	1SCA022697R3400	13	HRC fuse link, aM
OFAF0AM160	1SCA022697R6170	13	HRC fuse link, aM
OFAF0AM20	1SCA022697R3580	13	HRC fuse link, aM
OFAF0AM200	1SCA022697R6250	13	HRC fuse link, aM
OFAF0AM25	1SCA022697R3660	13	HRC fuse link, aM
OFAF0AM32	1SCA022697R3740	13	HRC fuse link, aM
OFAF0AM35	1SCA022697R3820	13	HRC fuse link, aM
OFAF0AM40	1SCA022697R3910	13	HRC fuse link, aM
OFAF0AM50	1SCA022697R4040	13	HRC fuse link, aM
OFAF0AM6	1SCA022697R3230	13	HRC fuse link, aM
OFAF0AM63	1SCA022697R5610	13	HRC fuse link, aM
OFAF0AM80	1SCA022697R5950	13	HRC fuse link, aM
OFAF0H10	1SCA022627R1980	7	HRC fuse link, gG
OFAF0H100	1SCA022627R2950	7	HRC fuse link, gG
OFAF0H125	1SCA022627R3090	7	HRC fuse link, gG
OFAF0H16	1SCA022627R2010	7	HRC fuse link, gG
OFAF0H160	1SCA022627R3170	7	HRC fuse link, gG
OFAF0H20	1SCA022627R2100	7	HRC fuse link, gG
OFAF0H200	1SCA022629R5140	7	HRC fuse link, gG
OFAF0H224	1SCA022629R5220	7	HRC fuse link, gG
OFAF0H25	1SCA022627R2280	7	HRC fuse link, gG
OFAF0H250	1SCA022629R5310	7	HRC fuse link, gG
OFAF0H32	1SCA022627R2360	7	HRC fuse link, gG
OFAF0H35	1SCA022627R2440	7	HRC fuse link, gG
OFAF0H40	1SCA022627R2520	7	HRC fuse link, gG
OFAF0H50	1SCA022627R2610	7	HRC fuse link, gG
OFAF0H6	1SCA022627R1800	7	HRC fuse link, gG
OFAF0H63	1SCA022627R2790	7	HRC fuse link, gG
OFAF0H80	1SCA022627R2870	7	HRC fuse link, gG
OFAF1AM100	1SCA022697R7220	13	HRC fuse link, aM
OFAF1AM16	1SCA022697R6330	13	HRC fuse link, aM
OFAF1AM160	1SCA022697R7490	13	HRC fuse link, aM
OFAF1AM20	1SCA022697R6410	13	HRC fuse link, aM
OFAF1AM200	1SCA022697R7570	13	HRC fuse link, aM
OFAF1AM224	1SCA022697R7650	13	HRC fuse link, aM
OFAF1AM25	1SCA022697R6500	13	HRC fuse link, aM



Index

Type	Order number	Page	Description
OFAF1AM250	1SCA022697R7730	13	HRC fuse link, aM
OFAF1AM315	1SCA022697R7810	13	HRC fuse link, aM
OFAF1AM32	1SCA022697R6680	13	HRC fuse link, aM
OFAF1AM35	1SCA022697R6760	13	HRC fuse link, aM
OFAF1AM40	1SCA022697R6840	13	HRC fuse link, aM
OFAF1AM50	1SCA022697R6920	13	HRC fuse link, aM
OFAF1AM63	1SCA022697R7060	13	HRC fuse link, aM
OFAF1AM80	1SCA022697R7140	13	HRC fuse link, aM
OFAF1H100	1SCA022627R4140	7	HRC fuse link, gG
OFAF1H125	1SCA022627R4220	7	HRC fuse link, gG
OFAF1H16	1SCA022627R3250	7	HRC fuse link, gG
OFAF1H160	1SCA022627R4310	7	HRC fuse link, gG
OFAF1H20	1SCA022627R3330	7	HRC fuse link, gG
OFAF1H200	1SCA022627R4490	7	HRC fuse link, gG
OFAF1H224	1SCA022627R4570	7	HRC fuse link, gG
OFAF1H25	1SCA022627R3410	7	HRC fuse link, gG
OFAF1H250	1SCA022627R4650	7	HRC fuse link, gG
OFAF1H315	1SCA022627R4730	7	HRC fuse link, gG
OFAF1H32	1SCA022627R3500	7	HRC fuse link, gG
OFAF1H35	1SCA022627R3680	7	HRC fuse link, gG
OFAF1H355	1SCA022701R4520	7	HRC fuse link, gG
OFAF1H40	1SCA022627R3760	7	HRC fuse link, gG
OFAF1H50	1SCA022627R3840	7	HRC fuse link, gG
OFAF1H63	1SCA022627R3920	7	HRC fuse link, gG
OFAF1H80	1SCA022627R4060	7	HRC fuse link, gG
OFAF2AM100	1SCA022697R8620	14	HRC fuse link, aM
OFAF2AM125	1SCA022697R8710	14	HRC fuse link, aM
OFAF2AM160	1SCA022697R8890	14	HRC fuse link, aM
OFAF2AM200	1SCA022697R8970	14	HRC fuse link, aM
OFAF2AM224	1SCA022697R9010	14	HRC fuse link, aM
OFAF2AM250	1SCA022697R9190	14	HRC fuse link, aM
OFAF2AM300	1SCA022697R9270	14	HRC fuse link, aM
OFAF2AM315	1SCA022697R9350	14	HRC fuse link, aM
OFAF2AM35	1SCA022697R8110	14	HRC fuse link, aM
OFAF2AM355	1SCA022697R9430	14	HRC fuse link, aM
OFAF2AM40	1SCA022697R8200	14	HRC fuse link, aM
OFAF2AM400	1SCA022697R9510	14	HRC fuse link, aM
OFAF2AM50	1SCA022697R8380	14	HRC fuse link, aM
OFAF2AM500	1SCA022697R9600	14	HRC fuse link, aM
OFAF2AM63	1SCA022697R8460	14	HRC fuse link, aM
OFAF2AM80	1SCA022697R8540	14	HRC fuse link, aM
OFAF2H100	1SCA022627R5380	8	HRC fuse link, gG
OFAF2H125	1SCA022627R5460	8	HRC fuse link, gG
OFAF2H160	1SCA022627R5540	8	HRC fuse link, gG
OFAF2H200	1SCA022627R5620	8	HRC fuse link, gG
OFAF2H224	1SCA022627R5710	8	HRC fuse link, gG
OFAF2H25	1SCA115948R1001	8	HRC fuse link, gG
OFAF2H250	1SCA022627R5890	8	HRC fuse link, gG
OFAF2H300	1SCA022627R5970	8	HRC fuse link, gG
OFAF2H315	1SCA022627R6010	8	HRC fuse link, gG
OFAF2H35	1SCA022627R4810	8	HRC fuse link, gG
OFAF2H355	1SCA022627R6190	8	HRC fuse link, gG
OFAF2H40	1SCA022627R4900	8	HRC fuse link, gG
OFAF2H400	1SCA022627R6270	8	HRC fuse link, gG
OFAF2H425	1SCA022706R3900	8	HRC fuse link, gG
OFAF2H50	1SCA022627R5030	8	HRC fuse link, gG
OFAF2H500	1SCA022701R4610	8	HRC fuse link, gG
OFAF2H63	1SCA022627R5110	8	HRC fuse link, gG
OFAF2H80	1SCA022627R5200	8	HRC fuse link, gG
OFAF3AM250	1SCA022697R9780	14	HRC fuse link, aM
OFAF3AM300	1SCA022697R9860	14	HRC fuse link, aM
OFAF3AM315	1SCA022697R9940	14	HRC fuse link, aM
OFAF3AM355	1SCA022698R0010	14	HRC fuse link, aM
OFAF3AM400	1SCA022698R0100	14	HRC fuse link, aM
OFAF3AM425	1SCA022698R0280	14	HRC fuse link, aM
OFAF3AM500	1SCA022698R0440	14	HRC fuse link, aM
OFAF3AM630	1SCA022698R0520	14	HRC fuse link, aM

Type	Order number	Page	Description
OFAF3AM800	1SCA022701R4790	14	HRC fuse link, aM
OFAF3AN450	1SCA022698R0360	14	HRC fuse link, aM
OFAF3H250	1SCA022627R6350	8	HRC fuse link, gG
OFAF3H300	1SCA022627R6430	8	HRC fuse link, gG
OFAF3H315	1SCA022627R6510	8	HRC fuse link, gG
OFAF3H355	1SCA022627R6600	8	HRC fuse link, gG
OFAF3H400	1SCA022627R6780	8	HRC fuse link, gG
OFAF3H425	1SCA022627R6860	8	HRC fuse link, gG
OFAF3H450	1SCA022627R6940	8	HRC fuse link, gG
OFAF3H500	1SCA022627R7080	8	HRC fuse link, gG
OFAF3H630	1SCA022627R7160	8	HRC fuse link, gG
OFAF3H800	1SCA022627R7240	8	HRC fuse link, gG
OFAF4AAM1000	1SCA022698R1840	14	HRC fuse link, aM
OFAF4AAM1250	1SCA022698R1920	14	HRC fuse link, aM
OFAF4AAM500	1SCA022698R1410	14	HRC fuse link, aM
OFAF4AAM630	1SCA022698R1680	14	HRC fuse link, aM
OFAF4AAM800	1SCA022698R1760	14	HRC fuse link, aM
OFAF4AH1000	1SCA022637R4280	8	HRC fuse link, gG
OFAF4AH1250	1SCA022637R4360	8	HRC fuse link, gG
OFAF4AH500	1SCA022637R3980	8	HRC fuse link, gG
OFAF4AH630	1SCA022637R4010	8	HRC fuse link, gG
OFAF4AH800	1SCA022637R4100	8	HRC fuse link, gG
OFAF4AM1000	1SCA022698R1090	14	HRC fuse link, aM
OFAF4AM1250	1SCA022698R1170	14	HRC fuse link, aM
OFAF4AM400	1SCA022698R0610	14	HRC fuse link, aM
OFAF4AM500	1SCA022698R0790	14	HRC fuse link, aM
OFAF4AM630	1SCA022698R0870	14	HRC fuse link, aM
OFAF4AM800	1SCA022698R0950	14	HRC fuse link, aM
OFAF4H1000	1SCA022627R7750	8	HRC fuse link, gG
OFAF4H1250	1SCA022627R7830	8	HRC fuse link, gG
OFAF4H400	1SCA022627R7320	8	HRC fuse link, gG
OFAF4H500	1SCA022627R7410	8	HRC fuse link, gG
OFAF4H630	1SCA022627R7590	8	HRC fuse link, gG
OFAF4H800	1SCA022627R7670	8	HRC fuse link, gG
OFAM00AM10	1SCA022386R2800	15	HRC fuse link, aM
OFAM00AM100	1SCA022324R8610	15	HRC fuse link, aM
OFAM00AM100-H20	1SCA022339R5080	17	HRC fuse link, aM
OFAM00AM10-H20	1SCA022386R7430	17	HRC fuse link, aM
OFAM00AM125	1SCA022324R8880	15	HRC fuse link, aM
OFAM00AM125-H20	1SCA022339R5240	17	HRC fuse link, aM
OFAM00AM16	1SCA022323R6520	15	HRC fuse link, aM
OFAM00AM160	1SCA022324R9000	15	HRC fuse link, aM
OFAM00AM160	1SCA022324R9000	16	HRC fuse link, aM
OFAM00AM160-H20	1SCA022339R5410	17	HRC fuse link, aM
OFAM00AM16-H20	1SCA022339R3460	17	HRC fuse link, aM
OFAM00AM2	1SCA022640R4960	15	HRC fuse link, aM
OFAM00AM20	1SCA022323R6790	15	HRC fuse link, aM
OFAM00AM20-H20	1SCA022339R3620	17	HRC fuse link, aM
OFAM00AM25	1SCA022324R2410	15	HRC fuse link, aM
OFAM00AM25-H20	1SCA022339R3890	17	HRC fuse link, aM
OFAM00AM2-H20	1SCA022640R5000	17	HRC fuse link, aM
OFAM00AM32	1SCA022324R2680	15	HRC fuse link, aM
OFAM00AM32-H20	1SCA022339R4010	17	HRC fuse link, aM
OFAM00AM4	1SCA022386R2630	15	HRC fuse link, aM
OFAM00AM40	1SCA022324R2840	15	HRC fuse link, aM
OFAM00AM40-H20	1SCA022339R4270	17	HRC fuse link, aM
OFAM00AM4-H20	1SCA022386R7270	17	HRC fuse link, aM
OFAM00AM50	1SCA022324R2500	15	HRC fuse link, aM
OFAM00AM50-H20	1SCA022339R4430	17	HRC fuse link, aM
OFAM00AM6	1SCA022386R2710	15	HRC fuse link, aM
OFAM00AM63	1SCA022324R2760	15	HRC fuse link, aM
OFAM00AM63-H20	1SCA022339R4600	17	HRC fuse link, aM
OFAM00AM6-H20	1SCA022386R7350	17	HRC fuse link, aM
OFAM00AM80	1SCA022324R2920	15	HRC fuse link, aM
OFAM00AM80-H20	1SCA022339R4860	17	HRC fuse link, aM
OFAM1AM100	1SCA022194R6740	15	HRC fuse link, aM
OFAM1AM100-H20	1SCA022299R6620	17	HRC fuse link, aM

Contact us

ABB Oy

Low Voltage Switches

P.O. Box 622

FI-65101 Vaasa, Finland

Phone: +358 10 22 11

Fax: +358 10 22 45708

E-Mail: firstname.surname@fi.abb.com

www.abb.com

The technical data and dimensions are valid at the time of printing. We reserve the right to subsequent alterations.

Catalogue OF1GB 10-04, 1SCC317001C0201

Produced by A&V Insinööri Oy / Tekninen viestintä, Vaasa, Finland

Power and productivity
for a better world™

