

Flexible Counter Series in DIN size 36 x 72 mm

tico 734



MODEL OVERVIEW





Programmable Rate Meter (0 734 004)

4 digit, scale multiplier 0.001 to 9999,
decimal point
magnetic input for measurement
system not requiring external power

- LCD display, 8 digits, 12 mm height, excellent contrast through
- Backlighting with a 10-28 VDC supply
- Lithium battery power supply
- Decimal point, input scaling, count direction, output mode, etc. programmable, depending on model
- Programming reduced to a minimum for easy handling and set-up
- CE approval, IP 65, NEMA 4
- Suitable for TTL
- Mounting depth 29 mm

The family **tico 734** consists of ten models:

- 0 734 000 Totalizer without scaling
- 0 734 001 Add/Subtract totalizer
- 0 734 002 Position indicator
- 0 734 003 Tachometer
- 0 734 004 Programmable rate meter
- 0 734 005 Rate meter with totalizer
- 0 734 006 Time counter
- 0 734 007 Preset counter
- 0 734 008 Time preset counter
- 0 734 009 Rate meter 005; with total and pulsed output

Input  10kHz — 4	5 — Progr. 	4 Input A, 10 kHz, Mag.
Input  30 Hz — 3	6 NC	3 Input A, 30 Hz, NPN
Input  10kHz — 2	7 NC	2 Input A, 10 kHz, PNP
0V — 1	8 — 10-28 VDC	1 0V, Common
		5 Program enable
		6 Not used
		7 Not used
Suitable option modules: 1 734 0.. 10, 12, 14, 17, 19		8 DC-supply for backlighting

tico 734

Technical data

Power Supply

Internal	Single or dual lithium 3 V battery (CR 1/2 AA), typical life time of 5 years (10 yrs w/2 batteries). „Lo BAT" display flashes approximately 2 weeks prior to end of battery life. Models w/SSR: battery life approx. 6 months (50 % duty cycle) can be extended to 5 years with option module
via Option Module	120/240 VAC provides 12 VDC for display backlighting and reduces battery load in models with SSR output

Display

Display	LCD, 12 mm height, 8 digits for counters, 4 digits (plus dummy zero) for tacho and rate meters, 6 digits timer
Backlighting	Whole display area can be backlit with a 10-28 VDC supply, green-yellow colour

Count Inputs

High Speed Input (2)	PNP, ≤ 28 VDC, max. 10 kHz (50 % duty cycle), Low < 1.0 V, High > 2.0 V, impulse > 45 μ s, impedance 1 M Ω
Low Speed Input (3)	NPN, ≤ 28 VDC, max. 30 Hz (50 % duty cycle), Low < 1.0 V, High > 2.0 V, impedance 1 M Ω

Magnet- input

High Voltage Option Module	100..260 VAC/DC, 30 Hz, 1 M Ω , with internal connection to input (3)
Low Voltage Option Module	5..30 VAC/DC, 30 Hz, 17 k Ω , with internal connection to input (3)

Control Inputs

Enable Input (5)	NPN, ≤ 28 VDC, level sensitive
Reset Input (4)	NPN, ≤ 28 VDC, edge triggered, max. 30 Hz (50 % duty cycle)

Output (only 009)

SSR Relay	Photomos relay, 0.1 A, 30 VAC/DC, reaction time < 5 ms
-----------	--

Physical

Relay Option Module	Changeover contact 5 A, 120/240 VAC or 30 VDC
Mounting	Front panel mounting with mounting bracket
Dimensions	DIN 36 x 72 mm, 36 mm total depth, total width 83 mm
Panel Cutout	33 $^{+0.3}$ mm x 68 $^{+0.3}$ mm, depth behind panel < 29 mm
Panel Thickness	max. 8 mm

Environmental

Front Panel Rating	IP 65 / NEMA 4
Operating and Storage Temperature	0 °C to + 55 °C - 20 °C to + 60 °C
General	DIN EN 61010 part 1 / VDE 0411 part 1 Protection according to class II, Contamination level 2 Overvoltage category II

DIMENSIONS

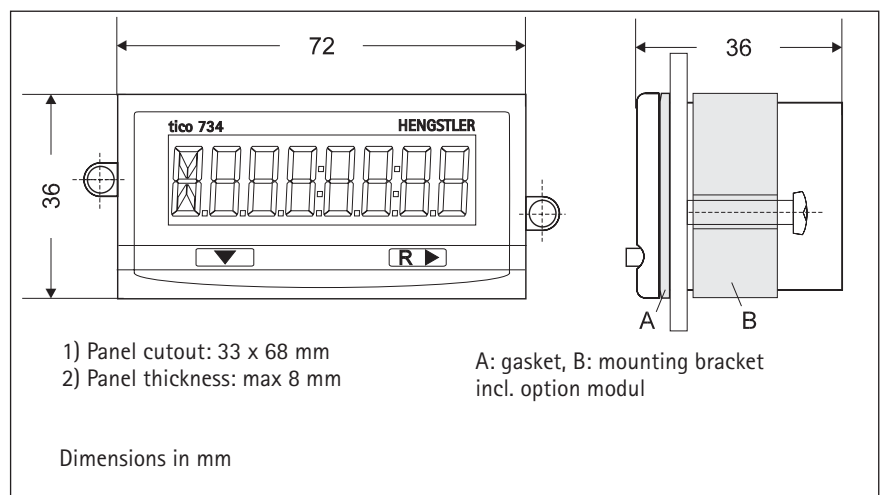

OPTION MODULES

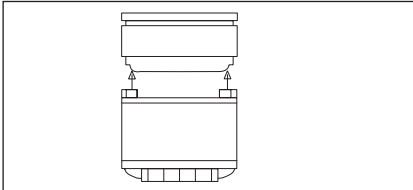

FUNCTIONS OVERVIEW

TECHNICAL DATA

WIRING

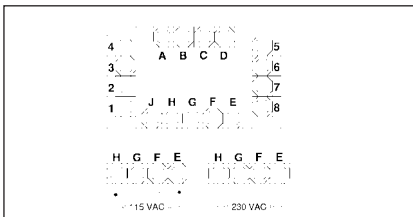

ORDERING INFORMATION

With the Option Modules, the **tico 734** can be functionally extended and adapted to special application conditions. The following option functions are available:

- AC power supply providing sensor supply 10-20 VDC / 50 mA and 12 V supply for display backlighting (supports the battery in models with SSR output)
- Relay output, changeover contact, 5 A, 120/240 VAC or 30 VDC
- High voltage input (100..260 VAC/DC, max. 30 Hz, 200 KΩ)

1734 ...

Connections 010 011 012 013 014 015 016 017 018 019 020

High Voltage Input	C-D	x		x	x		x			
Relay 1 x change over	A-B-J		x	x		x	x		x	x
AC power Supply	E-F, G-H			x		x	x			x x
Low Voltage Input	C-D							x	x	x x

Power Supply (E-H)	115 VAC or 230 VAC (see wiring), frequency 50/60 Hz. Terminal (8) provides an unregulated 10-20 VDC supply for powering sensors up to 50 mA
Relay	Type: SPDT (Form C) mechanical relay; Operate Time: 6 ms
Output (A-B-J)	5A, 120/240 VAC or 30 VDC, silver alloy Electrical Life: > 500 000 operations, Mechanical Life: > 10 million operations
High Voltage Input (C-D)	Voltage Range: 100 to 260 VAC or VDC Count Speed: max. 30 Hz. (duty cycle 50 %)
Low Voltage Input (C-D)	Voltage Range: 5 to 30 VAC or VDC Count Speed: max. 30 Hz. (duty cycle 50 %)
Input (C-D)	Minimum Pulse Width: 12 ms; Impedance: 200 kOhm
Mounting	Attaching on back of instrument
Dimensions	42 x 69 mm, depth 58 mm, total depth behind panel with instrument 82 mm
Temperature	Operating: -0° C to +50° C; Storage -20° C to +60° C;
General	DIN EN 61010 part 1, Protection according to class II Contamination level 2; Overvoltage category II

All modules contain 17 terminals. The exact functions that are present are determined by the model of instrument and option module (see Functions Overview).

1-8 Connection to instrument (refer to appropriate operating instructions)

A	Normally Open Relay Contact
B	Relay Common
J	Normally Closed Relay Contact
C-D	High or Low Voltage Input, no polarity, (provides NPN signal on terminal 3)
E-F	115 VAC Line winding I
G-H	115 VAC Line winding II

Panel Instruments

Totalizer	0 734 000
Add/Subtract Totalizer	0 734 001
Position Indicator	0 734 002
Tachometer	0 734 003
Programmable Rate Meter	0 734 004
Rate Meter with Totalizer	0 734 005
Elapsed Time Indicator	0 734 006
Preset Counter	0 734 007
Preset Timer	0 734 008
Rate Meter with Total and Pulsed Output	0 734 009
Lithiumbattery	E3533 355

Option Modules

HV Input	1 734 010
Relay	1 734 011
AC Power	1 734 012
HV Input and Relay	1 734 013
HV Input and Power	1 734 014
Power and Relay	1 734 015
HV Input/Power/Relay	1 734 016
LV Input	1 734 017
LV Input and Relay	1 734 018
LV Input and Power	1 734 019
LV Input/Power/Relay	1 734 020