

# Book-style EMC/RFI Filter for Inverters and Power Drive Systems

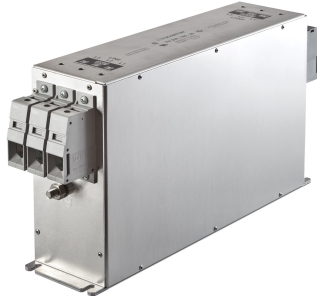

- Industry standard EMC solution for three-phase PDS filtering
- Slim space-saving book-style housing
- Solid safety connector blocks or optional wire output connections
- Excellent attenuation performance
- HV versions for up to 690 VAC
- HVIT versions for IT distribution networks
- P/L versions with low leakage current



### Performance indicators

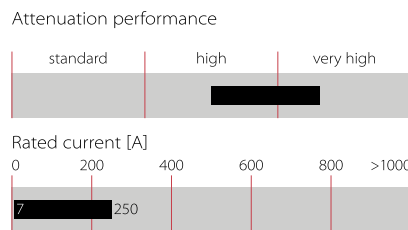

### Approvals & Compliances



UL/CSA: FN 258 up to 180 A (ex. -180-07)

### Features and benefits

- FN 258 range of filters provides state-of-the-art EMI attenuation based on an innovative multi-stage filter topology. They help to ensure compliance with Class A or even Class B limits
- The slim book-style shape allows a convenient and space-saving installation next to inverters and motor drives
- With 480 VAC rating and filter modules from 7 to 250 A, FN 258 are ready for the most diverse applications worldwide
- FN 258 HV filters up to 130 A are designed for 690 VAC distribution networks
- FN 258 HVIT filters up to 130 A meet the special requirements for the application in industrial 690 VAC IT distribution networks
- FN 258 L and FN 258 P filters help to fulfill tough requirements in respect of leakage current limitation and provide an excellent solution to overcome problems with nuisance tripping of sensitive earth leakage detectors

### Technical specifications

<b>Maximum continuous operating voltage</b>	3x 520/300 VAC (FN 258, FN 258 L, FN 258 P) 3x 760/440 VAC (FN 258 HV, FN 258 HVIT)
<b>Rated currents</b>	7 to 250 A @50°C (480 V filters)
<b>Operating frequency</b>	DC to 60 Hz
<b>High potential test voltage</b>	P -> E 2650 VDC for 2 sec (FN 258) P -> P 2100 VDC for 2 sec (FN 258) P -> E 2000 VAC for 2 sec (FN 258L) P -> P 2100 VDC for 2 sec (FN 258L) P -> E 3000 VDC for 2 sec (FN 258P) P -> P 2100 VDC for 2 sec (FN 258P) P -> E 3200 VDC for 2 sec (FN 258HV and FN 258HVIT) P -> P 3270 VDC for 2 sec (FN 258HV and FN 258HVIT)
<b>Protection category</b>	IP 20
<b>Overload capability</b>	4x rated current at switch on, 1.5x rated current for 1 minute, once per hour
<b>Temperature range (operation and storage)</b>	-25°C to +100°C (25/100/21)
<b>Flammability corresponding to</b>	UL 94 V-2 or better
<b>Design corresponding to</b>	UL 1283, CSA 22.2 No. 8 1986, IEC/EN 60939
<b>MTBF @ 50°C/400 V (Mil-HB-217F)</b>	220,000 hours

### Typical applications

- Three-phase variable speed drives and power drive systems (PDS)
- IT power distribution networks (FN 258 HVIT)
- Applications comprising energy conversion devices (inverters, converters)
- Process automation equipment
- Three-phase power supplies and UPS
- Applications with low-leakage current requirements (FN 258 L and FN 258 P)

### Typical electrical schematic

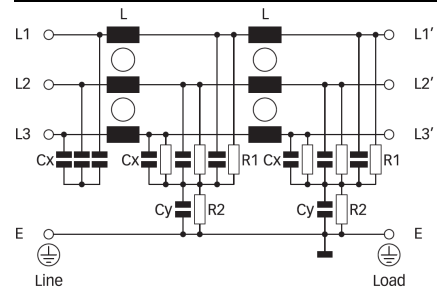

Note: HVIT versions without discharge resistor to ground.

## Filter selection table

Filter*	Rated current @ 50°C (40°C) [A]	Typical drive power rating** [kW]	Leakage current*** @ 520/760 VAC/50 Hz [mA]	Power loss @ 25°C/50 Hz [W]	Input connections	Output connections	Weight [kg]
FN 258-7-..	7 (7.7)	4	2.0	9	-29	-07	1.0
FN 258-16-..	16 (17.5)	7.5	2.1	20	-29	-07	1.4
FN 258-30-..	30 (33)	15	2.9	21	-33	-07	1.7
FN 258-42-..	42 (46)	22	3.0	30	-33	-07	2.5
FN 258-55-..	55 (60)	30	3.0	30	-34	-07	2.9
FN 258-75-34	75 (82)	37	3.0	24	-34	-34	3.9
FN 258-100-35	100 (110)	55	3.0	51	-35	-35	5.5
FN 258-130-35	130 (143)	75	3.5	50	-35	-35	6.9
FN 258-180-..	180 (197)	90	3.5	73	-40	-07	11.0
FN 258-250-..	250 (275)	132	3.4	79	-40	-07	12.0
FN 258 HV-7-29	7 (7.7)	5.5	1.6	9	-29	-29	1.0
FN 258 HV-16-29	16 (17.5)	11	2.3	20	-29	-29	1.5
FN 258 HV-30-33	30 (33)	22	2.3	21	-33	-33	1.8
FN 258 HV-42-33	42 (46)	30	2.6	30	-33	-33	2.6
FN 258 HV-55-34	55 (60)	45	2.6	30	-34	-34	3.0
FN 258 HV-75-34	75 (82)	55	2.6	24	-34	-34	4.3
FN 258 HV-100-35	100 (110)	90	2.6	51	-35	-35	5.6
FN 258 HV-130-35	130 (143)	110	2.9	50	-35	-35	7.1
FN 258 HVIT-7-29	7 (7.7)	5.5	0.1	9	-29	-29	1.0
FN 258 HVIT-16-29	16 (17.5)	11	0.1	20	-29	-29	1.5
FN 258 HVIT-30-33	30 (33)	22	0.1	21	-33	-33	1.8
FN 258 HVIT-42-33	42 (46)	30	0.1	30	-33	-33	2.6
FN 258 HVIT-55-34	55 (60)	45	2.6	30	-34	-34	3.0
FN 258 HVIT-75-34	75 (82)	55	2.6	24	-34	-34	4.3
FN 258 HVIT-100-35	100 (110)	90	2.6	51	-35	-35	5.6
FN 258 HVIT-130-35	130 (143)	110	2.9	50	-35	-35	7.1
FN 258 L-7-..	7 (7.7)	4	0.1	9	-29	-07	1.0
FN 258 L-16-..	16 (17.5)	7.5	0.1	20	-29	-07	1.4
FN 258 L-30-..	30 (33)	15	0.1	21	-33	-07	1.7
FN 258 L-42-..	42 (46)	22	0.1	30	-33	-07	2.5
FN 258 L-55-..	55 (60)	30	0.1	30	-34	-07	2.9
FN 258 L-75-34	75 (82)	37	0.1	24	-34	-34	3.9
FN 258 L-100-35	100 (110)	55	0.1	51	-35	-35	5.5
FN 258 L-130-35	130 (143)	75	0.1	50	-35	-35	6.9
FN 258 L-180-..	180 (197)	90	0.1	73	-40	-07	11.0
FN 258 L-250-07	250 (275)	132	0.1	79	-40	-07	12.0
FN 258 P-7-..	7 (7.7)	4	0.4	9	-29	-07	1.0
FN 258 P-16-..	16 (17.5)	7.5	0.4	20	-29	-07	1.4
FN 258 P-30-..	30 (33)	15	0.4	21	-33	-07	1.7
FN 258 P-42-..	42 (46)	22	0.4	30	-33	-07	2.5
FN 258 P-55-..	55 (60)	30	0.4	30	-34	-07	2.9
FN 258 P-75-34	75 (82)	37	0.4	24	-34	-34	3.9
FN 258 P-100-35	100 (110)	55	0.4	51	-35	-35	5.5
FN 258 P-130-35	130 (143)	75	0.4	50	-35	-35	6.9
FN 258 P-180-..	180 (197)	90	0.4	73	-40	-07	11.0
FN 258 P-250-07	250 (275)	132	0.4	79	-40	-07	12.0

\* To compile a complete part number, please replace the .. with the required output connection style.

\*\* Calculated at rated current, 440 VAC (FN 258)/690 VAC (FN 258 HV) and cos phi=0.8. The exact value depends upon the efficiency of the drive, the motor and the entire application.

\*\*\* Standardized calculated leakage current acc. IEC60939 under normal operating conditions (FN 258 at 520 VAC and FN 258 HV at 760 VAC).

## Typical filter attenuation

Per CISPR 17; A=50 Ω/50 Ω sym; B=50 Ω/50 Ω asym; C=0.1 Ω/100 Ω sym; D=100 Ω/0.1 Ω sym

7 to 30 A types

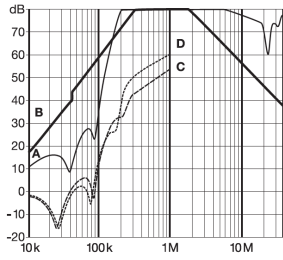

42 to 100 A types

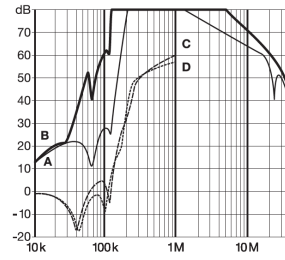

130 A types

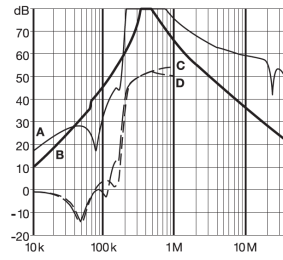

180 and 250 A types

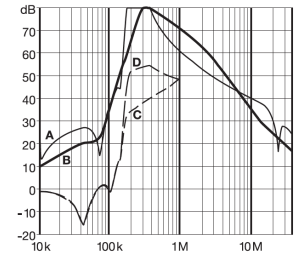

Note: typical attenuation performance of FN 258 standard filters. The behavior of FN 258 HV, FN 258 HVIT, FN 258 P and FN 258 L may be slightly different.

## Mechanical data

7 to 55 A types (-07)

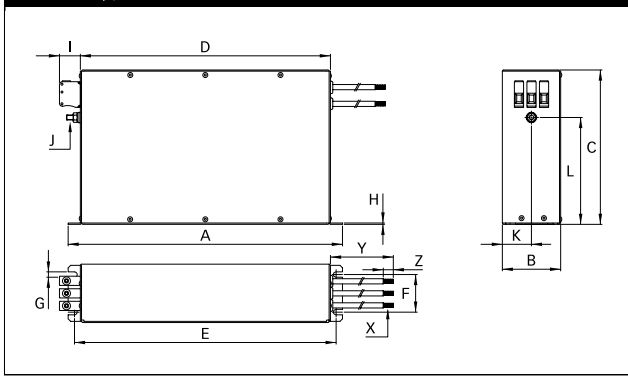

7 to 130 A types (-29, -33, -34, -35)

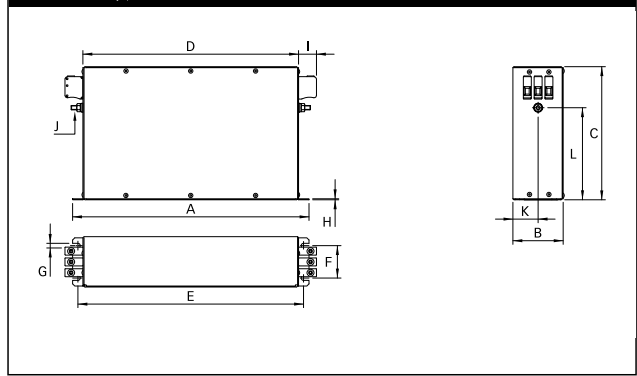

180 and 250 A types (-07)

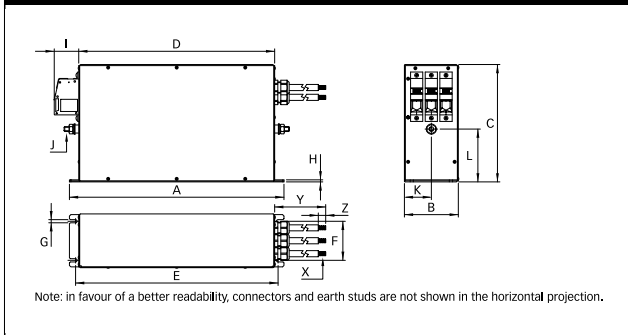

180 and 250 A types (-40)

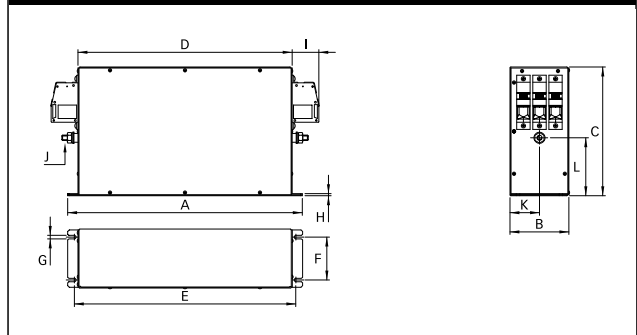





Note: in favour of a better readability, connectors and earth studs are not shown in the horizontal projection.

	7 A	16 A	30 A	42 A	55 A	75 A	100 A	130 A	180 A	250 A
<b>A</b>	255	305	335	329	329	329	379	439	438	478
<b>B</b>	50	55	60	70	80	80	90	110	110	110
<b>C</b>	126	142	150	185	185	220	220	240	240	240
<b>D</b>	225	275	305	300	300	300	350	400	400	440
<b>E</b>	240	290	320	314	314	314	364	414	413	453
<b>F</b>	25	30	35	45	55	55	65	80	80	80
<b>G</b>	6.5	6.5	6.5	6.5	6.5	6.5	6.5	6.5	6.5	6.5
<b>H</b>	1	1	1	1.5	1.5	1.5	1.5	3	4	4
<b>I</b>	10.9	10.9	25	25	39	39	45	45	51	51
<b>J</b>	M5	M5	M5	M6	M6	M6	M10	M10	M10	M10
<b>K</b>	25	27.5	30	35	40	40	45	55	55	55
<b>L</b>	85	100	110	130	105	140	130	140	110	110
<b>X*</b>	AWG 16	AWG 14	AWG 10	AWG 8	AWG 6				50 mm <sup>2</sup>	70 mm <sup>2</sup>
<b>Y*</b>	300 ±10	300 ±10	400 ±10	500 ±10	500 ±10				500 ±10	500 ±10
<b>Z*</b>	9	9	9	12	12				15	15

\* Filters with output wire connections (-07) only.  
 All dimensions in mm; 1 inch = 25.4 mm  
 Tolerances according: ISO 2768-m/EN 22768-m

### Filter input/output connector cross sections

	-29	-33	-34	-35	-40
					
<b>Solid wire</b>	6 mm <sup>2</sup>	16 mm <sup>2</sup>	35 mm <sup>2</sup>	50 mm <sup>2</sup>	95 mm <sup>2</sup>
<b>Flex wire</b>	4 mm <sup>2</sup>	10 mm <sup>2</sup>	25 mm <sup>2</sup>	50 mm <sup>2</sup>	95 mm <sup>2</sup>
<b>AWG type wire</b>	AWG 10	AWG 6	AWG 2	AWG 1/0	AWG 4/0
<b>Recommended torque</b>	0.6-0.8 Nm	1.5-1.8 Nm	4.0-4.5 Nm	7-8 Nm	17-20 Nm

Please visit [www.schaffner.com](http://www.schaffner.com) to find more details on filter connectors.



## Switzerland

### Schaffner Group

Industrie Nord  
Nordstrasse 11e  
4542 Luterbach  
T +41 32 681 66 26  
[info@schaffner.com](mailto:info@schaffner.com)

To find your local partner within Schaffner's global network: [www.schaffner.com](http://www.schaffner.com)

© 2020 Schaffner Group

The content of this document has been carefully checked and understood. However, neither Schaffner nor its subsidiaries assume any liability whatsoever for any errors or inaccuracies of this document and the consequences thereof. Published specifications are subject to change without notice. Product suitability for any area of application must ultimately be determined by the customer. In all cases, products must never be operated outside their published specifications. Schaffner does not guarantee the availability of all published products. This disclaimer shall be governed by substantive Swiss law and resulting disputes shall be settled by the courts at the place of business of Schaffner Holding AG. Latest publications and a complete disclaimer can be downloaded from the Schaffner website. All trademarks recognized.

## China

### Schaffner EMC Ltd. Shanghai

T20-3 C, No 565 Chuangye Road,  
Pudong district  
201201 Shanghai  
T +86 21 3813 9500  
[cschina@schaffner.com](mailto:cschina@schaffner.com)  
[www.schaffner.com.cn](http://www.schaffner.com.cn)

## Finland

### Schaffner Oy

Sauvonrinne 19 H  
08500 Lohja  
T +358 10 567 2855  
[finlandsales@schaffner.com](mailto:finlandsales@schaffner.com)

## France

### Schaffner EMC S.A.S.

16-20 Rue Louis Rameau  
95875 Bezons  
T +33 1 34 34 30 60  
F +33 1 39 47 02 28  
[francesales@schaffner.com](mailto:francesales@schaffner.com)

## Germany

### Schaffner Deutschland GmbH

Schoemperlenstrasse 12B  
76185 Karlsruhe  
T +49 721 56910  
F +49 721 569110  
[germanysales@schaffner.com](mailto:germanysales@schaffner.com)

## India

### Schaffner India Pvt. Ltd

REGUS WORLD TRADE CENTRE  
WTC, 22nd Floor Unit No 2238, Brigade Gateway  
Campus, 26/1, Dr. Rajkumar Road Malleshwaram  
(W)  
560055 Bangalore  
T +91 80 67935355  
[indiasales@schaffner.com](mailto:indiasales@schaffner.com)

## Italy

### Schaffner EMC S.r.l.

Via Ticino, 30  
20900 Monza (MB)  
T +39 039 21 41 070  
[italysales@schaffner.com](mailto:italysales@schaffner.com)

## Japan

### Schaffner EMC K.K.

Taiju-Seimei Sangenjaya Bldg.  
1-32-12, Kamiyama, Setagaya-ku  
154-0011 Tokyo  
T +81 3 5712 3650  
F +81 3 5712 3651  
[japansales@schaffner.com](mailto:japansales@schaffner.com)  
[www.schaffner.jp](http://www.schaffner.jp)

## Singapore

### Schaffner EMC Pte Ltd.

#05-09, Kg Ubi Ind. Estate  
408705 Singapore  
T +65 6377 3283  
F +65 6377 3281  
[singaporesales@schaffner.com](mailto:singaporesales@schaffner.com)

## Spain

### Schaffner EMC España

Calle Caléndula 93, Miniparc III, Edificio E  
El Soto de Moraleja, Alcobendas  
28109 Madrid  
T +34 917 912 900  
F +34 917 912 901  
[spainsales@schaffner.com](mailto:spainsales@schaffner.com)

## Sweden

### Schaffner EMC AB

Östermalmstorg 1  
114 42 Stockholm  
T +46 8 5050 2425  
[swedensales@schaffner.com](mailto:swedensales@schaffner.com)  
[www.schaffner.com](http://www.schaffner.com)

## Switzerland

### Schaffner EMV AG

Industrie Nord  
Nordstrasse 11e  
4542 Luterbach  
T +41 32 681 66 88  
T +41 32 681 66 26  
[switzerlandsales@schaffner.com](mailto:switzerlandsales@schaffner.com)

## Taiwan R.O.C.

### Schaffner EMV Ltd.

20 Floor-2, No 97, Section 1, XinTai 5th Road  
22175 XiZhi District New Taipei City 22175  
T +886 2 2697 5500  
F +886 2 2697 5533  
[taiwansales@schaffner.com](mailto:taiwansales@schaffner.com)  
[www.schaffner.com.tw](http://www.schaffner.com.tw)

## Thailand

### Schaffner EMC Co. Ltd.

Northern Region Industrial Estate  
67 Moo 4 Tambon Ban Klang  
Amphur Muang P.O. Box 14  
51000 Lamphun  
T +66 53 58 11 04  
F +66 53 58 10 19  
[thailandsales@schaffner.com](mailto:thailandsales@schaffner.com)

## United Kingdom

### Schaffner Ltd.

1, Oakmede Place  
Binfield  
RG42 4JF Berkshire  
T +44 118 9770070  
F +44 118 9792969  
[uksales@schaffner.com](mailto:uksales@schaffner.com)

## USA

### Schaffner EMC Inc.

52 Mayfield Avenue  
Edison, New Jersey  
T +1 732 225 9533  
F +1 732 225 4789  
[usasales@schaffner.com](mailto:usasales@schaffner.com)  
[www.schaffnerusa.com](http://www.schaffnerusa.com)

### Schaffner North America

6722 Thirlane Road  
24019 Roanoke, Virginia  
T +1 276 228 7943  
F +1 276 228 7953

### Schaffner North America

823 Fairview Road  
24382 Wytheville, Virginia  
T +1 276 228 7943  
F +1 276 228 7258