

FUJI ED & C TIMES

New Products

New α -TWIN series MCCBs and ELCBs, extended up to 800AF	2
AS-Interface analog slaves, FM6A	6
AS-Interface waterproof connector type A/B slaves, FM6DB1	8
AS-Interface dustproof connector type A/B slaves, FM4DB, FM4DB1	10
AS-Interface 7-segment display FM4DP2	12
AS-Interface addressing unit FL1HA-E	14
Arresters for signal line and control circuit, CN226 series	16
Arresters for network circuits, CN227 series	18

Modified Products

Command switches/CCC approved AH, AR/DR, AM/DM series	20
---	----

*New α -TWIN series
MCCBs and ELCBs*

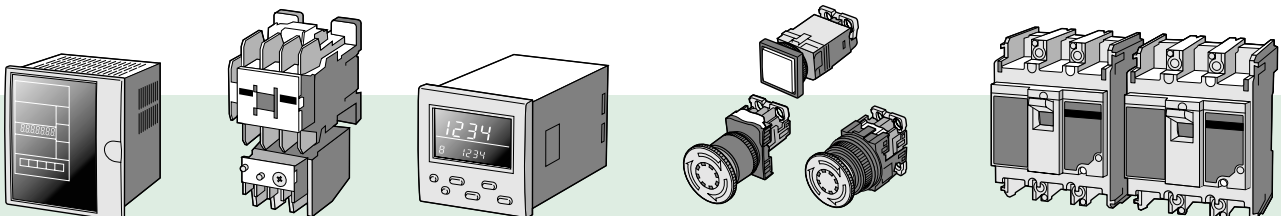

New α -TWIN series MCCBs and ELCBs, extended up to 800AF

Type number comparison between new α -TWIN series and the existing series breakers according to the interrupting capacity

Molded case circuit breakers

■ IEC and CE marking conformed

• Line protection

Series	Ampere frame	Pole	New α -TWIN series		Type	Existing series Type
			Interrupting capacity(kA) Icu/Ics 230V AC	440V AC		
S series	30	2	5/3	2.5/2	SA32C□-CE	SA32B□
		3			SA33C□-CE	SA33B□
	50	2	10/5	7.5/4	SA52C□-CE	SA52B□
		3			SA53C□-CE	SA53B□
		2	25/13	10/5	SA52RC□-CE	SA52R□
		3			SA53RC□-CE	SA53R□
	60	2	10/5	7.5/4	SA62C□-CE	SA62B□
		3			SA63C□-CE	SA63B□
		2	25/13	10/5	SA62RC□-CE	SA62R□
		3			SA63RC□-CE	SA63R□
	100	2	50/25	25/7	SA102C□-CE	SA102BA□
		3			SA103C□-CE	SA103BA□
		2	100/50	50/13	SA102RC□-CE	SA102RA□
		3			SA103RC□-CE	SA103RA□
225	2	50/25	25/7	SA202C□-CE	SA202BA□	
	3			SA203C□-CE	SA203BA□	
	2	100/50	50/13	SA202RC□-CE	SA202RA□	
	3			SA203RC□-CE	SA203RA□	
400	2	50/25	35/18	SA402C□-CE	SA402B□	
	3			SA403C□-CE	SA403B□	
	2	85/43	50/25	SA402RC□-CE	SA402R□	
	3			SA403RC□-CE	SA403R□	
600	3	85/43	50/25	SA603RC□-CE	SA603R□	
800	3	85/43	50/25	SA803RC□-CE	SA803R□	
E series	30	2	2.5/2	1.5/1	EA32AC□-CE	EA32□
		3			EA33AC□-CE	EA33□
	50	2	2.5/2	1.5/1	EA52AC□-CE	EA52A□
		3			EA53AC□-CE	EA53A□
		2	5/3	2.5/2	EA52C□-CE	EA52B□
		3			EA53C□-CE	EA53B□
	60	2	5/3	2.5/2	EA62C□-CE	EA62B□
		3			EA63C□-CE	EA63B□
	100	3	5/3	1.5/1(400V AC)	EA103AC□-CE	EA103F□
		2	25/13	10/5	EA102C□-CE	EA102B□
		3			EA103C□-CE	EA103B□
	225	2	35/18	15/4	EA202C□-CE	EA202B□
		3			EA203C□-CE	EA203B□
	400	2	35/18	25/13	EA402C□-CE	EA402B□
3		EA403C□-CE			EA403B□	
600	3	50/25	35/18	EA603C□-CE	EA603B□	
800	3	50/25	35/18	EA803C□-CE	EA803B□	

■ IEC and CE marking conformed

• Motor protection

Series	Ampere frame	Pole	New α -TWIN series		Type	Existing series Type
			Interrupting capacity(kA) Icu/Ics			
			230V AC	440V AC		
S series	30	2	5/3	2.5/2	SA32CM□-CE	SA32BM□
		3			SA33CM□-CE	SA33BM□
	50	3	10/5	7.5/4	SA53CM□-CE	SA53BM□
		3	25/13	10/5	SA53RCM□-CE	SA53RM□
	60	3	10/5	7.5/4	SA63CM□-CE	SA63BM□
	100	3	50/25	25/7	SA103CM□-CE	SA103BAM□
		3	100/50	50/13	SA103RCM□-CE	SA103RAM□
	225	3	50/25	25/7	SA203CM□-CE	SA203BAM□
3		100/50	50/13	SA203RCM□-CE	SA203RAM□	
E series	30	3	2.5/2	1.5/1	EA33ACM□-CE	EA33M□
	50	3	5/3	2.5/2	EA53CM□-CE	EA53BM□
	60	3	5/3	2.5/2	EA63CM□-CE	EA63BM□
	100	3	25/13	10/5	EA103CM□-CE	EA103BM□
	225	3	35/18	15/4	EA203CM□-CE	EA203BM□

■ UL 489 Listed

• Line protection

Series	Ampere frame	Pole	New α -TWIN series			Type	Existing series Type
			Interrupting capacity (kA)				
			240V AC	480Y/277V AC	480V AC		
S series	50	2	14	–	–	SA52RCUL□	–
		3				SA53RCUL□	–
	100	2	35	–	–	SA102CUL□	SA102BAUL□
		3				SA103CUL□	SA103BAUL□
		2	85	25	–	SA102RCUL□	SA102RAUL□
		3				SA103RCUL□	SA103RAUL□
	225	2	35	–	–	SA202CUL□	SA202BAUL□
		3				SA203CUL□	SA203BAUL□
		2	85	25	–	SA202RCUL□	SA202RAUL□
		3				SA203RCUL□	SA203RAUL□
	400	2	42	25	25	SA402CUL□	SA402BUL□
		3				SA403CUL□	SA403BUL□
		2	85	50	50	SA402RCUL□	SA402RUL□
		3				SA403RCUL□	SA403RUL□
600	3	85	50	50	SA603RCUL□	SA603RUL□	
800	3	85	50	50	SA803RCUL□	SA803RUL□	
E series	100	2	14	–	–	EA102CUL□	–
		3				EA103CUL□	–

Earth leakage circuit breakers

IEC and CE marking conformed

• Line protection

Series	Ampere frame	Pole	New α -TWIN series		Type	Existing series Type
			Interrupting capacity(kA) lcu/lcs 230V AC	440V AC		
SG series	30	3	5/3	2.5/2	SG33C □-CE	SG33B□
	50	3	10/5	7.5/4	SG53C □-CE	SG53B□
			25/13	10/5	SG53RC □-CE	SG53R□
	60	3	10/5	7.5/4	SG63C □-CE	SG63B□
			25/13	10/5	SG63RC □-CE	SG63R□
	100	3	50/25	25/7	SG103C □-CE	SG103BA□
100/50			50/13	SG103RC □-CE	SG103RA□	
225	3	50/25	25/7	SG203C □-CE	SG203BA□	
		100/50	50/13	SG203RC □-CE	SG203RA□	
400	3	50/25	35/18	SG403C □-CE	SG403B□	
EG series	30	2	2.5/2	–	EG32AC □-CE	EG32F□
		3			EG33AC □-CE	EG33F□
		3	2.5/2	1.5/1	EG33C □-CE	EG33B□
	50	2	2.5/2	–	EG52AC □-CE	EG52F□
		3			EG53AC □-CE	EG53F□
		3	5/3	2.5/2	EG53C □-CE	EG53B□
	60	3	5/3	2.5/2	EG63C □-CE	EG63B□
	100	3	5/3	–	EG103AC □-CE	EG103F□
		2	10/5	–	EG102C □-CE	EG102B□
		3	25/13	10/5	EG103C □-CE	EG103B□
	225	3	35/18	15/4	EG203C □-CE	EG203B□
	400	3	35/18	25/13	EG403C □-CE	EG403B□

• Motor protection

Series	Ampere frame	Pole	New α -TWIN series		Type	Existing series Type
			Interrupting capacity(kA) lcu/lcs 230V AC	440V AC		
SG series	30	3	5/3	2.5/2	SG33CM □-CE	SG33BM□
	50	3	10/5	7.5/4	SG53CM □-CE	SG53BM□
	60	3	10/5	7.5/4	SG63CM □-CE	SG63BM□
	100	3	50/25	25/7	SG103CM □-CE	SG103BAM□
			100/50	50/13	SG103RCM □-CE	SG103RAM□
225	3	50/25	25/7	SG203CM □-CE	SG203BAM□	
		100/50	50/13	SG203RCM □-CE	SG203RAM□	
EG series	30	3	2.5/2	1.5/1	EG33CM □-CE	EG33BM□
	50	3	5/3	2.5/2	EG53CM □-CE	EG53BM□
	60	3	5/3	2.5/2	EG63CM □-CE	EG63BM□
	100	3	25/13	10/5	EG103CM □-CE	EG103BM□
	225	3	35/18	15/4	EG203CM □-CE	EG203BM□

■ **JIS C8371**

• **Line protection**

Series	Ampere frame	Pole	New α -TWIN series		Type	Existing series Type
			Interrupting capacity(kA) sym. 200V AC	415V AC		
SG series	400	3	85	50	SG403RC	SG403R□
	600	3	85	50	SG603RC	SG603R□
	800	3	85	50	SG803RC	SG803R□
EG series	600	3	50	35	EG603C	EG603B□
	800	3	50	35	EG803C	EG803B□

■ **UL 489 Listed**

• **Line protection**

Series	Ampere frame	Pole	New α -TWIN series		Type	Existing series Type
			Interrupting capacity(kA) 240V AC	480Y/277V AC		
SG series	50	3	14	–	SG53RCUL □	–
	100	3	35	–	SG103CUL □	SG103BAUL □
	225	3	35	–	SG203CUL □	SG203BAUL □
	400	3	42	–	SG403CUL □	–
EG series	100	2	14	–	EG102CUL □	–
		3			EG103CUL □	–

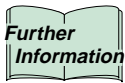

See D & C Catalog 19th Edition, No.06 (MCCBs) and 07 (ELCBs).

AS-Interface analog slaves FM6A

Flat and compact slaves with AS-i specification Ver. 2.1

■ Features

The FM6A is an analog slave that complies with the AS-Interface specification: Ver. 2.1 (Slave profile: S7.3).

- The FM6A is a flat and compact slave which is provided with 2 channels, similar to FM6D1.
- FUJI AS-i analog slaves are the world's smallest slaves.
- Mounting plates are available in two types: IEC rail/screw dual mounting and exclusive screw mounting.
- The actual slave can be easily fixed to the mounting plate using one screw.
- Actuators and sensors can be easily connected by single-action M12 connectors (IEC 60947-5-2).
- AS-i specification: V2.1

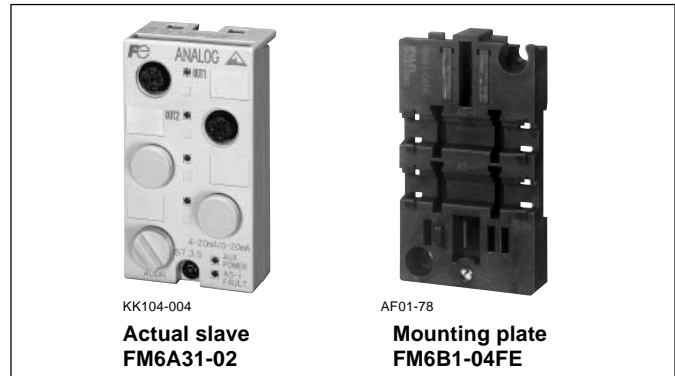

■ Ratings and specifications

Type		FM6A11-20 FM6A21-20	FM6A51-20	FM6A31-02	FM6A41-02
AS-i power	Operating voltage (in accordance with AS-i specification)	30V DC (26.5 to 31.6V DC)			
	Current consumption	Max. 50mA			
External power	Operating voltage	24V DC (21.6 to 30V DC)			
	Current consumption	Max. 25mA + sensor supply current	Max. 25mA	Max. 40mA + output load current	Max. 35mA + output load current
LED indication G: Green R: Red	AS-i FAULT (G/R)	G on: Normal operation, R on: Communications error R on and orange (G+R) on alternating: Slave has address=0 R and G alternating on: Peripheral fault, R flashing: Hardware major fault, Off: Power off			
	EXT POWER (G)	On/off: 24V auxiliary power on/off			
Applicable input/output connector		M12			
Degree of protection (IEC 60529)		IP67			
Reference temperature		25°C			
Operating temperature		-20 to 60°C (no icing or no condensation)			
Storage temperature		-25 to 85°C (no icing or no condensation)			
Electrical protection for AS-i connection	Reverse polarity protection	Built-in			
	Electrostatic discharge resistance	Contact discharge method: ±4kV Aerial discharge method: ±8kV, IEC 61000-4-2 (Class B)			
	Electromagnetic field noise immunity	80 to 1000MHz Electric field strength: 10V/m, IEC 61000-4-3 (Class A)			
	Burst noise	2kV (Class B) / 1kV (Class A), IEC 61000-4-4			
Vibration resistance	Rail mounting (IEC 68-2-6)	10 to 55Hz, 0.5mm one-way amplitude			
	Screw mounting (IEC 68-2-6)	10 to 55Hz, 1mm one-way amplitude			
Shock resistance	Rail mounting (IEC 68-2-27)	150m/s ² (11ms)			
	Screw mounting (IEC 68-2-27)	300m/s ² (18ms)			
Mass		Approx. 120g (including mounting plate)			
Addressing method		Can be done with an addressing unit (FL1HA-E) via an addressing cable (FX9Y002) connected to the addressing jack on the front of the slave. Connecting the addressing cable to a slave will disconnect the slave from the AS-i connection.			

■ Ratings and specifications (continued)

• **Input slave**

Type (actual slave)	FM6A11-20	FM6A21-20	FM6A51-20
Slave type	Analog slave		
AS-Interface profile	S7.3.D		
Number of channel	2		
Input range (changed by a parameter)	4 to 20mA 0 to 20mA	0 to 10V 1 to 5V	Pt100: -200 to +850°C JPt100: -200 to +500°C
Digital value	0 to 27648 (0000h to 6C00h)		Pt100: -2000 to +8500 (F830h to 2134h) JPt100: -2000 to +5000 (F830h to 1388h)
Input impedance	250Ω	100kΩ	—
Current tolerance	Max. 40mA	—	—
Voltage tolerance	—	±25V	—
Supply to external sensor	Max. 500mA (total of 2 channels)		—
Resolution	16bit (0.49μA)	16bit (0.245mV)	16bit (0.1°C)
Overall accuracy (for full scale)	±0.2% (25°C)		
Temperature dependency	±0.1% / 10°C		
Conversion speed	20ms / 2 channels		280ms / 2channels
Wiring	4-wire (differential) / 2-wire	4-wire (differential)	4-wire
Mounting plate (sold separately)	FM6B1-04FE (Rail/screw dual mounting type) FM6B2-04FE (Screw mounting type)		

• **Output slave**

Type (actual slave)	FM6A31-02	FM6A41-02
Slave type	Analog slave	
AS-Interface profile	S7.3.5	
Number of channel	2	
Output range (changed by a parameter)	4 to 20mA 0 to 20mA	0 to 10V 1 to 5V
Digital value	0 to 27648 (0000h to 6C00h)	
Load impedance	Max. 500Ω (Max. 0.1mH)	Min. 1kΩ (Max. 0.1μF)
Output current	Max. 24mA	—
Output voltage	—	Max. 12V
Resolution	12bit (6μA)	12bit (3mV)
Overall accuracy (for full scale)	±0.5% (-20 to 60°C)	
Conversion speed	3ms / 2 channels	
Wiring	2-wire	2-wire
Mounting plate (sold separately)	FM6B1-04FE (Rail/screw dual mounting type) FM6B2-04FE (Screw mounting type)	

■ Dimensions, mm

Actual slave

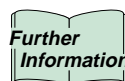
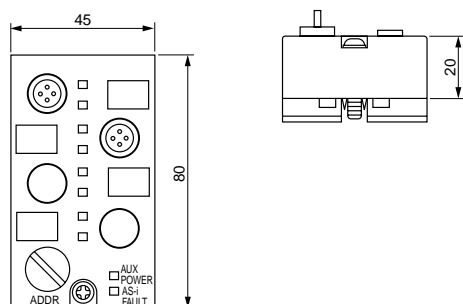

See page 05/40 of D & C catalog 19th Edition.

AS-Interface waterproof connector type A/B slaves, FM6DB1

The number of connectable slaves has increased from 31 to 62.

Features

The number of connectable slaves has increased from 31 to 62, as the FM6DB1 slaves conform to AS-i specifications Ver2.1.

- The size and structure of FM6DB1 are same as our conventional model FM6D1.
- Four points are provided with the input slaves and three points are provided with the output slaves.
- AS-i specification: V2.1



Ratings and specifications

Type (actual slave)	NPN model PNP model	FM6DB1-40XXN FM6DB1-40XXP	FM6DB1-03TNX FM6DB1-03TPX
Slave type		A/B slave	
Number of inputs/outputs		4 inputs	3 outputs
AS-Interface profile (I/O, ID, ID2)		0, A, 2	8, A, 2
Assignment of data bits			
Data bit D0		Input 1	Output 1
Data bit D1		Input 2	Output 2
Data bit D2		Input 3	Output 3
Data bit D3		Input 4	—
Operating voltage (in accordance with AS-i specification)		30V DC (26.5 to 31.6V DC)	
Current consumption	Slave only Including sensors	45mA DC or less 245mA DC or less	45mA DC or less —
LED indication G: Green R: Red Y: Yellow	AS-i (G/R)	G on: Normal operation, R on: Communications error R on and Orange (G+R) on alternating: Slave has address = 0 R flashing: Input power overload, Off: AS-i power off	
	EXT POWER (G)	—	On/off: 24V DC external power on/off
	IN1 to IN4 (Y) OUT1 to OUT3 (Y)	On/off: Input on/off —	— On/off: Output on/off
Input	Switching level High/Low	$\geq 10V / \leq 6V$	
	NPN On (source)/off current	5mA / $\leq 1.5mA$	
	PNP On (sink)/off current	5mA / $\leq 1.5mA$	
Sensor power supply via yellow AS-i cable	Short-circuit and overload protection	Built-in	
	Sensor voltage range	20 to 27V ($I \leq 160mA$) 18 to 27V ($I \leq 200mA$)	
	Current carrying capacity for all inputs *	200mA ($T_a \leq 25^\circ C$) 160mA ($T_a \leq 45^\circ C$)	

Notes: * If a sensor with power consumption of more than 200mA is connected to the sensor power supply of the slave, the overload and short-circuit protective function will operate and the sensor power supply will be stopped even when 0.5ms has passed after the inrush current is generated. If a connected sensor has a high inrush current, make sure that current consumption with a lapse of 0.5ms after the inrush current is 200mA or less.

■ Ratings and specifications (continued)

Type (actual slave)	NPN model PNP model	FM6DB1-40XXN FM6DB1-40XXP	FM6DB1-03TNX FM6DB1-03TPX
Output (per point)	NPN model PNP model External power supply 24V DC Current carrying capacity per point Residual voltage Short-circuit protection Inductive surge protection Output status on communication error	— — — — — — — —	NPN transistor PNP transistor Via black AS-i flat cable Approx. 1A 0.8V or less Built-in Built-in Off
Applicable input/output connector	M12 connector		
Degree of protection (IEC 60529)	IP67 (with M12 connectors, slave mounting plate and AS-i cable, sold separately)		
Rated temperature Operating temperature Storage temperature	25°C -25 to +60°C (no icing or no condensation) -25 to +85°C (no icing or no condensation)		
Electrical protection for AS-i connection	Reverse polarity protection	Built-in	
	Electrostatic discharge resistance	Contact discharge method: ±4kV Aerial discharge method: ±8kV, IEC 61000-4-2 (Class B)	
	Electromagnetic field noise immunity	80 to 1000MHz Electric field strength: 10V/m, IEC 61000-4-3 (Class A)	
	Burst noise	2kV (Class B)/1kV (Class A), IEC 61000-4-4	
Vibration resistance	Rail mounting (IEC 68-2-6)	10 to 55Hz, 0.5mm one-way amplitude	
	Screw mounting (IEC 68-2-6)	10 to 55Hz, 1mm one-way amplitude	
Shock resistance	Rail mounting (IEC 68-2-27)	150m/s ² (18ms)	
	Screw mounting (IEC 68-2-27)	300m/s ² (11ms)	
Mounting plate (sold separately)	Rail/screw dual mounting type Screw mounting type	FM6B1-04FK FM6B2-04FK	FM6B1-04FE FM6B2-04FE
Mass	Approx. 80g (excluding mounting plate, approx. 35g, sold separately)		
Addressing method (Addresses: between 1A (1B) and 31A (31B))	Can be done with an addressing unit (FL1HA-E) via an addressing cable (FX9Y002) connected to the addressing jack on the front of the slave. Connecting the addressing cable to a slave will disconnect the slave from the AS-i connection.		

■ Current carrying capacity for all inputs



See page 05/33 of D & C catalog 19th Edition.

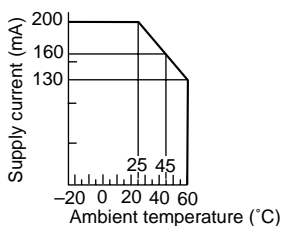

■ Dimensions, mm

Actual slave

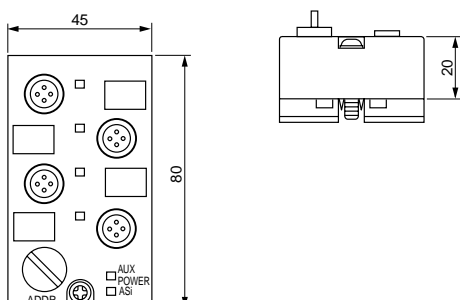

AS-Interface dustproof connector type A/B slaves, FM4DB, FM4DB1

World's first AS-i A/B slave with dustproof structure IP40

■ Features

Dustproof structure IP40 with outstanding resistance to the environment.

The number of connectable slaves has increased from 31 to 62, as the FM4DB slaves conform to AS-i specifications Ver2.1.

- The size and structure of FM4DB and FM4DB1 are same as our conventional model FM4D and FM4D1.
- Four points are provided with the input slaves and three points are provided with the output slaves.
- AS-i specification: V2.1

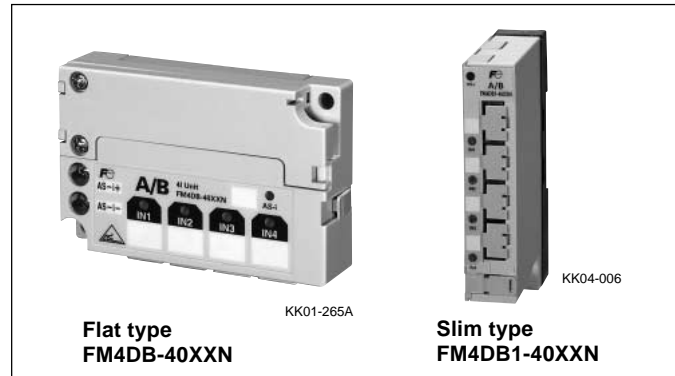

■ Ratings and specifications

Type	NPN model	FM4DB-40XXN Flat type	FM4DB1-40XXN Slim type	FM4DB-03TNX Flat type	FM4DB1-03TNX Slim type
Slave type		A/B slave			
Number of inputs/outputs		4 inputs		3 outputs	
AS-Interface profile (I/O, ID, ID2)		0, A, 0		8, A, 0	
Assignment of data bits	Data bit D0 Data bit D1 Data bit D2 Data bit D3	Input 1 Input 2 Input 3 Input 4		Output 1 Output 2 Output 3 —	
Operating voltage (in accordance with AS-i specification)		30V DC (26.5 to 31.6V DC)			
Current consumption	Slave only Including sensors	45mA max. 245mA max.	45mA max. 205mA max.	45mA max. —	
LED indication	AS-i (G/R) External power supply (G) IN1 to IN4 (Y) OUT1 to OUT3 (Y)	G on: Power on, R on and Orange (G+R) on alternating: Slave has address = 0 R on: Communications error, R flashing: Input power overload, Off: AS-i power off			
		—		— On	
		On/off: Input on/off		—	
Input	Switching level High/Low On/off current	$\geq 10V / \leq 6V$ $\geq 5mA / \leq 1.5mA$		—	
Sensor power supply via AS-i cable	Short-circuit and overload protection Sensor voltage range Current carrying capacity for all inputs	Built-in 20 to 26.5V ($I \leq 160mA$) 18 to 26.5V ($I \leq 200mA$) 200mA ($T_a \leq 25^\circ C$) 160mA ($T_a \leq 45^\circ C$)	Built-in 20 to 27V ($I \leq 160mA$) — 160mA ($T_a \leq 25^\circ C$) 130mA ($T_a \leq 45^\circ C$)	— — —	
Output *	External power supply 24V DC Operating voltage range NPN model PNP model Current carrying capacity, typical Voltage drop Inductive surge protection Output status on communications error	— — — — — — —		Via black AS-i flat cable 20 to 30V DC NPN transistor — Max. 200mA 1.5V max. Built-in Off	
Degree of protection (IEC 60529)		IP40			
Mass		Approx. 60g			

Note: * Short-circuit protection is not built-in.

■ Dimensions, mm

• FM4DB

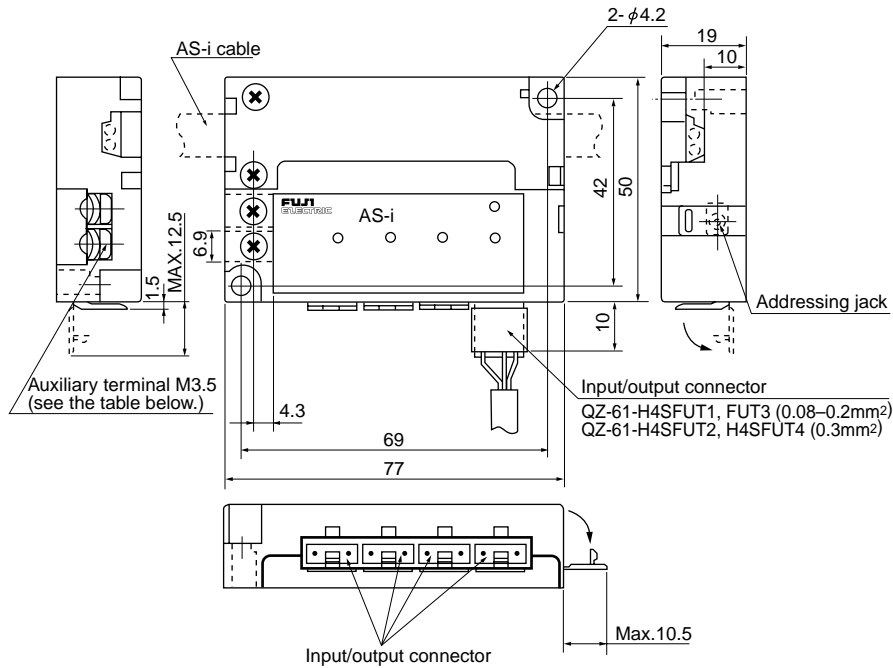

Slave type	Auxiliary terminal-block
FM4DB-40XXN	AS-i cable branch use
FM4DB-03TNX	External power supply +24V DC use

■ Current carrying capacity for all inputs

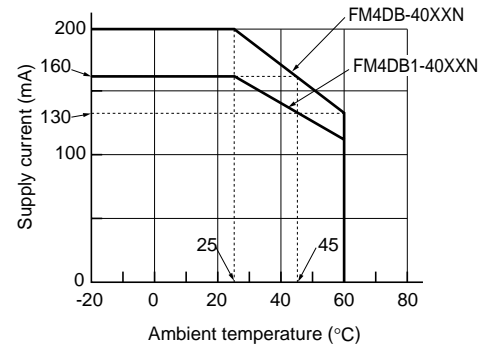

• FM4DB1

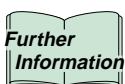
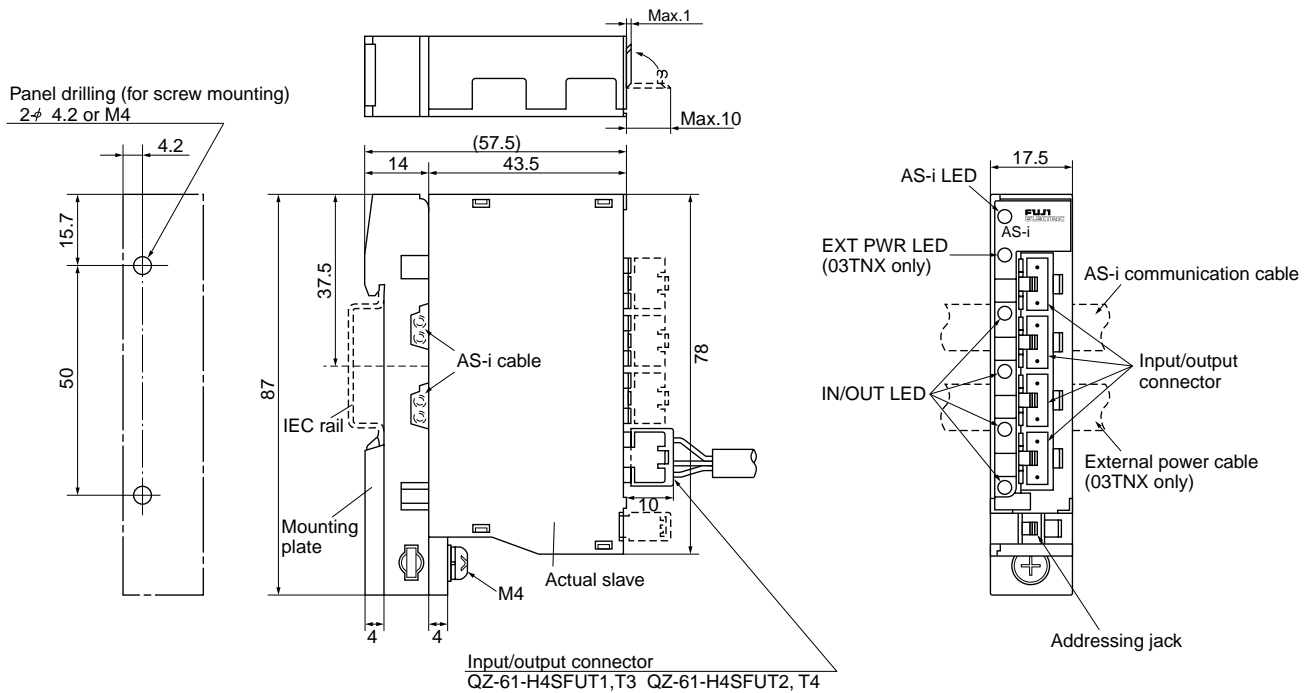

See pages 05/48 and 05/55 of D & C Catalog 19th Edition.

AS-Interface 7-segment display FM4DP2

A multi-purpose slave with a 2-digit, 7-segment display and illuminated pushbutton switch

■ Features

- An excellent user interface achieved with a dedicated FB (function block) combining FUJI's PLC, MICREX-SX.
- Ideal for small- and medium-scale digital picking systems.
- A 2-core type made possible with AS-interface communications, featuring two 7-segment displays and a brightly illuminated pushbutton switch.
- Layout changes can be made using the AS-i's flexible wiring method without requiring manufacturer-authorized engineers, thus contributing to a considerable reduction in total costs during the customer's product life cycle.
- Like other slaves, advanced piercing technology is used for AS-i cable connection, allowing the cable to be crimped and connected with ease.
- Conforms to AS-i specifications V2.04

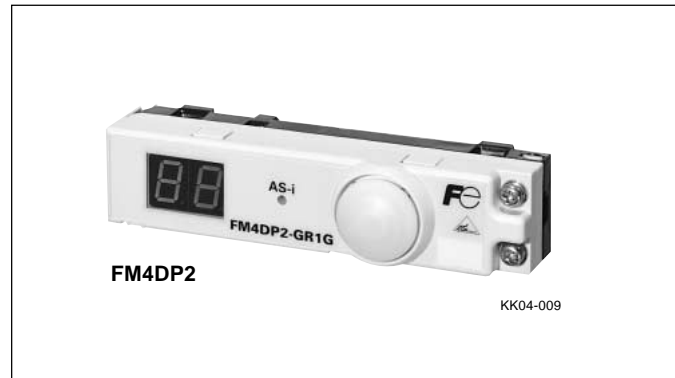

■ Ratings and specifications

Type		FM4DP2-GR1G	FM4DP2-GR1R	FM4DP2-RR1R	FM4DP2-RR1G
Slave type		Standard slave			
7-segment display color	10's digit	Green	Green	Red	Red
	1's digit	Red	Red	Red	Red
Pushbutton illuminated color		Green	Red	Red	Green
AS-i profile (I/O and ID)		7, F			
Control voltage (depending on AS-i specifications)		26.5 to 31.6V Supplied from AS-i line (with no external auxiliary power supply required)			
Current consumption		75mA max. (with "88" displayed on 7-segment indicator and illuminated pushbutton switch on) 45mA max. (with 7-segment indicator and illuminated pushbutton switch turned off)			
Display	AS-i	Green LED ON: AS-i power supply turned on (Normal operation) Red LED and orange (red mixed with green) LED lit alternately: Address 0 Red LED lit: Communications error			
	Illuminated pushbutton switch	Illuminated color: Green (24mm dia.)		Illuminated color: Red (24mm dia.)	
		7-segment	1's digit	Character height: 13 to 14mm (red)	Character height: 13 to 14mm (red)
		10's digit	Character height: 13 to 14mm (green)	Character height: 13 to 14mm (green)	Character height: 13 to 14mm (red)
Input signal		1NO contact			
Output signal		<ul style="list-style-type: none"> • Illuminated pushbutton switch on • 7-segment-indicator (4-bit output from AS-i slave IC is processed in microcomputer and displayed) 			
Logic allocations		Input *1		Output	
		Type	Data bit	Type	Data bit
		Pushbutton switch and side connector *2	D0	Illumination 7-segment	D0 to D3 D0 to D3
Degree of protection		IP40			

*1 An input signal with a minimum duration of 150ms is accepted normally. If the duration is less than 150ms, the input will not always be accepted.

*2 The pushbutton switch and the two-pin connector on the side of the unit are connected in parallel.

■ Dimensions, mm

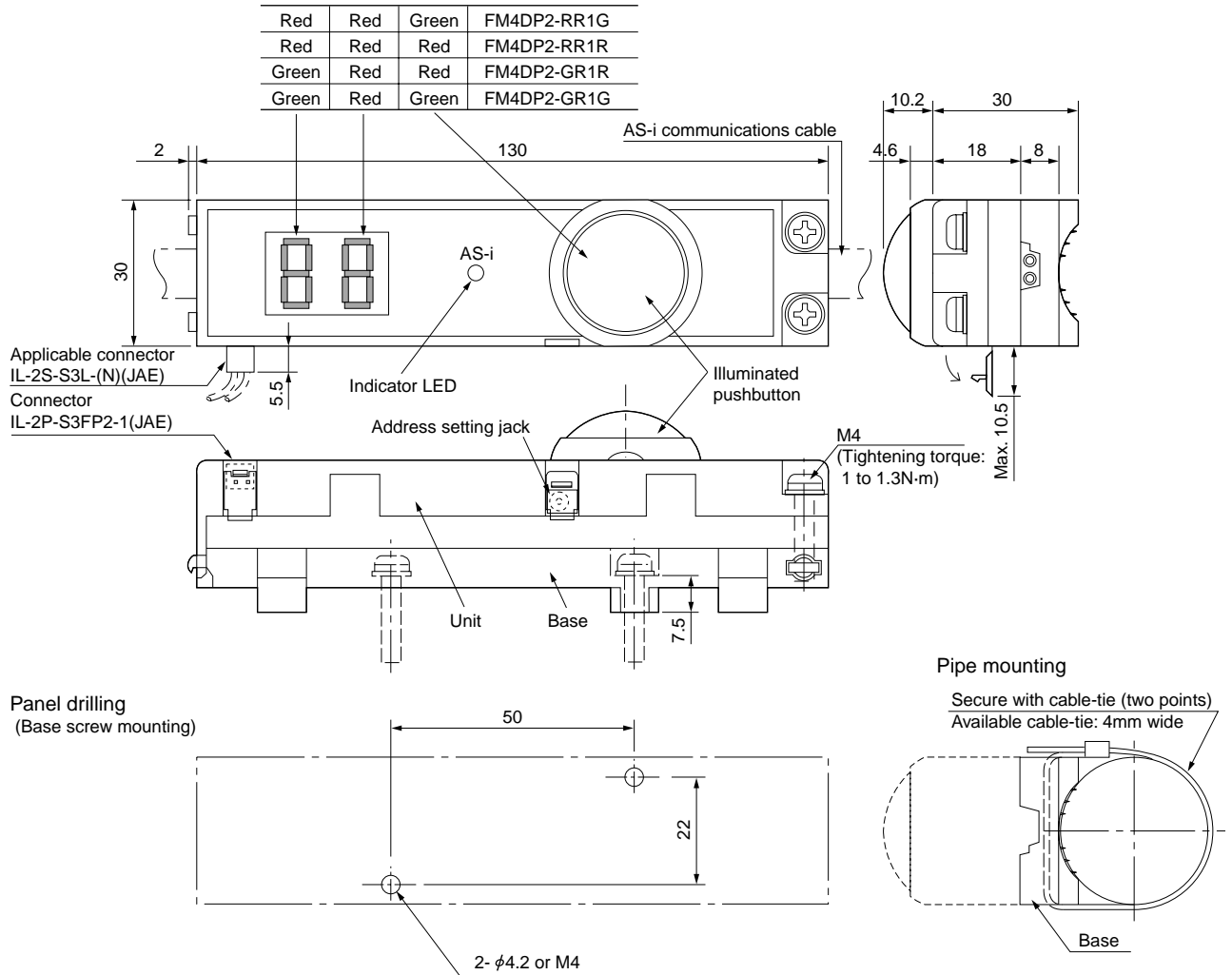

■ System configuration example

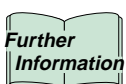
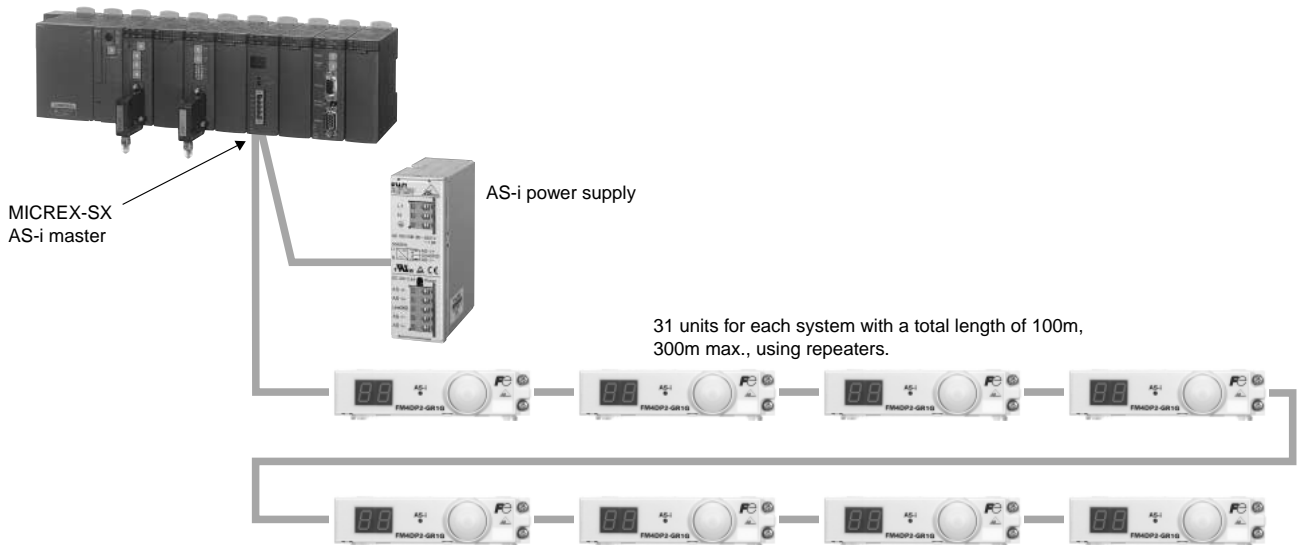

See page 05/64 of D & C Catalog 19th Edition.

As-Interface addressing unit FL1HA-E

Incorporates versatile new functions compatible with version 2.1

■ Features

- In addition to conventional address setting functions, this unit makes it possible to read the addresses of slaves on the AS-i line and the I/O data of the slaves.
- Address settings can be made for standard slaves and A/B slaves.
- Address settings can be made for slaves provided with an addressing jack (e.g., FM6D□1, FM4D□, FM2D1, and FM1D slaves) over an address setting conversion cable.

■ Ratings and specifications

Type	FL1HA-E
Operating temperature range	0 to 40°C
Storage temperature range	-20 to 40°C
Display	LCD
Control key	Flat key (Numeric 5-key pad)
Degree of protection	IP20
Power supply	Built-in secondary battery Charging time: Approx. 14h (with provided battery charger)
Secondary battery life	Addresses can be read or written approximately 250 times with a full charge. If the battery is charged and discharged for a maximum of 500 cycles, the number of possible address reading and writing times will be gradually reduced by the battery memory effect.
Battery charger	Provided
Addressing cable	FX9Y002 (sold separately)
AS-i specifications	Version 2.1 compatible

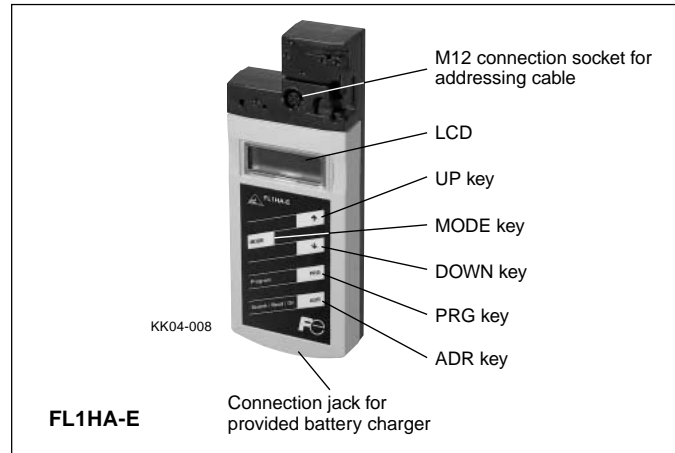

■ Dimensions, mm

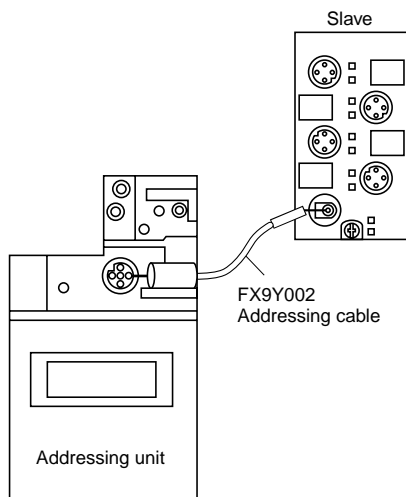
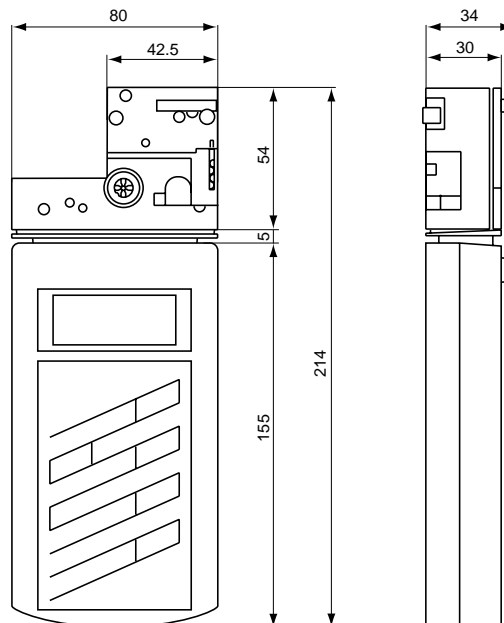

Error display

Code	Description	Configuration 1	Configuration 2
F1	Overloading or short-circuiting of the communications power supply provided from the unit.	○	—
F2	The slave is disconnected, the slave is not connected properly, or a failure occurred in reading the slave.	○	—
F3	An error occurred in writing the address or ID code 1.	○	—
F4	An error occurred in an address setting. (An attempt was made to write a duplicated address.) An error occurred in an address setting. (The same address is already used.)	○	—
F5	An error occurred in a settings change. (A slave with address 0 is connected.)	—	○
F6	An error occurred in a standard slave setting. (An attempt was made to write an A/B slave address, e.g., 01A or 01B, to a standard slave.)	○	○
F7	An error occurred in an A/B slave setting. (An attempt was made to write a standard slave address, e.g., 01 or 02, to an A/B slave.)	○	○
F8	The response signal from the slave was not received correctly.	○	○
	The secondary battery needs charging.	○	○

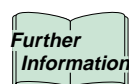
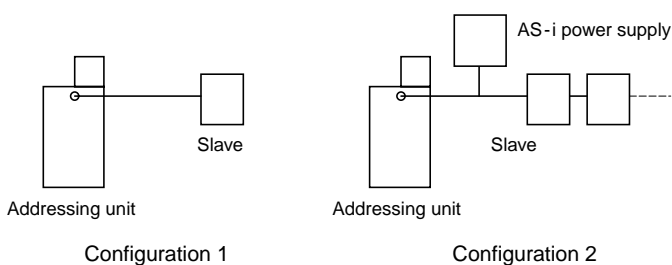

See page 05/70 of D & C Catalog 19th Edition.

Other functions

Press the ADR key to turn on the power first. Then press the MODE key to select the following functions. Use the PARA and DATA functions only in functional tests for slaves.

Name	Function
ID	Reads the ID code.
ID1	Reads and writes ID code 1 (for version 2.1 compatible models only). Set the value with the UP or DOWN keys and press the PRG key to overwrite the ID code.
ID2	Reads ID code 2 (for version 2.1 compatible models only).
IO	Reads the IO code.
PERI	Peripheral fault flag indication (for version 2.1 compatible models only). If a slave is using this option flag, there will be no error while 0 is displayed. The display will change to 1 if an error occurs.
PARA	Displays and writes parameters. Check that the address of the slave is other than 0 before selecting this function. When this function is selected, the default value (F) will be displayed. Set the value (hexadecimal) with the UP or DOWN keys and press the PRG key. The parameter will then be sent to the slave once. By pressing the ADR key at this time, the last parameter written can be checked. After the slave is connected, the slave will operate according to the parameter as long as this function is operating. Once the slave is disconnected or another function is selected, the currently set parameter will be lost.
DATA	Reads input data and writes output data. Check that the address of the slave is other than 0 before selecting this function. The function transfers data while the ADR or PRG key is pressed. With this function selected, input data will be read once and displayed in hexadecimal. While the ADR key is pressed, the data of the slave will be read continuously. When the ADR key is released, communications with the slave will stop. Set the value (hexadecimal) with the UP or DOWN key and PRG key when writing output data. The data will then be transferred once. The data will be output to the slave continuously while the PRG key is pressed. When the ADR key is released, communications with the slave will stop.

Arresters for signal line and control circuit, CN226 series

Protects devices connected to power supplies from lightning damage

Features

- Highly effective surge suppression using protection method combining gas discharge tube, varistor, and avalanche diode.
- Large surge discharge current
- Fast response to surges reduces influence on device.
- A comprehensive lineup to suit all kinds of signal line applications (e.g., transducers, remote terminals, and sensors).
- Simple mounting to IEC rail.
- The arrester mounts to the terminal block using a plug-in connection for simple inspection and replacement. Signal lines are not opened even if the arrester is removed.

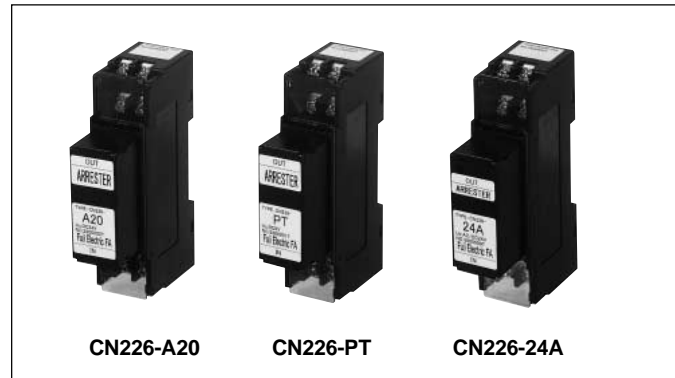

Specifications

For signal line circuit

Type	CN226-A20	CN226-A50	CN226-TC	CN226-PT	CN226-PM	CN226-SP	CN226-24	CN226-48	
Application	4-20mA	10-50mA	Thermocouple	Resistance thermometer	Potentiometer	Slow pulse	24V DC	48V DC	
Rated voltage	24V DC	48V DC	5V DC	8V DC	5V DC	12V DC	24V DC	48V DC	
Rated current	100mA						200mA		
Leakage current	5μA max.		10μA max.	2μA max.	10μA max.		5μA max.		
Reference voltage (1mA)	L-L 30V min.	61V min.	6.7V min.	11V min.	6.7V min.	14V min.	30V min.	60V min.	
Discharge voltage (1mA)	L-E 150V min.								
Clamping voltage (1,000A)	L-L	40V max.	100V max.	14V max.	22V max.	14V max.	25V max.	55V max.	130V max.
	L-E	300V max.							
Internal resistance	10Ω ±10% (Single)			2Ω ±10% (Single)	10Ω ±10% (Single)		1Ω ±10% (Single)		
No. of ports	2-port, combination type								
Response time	0.1μs max.								
Max. discharge current 8/20μs	L-L	5,000A							
	L-E	10,000A							

For control power supply circuit

Type	CN226-24A	CN226-48A	CN226-100A
Application	24V AC/DC	48V AC/DC	100V AC/DC
Rated voltage	24V AC/DC	48V AC/DC	100V AC/DC
Rated current	2A		
Leakage current	10μA max.		
Reference voltage (1mA)	L-L 40V min.	84V min.	180V min.
Discharge voltage (1mA)	L-E 300V min.	350V min.	
Clamping voltage (1,000A)	L-L	250V max.	400V max.
	L-E	400V max.	
Internal resistance	-	-	-
No. of ports	1-port, combination type		
Response time	0.1μs max.		
Max. discharge current 8/20μs	L-L	2,000A	5,000A
	L-E	2,000A	

Type number nomenclature

CN226 - □

Application circuit

- A20: 4 to 20mA
- A50: 10 to 50mA
- TC: Thermocouple
- PT: Resistance thermometer
- PM: Potentiometer
- SP: Slow pulse

- 24: Signal circuit 24V DC
- 48: Signal circuit 48V DC
- 24A: Control power supply circuit 24V AC/DC
- 48A: Control power supply circuit 48V AC/DC
- 100A: Control power supply circuit 110V AC/DC

Basic type

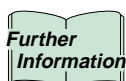

See page 09/56 of the D & C Catalog 19th Edition.

■ Dimensions, mm

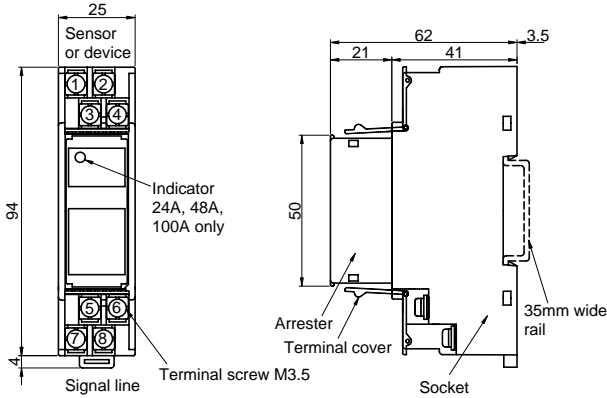

■ Internal circuit diagrams

4-20mA, 10-50mA

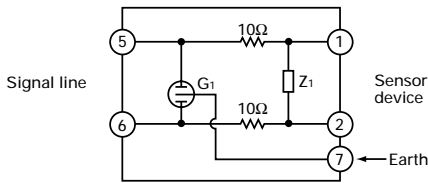

Thermocouple

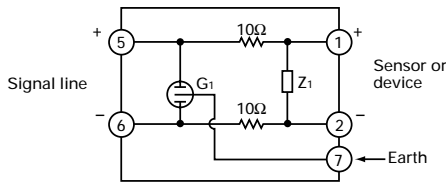

Resistance thermometer

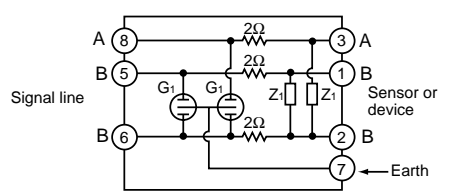

Potential meter, slow pulse

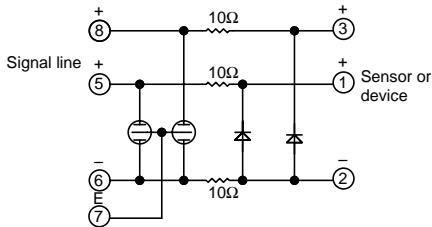

Signal line
24V, 48V DC

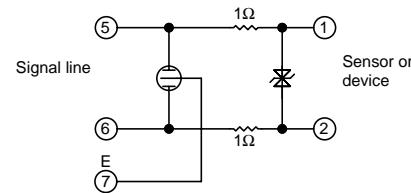

Control power supply
48V, 100V AC/DC

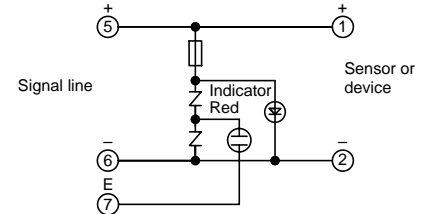

■ Example of application effects

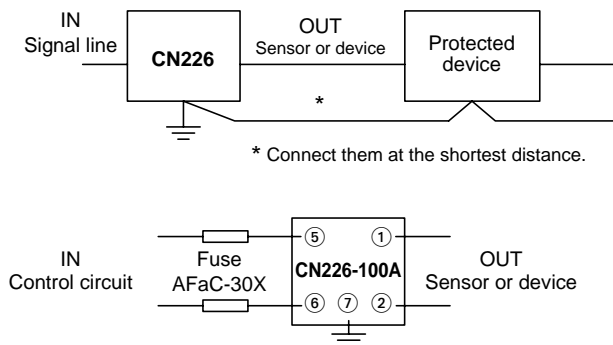

Note: When using an arrester CN226-100A, use a FUJI current-limiting fuse AFaC-30X for disconnection and short-circuit protection.

Note for thermocouple CN226-TC

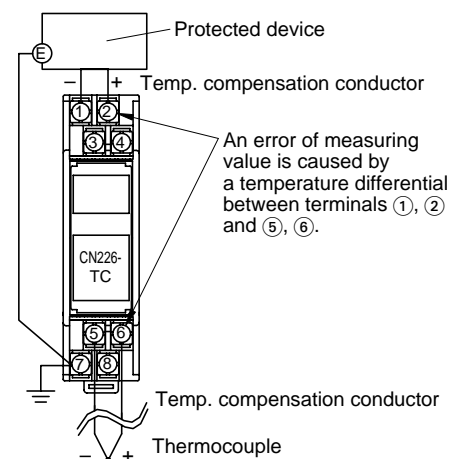

Arresters for network circuits CN227 series

Protects devices from all types of network surges

■ Features

- Compatible with a variety of communications networks (10Base-5, 100Base-TX, 10Base-T, RS-485, PLC T-Link)
- Highly effective surge protection, optimal design

CN227-EBT

- Supports high-speed communications (100Mbps or faster), with extremely fast response to surges.
- Compact, lightweight design, with RJ-45 modular connectors greatly simplifying connection

CN227-EB5

- Extremely low signal loss, and fast response
- Mounting tools and connection cables included for easy installation and replacement

CN227-RS42, RS44

- Slim 22.5mm width, with a European style terminal box
- Supports 2-wire (RS42), and 4-wire (RS44) systems.
- Extremely low signal loss and high surge resistance (10kA 8/20 μs) ensure a long service life.

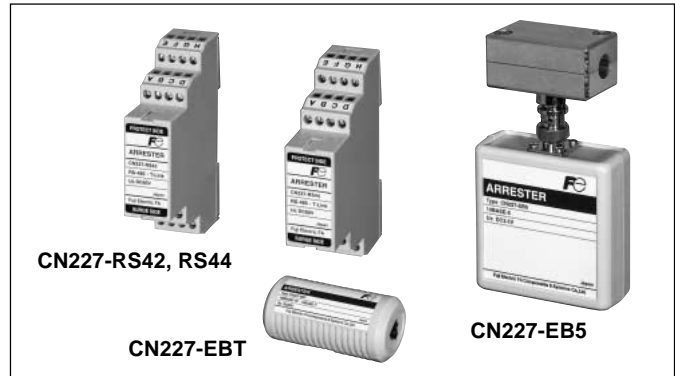

■ Specifications

Type	CN227-EBT	CN227-EB5	CN227-RS42	CN227-RS44
Application	Ethernet 10Base-T 100Base-TX	Ethernet 10Base-5	RS-485, PLC T-link	
			2-wire	4-wire
Rated voltage [Uc]	52V DC	3.5V DC	60V DC	
Transmission frequency band	DC to 100MHz (100Mbps)	DC to 20MHz (20Mbps)	DC to 2MHz	
Clamping voltage	L-L	40V max.	25V max.	
	L-E	150V max.	400V max.	
Max. discharge current 8/20μs	500A	10kA	10kA	
Ambient temperature and humidity	-10 to +60°C, 90% RH max. (No condensation)			
Interface	Modular (RJ-45)	Coaxial tap Tranceiver connection	Screw terminal connection	

■ Dimensions, mm

CN227-EBT

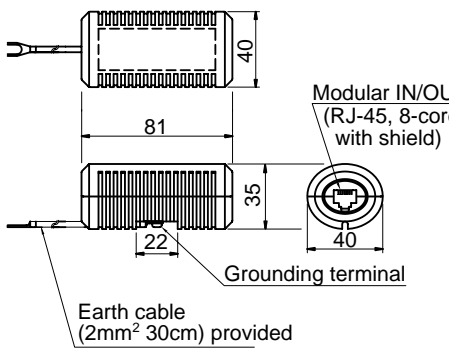

CN227-EB5

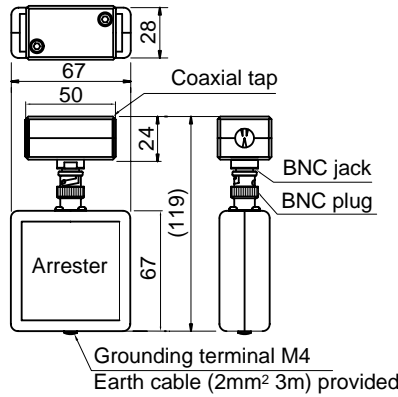

CN227-RS42, -RS44

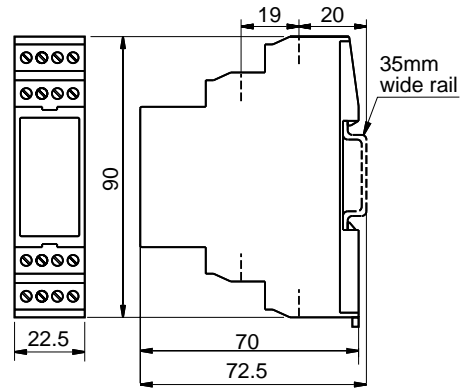

■ Internal circuit diagrams

CN227-EBT

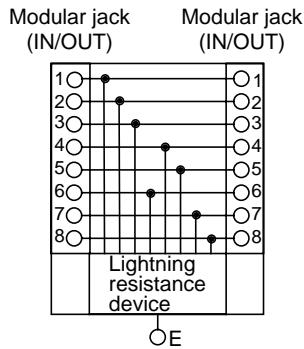

CN227-EB5

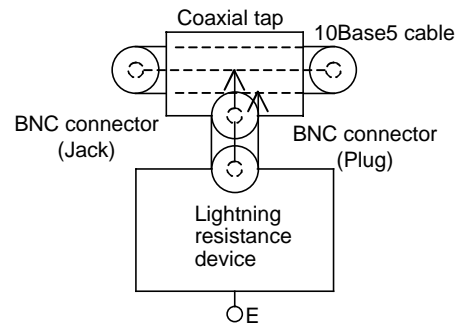

CN227-RS42

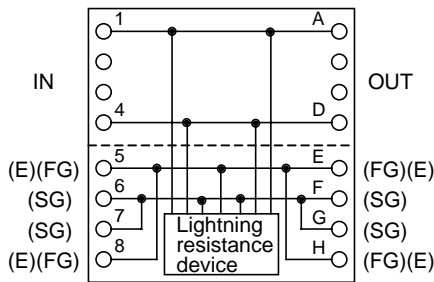

CN227-RS44

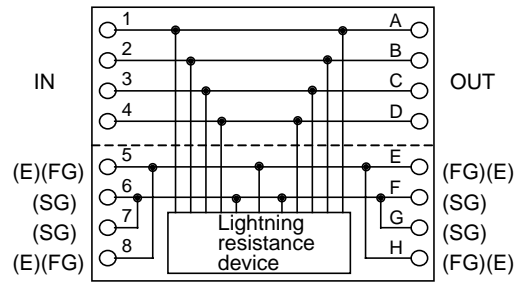

■ Example of application effects

CN227-EBT

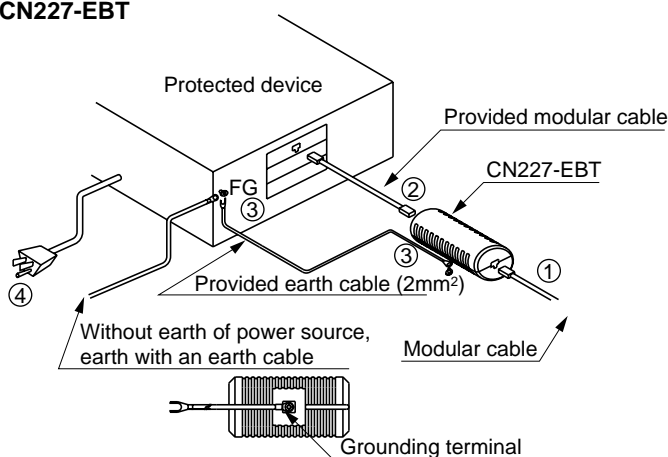

CN227-EB5

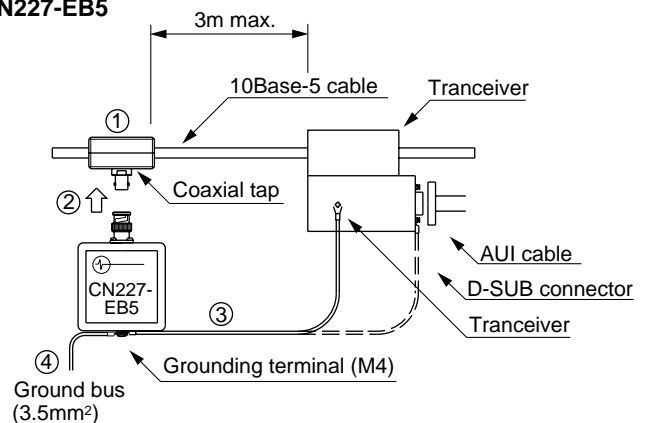

Command switches/ CCC approved AH, AR/DR and AM/DM series

Change in the position of CCC approved indication

16mm dia. AH164, AH165, AH165-2
 22mm dia. AR22/DR22, AM22/DM22
 30mm dia. AR30/DR30

Conventional → New
 Indication on the individual box → Indication on the switch body

AH164, 165, 165-2 (Except pilot lights)

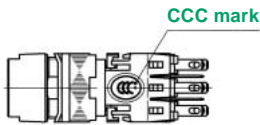

AR22, AR30, AM22
 (Except ZB type with terminal cover conformed to IP2X)

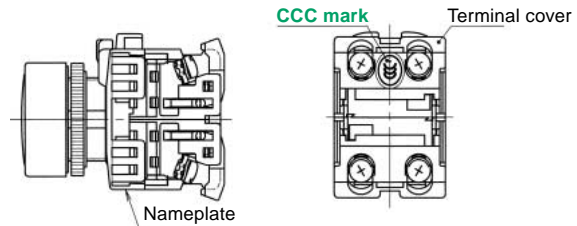

AR22
 ZB type with terminal cover conformed to IP2X

DR22, DR30, DM22
 Without transformer With transformer

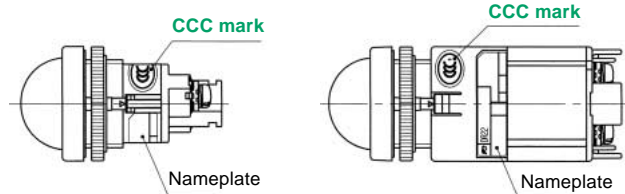
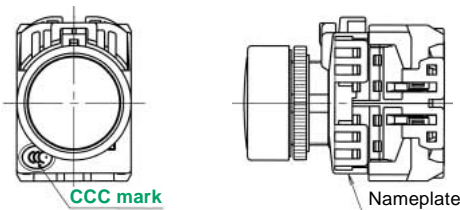

■ Time of modification: August 2004

Safety Considerations

- For safe operation, before using the product read the instruction manual or user manual that comes with the product carefully or consult the Fuji sales representative from which you purchased the product.
- Products introduced in this catalog have not been designed or manufactured for such applications in a system or equipment that will affect human bodies or lives.
- Customers, who want to use the products introduced in this catalog for special systems or devices such as for atomic-energy control, aerospace use, medical use, passenger vehicle, and traffic control, are requested to consult the Fuji sales division.
- Customers are requested to prepare safety measures when they apply the products introduced in this catalog to such systems or facilities that will affect human lives or cause severe damage to property if the products become faulty.
- For safe operation, wiring should be conducted only by qualified engineers who have sufficient technical knowledge about electrical work or wiring.

Fuji Electric FA Components & Systems Co., Ltd.

Gate City Ohsaki, East Tower
 11-2, Osaki 1-chome, Shinagawa-ku, Tokyo, 141-0032, Japan

Phone: +81-3-5435-7135~8
 Fax: +81-3-5435-7456~9
 URL <http://www.fujielectric.co.jp/fcs/eng>