

ABB MEASUREMENT & ANALYTICS | DATA SHEET

# TTH300

## Head-mount temperature transmitter



---

## Measurement made easy

Temperature transmitter for all communications protocols.

Redundancy thanks to two inputs

---

### Reliable temperature measurement for the highest demands

- High accuracy, reliability and durability
- Specific sensor linearization via Callendar-Van Dusen coefficients and with value pair table (32 points)
- Suited for ambient temperatures from  $-50\text{ °C}$  ( $-58\text{ °F}$ )

---

### Input circuit and communication

- Two universal sensor inputs for resistance thermometers (e.g.  $2 \times \text{Pt100}$  in three-wire circuit) and thermocouples
- 4 to 20 mA, HART®, PROFIBUS PA®, FOUNDATION Fieldbus®

---

### Safety

- Global approvals for explosion protection up to Zone 0
- Functional safety SIL 2 / SIL 3 in accordance with IEC 61508 (HART)
- Device versioning in accordance with NE 53
- Monitoring of the 4 to 20 mA loop current
- Wire break / corrosion monitoring in accordance with NE 89
- Sensor drift monitoring
- Device status signaling and freely configurable diagnostic categorization with diagnostic history according to NE 107

---

### Configuration and tracking

- Support of DTM, EDD and FDI standard (FIM)
- Event monitor for the logging of critical events
- Configuration monitor for configuration changes
- Turnable LCD indicator with operating buttons

## Specification

### CE Marking

The device fulfills all requirements for CE marking in accordance with all applicable guidelines.

### Electrical isolation

3.5 kV DC (approx. 2.5 kV AC), 60 s, input to output

### Input filter

50 / 60 Hz

### Switch-on delay

- HART: < 10 s ( $I_a \leq 3.6$  mA during switch-on cycle)
- PROFIBUS: 10 s, max. 30 s
- FOUNDATION Fieldbus: < 10 s

### Warm-up time

5 minutes

### Rise time $t_{90}$

400 to 1000 ms

### Measured value update

10/s with 1 sensor, 5/s with 2 sensors, depending on sensor type and sensor circuit

### Output filter

Digital filter 1 order: 0 to 100 s

### Weight

50 g

### Material

- Housing: polycarbonate
- Color: gray RAL9002
- Casting material: polyurethane (PUR), WEVO PU-417

### Installation conditions

- Mounting position: no restrictions
- Installation options:
  - Connection heads in accordance with DIN 43729 form B
  - Rail mounting (35 mm) in accordance with EN 60175 by means of latching base
  - Field mount housing

### Electrical connection

- Terminals with captive stainless steel screws, including soldering tags
- Lines up to a maximum of 1.5 mm<sup>2</sup> (AWG 16)
- Connection for handheld terminal

### Dimensions

See chapter **Dimensions** on page 17.

## Ambient conditions

### Ambient temperature

- Default: -40 to 85 °C (-40 to 185 °F)
- Optional: -50 to 85 °C (-58 to 185 °F)
- Restricted range during operation with LCD-indicator: -20 to 70 °C (-4 to 158 °F)
- Restricted range during operation with explosion-proof design: see corresponding certificate

### Transport- / Storage temperature

-50 to 85 °C (-58 to 185 °F)

### Climate class in accordance with DIN EN 60654-1

Cx -40 to 85 °C (-40 to 185 °F) at 5 to 95 % relative air humidity

### Max. permissible humidity in accordance with IEC 60068-2-30

100 % relative air humidity

### Vibration resistance in accordance with IEC 60068-2-6

10 to 2000 Hz at 5 g, during operation and transport

### Shock resistance in accordance with IEC 60068-2-27

gn = 30, during operation and transport

### IP rating

- Power supply circuit: IP 20
- Measurement current circuit: IP 00 or IP-rating of installation housing

## ... Specification

### Electromagnetic compatibility

#### HART® Communication

Emitted interference and interference immunity in

accordance with IEC EN 61326 and NAMUR NE 21.

The extended requirements according to IEC EN 61326-3-2 are met from HW-Rev. 2.00.

Sensor for tests: Pt100: Measuring range 0 to 100 °C (32 to 212 °F), span 100 K.

Type of test	Testing accuracy	Effect
Burst to signal- / data lines	1 kV	< 0,5 %
	2 kV	DS*
Static discharge **		
• Air discharge	8 kV	No
• Contact discharge	6 kV	No
radiated field, IEC EN 61326-1 and NAMUR NE 21:		
80 MHz to 2.7 GHz	10 V/m	< 0,5 %
2.7 GHz to 6 GHz	3 V/m	< 0,5 %
radiated field, IEC EN 61326-3-1 (from HW-Rev. 2.00):		
80 MHz to 1 GHz	20 V/m	DS*
1.4 GHz to 2 GHz	10 V/m	DS*
2 GHz to 6 GHz	3 V/m	DS*
Coupling		
10 kHz to 80 MHz (from HW-Rev. 2.00)	10 V	< 0,5 %
150 kHz to 80 MHz (before HW-Rev. 2.00)	10 V	< 0,5 %
Surge voltage / line to ground	1 kV	B***
	2 kV	DS*

\* Assessment criterion DS (Defined State) in accordance with IEC EN 61326-3-1 (from HW-Rev. 2.00)

\*\* Air discharge (at 1 mm (0.04 in) distance) in accordance with IEC 61000-4-2

\*\*\* Assessment criterion B in accordance with IEC EN 61326-1 and NAMUR NE 21.

#### PROFIBUS PA® and FOUNDATION Fieldbus® communication

Emitted interference and interference immunity in accordance with IEC EN 61326 and NAMUR NE 21.

Sensor for tests: Pt100: Measuring range 0 to 100 °C (32 to 212 °F), span 100 K

Type of test	Testing accuracy	Effect
Burst to signal- / data lines	2 kV	< 0,5 %
Static discharge		
• Contact plate (indirect)	8 kV	No
• Supply terminals*	6 kV	No
• Sensor terminals*	4 kV	No
Radiated field		
80 MHz to 2 GHz	10 V/m	< 0,5 %
Coupling		
150 kHz to 80 MHz	10 V	< 0,5 %
Surge		
between the supply lines	0,5 kV	No malfunction
Line to ground	1 kV	

\* Air discharge (at 1 mm (0.04 in) distance)

### SIL functional safety

Only for devices with HART communication.

With conformity according to IEC 61508 for the use in safety relevant applications up to and including SIL 3 (redundant).

- In the use of one transmitter the device fulfills the requirements according to SIL 2.
- In the use of redundant handled transmitters the requirements can be fulfilled according to SIL 3.

Detailed information can be found in the SIL Safety Manual.

## Type A and type AS LCD indicators

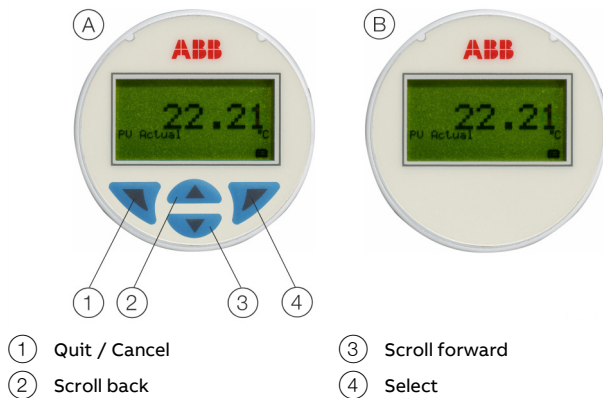

Figure 1: (A) LCD indicator type A (B) LCD indicator type AS

The LCD indicator type AS has a display function; the LCD indicator type A allows additional configuration functions to be carried out.

Both LCD indicators can only be ordered in conjunction with temperature transmitter.

### CE-Marking

The type A and type AS LCD indicator fulfill all requirements for CE marking in accordance with all applicable guidelines.

### Properties

Transmitter-controlled graphic (alphanumeric) LCD indicator

- Character height, mode-dependent
- Sign, 4 digits, 2 decimal places
- Bargraph display
- Turnable in 12 increments of 30° each

### Display options

- Sensor 1 process value
- Sensor 2 process value
- Electronics- / ambient temperature
- Output value
- Output %

Display diagnostic information related to transmitter and sensor status

HART devices from SW-Rev. 3.00 (corresponds to HW-Rev. 2.00 and higher)

- Display of either one or two process values
- Extended diagnosis: error display in plain text with possible remedial actions. Display of multiple simultaneous diagnoses.

### Specification

Temperature range  
-20 to 70 °C (-4 to 158 °F)

Limited display function (contrast, reaction time) in the temperature ranges

- -50 to -20 °C (-58 to -4 °F)  
or
- 70 to 85 °C (158 to 185 °F)

Humidity

0 to 100 %, condensation permitted

### Configuration function

- Sensor configuration for standard sensors
- Measuring range
- Behavior in the event of a fault (HART)
- Software write protection for configuration data
- Device address for HART and PROFIBUS PA

## ... Specification

### Input - resistance thermometer / resistances

#### Resistance thermometer

- Pt100 in accordance with IEC 60751, JIS C1604, MIL-T-24388
- Ni in accordance with DIN 43760
- Cu in accordance with recommendation OIML R 84

#### Resistance measurement

- 0 to 500  $\Omega$
- 0 to 5000  $\Omega$

#### Sensor connection type

Two-, three-, four-wire circuit

#### Connection lead

- Maximum sensor line resistance per line 50  $\Omega$  in accordance with NE 89
- Three-wire circuit: Symmetrical sensor line resistances
- Two-wire circuit: Compensation up to 100  $\Omega$  total lead resistance

#### Measurement current

< 300  $\mu$ A

#### Sensor short circuit

< 5  $\Omega$  (for resistance thermometer)

#### Sensor wire break

- Measuring range: 0 to 500  $\Omega$  > 0.6 to 10 k $\Omega$
- Measuring range: 0 to 5  $\Omega$  > 5.3 to 10 k $\Omega$

#### Detection of sensor wire break in accordance with NE 89 in all lines

#### Sensor error signaling

- Resistance thermometer: Sensor short circuit and sensor wire break
- Linear resistance measurement: Sensor wire break

### Input - thermocouples / voltages

#### Types

- B, E, J, K, N, R, S, T in accordance with IEC 60584
- U, L in accordance with DIN 43710
- C in accordance with IEC 60584 / ASTM E988
- D in accordance with ASTM E988

#### Voltages

- -125 to 125 mV
- -125 to 1100 mV

#### Connection lead

- Maximum sensor line resistance: per line 1.5 k $\Omega$ , total 3 k $\Omega$

#### Detection of sensor wire break in accordance with NE 89 in all lines

#### Input resistance

> 10 M $\Omega$

#### Internal reference junction Pt1000, IEC 60751 Cl. B

(no additional jumpers necessary)

#### Sensor error signaling

- Thermocouple: Sensor wire break
- Linear voltage measurement: Sensor wire break

### Functionality input

#### Freestyle characteristic / 32-points-sampling point table

- Resistance measurement up to a maximum of 5 k $\Omega$
- Voltages up to maximum 1.1 V

#### Sensor error adjustment

- Through Callendar-Van Dusen coefficients
- Through value table, 32 support points
- Through single-point adjustment (offset adjustment)
- Through two-point adjustment

#### Input functionality

- 1 Sensor
- 2 Sensors: mean measurement, differential measurement, sensor redundancy, Sensor drift monitoring

## HART® output

### Transmission characteristics

- Temperature linear
- Resistance linear
- Voltage linear

### Output signal

- Configurable 4 to 20 mA (standard)
- Configurable 20 to 4 mA  
(Dynamic range: 3.8 to 20.5 mA in accordance with NE 43)

### Simulation mode

3.5 to 23.6 mA

### Induced current consumption

< 3,5 mA

### Maximum output current

23.6 mA

### Configurable error current signal

#### Note

Regardless of the alarm setting (underrange or overrange), a high alarm or low alarm is always generated for some internal device errors (e.g. hardware errors). More detailed information can be found in the SIL Safety Manual.

#### Before SW-Rev. 3.00

#### Note

The default factory setting for the error current signal is high alarm 22 mA.

- Overrange / high alarm 22 mA (20.0 to 23.6 mA)
- Underrange / low alarm 3.6 mA (3.5 to 4.0 mA)

#### From SW-Rev. 3.00

#### Note

The default factory setting for the error current signal is low alarm 3.5 mA, in accordance with NAMUR recommendations NE 93, NE 107 and NE 131.

- Overrange / high alarm 22 mA (20.0 to 23.6 mA)
- Underrange / low alarm 3.5 mA (3.5 to 4.0 mA)

## PROFIBUS PA® output

### Output signal

- PROFIBUS – MBP (IEC 61158-2)
- Baud rate 31.25 kBit/s
- PA-Profile 3.01
- FISCO compliant (IEC 60079-27)
- ID-Number: 0x3470 [0x9700]

### Error current signal

- FDE (Fault Disconnection Electronic)

### Block structure

- Physical Block
- Transducer Block 1 – Temperature
- Transducer Block 2 – HMI (LCD indicator)
- Transducer Block 3 – enhanced diagnosis
- Analog Input 1 – Primary Value (Calculated Value\*)
- Analog Input 2 – SECONDARY VALUE\_1 (Sensor 1)
- Analog Input 3 – SECONDARY VALUE\_2 (Sensor 2)
- Analog Input 4 – SECONDARY VALUE\_3 (reference junction temperature)
- Analog Output – optional HMI display (Transducer Block 2)
- Discrete Input 1 – extended diagnosis 1 (Transducer Block 3)
- Discrete Input 2 – extended diagnosis 2 (Transducer Block 3)

\* Sensor 1, Sensor 2 or difference or mean

For detailed information see the PROFIBUS PA® interface description (COM/TTX300/PB).

## ... Specification

### FOUNDATION Fieldbus® output

#### Output signal

- FOUNDATION Fieldbus H1 (IEC 611582-2)
- Baud rate 31.25 kBit/s, ITK 5.x
- ITK 6.x from SW-Rev. 1.02.00 (see interface description FOUNDATION Fieldbus, COM/TTX300/FF)
- FISCO compliant (IEC 60079-27)
- Device ID: 000320001F...

#### Error current signal

- FDE (Fault Disconnection Electronic)

#### Block structure\*

- Resource Block
- Transducer Block 1 – Temperature
- Transducer Block 2 – HMI (LCD indicator)
- Transducer Block 3 – enhanced diagnosis
- Analog Input 1 – PRIMARY\_VALUE\_1 (Sensor 1)
- Analog Input 2 – PRIMARY\_VALUE\_2 (Sensor 2)
- Analog Input 3 – PRIMARY\_VALUE\_3 (Calculated Value\*\*)
- Analog Input 4 – SECONDARY\_VALUE (reference junction temperature)
- Analog Output – optional HMI display (Transducer Block 2)
- Discrete Input 1 – extended diagnosis 1 (Transducer Block 3)
- Discrete Input 2 – extended diagnosis 2 (Transducer Block 3)
- PID – PID controller

#### LAS (Link Active Scheduler) link master functionality

\* For the block description, block index, execution times, and block class, refer to the interface description

\*\* Sensor 1, Sensor 2 or difference or mean

### Power supply

Two-wire technology, polarity safe; power supply lines = signal lines

#### Note

Following calculations apply for standard applications. This should be taken into consideration when working with a higher maximum current.

#### Power supply – HART®

##### Input terminal voltage

- Non-Ex application:  
 $U_s = 11$  to 42 V DC
- Ex applications:  
 $U_s = 11$  to 30 V DC

#### Maximum permissible residual ripple for input terminal voltage

During communication this complies with the HART FSK 'Physical Layer' specification.

#### Undervoltage detection on the transmitter

If the terminal voltage on the transmitter down-scales a value of 10 V, this may lead to an output current of  $I_a \leq 3.6$  mA.

#### Maximum load

$$R_B = (\text{supply voltage} - 11 \text{ V}) / 0.022 \text{ A}$$

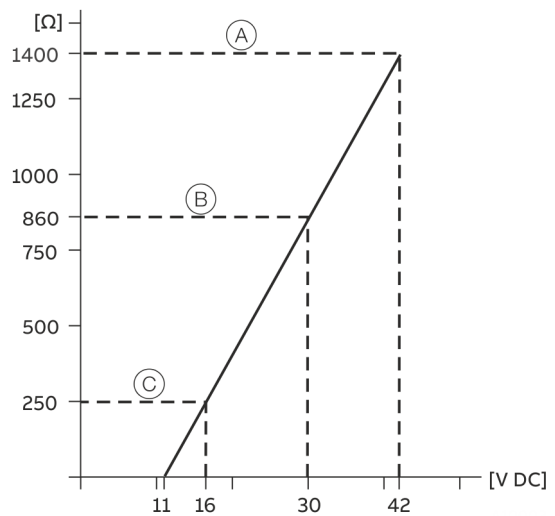

(A) TTH300

(B) TTH300 in Ex-applications

(C) HART communication resistance

Figure 2: Maximum load depending on input terminal voltage

#### Maximum power

$$P = U_s \times 0.022 \text{ A}$$

$$\text{E. G.: } U_s = 24 \text{ V} \rightarrow P_{\text{max}} = 0.528 \text{ W}$$

#### Power supply – PROFIBUS® / FOUNDATION Fieldbus®

##### Input terminal voltage

- Non-Ex application:  
 $U_s = 9$  to 32 V DC
- Ex-applications:  
 $U_s = 9$  to 17,5 V DC (FISCO)  
 $U_s = 9$  to 24 V DC (Fieldbus Entity model I.S.)

##### Current consumption

$$\leq 12 \text{ mA}$$



## Measuring accuracy

Includes linearity error, repeatability / hysteresis at 23 °C (73.4 °F) ± 5 K and 20 V supply voltage.

Information on measuring accuracy corresponds to 3  $\sigma$  (Gaussian distribution).

Long-term drift: ±0.05 °C (±0.09 °F) or ±0.05 %\* per year, the larger value applies.

Sensor	Measurement range limits	Minimum span	Measuring accuracy		
			Input (24-bit AD-converter)	Analog output* (16-Bit D / A-converter)	
<b>Resistance thermometer / resistor</b>					
DIN IEC 60751	Pt10 (a=0.003850)	-200 to 850 °C (-328 to 1562 °F)	10 °C (18 °F)	±0.80 °C (±1.44 °F)	±0.05%
	Pt50 (a=0.003850)			±0.16 °C (±0.29 °F)	±0.05%
	Pt100 (a=0.003850)**			±0.08 °C (±0.14 °F)	±0.05%
	Pt200 (a=0.003850)			±0.40 °C (±0.72 °F)	±0.05%
	Pt500 (a=0.003850)			±0.16 °C (±0.29 °F)	±0.05%
	Pt1000 (a=0.003850)			±0.08 °C (±0.14 °F)	±0.05%
JIS C1604	Pt10 (a=0.003916)	-200 to 645 °C (-328 to 1193 °F)	10 °C (18 °F)	±0.80 °C (±1.44 °F)	±0.05%
	Pt50 (a=0.003916)			±0.16 °C (±0.29 °F)	±0.05%
	Pt100 (a=0.003916)			±0.08 °C (±0.14 °F)	±0.05%
MIL-T-24388	Pt10 (a=0.003920)	-200 to 850 °C (-328 to 1562 °F)	10 °C (18 °F)	±0.80 °C (±1.44 °F)	±0.05%
	Pt50 (a=0.003920)			±0.16 °C (±0.29 °F)	±0.05%
	Pt100 (a=0.003920)			±0.08 °C (±0.14 °F)	±0.05%
	Pt200 (a=0.003920)			±0.40 °C (±0.72 °F)	±0.05%
	Pt1000 (a=0.003920)			±0.08 °C (±0.14 °F)	±0.05%
DIN 43760	Ni50 (a=0.006180)	-60 to 250 °C (-76 to 482 °F)	10 °C (18 °F)	±0.16 °C (±0.29 °F)	±0.05%
	Ni100 (a=0.006180)			±0.08 °C (±0.14 °F)	±0.05%
	Ni120 (a=0.006180)				±0.05%
	Ni1000 (a=0.006180)				±0.05%
OIML R 84	Cu10 (a=0.004270)	-50 to 200 °C (-58 to 392 °F)	10 °C (18 °F)	±0.80 °C (±1.44 °F)	±0.05%
	Cu100 (a=0.004270)			±0.08 °C (±0.14 °F)	±0.05%
	Resistance measurement	0 to 500 $\Omega$	4 $\Omega$	±32 m $\Omega$	±0.05%
		0 to 5000 $\Omega$	40 $\Omega$	±320 m $\Omega$	±0.05%

\* Percentages refer to the configured measuring span, omitted for PROFIBUS PA® and FOUNDATION Fieldbus®

\*\* Standard Version

## ... Specification

Sensor	Measurement range limits	Minimum span	Measuring accuracy		
			Input* (24-bit AD-converter)	Analog output** (16-Bit D / A-converter)	
<b>Thermocouples*** / voltages</b>					
IEC 60584	Type K (Ni10Cr-Ni5)	-200 to 1372 °C (-328 to 2502 °F)	50 °C (90 °F)	±0.35 °C (±0.63 °F)	±0.05%
	Type J (Fe-Cu45Ni)	-210 to 1200 °C (-346 to 2192 °F)			±0.05%
	Type N (Ni14CrSi-NiSi)	-200 to 1300 °C (-328 to 2372 °F)			±0.05%
	Type T (Cu-Cu45Ni)	-200 to 400 °C (-328 to 752 °F)			±0.05%
	Type E (Ni10Cr-Cu45Ni)	-200 to 1000 °C (-328 to 1832 °F)			±0.05%
	Type R (Pt13Rh-Pt)	-50 to 1768 °C (-58 to 3215 °F)	100 °C (180 °F)	±0.95 °C (±1.71 °F)	±0.05%
	Type S (Pt10Rh-Pt)			±1.15 °C (±2.07 °F)	±0.05%
DIN 43710	Type B (Pt30Rh-Pt6Rh)	250 to 1820 °C (482 to 3308 °F)		±1.05 °C (±1.89 °F)	±0.05%
	Type L (Fe-CuNi)	-200 to 900 °C (-328 to 1652 °F)	50 °C (90 °F)	±0.35 °C (±0.63 °F)	±0.05%
IEC 60584 / ASTM E988	Type U (Cu-CuNi)	-200 to 600 °C (-328 to 1112 °F)			±0.05%
	Type C	0 to 2315 °C (32 to 4200 °F)	100 °C (180 °F)	±1.35 °C (±2.43 °F)	±0.05%
ASTM E988	Type D				±0.05%
	Voltage measurement	-125 to 125 mV	2 mV	±12 µV	±0.05%
		-125 to 1100 mV	20 mV	±120 µV	±0.05%

\* Due to the physical properties of thermocouples, the accuracy of temperature measurement decreases at low temperatures and may then be outside the specified accuracy range at the input. The specified accuracy applies to

Type K: > -60 °C, type J: > -140 °C, type N: >250 °C, type T: > -40 °C, type E: > -150 °C,

Type R: >860 °C (400 to 860 °C: ±1.15 °C), type S: >650 °C (250 to 650 °C: ±1.36 °C),

Type B: >1440 °C (500 to <1000 °C: ±2.4 °C, 1000 to 1440 °C: ±1.32 °C)

Type L: > -140 °C (≤ -140 °C: ±0.41 °C), type U: > -40 °C (≤ -40 °C: ±0.63 °C),

Type C and type D: no restriction

Type K: > -76 °F, type J: > -220 °F, type N: >482 °F, type T: > -40 °F, type E: > -238 °F,

Type R: >1580 °F (752 to 1580 °F: ±2.07 °F), type S: >1202 °F (482 to 1202 °F: ±2.45 °F),

Type B: >2624 °F (932 to <1832 °F: ±4.32 °F, 1832 to 2624 °F: ±2.38 °F)

Type L: > -220 °F (≤ -220 °F: ±0.74 °F), type U: > -40 °F (≤ -40 °F: ±1.13 °F),

\*\* Percentages refer to the configured measuring span, omitted for PROFIBUS PA® and FOUNDATION Fieldbus®

\*\*\* For digital measuring accuracy, the internal reference junction error must be added: Pt1000, DIN IEC 60751 Cl. B

## Operating influence

The percentages refer to the configured measuring span.

Input terminal voltage effect / load effect:

Within the specified limit values for the voltage / load, the total influence is less than 0.001 % per volt.

Common-mode interference

No influence up to 100 V<sub>eff</sub> (50 Hz) or 50 VDC

Ambient temperature influence:

Based on 23 °C (73.4 °F) for an ambient temperature range of -40 to 85 °C (-40 to 185 °F)<sup>1</sup>

Sensor		Ambient temperature effect per 1 °C (1.8 °F) deviation from 23 °C (73.4 °F)	
		Input <sup>2</sup> (24-bit A / D converter)	Analog output <sup>3, 4</sup> (16 bit DA-converter)
<b>Resistance thermometer for two-, three- and four-wire circuits</b>			
IEC, JIS, MIL	Pt10	±0,04 °C (±0.072 °F)	±0.003%
	Pt50	±0.008 °C (±0.014 °F)	±0.003%
	Pt100	±0.004 °C (±0.007 °F)	±0.003%
IEC, MIL	Pt200	±0.02 °C (±0.036 °F)	±0.003%
	Pt500	±0.008 °C (±0.014 °F)	±0.003%
	Pt1000	±0.004 °C (±0.007 °F)	±0.003%
DIN 43760	Ni50	±0.008 °C (±0.014 °F)	±0.003%
	Ni100	±0.004 °C (±0.007 °F)	±0.003%
	Ni120	± 0.003 °C (± 0.005 °F)	±0.003%
	Ni1000	±0.004 °C (±0.007 °F)	±0.003%
OIML R 84	Cu10	±0,04 °C (±0.072 °F)	±0.003%
	Cu100	±0.004 °C (±0.007 °F)	±0.003%
<b>Resistance measurement</b>			
	0 to 500 Ω	±0.002 Ω	±0.003%
	0 to 5000 Ω	±0.02 Ω	±0.003%
<b>Thermocouple, for all defined types</b>			
		± [(0.001 % × (ME[mV] / MS[mV]) + (100 % × (0.009 °C / MS [°C]))] <sup>5</sup>	±0.003%
<b>Voltage measurement</b>			
	-125 to 125 mV	±1.5 μV	±0.003%
	-125 to 1100 mV	±15 μV	±0.003%

1 For the optionally extended ambient temperature range down to -50 °C (-58 °F), twice the influence values apply in the range from -50 to -40 °C (-58 to -40 °F)

2 Typical values

3 Percentages refer to the configured measuring span of the analog output signal

4 Influence D / A converter not applicable for PROFIBUS PA® and FOUNDATION Fieldbus®

5 Percentages refer to the configured measuring span

ME = voltage value of the thermocouple at the upper range value in accordance with the standard

MA = voltage value of the thermocouple at the lower range value in accordance with the standard

MS = voltage value of the thermocouple over the measuring span in accordance with the standard. MS = (ME - MA)

## Electrical connections

### Terminal assignment

#### Resistance thermometers (RTD) / resistors (potentiometer)

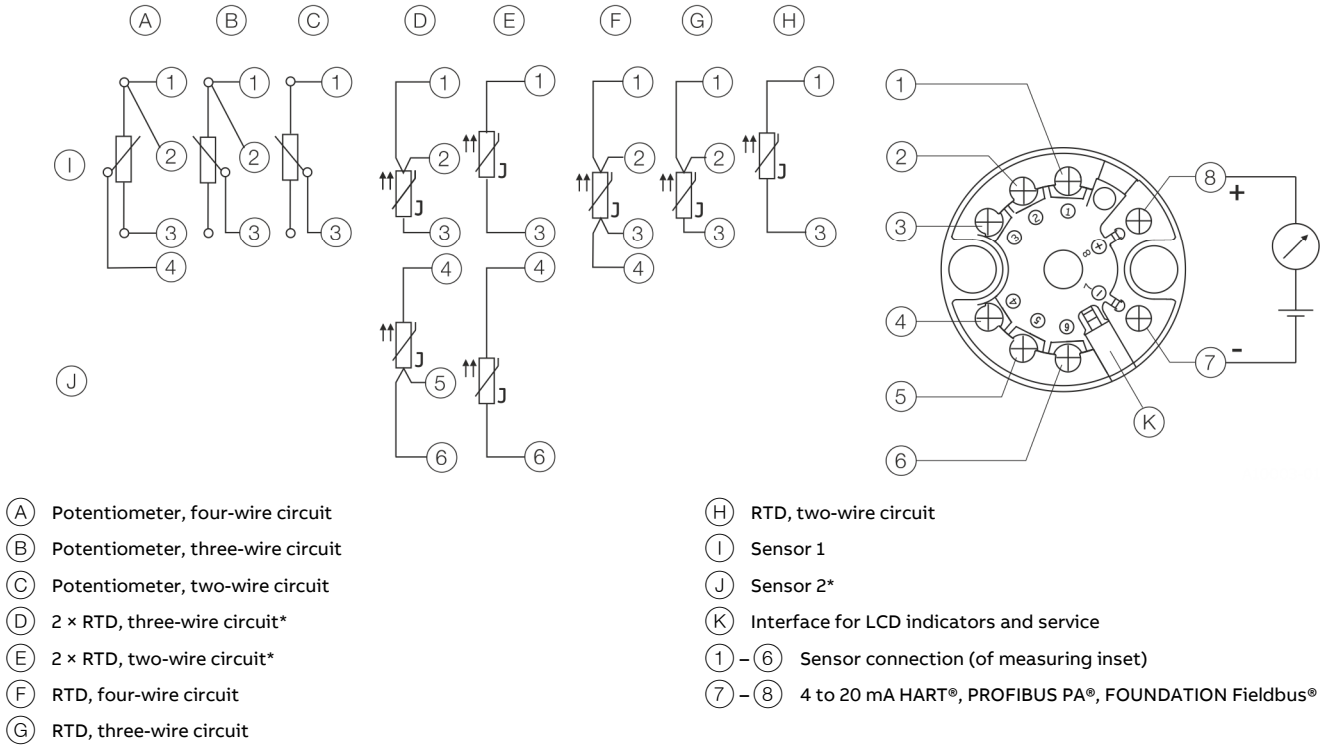

\* Sensor backup / sensor redundancy, sensor drift monitoring, mean measurement, or differential measurement

Figure 3: Terminal assignment resistance thermometers (RTD) / resistors (potentiometer)

**Thermocouples / voltages and resistance thermometer (RTD) / thermocouple combinations**

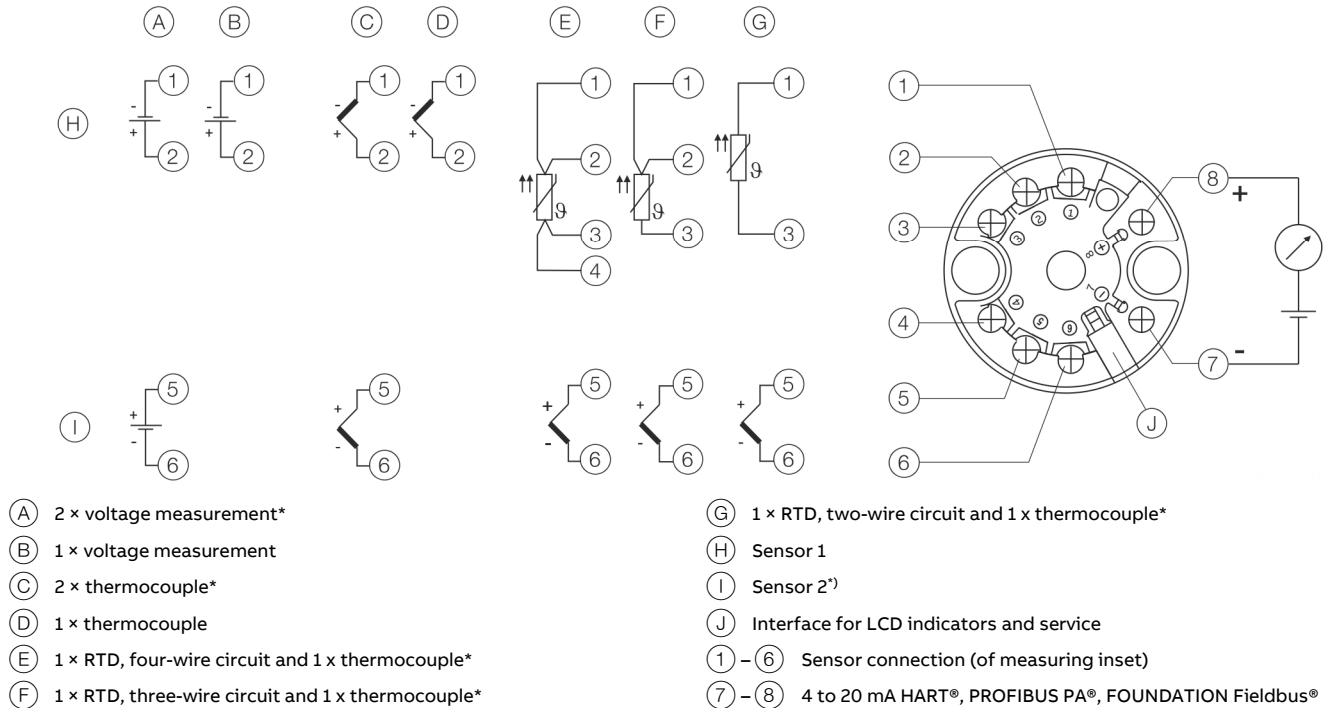

\* Sensor backup / sensor redundancy, sensor drift monitoring, mean measurement, or differential measurement

**Figure 4 Terminal assignment thermocouples / voltages and resistance thermometer (RTD) / thermocouple combinations**

## Communication

### Configuration parameters

#### Measurement type

- Sensor type, connection type
- Error signaling
- Measuring range
- General information, e.g. TAG number
- Damping
- Warning and alarm thresholds
- Output signal simulation
- For details, see **Order form configuration** on page 24.

#### Write protection

Software write protection

#### Diagnostic information in accordance with NE 107

Standard:

- Sensor error signalling (wire break or short-circuit)
- Device error
- Limit value up- / down-scaled
- Upper range up- / down-scaled
- Simulation active

Advanced:

- Sensor redundancy / sensor backup active (in case sensor fails) with configurable analog alarm pulse signaling

From SW-Rev. 3.00: Redundancy configurable via tools for:

- Increased availability (default setting for redundancy),
- increased safety,
- increased accuracy (average value output)
- Drift monitoring
- Configurable alarm pulse signaling
- Sensor- / sensor connection lead corrosion
- Supply voltage down-scaled
- Drag indicator for Sensor 1, Sensor 2 and ambient temperature
- Ambient temperature up-scaled
- Ambient temperature down-scaled
- Operating hours counter

### HART® Communication

The device is listed with the FieldComm Group.

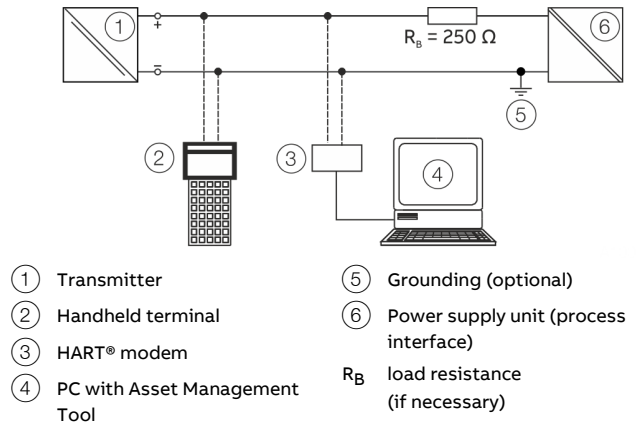

Figure 5: Example for HART® connection

Manufacturer ID	0x1A
Device ID	HART 5: 0x000B, HART 7: 0x1A0B
Profile	From SW-Rev. 3.00 (corresponds to HW-Rev. 2.00 and higher): HART 5.9 and HART 7.6, switchable via <ul style="list-style-type: none"> <li>• HMI LCD indicator with configuration function</li> <li>• Tools</li> <li>• HART commands</li> </ul> Default, if nothing else ordered: HART 7.6.  SW-Rev. 1.03: HART 5.1 and HART 7, switchable via DIP switch. Default, if nothing else ordered: HART 5.1.  SW-Rev. 1.01.08: HART 5.1, previously HART 5.
Configuration	On device using LCD indicator DTM, EDD, FDI (FIM)
Transmission signal	BELL Standard 202

**Operating modes**

- Point-to-point communication mode – standard (general address 0)
- HART 5: Multidrop mode (addressing 1 to 15)
- HART 7: Addressing 0 to 63, independent of current loop mode
- Burst Mode

**Configuration options / tools**

Driver-independent:

- HMI LCD indicator with configuration function

Driver-dependent:

- Device management / Asset management tools
- FDT technology – via TTX300-DTM driver (Asset Vision Basic / DAT200)
- EDD – via TTX300 EDD driver (Handheld terminal, Field Information Manager / FIM)
- FDI technology – via TTX300 package (Field Information Manager / FIM)

**Diagnosis notice**

- Overrange- / underrange in accordance with NE 43
- HART® diagnosis

Extended from SW-Rev. 3.00

- Device status signaling according to NE 107
- Freely configurable diagnostic categorization with diagnostic history according to NE 107

**Tracking of events and configuration changes, from SW-Rev. 3.00**

The HART® device stores information on critical events and configuration changes.

The information can be output via tools:

- Event monitor for logging critical events
- Configuration monitor for configuration changes

See the interface description HART® (COM/TTX300/HART) for details.

## ... Communication

### PROFIBUS PA® Communication

The interface conforms to Profile 3.01 (standard PROFIBUS®, EN 50170, DIN 1924 [PRO91]).

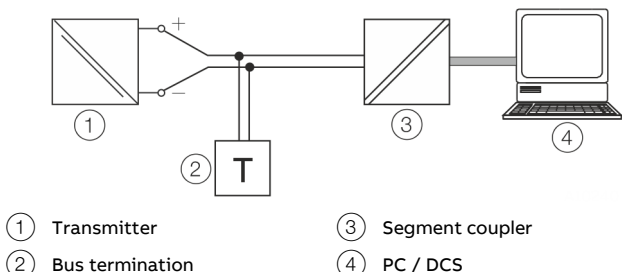

Figure 6: Example for PROFIBUS PA® connection

Manufacturer ID	0x1A
ID number	0x3470 [0x9700]
Profile	PA 3.01 (see interface description PROFIBUS PA® (COM/TTX300/PB))
Configuration	On device using LCD indicator
	DTM
	EDD
	GSD
Transmission signal	IEC 61158-2

#### Voltage / current consumption

- Mean current consumption: 12 mA.  
 In the event of an error, the FDE function (= Fault Disconnection Electronic) integrated in the device makes sure that the current consumption cannot exceed a maximum of 20 mA.

### FOUNDATION Fieldbus® Communication

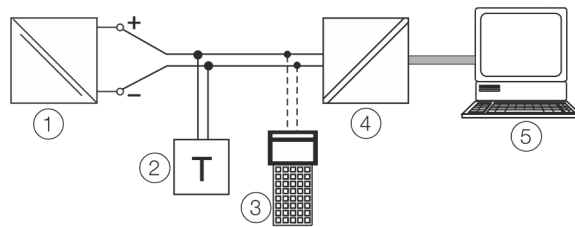

- ① Transmitter
- ② Bus termination
- ③ Handheld terminal
- ④ Linking Device
- ⑤ PC / DCS

Figure 7: Example for FOUNDATION Fieldbus® connection

Device ID	000320001F...
ITK	5.x
ITC from SW-Rev. 1.02.00	6.x (see FOUNDATION Fieldbus® interface description (COM/TTX300/FF))
Configuration	On device using LCD indicator
	EDD
Transmission signal	IEC 61158-2

#### Voltage / current consumption

- Mean current consumption: 12 mA.  
 In the event of an error, the FDE function (= Fault Disconnection Electronic) integrated in the device makes sure that the current consumption cannot exceed a maximum of 20 mA.



## Dimensions

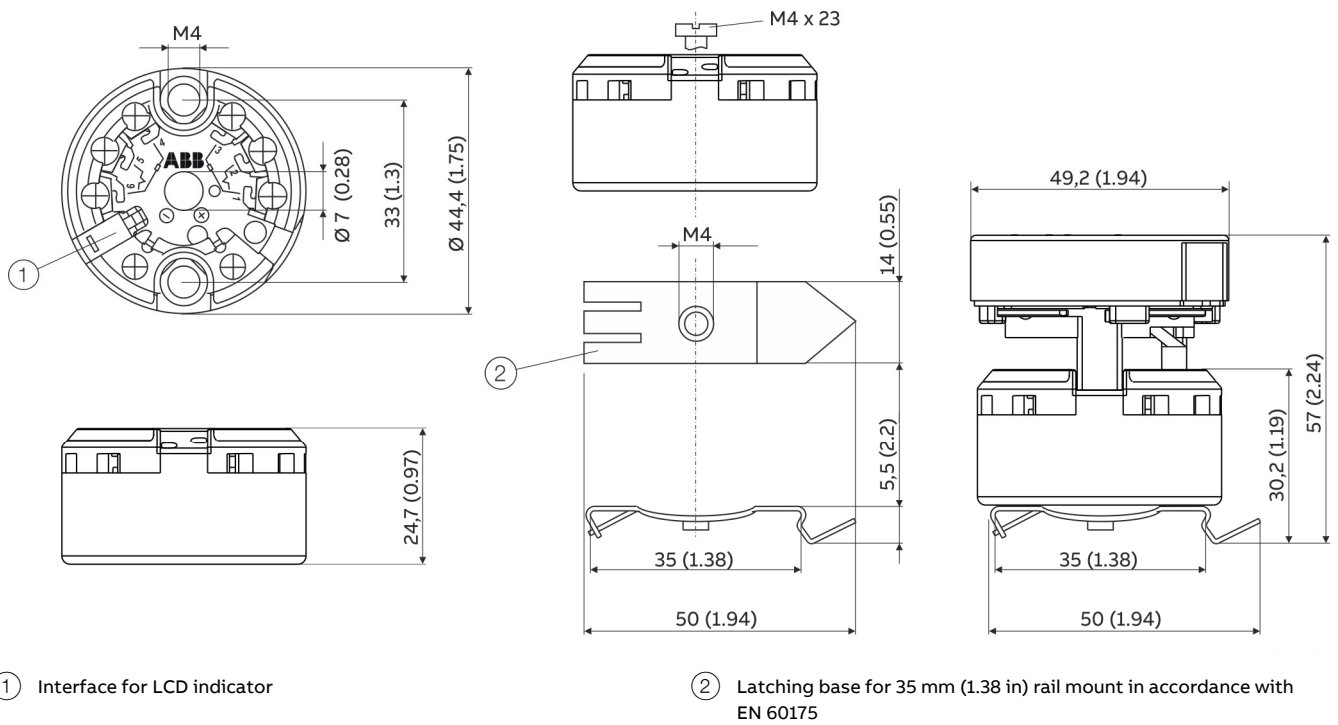

Figure 8: Dimensions in mm (in)

## Use in potentially explosive atmospheres in accordance with ATEX and IECEx

### Note

- Further information on the approval of devices for use in potentially explosive atmospheres can be found in the explosion protection test certificates (at [www.abb.com/temperature](http://www.abb.com/temperature)).
- Depending on the design, a specific marking in accordance with ATEX or IECEx applies.

### Ex marking

#### Transmitter

##### ATEX intrinsic safety

The device fulfills the requirements of Directive 2014/34/EU in case of corresponding purchase orders and is approved for use in Zone 0, 1 and 2.

#### Model TTH300-E1H

To HW-Rev. 1.07:

Type Examination Test Certificate PTB 05 ATEX 2017 X

From HW Rev. 02.00.00:

Type Examination Test Certificate PTB 20 ATEX 2008 X

#### Model TTH300-E1P and TTH300-E1F

Type Examination Test Certificate PTB 09 ATEX 2016 X

II 1 G Ex ia IIC T6...T1 Ga

II 2 (1) G Ex [ja IIC Ga] ib IIC T6...T1 Gb

II 2 G (1D) Ex [ja IIIC Da] ib IIC T6...T1 Gb

##### ATEX non-sparking and increased safety

The device fulfills the requirements of Directive 2014/34/EU in case of corresponding purchase orders and is approved for use in Zone 2.

#### Model TTH300-E2

Declaration of conformity

II 3 G Ex nA IIC T6...T1 Gc

II 3 G Ex ec IIC T6...T1 Gc

##### IECEx intrinsic safety

Approved for use in Zone 0, 1, and 2.

#### Model TTH300-H1H

To HW-Rev. 1.07:

IECEx certificate of conformity IECEx PTB 09.0014X

From HW Rev. 02.00.00:

IECEx certificate of conformity IECEx PTB 20.0035X

#### Model TTH300-H1P and TTH300-H1F

IECEx certificate of conformity IECEx PTB 11.0108X

Ex ia IIC T6...T1 Ga

Ex [ja IIC Ga] ib IIC T6...T1 Gb

Ex [ja IIIC Da] ib IIC T6...T1 Gb

### LCD indicator

#### ATEX intrinsic safety

The device fulfills the requirements of Directive 2014/34/EU in case of corresponding purchase orders and is approved for use in Zone 0, 1 and 2.

Type Examination Test Certificate

PTB 05 ATEX 2079 X

II 1G Ex ia IIC T6...T1 Ga

#### ATEX non-sparking and increased safety

The device fulfills the requirements of Directive 2014/34/EU in case of corresponding purchase orders and is approved for use in Zone 2.

Declaration of conformity

II 3 G Ex nA IIC T6...T1 Gc

II 3 G Ex ec IIC T6...T1 Gc

#### IECEx intrinsic safety

Approved for use in Zone 0, 1, and 2.

IECEx certificate of conformity

IECEx PTB 12.0028X

Ex ia IIC T6...T1 Ga

### Temperature data

#### Transmitter

##### ATEX / IECEx intrinsic safety, ATEX non-sparking and increased safety

Temperature class	Permissible ambient temperature range
T6	-50 to 56 °C (-58 to 132.8 °F)
T4-T1	-50 to 85 °C (-58 to 185.0 °F)

### LCD indicator

##### ATEX / IECEx intrinsic safety, ATEX non-sparking and increased safety

Temperature class	Permissible ambient temperature range
T6	-50 to 56 °C (-58 to 132.8 °F)
T4-T1	-50 to 85 °C (-58 to 185 °F)

## Electrical data

### Transmitter

#### Intrinsic safety type of protection Ex ia IIC (part 1)

	TTH300-E1H		TTH300-E1P/-H1P
	TTH300-H1H		TTH300-E1F/-H1F
	FISCO <sup>1</sup>		ENTITY
Max. voltage	$U_i = 30 \text{ V}$		$U_i \leq 24.0 \text{ V}$
Short-circuit current	$I_i = 130 \text{ mA}$		$I_i \leq 250 \text{ mA}$
Max. power	$P_i = 0.8 \text{ W}$		$P_i \leq 1.2 \text{ W}$
Internal inductance	$L_i = 160 \mu\text{H}^3$		$L_i \leq 10 \mu\text{H}$
Internal capacitance	$C_i = 0.57 \text{ nF}^4$		$C_i \leq 5 \text{ nF}$

- 1 FISCO according to 60079-27
- 2 II B FISCO:  $I_i \leq 380 \text{ mA}$ ,  $P_i \leq 5.32 \text{ W}$
- 3 For HART variant only. From Hardware Rev. 02.00.00, previously 0.5 mH
- 4 For HART variant only. From hardware revision 1.07, previously 5 nF

#### Intrinsic safety type of protection Ex ia IIC (part 2)

##### TTH300-E1H, TTH300-H1H

	Resistance	Thermocouples,
	thermometers,	voltages
	resistors	
Max. voltage	$U_o = 6.5 \text{ V}$	$U_o = 1.2 \text{ V}$
Short-circuit current	$I_o = 17.8 \text{ mA}^*$	$I_o = 50 \text{ mA}$
Max. power	$P_o = 29 \text{ mW}^{**}$	$P_o = 60 \text{ mW}$
Internal inductance	$L_i \approx 0 \text{ mH}$ (negligible)	$L_i \approx 0 \text{ mH}$ (negligible)
Internal capacitance	$C_i = 49 \text{ nF}$	$C_i = 49 \text{ nF}$
Maximum permissible external inductance	$L_o = 5 \text{ mH}$	$L_o = 5 \text{ mH}$
Maximum permissible external capacitance	$C_o = 1.55 \mu\text{F}$	$C_o = 1.05 \mu\text{F}$

\* From Hardware Rev. 02.00.00, previously 25 mA

\*\* From Hardware Rev. 02.00.00, previously 38 mW

#### Intrinsic safety type of protection Ex ia IIC (part 2)

##### TTH300-E1P, TTH300-H1P, TTH300-E1F, TTH300-H1F

	Resistance	Thermocouples,
	thermometers,	voltages
	resistors	
Max. voltage	$U_o = 6.5 \text{ V}$	$U_o = 1.2 \text{ V}$
Short-circuit current	$I_o = 25 \text{ mA}$	$I_o = 50 \text{ mA}$
Max. power	$P_o = 38 \text{ mW}$	$P_o = 60 \text{ mW}$
Internal inductance	$L_i \approx 0 \text{ mH}$ (negligible)	$L_i \approx 0 \text{ mH}$ (negligible)
Internal capacitance	$C_i = 49 \text{ nF}$	$C_i = 49 \text{ nF}$
Maximum permissible external inductance	$L_o = 5 \text{ mH}$	$L_o = 5 \text{ mH}$
Maximum permissible external capacitance	$C_o = 1.55 \mu\text{F}$	$C_o = 1.05 \mu\text{F}$

#### Intrinsic safety type of protection Ex ia IIC (part 3)

##### LCD indicator interface

Max. voltage	$U_o = 6.2 \text{ V}$
Short-circuit current	$I_o = 65.2 \text{ mA}$
Max. power	$P_o = 101 \text{ mW}$
Internal inductance	$L_i \approx 0 \text{ mH}$ (negligible)
Internal capacitance	$C_i \approx 0 \text{ nF}$ (negligible)
Maximum permissible external inductance	$L_o = 5 \text{ mH}$
Maximum permissible external capacitance	$C_o = 1.4 \mu\text{F}$

##### LCD indicator

#### Intrinsic safety type of protection Ex ia IIC

Supply circuit	
Max. voltage	$U_i = 9 \text{ V}$
Short-circuit current	$I_i = 65.2 \text{ mA}$
Max. power	$P_i = 101 \text{ mW}$
Internal inductance	$L_i \approx 0 \text{ mH}$ (negligible)
Internal capacitance	$C_i \approx 0 \text{ nF}$ (negligible)

## Use in potentially explosive atmospheres in accordance with FM and CSA

### Note

- Further information on the approval of devices for use in potentially explosive atmospheres can be found in the explosion protection test certificates (at [www.abb.com/temperature](http://www.abb.com/temperature)).
- Depending on the design, a specific marking in accordance with FM or CSA applies.

## Ex marking

### Transmitter

#### FM Intrinsically Safe

##### Model TTH300-L1H

To HW-Rev. 1.07:	
Control Drawing	SAP_214829
From HW Rev. 02.00.00:	
Control Drawing	See attached information

##### Model TTH300-L1P

Control Drawing	TTH300-L1P (IS)
-----------------	-----------------

##### Model TTH300-L1F

Control Drawing	TTH300-L1F (IS)
Class I, Div. 1 + 2, Groups A, B, C, D	
Class I, Zone 0, AEx ia IIC T6	

#### FM Non-Incendive

##### Model TTH300-L2H

To HW-Rev. 1.07:	
Control Drawing	214831 (Non-Incendive)
From HW Rev. 02.00.00:	
Control Drawing	See attached information

##### Model TTH300-L2P

Control Drawing	TTH300-L2P (NI_PS)
	TTH300-L2P (NI_AA)

##### Model TTH300-L2F

Control Drawing	TTH300-L2F (NI_PS)
	TTH300-L2F (NI_AA)

Class I, Div. 2, Groups A, B, C, D

#### CSA Intrinsically Safe

##### Model TTH300-R1H

To HW-Rev. 1.07:	
Control Drawing	214826
From HW Rev. 02.00.00:	
Control Drawing	See attached information

##### Model TTH300-R1P

Control Drawing	TTH300-R1P (IS)
-----------------	-----------------

##### Model TTH300-R1F

Control Drawing	TTH300-R1F (IS)
-----------------	-----------------

Class I, Div. 1 + 2, Groups A, B, C, D

Class I, Zone 0, Ex ia IIC T6

#### CSA Non-Incendive

##### Model TTH300-R2H

To HW-Rev. 1.07:	SAP_214824 (Non-Incendive)
Control Drawing	SAP_214896 (Non-Incendive)

From HW Rev. 02.00.00:

Control Drawing	See attached information
-----------------	--------------------------

##### Model TTH300-R2P

Control Drawing	TTH300-R2P (NI_PS)
	TTH300-R2P (NI_AA)

##### Model TTH300-R2F

Control Drawing	TTH300-R2F (NI_PS)
	TTH300-R2F (NI_AA)

Class I, Div. 2, Groups A, B, C, D

#### LCD indicator

#### FM Intrinsically Safe

Control Drawing	SAP_214 748
-----------------	-------------

I.S. Class I Div 1 and Div 2, Group: A, B, C, D or

I.S. Class I Zone 0 AEx ia IIC T\*

$$U_i / V_{max} = 9 V, I_i / I_{max} < 65.2 \text{ mA}, P_i = 101 \text{ mW}, C_i = 0.4 \mu\text{F}, L_i = 0$$

#### FM Non-Incendive

Control Drawing	SAP_214 751
-----------------	-------------

N.I. Class I Div 2, Group: A, B, C, D or Ex nL IIC T\*\*, Class I Zone 2

$$U_i / V_{max} = 9 V, I_i / I_{max} < 65.2 \text{ mA}, P_i = 101 \text{ mW}, C_i = 0.4 \mu\text{F}, L_i = 0$$

#### CSA Intrinsically Safe

Control Drawing	SAP_214 749
-----------------	-------------

I.S. Class I Div 1 and Div 2; Group: A, B, C, D or

I.S. Zone 0 Ex ia IIC T\*

$$U_i / V_{max} = 9 V, I_i / I_{max} < 65.2 \text{ mA}, P_i = 101 \text{ mW}, C_i < 0.4 \mu\text{F}, L_i = 0$$

#### CSA Non-Incendive

Control Drawing	SAP_214 750
-----------------	-------------

N.I. Class I Div 2, Group: A, B, C, D or Ex nL IIC T\*\*, Class I Zone 2

$$U_i / V_{max} = 9 V, I_i / I_{max} < 65.2 \text{ mA}, P_i = 101 \text{ mW}, C_i < 0.4 \mu\text{F}, L_i = 0$$

\* Temp. Ident: T6 T<sub>amb</sub> 56 °C, T4 T<sub>amb</sub> 85 °C

\*\* Temp. Ident: T6 T<sub>amb</sub> 60 °C, T4 T<sub>amb</sub> 85 °C

## Ordering Information

### TTH300

Base model	TTH300	XX	X	X
TTH300 Head Mounted Temperature Transmitter, Pt100 (RTD), thermocouples, electrical isolation				
<b>Explosion Protection</b>				
Without explosion protection		Y0		
ATEX Intrinsic Safety type of protection: Zone 0: II 1 G Ex ia IIC T6...T1 Ga, Zone 1 (0): II 2 (1) G Ex [ia IIC Ga] ib IIC T6...T1 Gb, Zone 1 (20): II 2 G (1D) Ex [ia IIIC Da] ib IIC T6...T1 Gb		E1		
ATEX Non-sparking and increased safety type of protection: Zone 2: II 3 G Ex nA IIC T6...T1 Gc, II 3 G Ex ec IIC T6...T1 Gc		E2		
IECEx Intrinsic Safety type of protection: Zone 0: Ex ia IIC T6...T1 Ga, Zone 1 (0): Ex [ia IIC Ga] ib IIC T6...T1 Gb, Zone 1 (20): Ex [ia IIIC Da] ib IIC T6...T1 Gb		H1		
FM Intrinsic Safety (IS): Class I, Div. 1+2, Groups A, B, C, D, Class I, Zone 0, AEx ia IIC T6		L1		
FM Non-incendive (NI): Class I, Div. 2, Groups A, B, C, D or Class I Zone 2 Group IIC T6		L2		
CSA Intrinsic Safety (IS): Class I, Div. 1+2, Groups A, B, C, D, Class I, Zone 0, Ex ia IIC T6		R1		
CSA Non-incendive (NI): Class I, Div. 2, Groups A, B, C, D		R2		
GOST Russia - metrological approval		G1		
GOST Russia - metrological approval and EAC-Ex, Ex i - Zone 0		P2		
GOST Kazakhstan - metrological approval		G3		
GOST Kazakhstan - metrological approval and EAC-Ex, Ex i - Zone 0		T2		
GOST Belarus - metrological approval		M5		
GOST Belarus - metrological approval and EAC-Ex, Ex i - Zone 0		U2		
NEPSI Intrinsic Safety type of protection: Ex ia IIC T6 Ga		S1		
<b>Communication Protocol</b>				
HART			H	
PROFIBUS PA			P	
FOUNDATION Fieldbus			F	
<b>Configuration</b>				
Standard configuration				BS
Customer-specific configuration with report, except user curve				BF*
Customer-specific configuration with report, including user curve				BG

\* E.g. set measuring range, TAG no.

## ... Ordering Information

### Additional ordering information TTH300

Additional ordering information	XX	XX	XXX	XX	XX	XX	XX	XX
<b>Declarations and Certificates</b>								
SIL2 - Declaration of Conformity	CS*							
Declaration of compliance according EN 10204-2.1, with the order	C4							
Inspection certificate according EN 10204-3.1, visual, dimensional and functional test	C6							
<b>Calibration Certificates</b>								
With 5-point factory certificate		EM						
Inspection certificate according EN 10204-3.1, 5-point calibration		EP						
<b>Handling of Certificates</b>								
Send via e-mail			GHE					
Send via mail			GHP					
Send via mail express			GHD					
Send with instrument			GHA					
Only archived			GHS					
<b>Extended Ambient Temperature Range</b>								
-50 to 85 °C (-58 to 185 °F)						SE		
<b>Field Housing</b>								
Aluminium field housing 80 × 75 × 57 mm, IP 65, including 2 pieces M16 cable glands							H1**	
Polyester field housing 75 × 80 × 55 mm, IP 65, including 2 pieces M16 cable glands							H2**	
Polycarbonate field housing 80 × 82 × 55 mm, IP 65, including 2 pieces M16 cable glands							H3**	
Aluminium field housing 175 × 80 × 57 mm without separate terminal block, IP 65, including 2 pieces M16 and 1 piece M20 cable glands							H6**	
Polyester field housing 190 × 75 × 55 mm with separate terminal block, IP 65, including 2 pieces M16 and 1 piece M20 cable glands							H7**	
Polyester field housing 190 × 75 × 55 mm without separate terminal block, IP 65, including 2 pieces M16 and 1 piece M20 cable glands							H8**	
<b>Display Options</b>								
Prepared for display								D1
Not prepared for display								D2
LCD indicator type AS								D3
Configurable LCD indicator type A								D4
<b>Mounting Options</b>								
Snap-on fixing set for 35 mm rail acc. EN 60175 (incl. fixing screws)								SF
<b>Customer-specific Versions</b>								
(Please specify)								Z9

\* Only available with **Communication Protocol** code H (HART)

\*\* Not available with Explosion Protection

<b>Additional ordering information TTH300</b>		<b>XX</b>
<b>Documentation Language</b>		
German		M1
English		M5
Chinese		M6
Language package Western Europe / Scandinavia (Languages: DA, ES, FR, IT, NL, PT, FI, SV)		MW
Language package Eastern Europe (Languages: EL, CS, ET, LV, LT, HU, HR, PL, SK, SL, RO, BG)		ME
<b>Accessories</b>		<b>Order code</b>
TTH Snap-on fixing set (packing unit 10 pieces), for 35 mm rail acc. EN 60175 (incl. fixing screws)		3KXT091230L0001
TTH Snap-on fixing set (packing unit 1 piece), for 35 mm rail acc. EN 60175 (incl. fixing screws)		3KXT091230L0002
TTH300 Commissioning Instruction, German		3KXT231001R4403
TTH300 Commissioning Instruction, English		3KXT231001R4401
TTH300 Commissioning Instruction, Language package Western Europe / Scandinavia		3KXT231001R4493
TTH300 Commissioning Instruction, Language package Eastern Europe		3KXT231001R4494

## Order form configuration

### HART device design

Customer-specific configuration	Selection
Number of sensors	<input type="checkbox"/> 1 sensor (standard) <input type="checkbox"/> 2 sensors
Measurement type (for 2-sensor selection only)	<input type="checkbox"/> Sensor redundancy / sensor backup (configured for increased availability) <input type="checkbox"/> Sensor drift monitoring ____°C / K sensor drift differential ____s time limit for drift overshoot <input type="checkbox"/> Differential measurement: sensor 1 - sensor 2 <input type="checkbox"/> Differential measurement: sensor 2 - sensor 1 <input type="checkbox"/> Average measurement
IEC 60751      Resistance thermometer	<input type="checkbox"/> Pt10 <input type="checkbox"/> Pt50 <input type="checkbox"/> Pt100 (Standard) <input type="checkbox"/> Pt200 <input type="checkbox"/> Pt500 <input type="checkbox"/> Pt1000
JIS C1604	<input type="checkbox"/> Pt10 <input type="checkbox"/> Pt50 <input type="checkbox"/> Pt100
MIL-T-24388	<input type="checkbox"/> Pt10 <input type="checkbox"/> Pt50 <input type="checkbox"/> Pt100 <input type="checkbox"/> Pt200 <input type="checkbox"/> Pt1000
DIN 43760	<input type="checkbox"/> Ni50 <input type="checkbox"/> Ni100 <input type="checkbox"/> Ni120 <input type="checkbox"/> Ni1000
OIML R 84	<input type="checkbox"/> Cu10 <input type="checkbox"/> Cu100
	Resistance measurement <input type="checkbox"/> 0 to 500 Ω <input type="checkbox"/> 0 to 5000 Ω
IEC 60584      Thermocouple	<input type="checkbox"/> Type K <input type="checkbox"/> Type J <input type="checkbox"/> Type N <input type="checkbox"/> Type R <input type="checkbox"/> Type S <input type="checkbox"/> Type T <input type="checkbox"/> Type E <input type="checkbox"/> Type B
DIN 43710	<input type="checkbox"/> Type L <input type="checkbox"/> Type U
IEC 60584 / ASTM E988	<input type="checkbox"/> Type C
ASTM E988	<input type="checkbox"/> Type D
	Voltage measurement <input type="checkbox"/> -125 to 125 mV <input type="checkbox"/> -125 to 1100 mV
Sensor circuit (for resistance thermometer and resistance measurement only)	<input type="checkbox"/> Two-wire <input type="checkbox"/> Three-wire (standard) <input type="checkbox"/> Four-wire Two-wire circuit: Compensation of sensor-wire resistance max. 100 Ω <input type="checkbox"/> Sensor 1: ____ Ω <input type="checkbox"/> Sensor 2: ____ Ω
Reference junction (for thermocouples only)	<input type="checkbox"/> Internal (for standard thermocouple, except type B) <input type="checkbox"/> None (type B) <input type="checkbox"/> External / temperature: ____°C
Meas. range	<input type="checkbox"/> Start of measuring range: _____ (default: 0) <input type="checkbox"/> End of measuring range: _____ (default: 100)
Unit	<input type="checkbox"/> Celsius (default) <input type="checkbox"/> Fahrenheit <input type="checkbox"/> Rankine <input type="checkbox"/> Kelvin
Characteristic behavior	<input type="checkbox"/> rising 4 to 20 mA (standard) <input type="checkbox"/> falling 20 to 4 mA
Output behavior for error	
Before SW-Rev. 3.00:	<input type="checkbox"/> Overrange / high alarm 22 mA (default) <input type="checkbox"/> Underrange / low alarm 3.6 mA
From SW-Rev. 3.00:	<input type="checkbox"/> Underrange / low alarm 3.5 mA (default) <input type="checkbox"/> Overrange / high alarm 22 mA
Output damping (T <sub>63</sub> )	<input type="checkbox"/> Off (standard) <input type="checkbox"/> ____ seconds (1 to 100 s)
Sensor number	<input type="checkbox"/> Sensor 1: _____ <input type="checkbox"/> Sensor 2: _____
Resistor value at 0 °C / R <sub>0</sub>	Sensor 1: R <sub>0</sub> : _____      Sensor 2: R <sub>0</sub> : _____
Callendar-Van Dusen coefficient A	A: _____      A: _____
Callendar-Van Dusen coefficient B	B: _____      B: _____
Callendar-Van Dusen coefficient C	C: _____      C: _____
(optional, for resistance thermometers only)	
User characteristics based on linearization table	<input type="checkbox"/> Based on attached table of variate pairs
TAG number	<input type="checkbox"/> _____ (maximum 8 characters)
HART revision:	
SW-Rev. 1.03	<input type="checkbox"/> HART5 (default) <input type="checkbox"/> HART7
From SW-Rev. 3.00	<input type="checkbox"/> HART5 <input type="checkbox"/> HART7 (default)
Software write protection	<input type="checkbox"/> Off (standard) <input type="checkbox"/> On
"Maintenance required" alarm impulse	
To SW-Rev. 1.03	<input type="checkbox"/> Off (default) Pulse width ____ s (0.5 to 59.5 s increment 0.5 s)
From SW-Rev. 3.00	<input type="checkbox"/> Off (default) Pulse width (1 to 127 seconds) ____ s (step size 1 s) Pulse repetition rate (60 to 86400 seconds / 1 day) ____ s (step size 1 s)



**PROFIBUS PA® / FOUNDATION Fieldbus® Device version**

Customer-specific configuration		Selection							
Number of sensors		<input type="checkbox"/> 1 sensor (standard)	<input type="checkbox"/> 2 sensors						
Measurement type (for 2-sensor selection only)		<input type="checkbox"/> Sensor redundancy / sensor backup <input type="checkbox"/> Sensor drift monitoring ____°C / K sensor drift differential ____s time limit for drift overshoot <input type="checkbox"/> Differential measurement: sensor 1 - sensor 2 <input type="checkbox"/> Differential measurement: sensor 2 - sensor 1 <input type="checkbox"/> Average measurement							
IEC 60751	Resistance thermometer	<input type="checkbox"/> Pt10	<input type="checkbox"/> Pt50	<input type="checkbox"/> Pt100 (Standard)	<input type="checkbox"/> Pt200	<input type="checkbox"/> Pt500	<input type="checkbox"/> Pt1000		
JIS C1604		<input type="checkbox"/> Pt10	<input type="checkbox"/> Pt50	<input type="checkbox"/> Pt100					
MIL-T-24388		<input type="checkbox"/> Pt10	<input type="checkbox"/> Pt50	<input type="checkbox"/> Pt100	<input type="checkbox"/> Pt200	<input type="checkbox"/> Pt1000			
DIN 43760		<input type="checkbox"/> Ni50	<input type="checkbox"/> Ni100	<input type="checkbox"/> Ni120	<input type="checkbox"/> Ni1000				
OIML R 84		<input type="checkbox"/> Cu10	<input type="checkbox"/> Cu100						
Resistance measurement		<input type="checkbox"/> 0 to 500 Ω	<input type="checkbox"/> 0 to 5000 Ω						
IEC 60584	Thermocouple	<input type="checkbox"/> Type K	<input type="checkbox"/> Type J	<input type="checkbox"/> Type N	<input type="checkbox"/> Type R	<input type="checkbox"/> Type S	<input type="checkbox"/> Type T	<input type="checkbox"/> Type E	<input type="checkbox"/> Type B
DIN 43710		<input type="checkbox"/> Type L	<input type="checkbox"/> Type U						
ASTM E-988		<input type="checkbox"/> Type C	<input type="checkbox"/> Type D						
Voltage measurement		<input type="checkbox"/> -125 to 125 mV	<input type="checkbox"/> -125 to 1100 mV						
Sensor circuit (for resistance thermometer and resistance measurement only)		<input type="checkbox"/> Two-wire <input type="checkbox"/> Three-wire (standard) <input type="checkbox"/> Four-wire Two-wire circuit: Compensation of sensor-wire resistance max. 100 Ω <input type="checkbox"/> <input type="checkbox"/> Sensor 1: ____ Ω <input type="checkbox"/> Sensor 2: ____ Ω							
Reference junction (for thermocouples only)		<input type="checkbox"/> Internal (for standard thermocouple, except type B) <input type="checkbox"/> None (type B) <input type="checkbox"/> External / temperature: ____°C							
Unit		<input type="checkbox"/> Celsius (default) <input type="checkbox"/> Fahrenheit <input type="checkbox"/> Rankine <input type="checkbox"/> Kelvin							
Resistor value at 0 °C / R <sub>0</sub>		Sensor 1: R <sub>0</sub> : _____		Sensor 2: R <sub>0</sub> : _____					
Callendar-Van Dusen coefficient A		A: _____		A: _____					
Callendar-Van Dusen coefficient B		B: _____		B: _____					
Callendar-Van Dusen coefficient C (optional, for resistance thermometers only)		C: _____		C: _____					
IDENT_number (PROFIBUS)		<input type="checkbox"/> device-specific 0x3470 (standard)			<input type="checkbox"/> profile 0x9700 (1 AI Block)				
Bus address PROFIBUS PA		<input type="checkbox"/> PA: 0 to 125			<input type="checkbox"/> Standard PA: 126				
TAG number		<input type="checkbox"/> _____ (maximum 16 characters)							
Software write protection		<input type="checkbox"/> Off (standard)			<input type="checkbox"/> On				

---

## Trademarks

HART is a registered trademark of FieldComm Group, Austin, Texas, USA

PROFIBUS and PROFIBUS PA are registered trademarks of PROFIBUS & PROFINET International (PI)

FOUNDATION Fieldbus is a registered trademark of FieldComm Group, Austin, Texas, USA.

Sales



Service





---

## **ABB Measurement & Analytics**

For your local ABB contact, visit:

**[www.abb.com/contacts](http://www.abb.com/contacts)**

For more product information, visit:

**[www.abb.com/temperature](http://www.abb.com/temperature)**

---

We reserve the right to make technical changes or modify the contents of this document without prior notice. With regard to purchase orders, the agreed particulars shall prevail. ABB does not accept any responsibility whatsoever for potential errors or possible lack of information in this document.

We reserve all rights in this document and in the subject matter and illustrations contained therein. Any reproduction, disclosure to third parties or utilization of its contents – in whole or in parts – is forbidden without prior written consent of ABB.