



# V 12-2 Miniature photoelectric switches: innovations in M12 housings

	Photoelectric proximity switches
	Photoelectric reflex switches
	Through-beam photoelectric switches



The V 12-2 photoelectric switch series in round miniature housings provides more than “just” extensive scanning ranges.

V 12-2 sensors are the ideal option for standard applications where space is restricted. In addition, V 12-2 photoelectric switches are the perfect complement to inductive or capacitive sensors in M12 housings.

Special focal points are applications in:

- The packaging and printing industries,
- assembly and handling systems,
- conveyor systems, and
- the construction of special-purpose machines.

The V 12-2 optic sensors and their ranges in overview:

- VS/VE 12-2 through-beam photoelectric switch: 5 m,
- VL 12-2 photoelectric reflex switch: 2.8 m (PL 80 A), switching reliability even with reflecting objects thanks to polarization filter and red LED transmitter.
- VT 12-2 photoelectric proximity switch, energetic: two scanning ranges scr. 300 mm and scr. 100 mm (90 % remission), manual sensitivity setting per Teach-in button and electronically per control input C.

Two Teach-in modes provide simple optimization options for VT 12T-2:

- Substantial operating reserve for standard applications,
- precise switching point and small hysteresis for special tasks,
- optical display of the operating reserve (alarm display) by blinking LED indicator.

Flexible and minimum variants in spite of this: Freely selectable switching type light-switching (L.ON) or dark-switching (D.ON) per control line.

$V_S = 10 \dots 30 \text{ V DC}$ ; switching output Q either in PNP or NPN; M12 plug or cable, IP 67 and sturdy metal housing are additional V 12-2 system strengths.

► Detecting objects on conveyor belts using VS/VE 12-2 through-beam photoelectric switches.

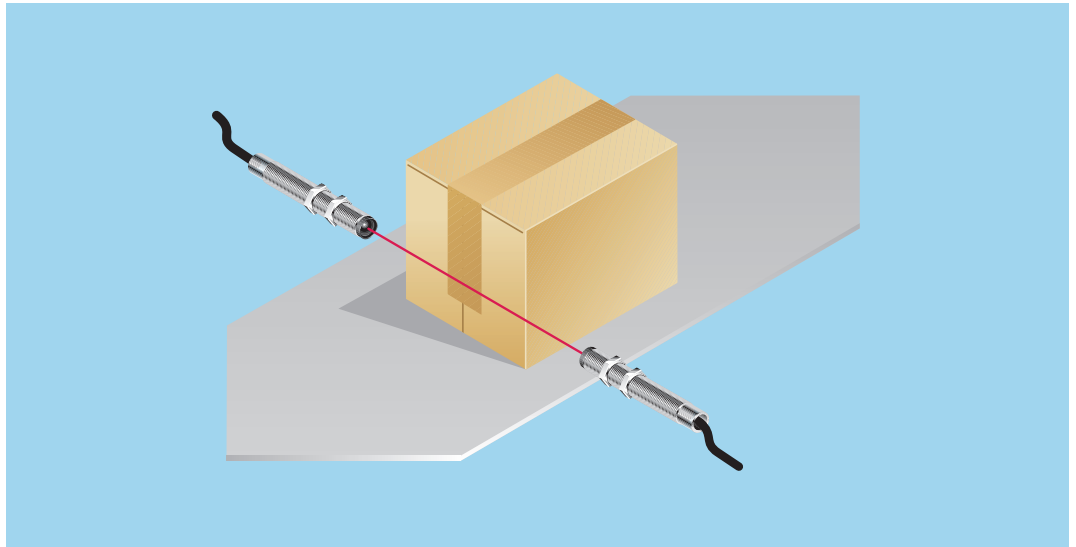

▼ VL 12-2 photoelectric reflex switches can also be used for the reliable detection of reflective surfaces, for example film-wrapped cardboard boxes.

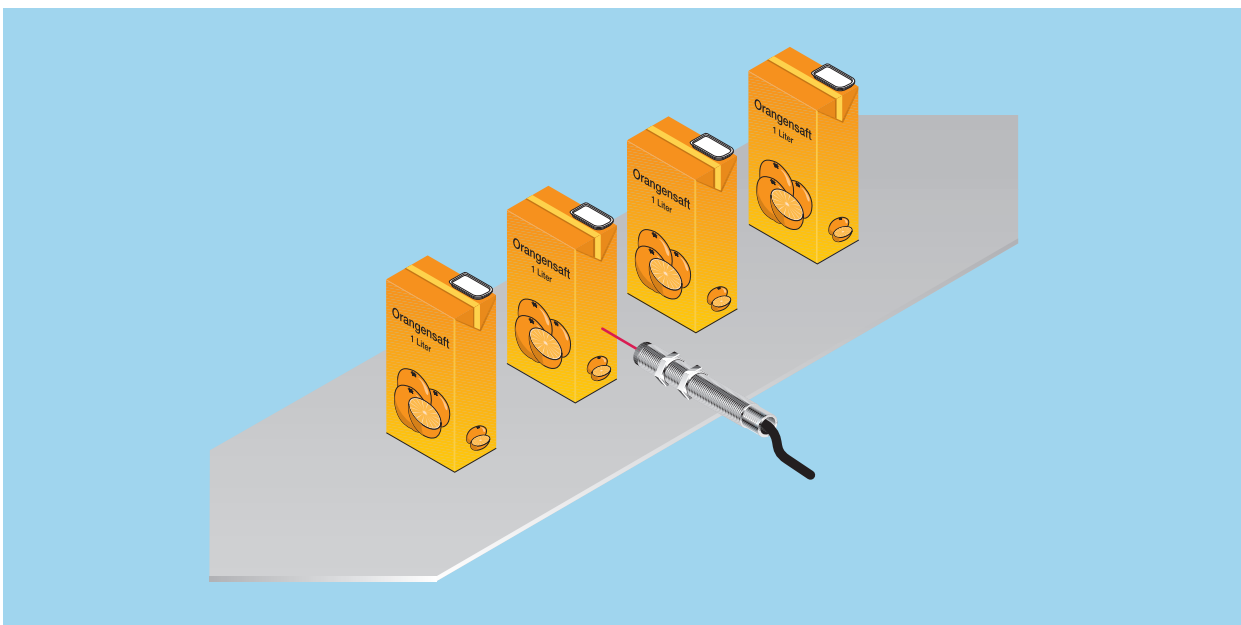
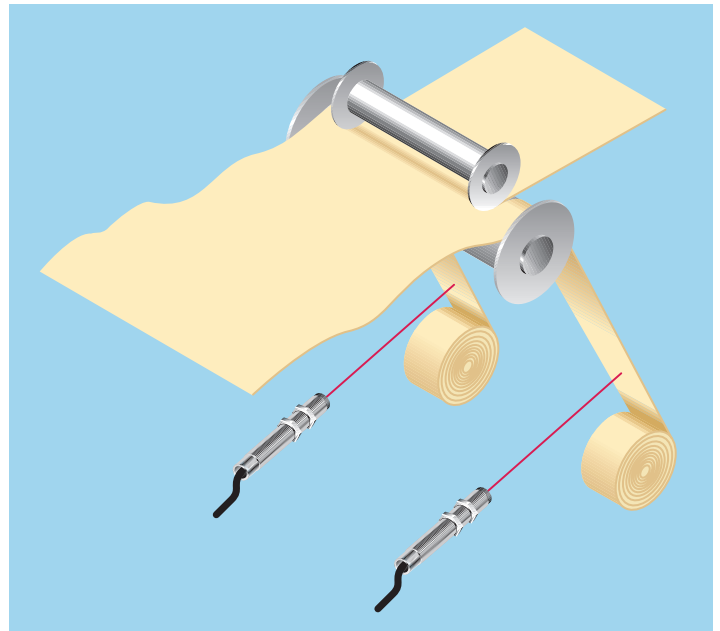
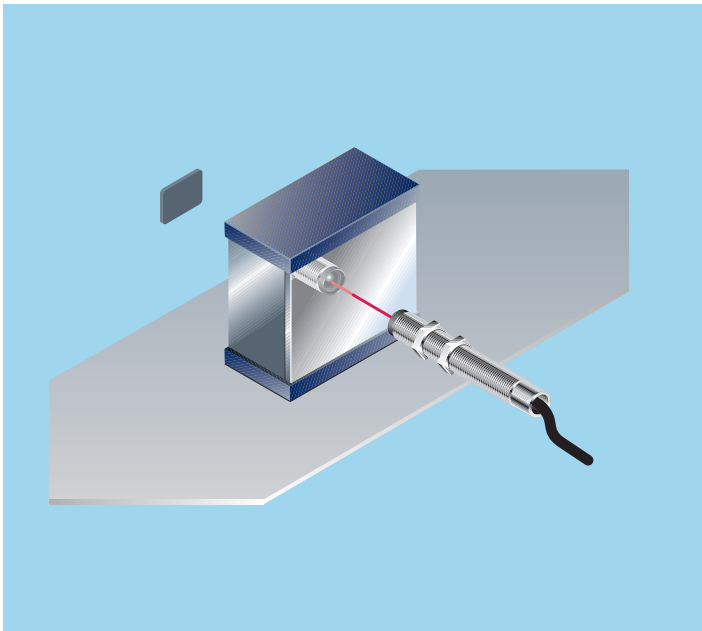

▲ VT 12-2 photoelectric proximity switches used to ensure that waste is rolled up correctly when paper and film strips are cut.

◀ Is an object present or not? The VT 12-2 photoelectric proximity switch provides the answer.

**Scanning distance**  
 0 ... 115 mm  
 0 ... 340 mm

Photoelectric proximity switches

- Sensitivity (scanning range) can be set per Teach-in at the “push of a button” or per control input C
- Minimum number of variants: Switching type L.ON or D.ON selectable per control input C
- Optic pre-failure message via operating reserve display

**Maßbild**

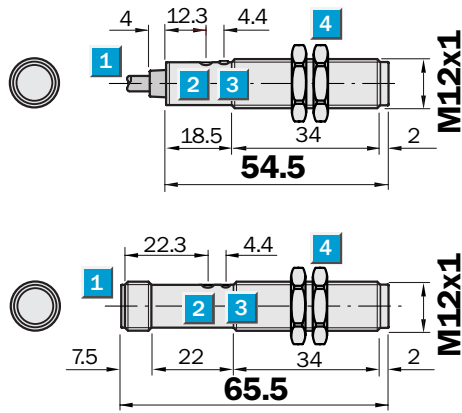

**Adjustments possible VT 12T-2**

VT 12T-2P 112	VT 12T-2N 112
VT 12T-2P 410	VT 12T-2N 410
VT 12T-2P 132	VT 12T-2N 132
VT 12T-2P 430	VT 12T-2N 430

- 1 Cable or plug M12, 4-pin
- 2 Sensitivity adjustment (Teach-in button)
- 3 Yellow LED indicator:  
 – lights continuously: reception signal > reserve factor 2  
 – blinks: Reception signal < reserve factor 2 but > switching threshold 1
- 4 Mounting nuts (2x), SW 17, metal

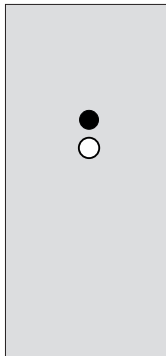

**Connection types**

VT 12T-2P 112	VT 12T-2P 410
VT 12T-2N 112	VT 12T-2N 410
VT 12T-2P 132	VT 12T-2P 430
VT 12T-2N 132	VT 12T-2N 430

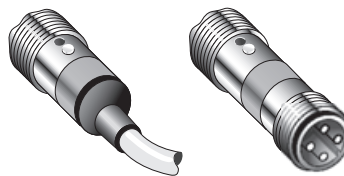

4 x 0.14 mm<sup>2</sup>      4-pin, M12

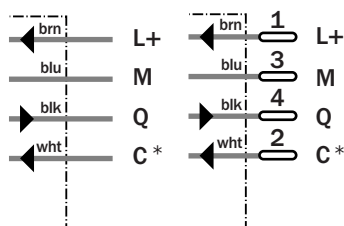

\* Control input C, programming:  
 – Switching type L.ON/D.ON and  
 – External Teach-in  
 C = open (not assigned)  
 light-switching L.ON  
 C = + V<sub>S</sub>: dark-switching D.ON  
 C = 0 V: sensitivity setting per  
 “external Teach-in” active



**See chapter Accessories**  
 Cables and connectors  
 Mounting systems

Technical data		VT 12T-2	P 112	P 410	N 112	N 410	P 132	P 430	N 132	N 430
<b>Scanning distance</b> , max. typical <sup>1)</sup>	0 ... 115 mm									
	0 ... 340 mm									
<b>Operating distance</b> <sup>1)</sup>	2 ... 100 mm									
	2 ... 300 mm									
<b>Sensitivity setting</b>	Manual, per Teach-in button									
	Electronic, per control input C (0 V) <sup>2)</sup>									
<b>Light source</b> <sup>3)</sup> , <b>light type</b>	LED, infrared light									
<b>Light spot diameter</b>	Approx. 20 mm at 100 mm									
	Approx. 28 mm at 300 mm									
<b>Angle of dispersion of sender</b>	Approx. 11.4° (SD = max.),									
	Approx. 22.6° (SD = 1/2 max.)									
	Approx. 5.3° (SD = max.),									
	Approx. 11.2° (SD = 1/2 max.)									
<b>Supply voltage</b> $V_S$	10 ... 30 V DC <sup>4)</sup>									
<b>Ripple</b> <sup>5)</sup>	≤ 10 %									
<b>Current consumption</b> <sup>6)</sup>	≤ 20 mA									
<b>Switching outputs</b>	Q: PNP									
	Q: NPN									
<b>Output current</b> $I_A$ max.	≤ 100 mA									
<b>Switching mode</b>	Light-/Dark-switching selectable <sup>2)</sup>									
<b>Response time</b> <sup>7)</sup>	≤ 1.25 ms									
<b>Switching frequency</b> max. <sup>8)</sup>	400/s									
<b>Connection types</b>	Cable <sup>9)</sup>	PVC, 2 m, 4 x 0.14 mm <sup>2</sup> , Ø 3.75 mm								
	Plug	M12, 4-pin								
<b>VDE protection class</b> <sup>10)</sup>	□									
<b>Circuit protection</b> <sup>11)</sup>	A, B, C, D									
<b>Enclosure rating</b>	IP 67									
<b>Ambient temperature</b> $T_A$	Operation	- 25 °C ... + 70 °C								
	Storage	- 25 °C ... + 70 °C								
<b>Weight</b>	With cable	Approx. 54 g								
	With plug	Approx. 18 g								
<b>Housing material</b>	Housing:	Nickel-coated brass/PA								
	Optics:	PC								

<sup>1)</sup> Object to be detected with 90 % remission (relating to standard white in acc. with DIN 5033); 100 x 100 mm

<sup>2)</sup> Control input C  
 - L.ON/D.ON and  
 - external Teach-in  
 C = open: light-switching L.ON  
 C = +  $V_S$ : dark-switching D.ON  
 C = 0 V: Sensitivity setting per "external Teach-in" active

<sup>3)</sup> Average service life 100,000 h at  $T_A = + 25 °C$

<sup>4)</sup> Limit values

<sup>5)</sup> May not exceed or fall short of  $V_S$  tolerances

<sup>6)</sup> Without load

<sup>7)</sup> Signal transit time with resistive load

<sup>8)</sup> With light/dark ratio 1:1

<sup>9)</sup> Do not bend below 0 °C

<sup>10)</sup> Reference voltage 50 V DC

<sup>11)</sup> A =  $V_S$  connections reverse-polarity protected

B = Inputs and output reverse-polarity protected

C = Interference pulse suppression

D = Outputs overload and short-circuit protected

**115 mm Scanning distance**

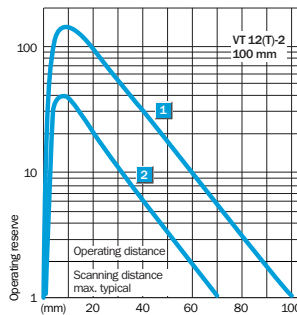
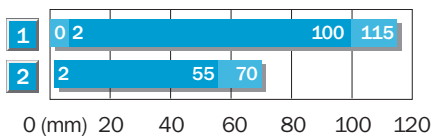

**340 mm Scanning distance**

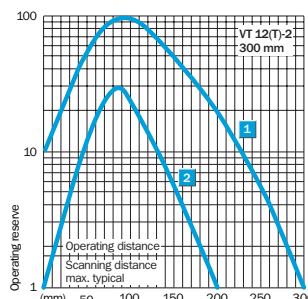
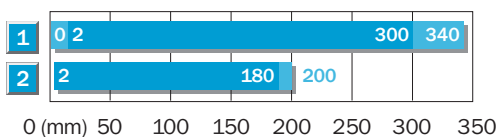

■ Operating distance ■ Scanning distance, max. typical

- 1 Scanning distance on white, 90 % remission
- 2 Scanning distance on grey, 18 % remission

**Order information**

Type	Order no.
VT 12T-2P 112	6 026 211
VT 12T-2P 410	6 026 212
VT 12T-2N 112	6 026 209
VT 12T-2N 410	6 026 210
VT 12T-2P 132	6 026 215
VT 12T-2P 430	6 026 216
VT 12T-2N 132	6 026 213
VT 12T-2N 430	6 026 214

	<b>Scanning range</b> 0.03 ... 2.8 m
<b>Photoelectric reflex switches</b>	

- Switching reliability even with reflecting objects thanks to polarization filter and red light
- Minimum number of variants: Switching type L.ON or D.ON selectable per control line L/D
- Optic pre-failure message via operating reserve display

**Dimensional drawing**

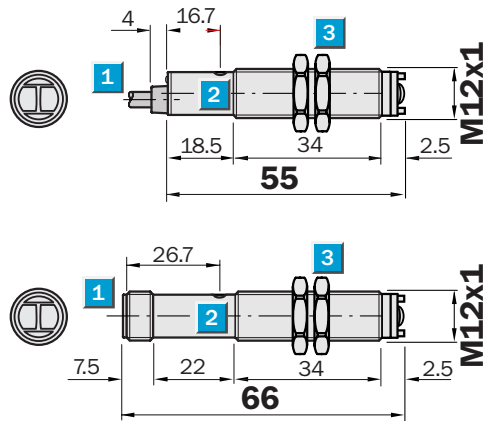

Adjustments possible	
VL 12-2P 132	VL 12-2N 132
VL 12-2P 430	VL 12-2N 430

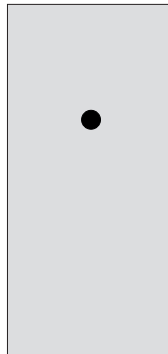

- 1 Cable or plug M12, 4-pin
- 2 Yellow LED indicator:
  - lights continuously: reception signal > reserve factor 2
  - blinks: Reception signal < reserve factor 2 but > switching threshold 1
- 3 Mounting nuts (2x), SW 17, metal



**Connection types**

VL 12-2P 132	VL 12-2P 430
VL 12-2N 132	VL 12-2N 430

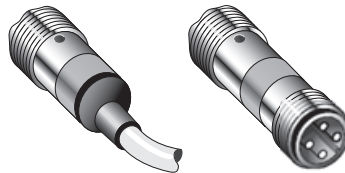

4 x 0.14 mm<sup>2</sup> | 4-pin, M12

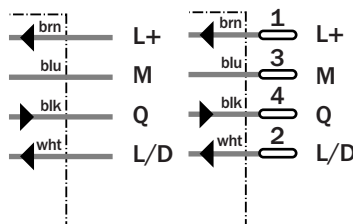

<b>See chapter Accessories</b>
Cables and connectors
Mounting systems

Technical data	VL 12-2	P 132	P 430	N 132	N 430					
----------------	---------	-------	-------	-------	-------	--	--	--	--	--

<b>Scanning range</b> , max. typ./reflector	0.03 ... 2.8 m/PL 80 A																				
Operating range	0.03 ... 2.3 m/PL 80 A																				
Sensitivity setting	Not available																				
<b>Light source<sup>1)</sup>, light type</b>	LED, red light, with polarization filter																				
Light spot diameter	Approx. 80 mm at 2 m																				
Angle of dispersion of sender	Approx. 2.3° (SR = max.), Approx. 6.3° (SR = 1/2 max.)																				
<b>Supply voltage V<sub>S</sub></b>	10 ... 30 V DC <sup>2)</sup>																				
Ripple <sup>3)</sup>	≤ 10%																				
Current consumption <sup>4)</sup>	≤ 20 mA																				
<b>Switching outputs</b>	Q: PNP																				
	Q: NPN																				
Output current I <sub>A</sub> max.	≤ 100 mA																				
Switching mode	Light-/Dark-switching selectable <sup>5)</sup>																				
Response time <sup>6)</sup>	≤ 1.25 ms																				
Switching frequency max. <sup>7)</sup>	400/s																				
<b>Connection types</b>	Cable <sup>8)</sup>	PVC, 2 m, 4 x 0.14 mm <sup>2</sup> , Ø 3.75 mm																			
	Plug	M12, 4-pin																			
<b>VDE protection class<sup>9)</sup></b>	□																				
<b>Circuit protection<sup>10)</sup></b>	A, B, C, D																				
<b>Enclosure rating</b>	IP 67																				
<b>Ambient temperature T<sub>A</sub></b>	Operation	- 25 °C ... + 70 °C																			
	Storage	- 25 °C ... + 70 °C																			
<b>Weight</b>	With cable	Approx. 54 g																			
	With plug	Approx. 18 g																			
<b>Housing material</b>	Housing:	Nickel-coated brass/PA																			
	Optics:	PC																			

<sup>1)</sup> Average service life 100,000 h  
at T<sub>A</sub> = + 25 °C

<sup>2)</sup> Limit values

<sup>3)</sup> May not exceed or fall short of  
V<sub>S</sub> tolerances

<sup>4)</sup> Without load

<sup>5)</sup> L/D switching type control line

L/D = open (not assigned)  
dark-switching D.ON

L/D = + V<sub>S</sub>: light-switching L.ON

L/D = 0 V: dark-switching D.ON

<sup>6)</sup> Signal transit time with resistive load

<sup>7)</sup> With light/dark ratio 1:1

<sup>8)</sup> Do not bend below 0 °C

<sup>9)</sup> Reference voltage 50 V DC

<sup>10)</sup> A = V<sub>S</sub> connections reverse-polarity  
protected

B = Inputs and output reverse-polarity  
protected

C = Interference pulse suppression

D = Outputs overload and short-circuit  
protected

### Scanning range and operating reserve

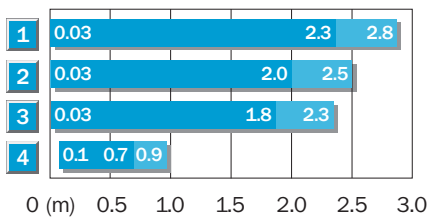

■ Operating range

■ Scanning range, max. typical

Reflector type	Operating range
1 PL 80 A	0.03 ... 2.3 m
2 C 110	0.03 ... 2.0 m
3 PL 50 A/PL 40 A/ P 250	0.03 ... 1.8 m
4 Reflective tape Diamond Grade	0.1 ... 0.7 m

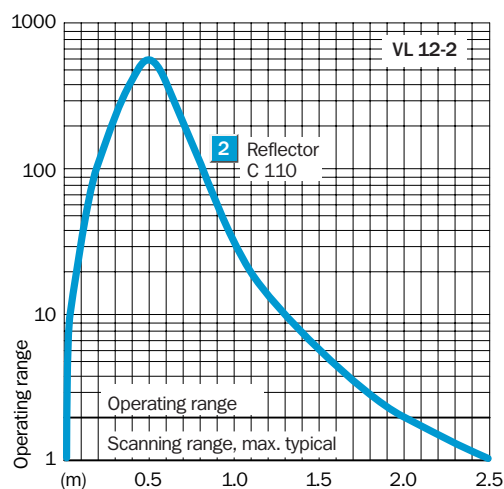

### Order information

Type	Order no.
VL 12-2P 132	6 026 219
VL 12-2P 430	6 026 220
VL 12-2N 132	6 026 217
VL 12-2N 430	6 026 218

 **Scanning range**  
0 ... 5.0 m

Through-beam photoelectric switches

- Minimum number of variants:  
Switching type L.ON or D.ON  
selectable per control line L/D
- Sturdy M12 metal housing,  
connection cable or M12 plug,  
4-pin

**Dimensional drawing**

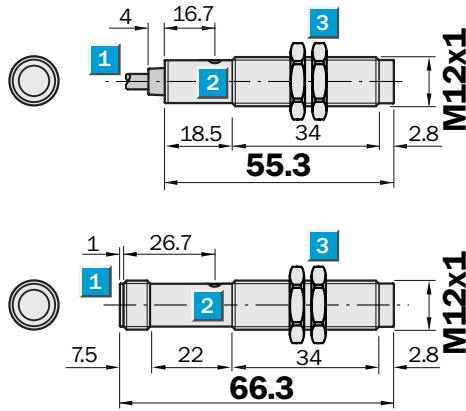

**Adjustments possible**

VS/VE 12-2P 132	VS/VE 12-2N 132
VS/VE 12-2P 430	VS/VE 12-2N 430

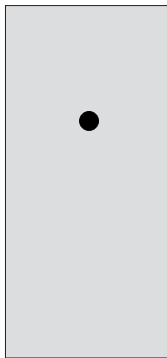

- 1** Cable or plug M12, 4-pin
- 2** Yellow LED indicator (continuously):  
Sender VS 12-2:  
– power on, sender active  
receiver VE 12-2:  
– light reception > switching threshold 1
- 3** Mounting nuts (2x), SW 17, metal

**Connection types**

VS/VE 12-2P 132	VS/VE 12-2P 430
VS/VE 12-2N 132	VS/VE 12-2N 430

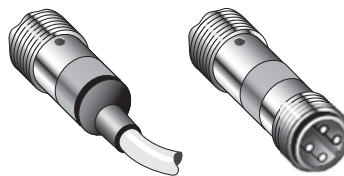

Sender	2 x 0.14 mm <sup>2</sup>	4-pin, M12
--------	--------------------------	------------

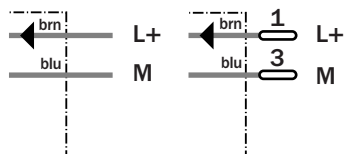

Receiver	4 x 0.14 mm <sup>2</sup>	4-pin, M12
----------	--------------------------	------------

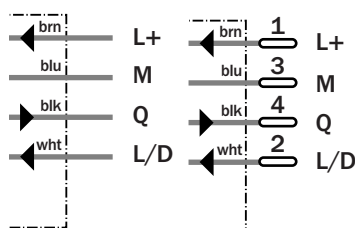

**See chapter Accessories**  
Cables and connectors  
Mounting systems



<b>Technical data</b>	VS/VE 12-2	P 132	P 430	N 132	N 430						
-----------------------	------------	-------	-------	-------	-------	--	--	--	--	--	--

<b>Scanning range, max. typ.</b>	0 ... 5.0 m										
Operating range	0 ... 4.0 m										
Sensitivity setting	Not available										
<b>Light source<sup>1)</sup>, light type</b>	LED, infrared light										
Light spot diameter	Approx. 100 mm at 4 m										
Angle of dispersion of sender	Approx. 1.4° (SR = max.),										
Angle of dispersion of receiver	Approx. 4.5° (SR = 1/2 max.)										
<b>Supply voltage V<sub>S</sub></b>	10 ... 30 V DC <sup>2)</sup>										
Ripple <sup>3)</sup>	≤ 10%										
Current consumption <sup>4)</sup>	≤ 20 mA										
<b>Switching outputs</b>	Q: PNP										
	Q: NPN										
Output current I <sub>A</sub> max.	≤ 100 mA										
Switching mode	Light-/Dark-switching selectable <sup>5)</sup>										
Response time <sup>6)</sup>	≤ 2.0 ms										
Switching frequency max. <sup>7)</sup>	250/s										
<b>Connection types</b>											
Cable <sup>8)</sup> sender VS 12-2	PVC, 2 m, 2 x 0.14 mm <sup>2</sup> , Ø 3.75 mm										
Cable <sup>8)</sup> receiver VE 12-2	PVC, 2 m, 4 x 0.14 mm <sup>2</sup> , Ø 3.75 mm										
Plug	M12, 4-pin										
<b>VDE protection class<sup>9)</sup></b>	□										
<b>Circuit protection<sup>10)</sup></b>	A, B, C, D										
<b>Enclosure rating</b>	IP 67										
<b>Ambient temperature T<sub>A</sub></b>	Operation - 25 °C ... + 70 °C										
	Storage - 25 °C ... + 70 °C										
<b>Weight</b>	With cable VS and VE each approx. 54 g										
	With plug VS and VE each approx. 18 g										
<b>Housing material</b>	Housing: Nickel-coated brass/PA										
	Optics: PC										

1) Average service life 100,000 h at T<sub>A</sub> = + 25 °C  
 2) Limit values  
 3) May not exceed or fall short of V<sub>S</sub> tolerances  
 4) Without load

5) L/D switching type control line  
 L/D = open (not assigned) dark-switching D.ON  
 L/D = + V<sub>S</sub>: light-switching L.ON  
 L/D = 0 V: dark-switching D.ON

6) Signal transit time with resistive load  
 7) With light/dark ratio 1:1  
 8) Do not bend below 0 °C  
 9) Reference voltage 50 V DC

10) A = V<sub>S</sub> connections reverse-polarity protected  
 B = Inputs and output reverse-polarity protected  
 C = Interference pulse suppression  
 D = Outputs overload and short-circuit protected

**Scanning range and operating reserve**

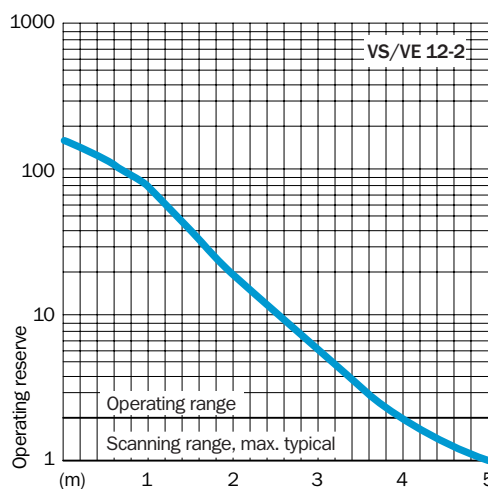
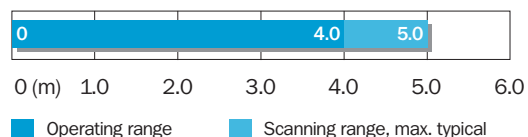

**Order information**

Type <sup>11)</sup>	Order no. <sup>11)</sup>
VS/VE 12-2P 132	6 026 223
VS/VE 12-2P 430	6 026 224
VS/VE 12-2N 132	6 026 221
VS/VE 12-2N 430	6 026 222

11) The order no. contains transmitter and receiver (= pair).